

UMA

5mmL, Standard, For General Purposes

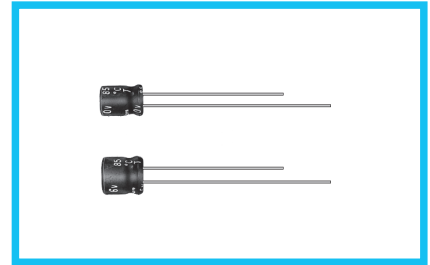

- Standard series with 5mm height.
- Compliant to the RoHS directive (2011/65/EU, (EU)2015/863).



Specifications

Item	Performance Characteristics																							
Category Temperature Range	-40 to +85°C																							
Rated Voltage Range	4 to 50V																							
Rated Capacitance Range	1 to 470μF																							
Rated Capacitance Tolerance	±20% at 120Hz, 20°C																							
Leakage Current	After 2 minutes' application of rated voltage at 20°C, leakage current is not more than 0.01CV or 3(μA), whichever is greater.																							
Tangent of loss angle (tan δ)	Measurement frequency : 120Hz at 20°C																							
	<table border="1"> <tr> <td>Rated voltage (V)</td> <td>4</td> <td>6.3</td> <td>10</td> <td>16</td> <td>25</td> <td>35</td> <td>50</td> <td rowspan="2">Figures in () are for UMR.</td> </tr> <tr> <td>tan δ (MAX.)</td> <td>0.35</td> <td>0.24 (0.30)</td> <td>0.20 (0.24)</td> <td>0.16 (0.20)</td> <td>0.14 (0.18)</td> <td>0.12 (0.16)</td> <td>0.10 (0.13)</td> </tr> </table>	Rated voltage (V)	4	6.3	10	16	25	35	50	Figures in () are for UMR.	tan δ (MAX.)	0.35	0.24 (0.30)	0.20 (0.24)	0.16 (0.20)	0.14 (0.18)	0.12 (0.16)	0.10 (0.13)						
Rated voltage (V)	4	6.3	10	16	25	35	50	Figures in () are for UMR.																
tan δ (MAX.)	0.35	0.24 (0.30)	0.20 (0.24)	0.16 (0.20)	0.14 (0.18)	0.12 (0.16)	0.10 (0.13)																	
Stability at Low Temperature	Measurement frequency : 120Hz																							
	<table border="1"> <tr> <td>Rated voltage (V)</td> <td>4</td> <td>6.3</td> <td>10</td> <td>16</td> <td>25</td> <td>35</td> <td>50</td> </tr> <tr> <td>Impedance ratio Z-25°C / Z+20°C (MAX.)</td> <td>7</td> <td>4</td> <td>3</td> <td>2</td> <td>2</td> <td>2</td> <td>2</td> </tr> <tr> <td>Z-40°C / Z+20°C</td> <td>15</td> <td>8</td> <td>6</td> <td>4</td> <td>4</td> <td>3</td> <td>3</td> </tr> </table>	Rated voltage (V)	4	6.3	10	16	25	35	50	Impedance ratio Z-25°C / Z+20°C (MAX.)	7	4	3	2	2	2	2	Z-40°C / Z+20°C	15	8	6	4	4	3
Rated voltage (V)	4	6.3	10	16	25	35	50																	
Impedance ratio Z-25°C / Z+20°C (MAX.)	7	4	3	2	2	2	2																	
Z-40°C / Z+20°C	15	8	6	4	4	3	3																	
Endurance	<p>The specifications listed at right shall be met when the capacitors are restored to 20°C after the rated voltage is applied for 2000 hours at 85°C.</p> <table border="1"> <tr> <td>Capacitance change</td> <td>Within ±20% of the initial capacitance value (UMR & φ3 product : Within ±25%)</td> </tr> <tr> <td>tan δ</td> <td>200% or less than the initial specified value</td> </tr> <tr> <td>Leakage current</td> <td>Less than or equal to the initial specified value</td> </tr> </table>	Capacitance change	Within ±20% of the initial capacitance value (UMR & φ3 product : Within ±25%)	tan δ	200% or less than the initial specified value	Leakage current	Less than or equal to the initial specified value																	
Capacitance change	Within ±20% of the initial capacitance value (UMR & φ3 product : Within ±25%)																							
tan δ	200% or less than the initial specified value																							
Leakage current	Less than or equal to the initial specified value																							
Shelf Life	After storing the capacitors under no load at 85°C for 1000 hours and then performing voltage treatment based on JIS C 5101-4 clause 4.1 at 20°C, they shall meet the specified values for the endurance characteristics listed above.																							
Marking	Printed with white color letter on black sleeve.																							

Radial Lead Type



● Please refer to page 20 about the end seal configuration.

Type numbering system (Example : 25V 10μF)

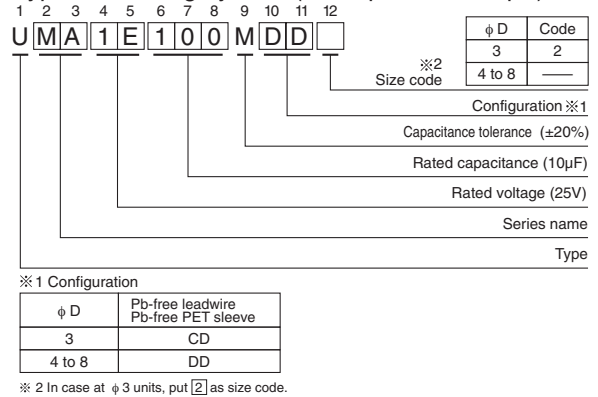

Dimensions

Cap. (μF)	Code	4		6.3		10		16		25		35		50	
		0G		0J		1A		1C		1E		1V		1H	
1	010														4×5(3×5) 8.4(8.0)
2.2	2R2														● 4×5 13(10)
3.3	3R3														4×5 17
4.7	4R7														5×5 20
10	100			3×5	15										● 4×5 23(18) 5×5 27 6.3×5 42
22	220	3×5	19	● 4×5	28(21)	5×5	33	5×5	37	6.3×5	42	6.3×5	46	□ 8×5	52(48)
33	330	4×5	28	5×5	37	5×5	41	○ 6.3×5	49(43)	6.3×5	52	□ 8×5	62(52)	8×5	71
47	470	4×5	33	5×5	45	○ 6.3×5	52(43)	6.3×5	58	□ 8×5	70(62)	8×5	80		
100	101	5×5	56	○ 6.3×5	70(68)	□ 8×5	80(76)	□ 8×5	92(86)	8×5	110				
220	221	6.3×5	96	□ 8×5	110(90)	8×5	135								
330	331	8×5	145	8×5	170										
470	471	8×5	185												

Size φ3 × 5 is available for capacitors marked. "●"/ Size φ5 × 5 is available for capacitors marked. "○"
 Size φ6.3 × 5 is available for capacitors marked. "□" In such a case, [M][R] will be put at 2nd and 3rd digit of type numbering system.

Rated ripple current (mA rms) at 85°C 120Hz
 () = φ3 units and UMR.

Frequency coefficient of rated ripple current

Frequency	50 Hz	120 Hz	300 Hz	1 kHz	10kHz or more
Coefficient	0.70	1.00	1.17	1.36	1.50

Please refer to page 20, 21, 22 about the formed or taped product spec.
 Please refer to page 4 for the minimum order quantity.



Компания «ЭлектроПласт» предлагает заключение долгосрочных отношений при поставках импортных электронных компонентов на взаимовыгодных условиях!

Наши преимущества:

- Оперативные поставки широкого спектра электронных компонентов отечественного и импортного производства напрямую от производителей и с крупнейших мировых складов;
- Поставка более 17-ти миллионов наименований электронных компонентов;
- Поставка сложных, дефицитных, либо снятых с производства позиций;
- Оперативные сроки поставки под заказ (от 5 рабочих дней);
- Экспресс доставка в любую точку России;
- Техническая поддержка проекта, помощь в подборе аналогов, поставка прототипов;
- Система менеджмента качества сертифицирована по Международному стандарту ISO 9001;
- Лицензия ФСБ на осуществление работ с использованием сведений, составляющих государственную тайну;
- Поставка специализированных компонентов (Xilinx, Altera, Analog Devices, Intersil, Interpoint, Microsemi, Aeroflex, Peregrine, Syfer, Eurofarad, Texas Instrument, Miteq, Cobham, E2V, MA-COM, Hittite, Mini-Circuits, General Dynamics и др.);

Помимо этого, одним из направлений компании «ЭлектроПласт» является направление «Источники питания». Мы предлагаем Вам помощь Конструкторского отдела:

- Подбор оптимального решения, техническое обоснование при выборе компонента;
- Подбор аналогов;
- Консультации по применению компонента;
- Поставка образцов и прототипов;
- Техническая поддержка проекта;
- Защита от снятия компонента с производства.



Как с нами связаться

Телефон: 8 (812) 309 58 32 (многоканальный)

Факс: 8 (812) 320-02-42

Электронная почта: org@eplast1.ru

Адрес: 198099, г. Санкт-Петербург, ул. Калинина, дом 2, корпус 4, литера А.