

# Triple Supply Monitor and $\mu$ P Supervisor with Adjustable Reset and Watchdog Timer

## FEATURES

- **Monitors Three Inputs Simultaneously**  
 LTC1726-5: 5V, 3.3V and ADJ  
 LTC1726-2.5: 2.5V, 3.3V and ADJ
- $\pm 1.5\%$  Threshold Accuracy Over Temperature
- **Low Supply Current: 16 $\mu$ A Typ**
- **Adjustable Reset Timeout**
- **Adjustable Watchdog Timeout**
- Active Low Open-Drain Reset Output
- Power Supply Glitch Immunity
- Guaranteed RESET for  $V_{CC3} \geq 1V$  or  $V_{CC25}/V_{CC5} \geq 1V$
- MS8 and SO-8 Packages

## APPLICATIONS

- Desktop Computers
- Notebook Computers
- Intelligent Instruments
- Portable Battery-Powered Equipment
- Network Servers

## DESCRIPTION

The LTC<sup>®</sup>1726 is a triple supply monitor and microprocessor supervisory circuit with adjustable reset and watchdog functions intended for systems with multiple supply voltages. The part has a common open-drain reset output with an adjustable delay. The reset and watchdog time-out periods are both adjustable using external capacitors.

Tight 1.5% accuracy specifications and glitch immunity ensure reliable reset operation without false triggering.

The  $\overline{RST}$  output is guaranteed to be in the correct state for  $V_{CC5}/V_{CC25}$  or  $V_{CC3}$  down to 1V. The LTC1726 may also be configured to monitor any one or two  $V_{CC}$  inputs instead of three, depending on system requirements.

The low (16 $\mu$ A typical) supply current makes the LTC1726 ideal for power-conscious systems.

LT, LT, LTC, LTM, Linear Technology and the Linear logo are registered trademarks and ThinSOT is a trademark of Linear Technology Corporation. All other trademarks are the property of their respective owners.

## TYPICAL APPLICATION

**A 3.3V, 5V and 1.8V Monitor**

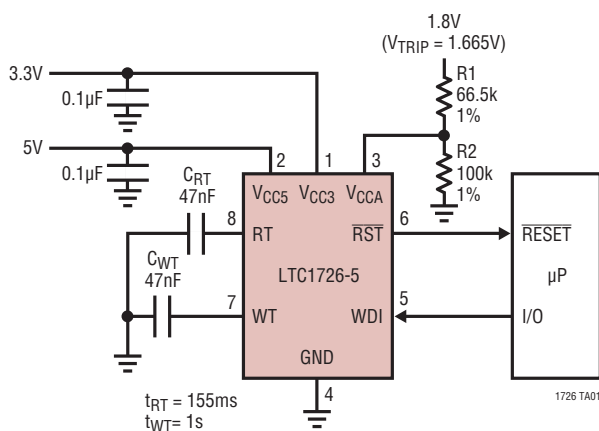

**A 3.3V, 2.5V and 1.8V Monitor**

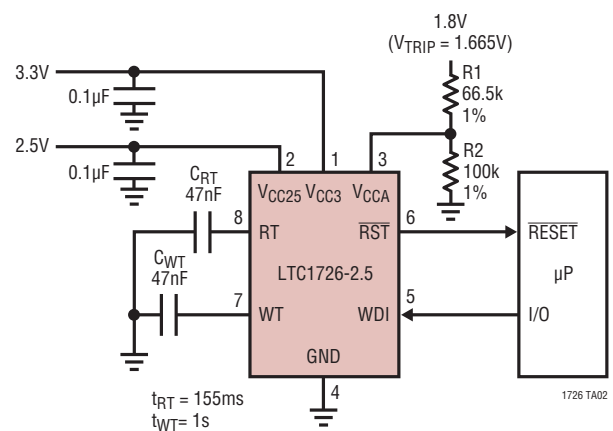

# LTC1726

## ABSOLUTE MAXIMUM RATINGS (Notes 1, 2)

### Terminal Voltage

$V_{CC3}$ , $V_{CC5}/V_{CC25}$ , $V_{CCA}$ .....	-0.3V to 7V
RST .....	-0.3V to 7V
WDI .....	-0.3V to 7V
RT, WT.....	-0.3V to 7V

### Operating Temperature Range (Note 3)

LTC1726E, LTC1726I.....	-40°C to 85°C
LTC1726H .....	-40°C to 125°C
Storage Temperature Range .....	-65°C to 150°C
Lead Temperature (Soldering, 10 sec).....	300°C

## PIN CONFIGURATION

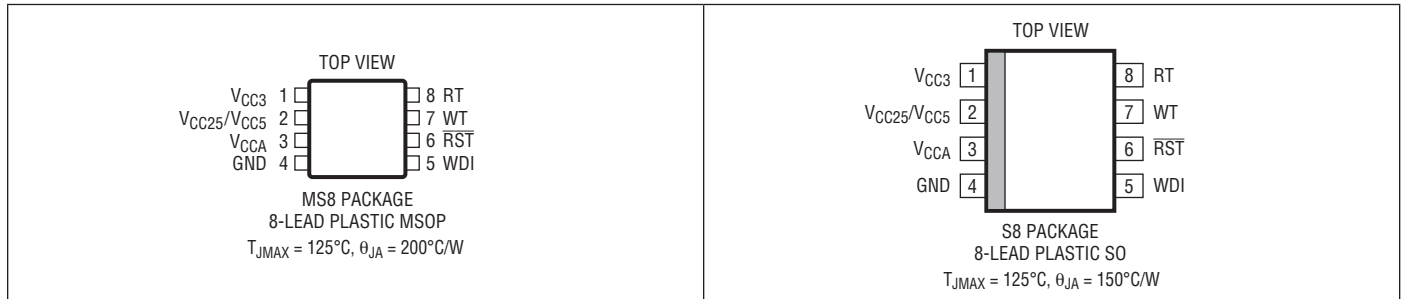

## ORDER INFORMATION

LEAD FREE FINISH	TAPE AND REEL	PART MARKING	PACKAGE DESCRIPTION	TEMPERATURE RANGE
LTC1726EMS8-2.5#PBF	LTC1726EMS8-2.5#TRPBF	LTKZ	8-Lead Plastic MSOP	-40°C to 85°C
LTC1726EMS8-5#PBF	LTC1726EMS8-5#TRPBF	LTLA	8-Lead Plastic MSOP	-40°C to 85°C
LTC1726HMS8-5#PBF	LTC1726HMS8-5#TRPBF	LTLA	8-Lead Plastic MSOP	-40°C to 125°C
LTC1726ES8-2.5#PBF	LTC1726ES8-2.5#TRPBF	172625	8-Lead Plastic SO	-40°C to 85°C
LTC1726ES8-5#PBF	LTC1726ES8-5#TRPBF	17265	8-Lead Plastic SO	-40°C to 85°C
LTC1726IS8-2.5#PBF	LTC1726IS8-2.5#TRPBF	726I25	8-Lead Plastic SO	-40°C to 85°C
LTC1726IS8-5#PBF	LTC1726IS8-5#TRPBF	1726I5	8-Lead Plastic SO	-40°C to 85°C

Consult LTC Marketing for parts specified with wider operating temperature ranges.

Consult LTC Marketing for information on non-standard lead based finish parts.

For more information on lead free part marking, go to: <http://www.linear.com/leadfree/>

For more information on tape and reel specifications, go to: <http://www.linear.com/tapeandreel/>

## ELECTRICAL CHARACTERISTICS

The ● denotes the specifications which apply over the full operating temperature range, otherwise specifications are at  $T_A = 25^\circ\text{C}$ .  $V_{CC3} = 3.3\text{V}$ ,  $V_{CC5} = 5\text{V}$ ,  $V_{CC25} = 2.5\text{V}$ ,  $V_{CCA} = V_{CC3}$  unless otherwise noted.

SYMBOL	PARAMETER	CONDITIONS	MIN	TYP	MAX	UNITS
$V_{RT3}$	Reset Threshold $V_{CC3}$	$V_{CC3}$ Input Threshold	● 3.036	3.085	3.135	V
		H-Grade	● 3.023	3.085	3.147	V
$V_{RT5}$	Reset Threshold $V_{CC5}$	$V_{CC5}$ Input Threshold (5V Version)	● 4.600	4.675	4.750	V
		H-Grade	● 4.582	4.675	4.769	V
$V_{RT25}$	Reset Threshold $V_{CC25}$	$V_{CC25}$ Input Threshold (2.5V Version),	● 2.300	2.337	2.375	V
$V_{RTA}$	Reset Threshold $V_{CCA}$	$V_{CCA}$ Input Threshold	● 0.985	1.000	1.015	V
		H-Grade	● 0.978	1.000	1.022	V
$V_{CC}$	$V_{CC3}$ or $V_{CC5}$ Operating Voltage	$\overline{\text{RST}}$ in Correct Logic State	● 1		7	V
$I_{VCC3}$	$V_{CC3}$ Supply Current	$V_{CC5}/V_{CC25} > V_{CC3}$	●	1	2	$\mu\text{A}$
		$V_{CC5}/V_{CC25} < V_{CC3}$ , $V_{CC3} = 3.3\text{V}$	●	16	30	$\mu\text{A}$
$I_{VCC5}$	$V_{CC5}$ Supply Current	$V_{CC5} = 5\text{V}$	●	16	30	$\mu\text{A}$
$I_{VCC25}$	$V_{CC25}$ Supply Current	$V_{CC25} < V_{CC3}$ , $V_{CC25} = 2.5\text{V}$ (Note 4)	●	1	2	$\mu\text{A}$
$I_{VCCA}$	$V_{CCA}$ Input Current	$V_{CCA} = 1\text{V}$	● -15	0	15	nA
		RT Charge Current Out	$V_{RT} = 0\text{V}$	● 1.4	2	2.6
		H-Grade	● 1.3	2	2.6	$\mu\text{A}$
	WT Charge Current Out	$V_{WT} = 0\text{V}$	● 1.4	2	2.6	$\mu\text{A}$
		H-Grade	● 1.3	2	2.6	$\mu\text{A}$
	RT Discharge Current Out	$V_{RT} = 1.3\text{V}$	● 14	20	26	$\mu\text{A}$
		H-Grade	● 13	20	28	$\mu\text{A}$
	WT Discharge Current Out	$V_{WT} = 1.3\text{V}$	● 14	20	26	$\mu\text{A}$
		H-Grade	● 13	20	28	$\mu\text{A}$
$\Delta t_{RT}$	Reset Time-Out Period Variation	$C_{RT} = 1500\text{pF}$ Deviation from $t_{RT} = 5\text{ms}$ (Note 5)	● -30	0	30	%
		H-Grade	● -45	0	45	%
$t_{UV}$	$V_{CC}$ Undervoltage Detect to $\overline{\text{RST}}$	$V_{CC25}/V_{CC5}$ , $V_{CC3}$ or $V_{CCA}$ Less Than Reset Threshold $V_{RT}$ by More Than 1%		130		$\mu\text{s}$
$V_{OH}$	$\overline{\text{RST}}$ Output Voltage High (Note 6)	$I_{SOURCE} = 1\mu\text{A}$	● $V_{CC3} - 1$			V
$V_{OL}$	$\overline{\text{RST}}$ Output Voltage Low	$I_{SINK} = 2.5\text{mA}$ , $V_{CC5}/V_{CC25} = 0\text{V}$	●	0.15	0.4	V
		$I_{SINK} = 100\mu\text{A}$ , $V_{CC3} = 1\text{V}$ , $V_{CC5}/V_{CC25} = 0\text{V}$	●	0.05	0.3	V
		$I_{SINK} = 100\mu\text{A}$ , $V_{CC3} = 0\text{V}$ , $V_{CC5}/V_{CC25} = 1\text{V}$	●	0.05	0.3	V
		$I_{SINK} = 100\mu\text{A}$ , $V_{CC3} = 1\text{V}$ , $V_{CC5}/V_{CC25} = 1\text{V}$	●	0.05	0.3	V
$V_{IH}$	WDI Input Threshold High			$0.7 \cdot V_{CC3}$		V
$V_{IL}$	WDI Input Threshold Low		● $0.3 \cdot V_{CC3}$			V
$t_{WP}$	WDI Pulse Width		● 40			ns
$\Delta t_{WT}$	Watchdog Time-Out Period Variation	$C_{WT} = 1500\text{pF}$ Deviation from $t_{WT} = 33\text{ms}$ (Note 5)	● -30	0	30	%
		H-Grade	● -45	0	45	%
	WDI Leakage Current				$\pm 1$	$\mu\text{A}$
<b>LTC1726-5 Only</b>						
$V_{OVR}$	$V_{CC5}$ Reset Override Voltage (Note 7)	Override $V_{CC5}$ Ability to Assert $\overline{\text{RST}}$		$V_{CC3} \pm 0.025$		V

## ELECTRICAL CHARACTERISTICS

**Note 1:** Stresses beyond those listed under Absolute Maximum Ratings may cause permanent damage to the device. Exposure to any Absolute Maximum Rating condition for extended periods may affect device reliability and lifetime.

**Note 2:** All voltage values are with respect to GND.

**Note 3:** The LTC1726E is guaranteed to meet performance specifications from 0°C to 70°C. Specifications over the -40°C to 85°C operating temperature range are assured by design, characterization and correlation with statistical process controls.

**Note 4:** Both  $V_{CC3}$  and  $V_{CC25}/V_{CC5}$  can act as the supply depending on which pin has the greatest potential.

**Note 5:** Timing measured with respect to  $\overline{RST}$  passing through 1.5V.

**Note 6:** The output pin  $\overline{RST}$  has a weak internal pull-up to  $V_{CC3}$  of typically 6 $\mu$ A. However, external pull-up resistors may be used when faster rise times are required or for  $V_{OH}$  voltages greater than  $V_{CC3}$ .

**Note 7:** The  $V_{CC5}$  reset override voltage is valid for an operating range less than approximately 4.15V. Above this point the override is turned off and the  $V_{CC5}$  pin functions normally.

## TYPICAL PERFORMANCE CHARACTERISTICS

**$V_{CC5}$  Threshold Voltage vs Temperature (LTC1726-5)**

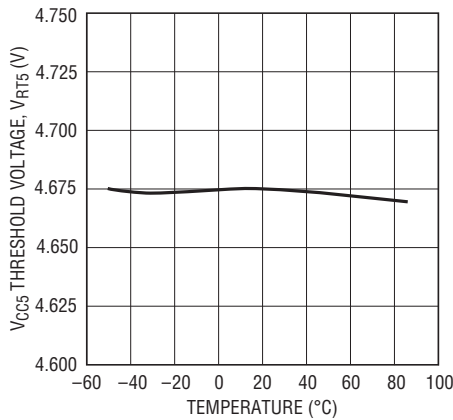

1726 G01

**$V_{CC3}$  Threshold Voltage vs Temperature**

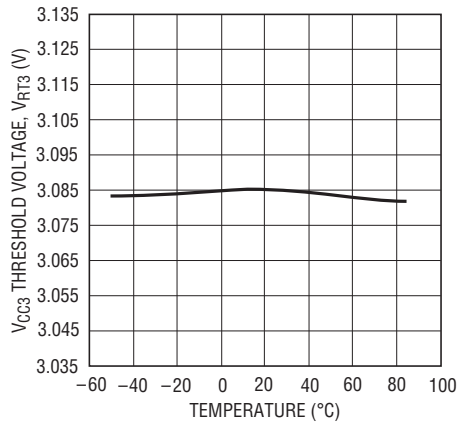

1726 G02

**$V_{CCA}$  Threshold Voltage vs Temperature**

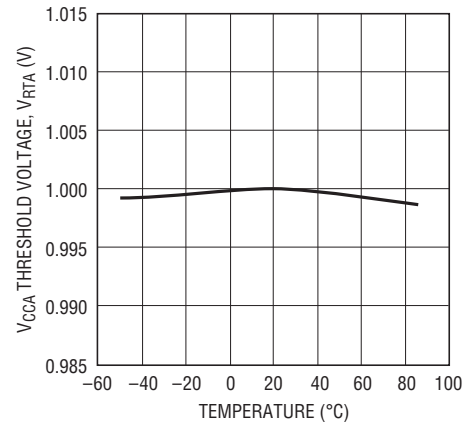

1726 G03

**$V_{CC25}$  Threshold Voltage vs Temperature (LTC1726-2.5)**

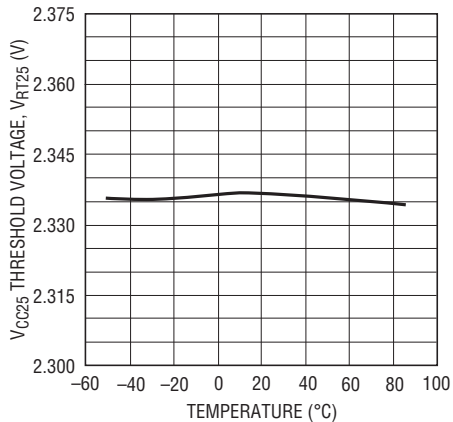

1726 G04

**$I_{VCC5}$  vs Temperature (LTC1726-5)**

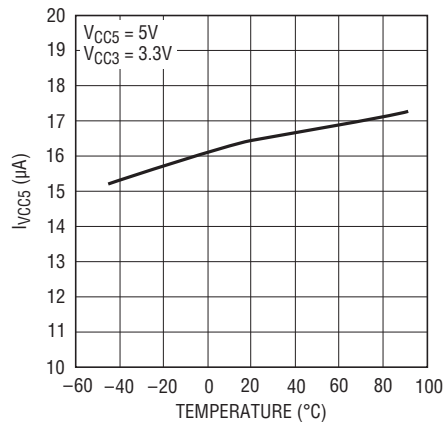

1726 G05

**$I_{VCC3}$  vs Temperature (LTC1726-5)**

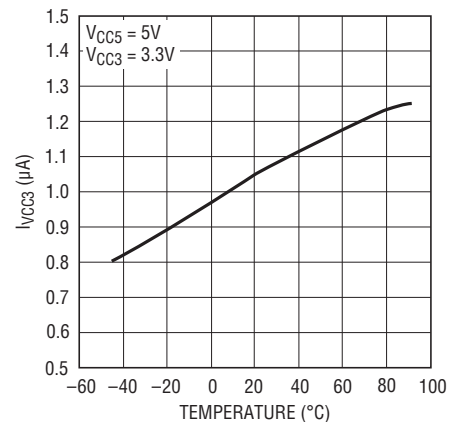

1726 G06

# TYPICAL PERFORMANCE CHARACTERISTICS

**I<sub>VCC25</sub> vs Temperature (LTC1726-2.5)**

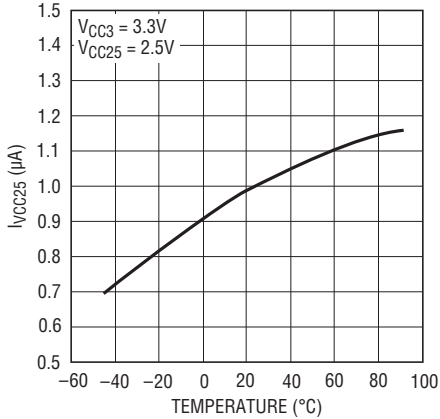

1726 G07

**I<sub>VCC3</sub> vs Temperature (LTC1726-2.5)**

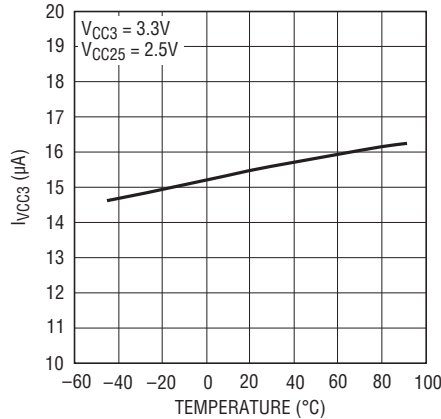

1726 G08

**Typical Transient Duration vs Comparator Overdrive**

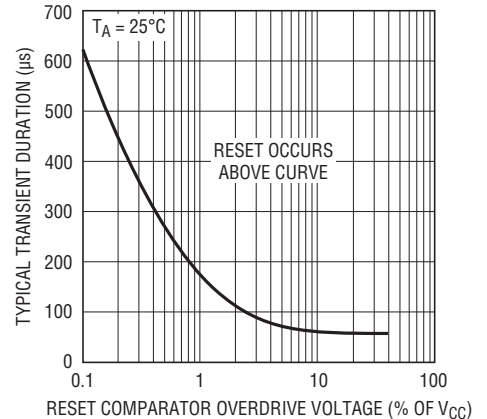

1726 G09

**V<sub>CCA</sub> Input Current vs Input Voltage**

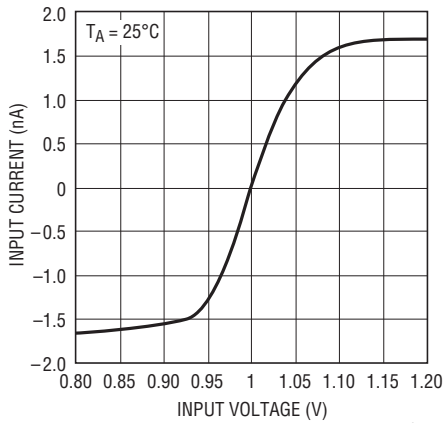

1726 G14

**Watchdog Time-Out Period vs Temperature**

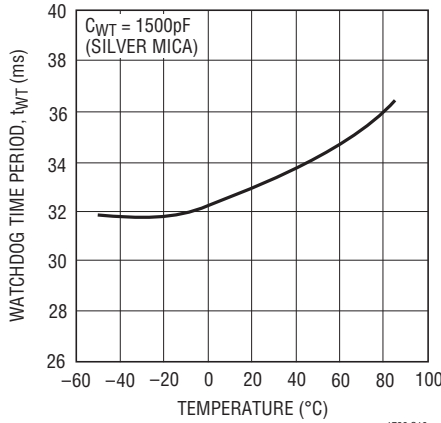

1726 G10

**Reset Pulse Width vs Temperature**

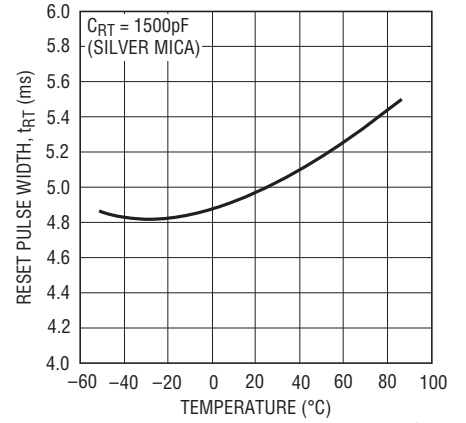

1726 G11

**Watchdog Time-Out Period vs Capacitance**

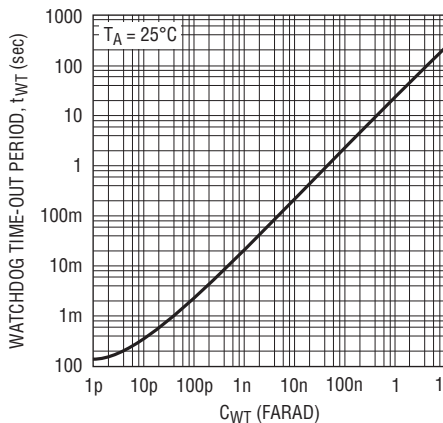

1726 G12

**Reset Time-Out Period vs Capacitance**

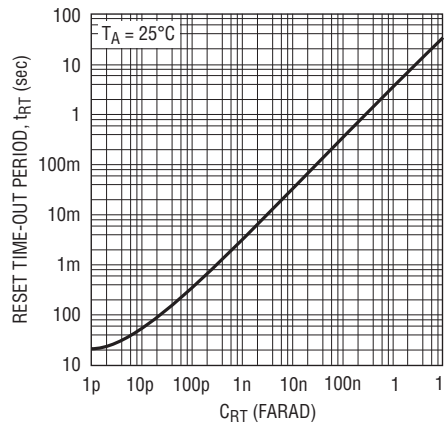

1726 G15

**R<sub>ST</sub> Output Voltage vs Supply Voltage (LTC1726-2.5)**

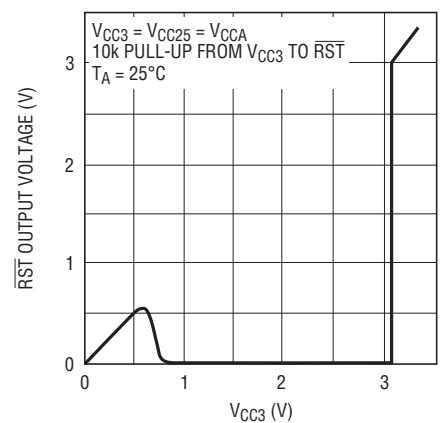

1726 F13

## PIN FUNCTIONS

**V<sub>CC3</sub> (Pin 1):** 3.3V Sense Input. This pin also supplies power to the part when the voltage on this pin is greater than the voltage on V<sub>CC25</sub>/V<sub>CC5</sub>. Bypass this pin to ground with a 0.1µF or larger ceramic capacitor.

**V<sub>CC5</sub> (Pin 2):** 5V Sense Input (LTC1726-5). This pin also supplies power to the part when the voltage on this pin is greater than the voltage on V<sub>CC3</sub>. Bypass this pin to ground with a 0.1µF or larger ceramic capacitor.

**V<sub>CC25</sub> (Pin 2):** 2.5V Sense Input (LTC1726-2.5). This pin also supplies power to the part when the voltage on this pin is greater than the voltage on V<sub>CC3</sub>. Bypass this pin to ground with a 0.1µF or larger ceramic capacitor.

**V<sub>CCA</sub> (Pin 3):** 1V Sense, High Impedance Input. If unused it can be tied to either V<sub>CC3</sub>, V<sub>CC5</sub> or V<sub>CC25</sub>.

**GND (Pin 4):** Ground.

**WDI (Pin 5):** Watchdog Input. A logic input whose rising or falling edge must occur on this pin within the selected watchdog time-out period or a reset pulse will occur. The watchdog time-out period is set by the value of the capacitor that is placed on the WT pin. The rising or falling edge of this pin clears the voltage on the WT capacitor, preventing a reset pulse from occurring. If the watchdog timer is not cleared, a reset pulse will occur. The watchdog timer is cleared during a reset and restarts when the reset is deasserted. When disabling the watchdog function, this

pin should be connected to either V<sub>CC3</sub> or ground and WT must be grounded.

**RST (Pin 6):** Reset Logic Output. Active low, open-drain logic output with weak pull-up to V<sub>CC3</sub>. Asserted when one or more of the supplies are below trip thresholds. After all supplies become valid, the reset remains asserted for the period set by the capacitor on the RT pin. The watchdog timer can also trigger the reset whenever the watchdog time-out period is exceeded. This pin can be pulled up greater than V<sub>CC3</sub> when interfacing to 5V logic.

**WT (Pin 7):** Watchdog Time-Out Input. Place a capacitor between this pin and ground to adjust the watchdog time-out period. To determine the watchdog time-out period:

$$t_{WT} = 21.8 \cdot C_{WT}$$

with  $t_{WT}$  in µs and  $C_{WT}$  in pF. As an example, a 47nF capacitor will generate a 1s watchdog time-out period. The watchdog function can be disabled by connecting this pin to ground.

**RT (Pin 8):** Reset Time-Out Input. Place a capacitor between this pin and ground to adjust the reset time-out period. To determine the reset time-out period:

$$t_{RT} = 3.30 \cdot C_{RT}$$

with  $t_{RT}$  in µs and  $C_{RT}$  in pF. As an example, a 47nF capacitor will generate a 155ms reset time-out period.

# BLOCK DIAGRAM

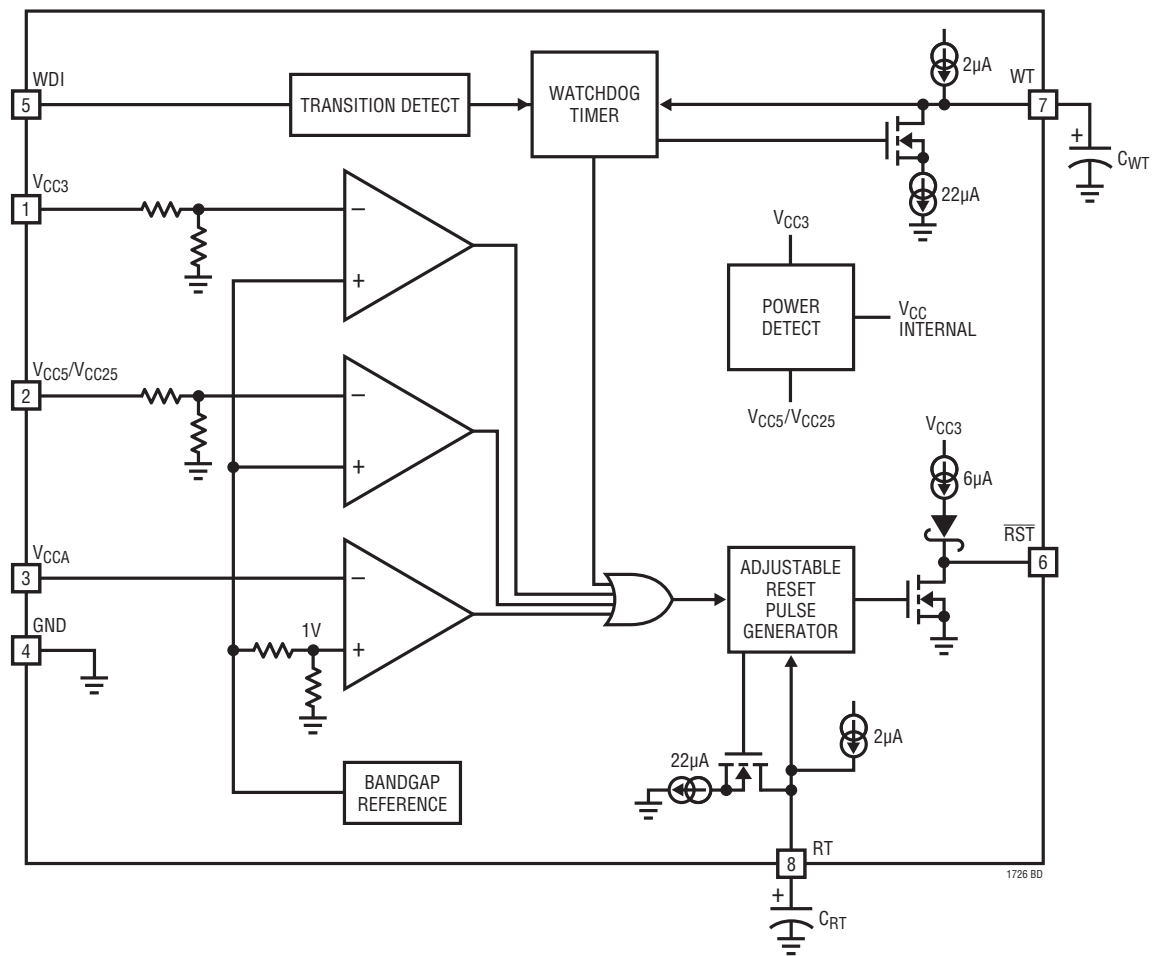

# TIMING DIAGRAM

VCC Monitor Timing

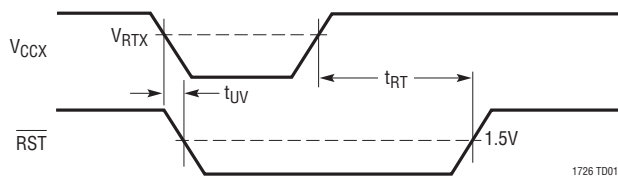

Watchdog Timing Diagram

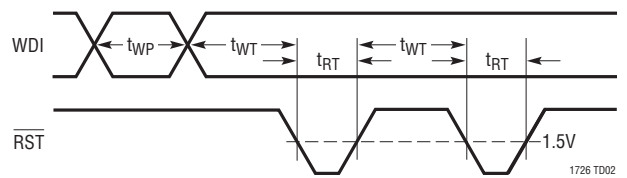

## APPLICATIONS INFORMATION

### Supply Monitoring

The LTC1726 is a low power, high accuracy triple supply monitor and watchdog timer. The watchdog and reset periods are both adjustable using external capacitors.

All three  $V_{CC}$  inputs must be above predetermined thresholds for reset not to be asserted. The LTC1726 will assert reset during power-up, power-down and brownout conditions on any one or all of the  $V_{CC}$  inputs.

Upon power-up, either the  $V_{CC5}/V_{CC25}$  or  $V_{CC3}$  pin can power the drive circuits for the  $\overline{RST}$  pin. This ensures that  $\overline{RST}$  will be low when either  $V_{CC5}/V_{CC25}$  or  $V_{CC3}$  reaches 1V. As long as any one of the  $V_{CC}$  inputs is below its predetermined threshold,  $\overline{RST}$  will stay a logic low. Once all of the  $V_{CC}$  inputs rise above their thresholds, the adjustable reset timer is started and  $\overline{RST}$  is released after the reset time-out period.

On power-down, once any of the  $V_{CC}$  inputs drops below its threshold,  $\overline{RST}$  is held at a logic low. A logic low of 0.3V is guaranteed until both  $V_{CC3}$  and  $V_{CC5}/V_{CC25}$  drop below 1V.

### 3V or 5V/2.5V Power Detect

Since the LTC1726 is a multisupply monitor, it will be required to assert reset as soon as there is power on any one of the monitor inputs. Therefore, the part derives its power from either the  $V_{CC3}$  or  $V_{CC5}/V_{CC25}$  input, whichever pin has the greatest potential. This ensures the part pulls the  $\overline{RST}$  pin low as soon as either input pin is  $\geq 1V$ . The adjustable input is excluded from being a potential supply pin because of its 1V nominal operating range.

### Override Functions (5V Versions Only)

The  $V_{CCA}$  pin, if unused, can be tied to either  $V_{CC3}$  or  $V_{CC5}$ . This is an obvious solution since the trip points for  $V_{CC3}$  and  $V_{CC5}$  will always be greater than the trip point for  $V_{CCA}$ .

The  $V_{CC5}$  input trip point is disabled if its voltage is equal to the voltage on  $V_{CC3} \pm 25mV$  and the voltage on  $V_{CC5}$  is less than 4.15V. In this manner the LTC1726-5 behaves as a 3.3V monitor and the 5V reset function is disabled.

The  $V_{CC5}$  trip point is re-enabled when the voltage on  $V_{CC5}$  is equal to the voltage on  $V_{CC3} \pm 25mV$  and the two inputs

are greater than approximately 4.15V. In this manner, the part can function as a 5V monitor with the 3.3V monitor disabled.

When monitoring either 3.3V or 5V with  $V_{CC3}$  strapped to  $V_{CC5}$ , (see Figure 1) the part determines which is the appropriate range. The part handles this situation as shown in Figure 2. Above 1V and below  $V_{RT3}$ ,  $\overline{RST}$  is held low. From  $V_{RT3}$  to approximately 4.15V, the part assumes 3.3V supply monitoring and  $\overline{RST}$  is deasserted. Above approximately 4.15V, the part operates as a 5V monitor. In most systems, the 5V supply will pass through the 3.1V to 4.15V region in  $<200ms$  during power-up, and the  $\overline{RST}$  output will behave as desired. Table 1 summarizes the state of  $\overline{RST}$  at various operating voltages with  $V_{CC3} = V_{CC5}$ .

**Table 1. Override Truth Table ( $V_{CC3} = V_{CC5}$ )**

INPUTS ( $V_{CC3} = V_{CC5} = V_{CC}$ )	$\overline{RST}$
$0V \leq V_{CC} \leq 1V$	—
$1V \leq V_{CC} \leq V_{RT3}$	0
$V_{RT3} \leq V_{CC} \leq 4.15V$	1
$4.15V \leq V_{CC} \leq V_{RT5}$	0
$V_{RT5} \leq V_{CC}$	1

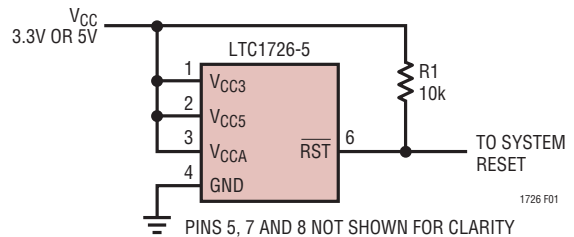

**Figure 1. Single Supply Monitor with Others Disabled**

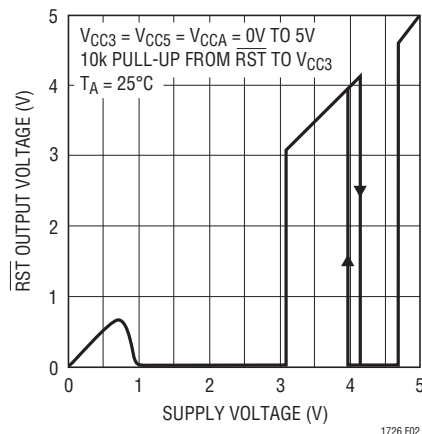
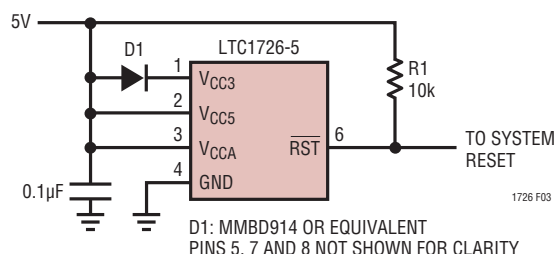

**Figure 2.  $\overline{RST}$  Voltage vs Supply Voltage**



## APPLICATIONS INFORMATION

Figure 3 contains a simple circuit for 5V systems that can't risk the  $\overline{\text{RST}}$  output going high in the 3.1V to 4.15V range (possibly due to very slow rise time on the 5V supply). Diode D1 powers the LTC1726-5 while dropping  $\approx 0.6\text{V}$  from the  $V_{\text{CC5}}$  pin to the  $V_{\text{CC3}}$  pin. This prevents the part's internal override circuit from being activated. Without the override circuit active, the  $\overline{\text{RST}}$  pin stays low until  $V_{\text{CC5}}$  reaches  $V_{\text{RT5}} \approx 4.675\text{V}$ . (See Figure 4.)



**Figure 3. LTC1726-5 Monitoring a Single 5V Supply. D1 Used to Avoid  $\overline{\text{RST}}$  High Near 3.1V to 4V (See Figure 2).**

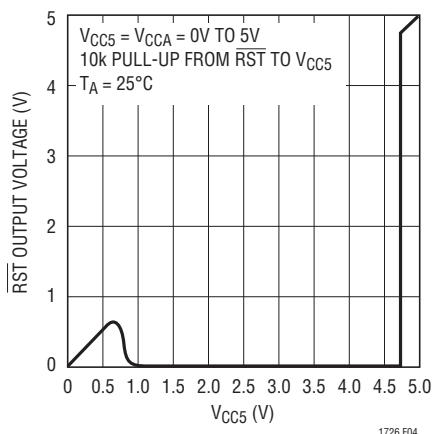

**Figure 4.  $\overline{\text{RST}}$  Output Voltage Characteristics of the Circuit in Figure 3**

### LTC1726-2.5 Override Functions

The  $V_{\text{CCA}}$  pin, if unused, can be tied to either  $V_{\text{CC3}}$  or  $V_{\text{CC25}}$ . This is an obvious solution since the trip points for  $V_{\text{CC3}}$  and  $V_{\text{CC25}}$  will always be greater than the trip point for  $V_{\text{CCA}}$ . Likewise, the  $V_{\text{CC25}}$ , if unused, can be tied to  $V_{\text{CC3}}$ .  $V_{\text{CC3}}$  must always be used. Tying  $V_{\text{CC3}}$  to  $V_{\text{CC25}}$  and operating off of a 2.5V supply will result in the continuous assertion of  $\overline{\text{RST}}$ .

### Watchdog Timer

The watchdog circuit monitors a  $\mu\text{P}$ 's activity. The  $\mu\text{P}$  is required to change the logic state of the WDI pin on a periodic basis in order to clear the watchdog timer and prevent the LTC1726 from issuing a reset.

During power-up, the watchdog timer remains cleared while reset is asserted. As soon as the reset timer times out, the watchdog timer is started. The watchdog timer will continue to run until a transition is detected on the WDI input or until the watchdog timer times out. Once the watchdog timer times out, the internal circuitry asserts the reset and starts the reset timer. When the reset timer times out and reset is deasserted, the watchdog timer is again started. If no WDI transition is received within the watchdog time-out period, the reset will be reasserted at the end of the watchdog time-out period. If a transition is received on the WDI input during the watchdog time-out period, the watchdog timer will be restarted and reset will remain deasserted.

### Selecting the Reset and Watchdog Time-Out Capacitors

The reset time-out period is adjustable in order to accommodate a variety of  $\mu\text{P}$  applications. The reset time-out period,  $t_{\text{RT}}$ , is adjusted by connecting a capacitor,  $C_{\text{RT}}$ , between the RT pin and ground. The value of this capacitor is determined as follows:

$$C_{\text{RT}} = t_{\text{RT}}/3.30$$

with  $C_{\text{RT}}$  in pF and  $t_{\text{RT}}$  in  $\mu\text{s}$  (i.e.,  $1500\text{pF} \Rightarrow 4.95\text{ms}$ ). The capacitor should be a low leakage type. A ceramic capacitor is recommended.

The watchdog period is also adjustable so that the watchdog time-out period can be optimized for software execution. The watchdog time-out period,  $t_{\text{WT}}$ , is adjusted by connecting a capacitor,  $C_{\text{WT}}$ , between the WT pin and ground. Once the optimum watchdog time-out period ( $t_{\text{WT}}$ ) is determined, the value of the capacitor is calculated as follows:

$$C_{\text{WT}} = t_{\text{WT}}/21.8$$

with  $C_{\text{WT}}$  in pF and  $t_{\text{WT}}$  in  $\mu\text{s}$  (i.e.,  $1500\text{pF} \Rightarrow 32.7\text{ms}$ ). The capacitor should be a low leakage type. A ceramic capacitor is recommended.

## TYPICAL APPLICATIONS

### Disabling the Watchdog Timer

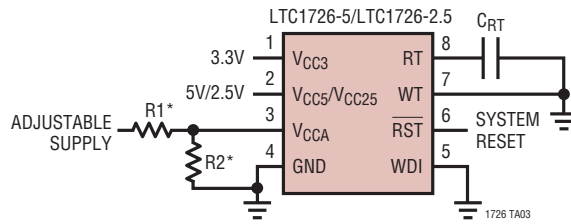

\*TO PRESERVE THRESHOLD ACCURACY, SET PARALLEL COMBINATION OF R1 AND R2  $\leq 66.5k$

THE WATCHDOG TIMER CAN BE DISABLED BY CONNECTING THE WDI AND WT PINS TO GROUND. THE PART WILL ACT STRICTLY AS A TRIPLE SUPPLY MONITOR WITH AN ADJUSTABLE RESET TIME-OUT PERIOD

### Triple Supply Monitor (3.3V, 5V and Adjustable)

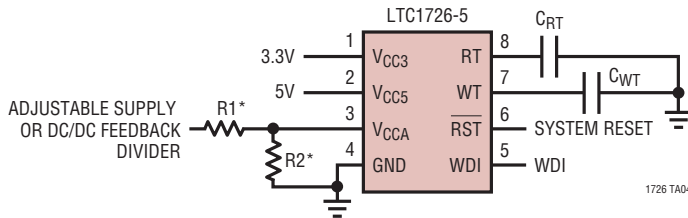

\*TO PRESERVE THRESHOLD ACCURACY, SET PARALLEL COMBINATION OF R1 AND R2  $\leq 66.5k$

### Dual Supply Monitor (3.3V and 5V, Defeat VCCA Input)

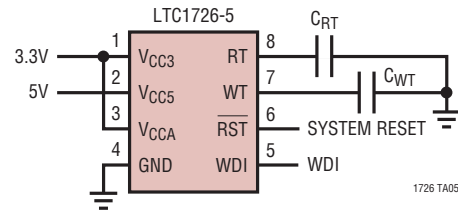

### Dual Supply Monitor (3.3V or 5V Plus Adjustable)

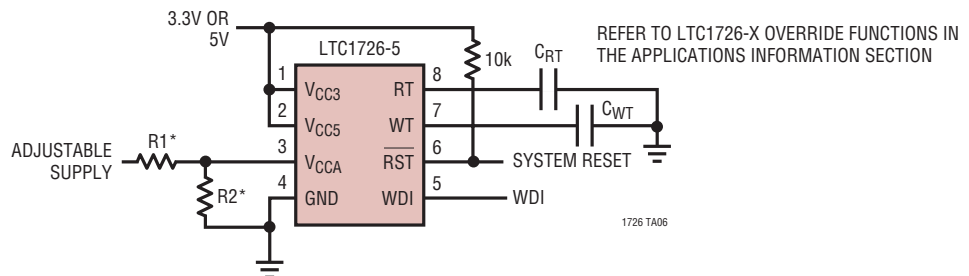

\*TO PRESERVE THRESHOLD ACCURACY, SET PARALLEL COMBINATION OF R1 AND R2  $\leq 66.5k$

### Dual Supply Monitor (3.3V Plus Adjustable)

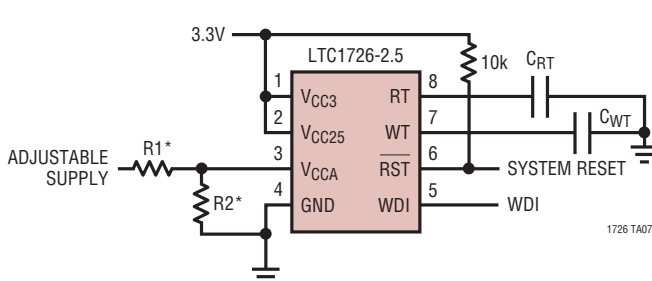

\*TO PRESERVE THRESHOLD ACCURACY, SET PARALLEL COMBINATION OF R1 AND R2  $\leq 66.5k$

### Using VCCA Tied to DC/DC Feedback Divider

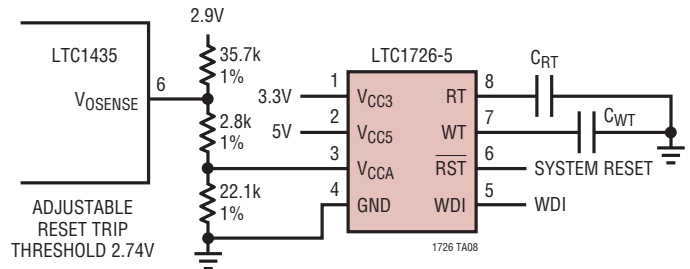

## PACKAGE DESCRIPTION

Please refer to <http://www.linear.com/designtools/packaging/> for the most recent package drawings.

### MS8 Package 8-Lead Plastic MSOP

(Reference LTC DWG # 05-08-1660 Rev F)

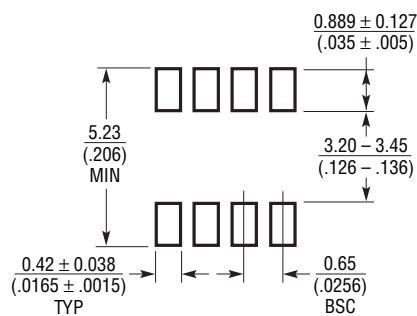

RECOMMENDED SOLDER PAD LAYOUT

NOTE:

1. DIMENSIONS IN MILLIMETER/(INCH)
2. DRAWING NOT TO SCALE
3. DIMENSION DOES NOT INCLUDE MOLD FLASH, PROTRUSIONS OR GATE BURRS.  
MOLD FLASH, PROTRUSIONS OR GATE BURRS SHALL NOT EXCEED 0.152mm (.006") PER SIDE
4. DIMENSION DOES NOT INCLUDE INTERLEAD FLASH OR PROTRUSIONS.  
INTERLEAD FLASH OR PROTRUSIONS SHALL NOT EXCEED 0.152mm (.006") PER SIDE
5. LEAD COPLANARITY (BOTTOM OF LEADS AFTER FORMING) SHALL BE 0.102mm (.004") MAX

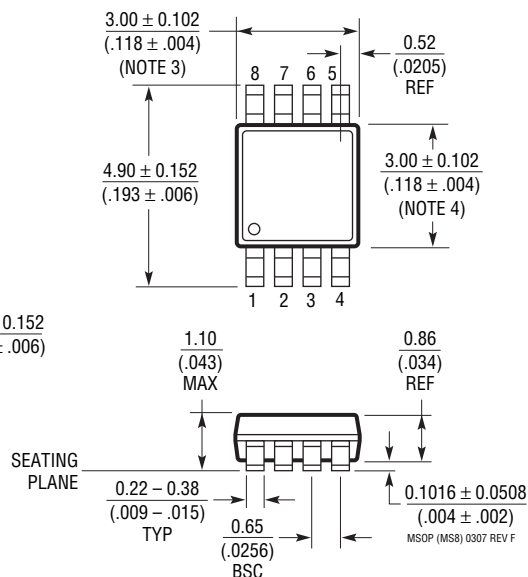
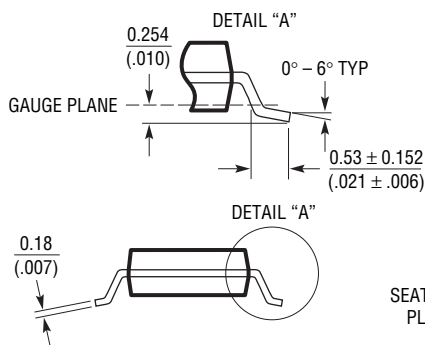

# PACKAGE DESCRIPTION

Please refer to <http://www.linear.com/designtools/packaging/> for the most recent package drawings.

## S8 Package 8-Lead Plastic Small Outline (Narrow .150 Inch) (Reference LTC DWG # 05-08-1610 Rev G)

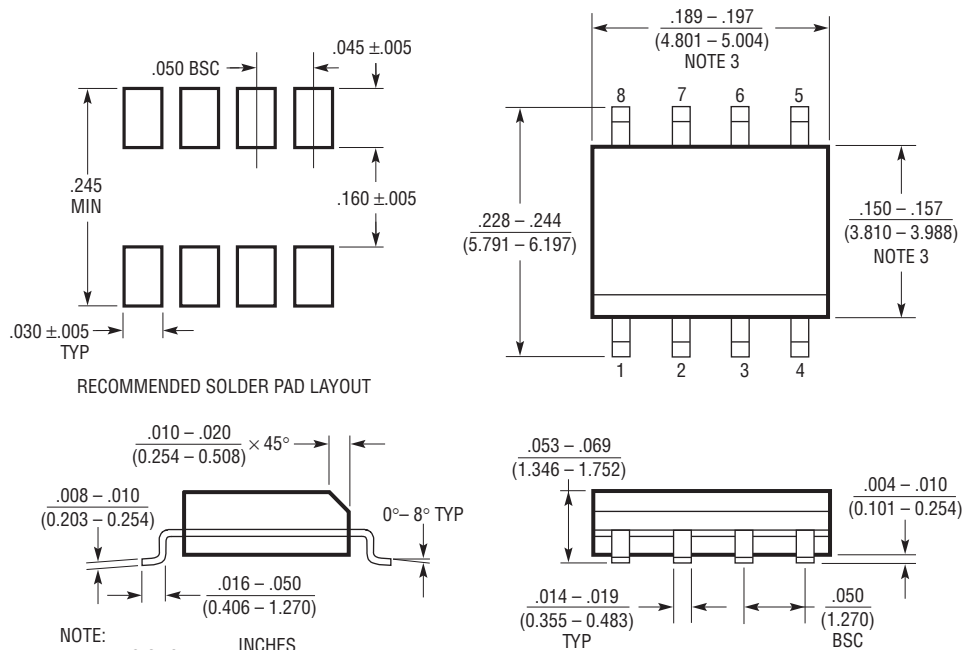

- NOTE:
1. DIMENSIONS IN  $\frac{\text{INCHES}}{\text{MILLIMETERS}}$
  2. DRAWING NOT TO SCALE
  3. THESE DIMENSIONS DO NOT INCLUDE MOLD FLASH OR PROTRUSIONS. MOLD FLASH OR PROTRUSIONS SHALL NOT EXCEED  $.006''$  ( $0.15\text{mm}$ )
  4. PIN 1 CAN BE BEVEL EDGE OR A DIMPLE

S08 REV G 0212

**REVISION HISTORY** (Revision history begins at Rev C)

REV	DATE	DESCRIPTION	PAGE NUMBER
C	10/10	Added H-grade to Absolute Maximum Ratings and Electrical Characteristics sections.	2, 3
D	4/13	Clarified $\Delta t_{RT}$ conditions.	3

## TYPICAL APPLICATION

## Triple Supply Monitor with Watchdog Timer and Manual Reset Button

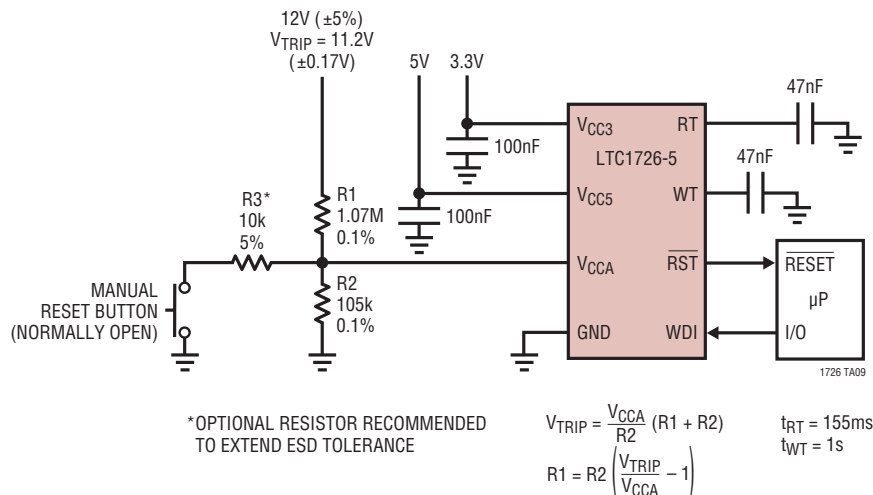

## RELATED PARTS

PART NUMBER	DESCRIPTION	COMMENTS
<a href="#">LTC690</a>	5V Supply Monitor, Watchdog Timer and Battery Backup	4.65V Threshold
<a href="#">LTC694-3.3</a>	3.3V Supply Monitor, Watchdog Timer and Battery Backup	2.9V Threshold
<a href="#">LTC699</a>	5V Supply Monitor and Watchdog Timer	4.65V Threshold
<a href="#">LTC1232</a>	5V Supply Monitor, Watchdog Timer and Push-Button Reset	4.37V/4.62V Threshold
<a href="#">LTC1326</a>	Micropower Precision Triple Supply Monitor for 5V, 3.3V and ADJ	4.725V, 3.118V, 1V Thresholds ( $\pm 0.75\%$ ) 5V, 3.3V, ADJ
<a href="#">LTC1326-2.5</a>	Micropower Precision Triple Supply Monitor for 2.5V, 3.3V and ADJ	2.363V, 3.118V, 1V Thresholds ( $\pm 0.75\%$ ) 2.5V, 3.3V, ADJ
<a href="#">LTC1536</a>	Precision Triple Supply Monitor for PCI Applications	Meets PCI $t_{FAIL}$ Timing Specifications
<a href="#">LTC1727-5</a>	Micropower Triple Supply Monitor with Individual Outputs	4.675V, 3.086V, 1V Thresholds ( $\pm 1.5\%$ ) 5V, 3.3V, ADJ
<a href="#">LTC1727-2.5</a>	Micropower Triple Supply Monitor with Individual Outputs	2.338V, 3.086V, 1V Thresholds ( $\pm 1.5\%$ ) 2.5V, 3.3V, ADJ
<a href="#">LTC1728-5</a>	Micropower Triple Supply Monitor in 5-Pin SOT-23 Package	4.675V, 3.086V, 1V Thresholds ( $\pm 1.5\%$ ) 5V, 3.3V, ADJ
<a href="#">LTC1728-2.5</a>	Micropower Triple Supply Monitor in 5-Pin SOT-23 Package	2.338V, 3.086V, 1V Thresholds ( $\pm 1.5\%$ ) 2.5V, 3.3V, ADJ
<a href="#">LTC1728-1.8</a>	Micropower Triple Supply Monitor in 5-Pin SOT-23 Package	2.805V, 1.683V, 1V Thresholds ( $\pm 1.5\%$ ) 3V, 1.8V, ADJ
<a href="#">LTC1985-1.8</a>	Micropower Triple Supply Monitor for 3V, 1.8V and ADJ	Push-Pull RESE $\overline{T}$ Output, SOT-23
<a href="#">LTC2900</a>	Quad Supply Monitor	Adjustable Reset Timer
<a href="#">LTC2901</a>	Quad Supply Monitor with Watchdog Timer	Adjustable Watchdog and Reset Timers
<a href="#">LTC2902</a>	Quad Supply Monitor with Selectable Supply Tolerance	Reset Disable for Margining Applications
<a href="#">LTC2903</a>	Precision Quad Supply Monitor in SOT-23	Fixed and Adjustable Threshold Combinations
<a href="#">LTC2908</a>	Precision Six Supply Monitor	8-Lead ThinSOT™ and 3mm × 2mm DFN Packages
<a href="#">LTC2910</a>	Octal Positive/Negative Voltage Monitor	8 Low Voltage Adjustable Inputs (0.5V)



Компания «ЭлектроПласт» предлагает заключение долгосрочных отношений при поставках импортных электронных компонентов на взаимовыгодных условиях!

Наши преимущества:

- Оперативные поставки широкого спектра электронных компонентов отечественного и импортного производства напрямую от производителей и с крупнейших мировых складов;
- Поставка более 17-ти миллионов наименований электронных компонентов;
- Поставка сложных, дефицитных, либо снятых с производства позиций;
- Оперативные сроки поставки под заказ (от 5 рабочих дней);
- Экспресс доставка в любую точку России;
- Техническая поддержка проекта, помощь в подборе аналогов, поставка прототипов;
- Система менеджмента качества сертифицирована по Международному стандарту ISO 9001;
- Лицензия ФСБ на осуществление работ с использованием сведений, составляющих государственную тайну;
- Поставка специализированных компонентов (Xilinx, Altera, Analog Devices, Intersil, Interpoint, Microsemi, Aeroflex, Peregrine, Syfer, Eurofarad, Texas Instrument, Miteq, Cobham, E2V, MA-COM, Hittite, Mini-Circuits, General Dynamics и др.);

Помимо этого, одним из направлений компании «ЭлектроПласт» является направление «Источники питания». Мы предлагаем Вам помощь Конструкторского отдела:

- Подбор оптимального решения, техническое обоснование при выборе компонента;
- Подбор аналогов;
- Консультации по применению компонента;
- Поставка образцов и прототипов;
- Техническая поддержка проекта;
- Защита от снятия компонента с производства.



#### Как с нами связаться

**Телефон:** 8 (812) 309 58 32 (многоканальный)

**Факс:** 8 (812) 320-02-42

**Электронная почта:** [org@eplast1.ru](mailto:org@eplast1.ru)

**Адрес:** 198099, г. Санкт-Петербург, ул. Калинина, дом 2, корпус 4, литера А.