

Product: [RSWPA 4-RKWPA 4-805](#) 



Mini Power Double-Ended Cordset: 7/8" male angled to 7/8" female angled, 4-pin(3+PE), black body, 600 V, 15 A; TPE black cable, 14 AWG

Product Description

Mini Power Double-Ended Cordset: 7/8" male angled to 7/8" female angled, 4-pin(3+PE), black body, 600 V, 15 A; TPE black cable, 14 AWG

Technical Drawing

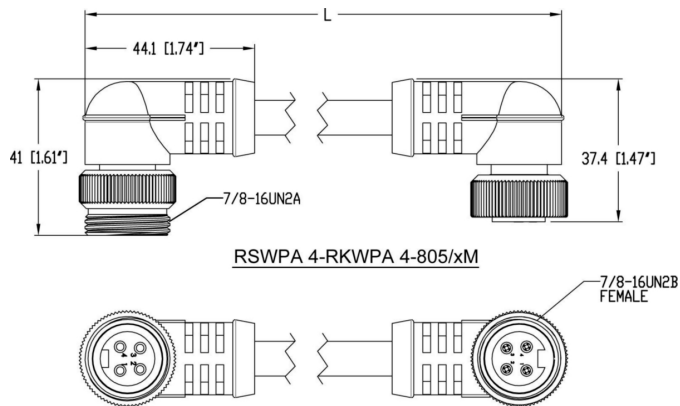

Technical Specifications

Product Description

Product Family:	Power Connector
Brand:	Lumberg Automation
Connector Type:	Cordset, double ended
Shielding:	Unshielded
Rated Voltage (UL):	600 V
Rated Current (UL)*:	15 A

Technical Data Side 1

Product Sub Family:	7/8"
Type of Contact / Gender:	male
Connector Design:	angled
Attachment Type:	Coupling Nut
Number of Pins:	4(3+PE)
Ambient Temperature (Operation)*:	-30 °C to +90 °C
Protection Degree / IP Rating**:	IP 67, IP 68
Contact Base Material:	CuSn
Contact Plating:	Ni/Au
Contact Bearer Material:	PVC
Contact Bearer Color:	black
Molded Body Material:	PVC
Molded Body Color:	black

Attachment Material:	CuZn
----------------------	------

Cable Data

Cable Number:	805
Conductor Size:	14 AWG
Number of Wires:	4
Cable Jacket Material:	TPE
Cable Jacket Color:	black
Cable Diameter D:	ø 0.390"
Wire Insulation Material:	PVC/NYLON
Ambient Temperature (Fixed Installation):	-30 °C to +90 °
Flammability Class (Cable Jacket):	FT-4

Technical Data Side 2

Product Sub Family, Side 2:	7/8"
Type of Contact / Gender, Side 2:	female
Connector Design, Side 2:	angled
Attachment Type, Side 2:	Coupling Screw
Number of Pins, Side 2:	4(3+PE)
Ambient Temperature (Operation), Side 2*:	-30 °C to +90 °C
Protection Degree / IP Rating, Side 2**:	IP 67, IP 68
Contact Base Material, Side 2:	CuSn
Contact Plating, Side 2:	Ni/Au
Contact Bearer Material, Side 2:	PVC
Contact Bearer Color, Side 2:	black
Molded Body Material, Side 2:	PVC
Molded Body Color, Side 2:	black
Attachment Material, Side 2:	CuZn

Approvals

UL-File:	E482233
UL:	TC-ER

Safety & Environmental Compliance

RoHS Compliant:	Yes
-----------------	-----

Resistances

Oil Resistance:	Oil Res I/II
UV Resistance:	Sunlight Res

Notes

Protection Degree / IP Rating Note:	** only if mounted and locked in combination with Hirschmann / Lumberg Automation connector.
-------------------------------------	--

Variants

Item #	Item Description	Cable Length
511000257	RSWPA 4-RKWPA 4-805/0.5M	0.5 m
511000258	RSWPA 4-RKWPA 4-805/1M	1 m
511000259	RSWPA 4-RKWPA 4-805/1.5M	1.5 m
511000260	RSWPA 4-RKWPA 4-805/2M	2 m
511000261	RSWPA 4-RKWPA 4-805/2.5M	2.5 m
511000262	RSWPA 4-RKWPA 4-805/3M	3 m
511000263	RSWPA 4-RKWPA 4-805/4M	4 m
511000264	RSWPA 4-RKWPA 4-805/5M	5 m
511000265	RSWPA 4-RKWPA 4-805/6M	6 m
511000266	RSWPA 4-RKWPA 4-805/8M	8 m
511000267	RSWPA 4-RKWPA 4-805/10M	10 m
511000268	RSWPA 4-RKWPA 4-805/12M	12 m
511000269	RSWPA 4-RKWPA 4-805/14M	14 m
511000270	RSWPA 4-RKWPA 4-805/15M	15 m

511000271	RSWPA 4-RKWPA 4-805/18M	18 m
511000272	RSWPA 4-RKWPA 4-805/20M	20 m
511000273	RSWPA 4-RKWPA 4-805/22M	22 m
511000274	RSWPA 4-RKWPA 4-805/25M	25 m
511000275	RSWPA 4-RKWPA 4-805/30M	30 m
511000276	RSWPA 4-RKWPA 4-805/35M	35 m
511000277	RSWPA 4-RKWPA 4-805/40M	40 m
511000278	RSWPA 4-RKWPA 4-805/45M	45 m
511000279	RSWPA 4-RKWPA 4-805/50M	50 m

© 2020 Belden, Inc

All Rights Reserved.

Although Belden makes every reasonable effort to ensure their accuracy at the time of this publication, information and specifications described here in are subject to error or omission and to change without notice, and the listing of such information and specifications does not ensure product availability.

Belden provides the information and specifications herein on an "ASIS" basis, with no representations or warranties, whether express, statutory or implied. In no event will Belden be liable for any damages (including consequential, indirect, incidental, special, punitive, or exemplary damages) whatsoever, even if Belden has been advised of the possibility of such damages, whether in an action under contract, negligence or any other theory, arising out of or in connection with the use, or inability to use, the information or specifications described herein.

All sales of Belden products are subject to Belden's standard terms and conditions of sale.

Belden believes this product to be in compliance with all applicable environmental programs as listed in the data sheet. The information provided is correct to the best of Belden's knowledge, information and belief at the date of its publication. This information is designed only as a general guide for the safe handling, storage, and any other operation of the product itself or the one that it becomes a part of. The Product Disclosure is not to be considered a warranty or quality specification. Regulatory information is for guidance purposes only. Product users are responsible for determining the applicability of legislation and regulations based on their individual usage of the product.



Компания «ЭлектроПласт» предлагает заключение долгосрочных отношений при поставках импортных электронных компонентов на взаимовыгодных условиях!

Наши преимущества:

- Оперативные поставки широкого спектра электронных компонентов отечественного и импортного производства напрямую от производителей и с крупнейших мировых складов;
- Поставка более 17-ти миллионов наименований электронных компонентов;
- Поставка сложных, дефицитных, либо снятых с производства позиций;
- Оперативные сроки поставки под заказ (от 5 рабочих дней);
- Экспресс доставка в любую точку России;
- Техническая поддержка проекта, помощь в подборе аналогов, поставка прототипов;
- Система менеджмента качества сертифицирована по Международному стандарту ISO 9001;
- Лицензия ФСБ на осуществление работ с использованием сведений, составляющих государственную тайну;
- Поставка специализированных компонентов (Xilinx, Altera, Analog Devices, Intersil, Interpoint, Microsemi, Aeroflex, Peregrine, Syfer, Eurofarad, Texas Instrument, Miteq, Cobham, E2V, MA-COM, Hittite, Mini-Circuits, General Dynamics и др.);

Помимо этого, одним из направлений компании «ЭлектроПласт» является направление «Источники питания». Мы предлагаем Вам помощь Конструкторского отдела:

- Подбор оптимального решения, техническое обоснование при выборе компонента;
- Подбор аналогов;
- Консультации по применению компонента;
- Поставка образцов и прототипов;
- Техническая поддержка проекта;
- Защита от снятия компонента с производства.



Как с нами связаться

Телефон: 8 (812) 309 58 32 (многоканальный)

Факс: 8 (812) 320-02-42

Электронная почта: org@eplast1.ru

Адрес: 198099, г. Санкт-Петербург, ул. Калинина, дом 2, корпус 4, литера А.