

DLLR - High Accuracy Pressure Sensors Series



Table of Contents

Features & Applications	2
Standard Pressure Ranges	2
Pressure Sensor Maximum Ratings	2
Environmental Specifications	2
Electrical Block Diagram	2
Performance Characteristics	3
I²C / SPI Electrical Parameters	4
Device Ordering Options	5
Operation Overview	6-7
Digital Interface Command Formats	8
Digital Interface Data Format	9
I²C Interface	9-10
SPI Interface	11
Interface Timing Diagrams	12
Extended Compensation Instructions	13-15
How to Order Guide	16
Dimensional Package Drawings	
SIP	17-18
DIP	19-20
SMT	21
Suggested Pad Layout	22

Introduction

The DLLR Series Mini Digital Output Sensor is based on All Sensors' CoBeam²™ Technology. This reduces package stress susceptibility, resulting in improved overall long term stability and vastly improves the position sensitivity.

The digital interface eases integration of the sensors into a wide range of process control and measurement systems, allowing direct connection to serial communications channels. For battery-powered systems, the sensors can enter very low-power mode between readings to minimize load on the power supply.

These calibrated and compensated sensors provide accurate, stable output over a wide temperature range. This series is intended for use with non-corrosive, non-ionic working fluids such as air, dry gases.

<https://www.allsensors.com/products/dllr-series>



DLLR SERIES HIGH ACCURACY PRESSURE SENSORS

Features

- 10 & 30 inH2O Pressure Ranges
- 1.68V to 3.6V Supply Voltage Range
- I2C or SPI Interface (Automatically Selected)
- Better Than 0.10% Accuracy
- High Resolution 16/17/18 Bit Output

Applications

- Medical Breathing
- Environmental Controls
- HVAC
- Industrial Controls
- Portable/Hand-Held Equipment

Standard Pressure Ranges

Device	Operating Range ^A		Proof Pressure		Burst Pressure		Nominal Span
	inH2O	Pa	inH2O	kPa	inH2O	kPa	Counts
DLLR-L10D	± 10	2488.4	100	25	300	75	±0.4 * 2 ²⁴
DLLR-L10G	0 to 10	2488.4	100	25	300	75	0.8 * 2 ²⁴
DLLR-L30D	± 30	7465.2	100	25	300	75	±0.4 * 2 ²⁴
DLLR-L30G	0 to 30	7465.2	100	25	300	75	0.8 * 2 ²⁴

Note A: Operating range in Pa is expressed as an approximate value.

Pressure Sensor Maximum Ratings	Electrical Block Diagram
<p>Supply Voltage (Vs) 3.63 Vdc</p> <p>Common Mode Pressure 10 psig</p> <p>Lead Temperature (soldering 2-4 sec.) 270 °C</p>	<p>For SIP Packages</p> 
<p>Environmental Specifications</p> <p>Temperature Ranges</p> <p>Compensated: Commercial 0°C to 70°C</p> <p>Operating -25°C to 85 °C</p> <p>Storage -40°C to 125 °C</p> <p>Humidity Limits (non condensing) 0 to 95% RH</p>	<p>For DIP and J-Lead Packages</p> 



Performance Characteristics for DLLR Series High Accuracy Low Pressure Sensors

All parameters are measured at $\pm 3.3V \pm 5\%$ excitation and 25C unless otherwise specified^(Note 9). Pressure measurements are with positive pressure applied to PORT B.

Parameter	Minimum	Typical	Maximum	Units	Specification Notes
Output Span					
LxxD	-	$\pm 0.4 * 2^{24}$	-	Dec Count	1
LxxG	-	$0.8 * 2^{24}$	-	Dec Count	1
Offset Output @ Zero Diff. Pressure (OS_{dig})					
LxxD	-	$0.5 * 2^{24}$	-	Dec Count	-
LxxG	-	$0.1 * 2^{24}$	-	Dec Count	-
Error Summary					
L10D					
Total Error Band	-	± 0.10	± 0.25	%FSS	2, 6
Span Temperature Shift	-	± 6	-	ppmFSS/C	4, 6
Offset Temperature Shift	-	± 9	-	ppmFSS/C	4, 6
Accuracy	-	± 0.03	± 0.10	%FSS	3, 6
L10G					
Total Error Band	-	± 0.06	± 0.20	%FSS	2, 6
Span Temperature Shift	-	± 7	-	ppmFSS/C	4, 6
Offset Temperature Shift	-	± 3	-	ppmFSS/C	4, 6
Accuracy	-	± 0.03	± 0.10	%FSS	3, 6
L30D					
Total Error Band	-	± 0.10	± 0.35	%FSS	2, 6
Span Temperature Shift	-	± 10	-	ppmFSS/C	4, 6
Offset Temperature Shift	-	± 4	-	ppmFSS/C	4, 6
Accuracy	-	± 0.03	± 0.10	%FSS	3, 6
L30G					
Total Error Band	-	± 0.05	± 0.15	%FSS	2, 6
Span Temperature Shift	-	± 6	-	ppmFSS/C	4, 6
Offset Temperature Shift	-	± 3	-	ppmFSS/C	4, 6
Accuracy	-	± 0.03	± 0.10	%FSS	3, 6
Offset Position Sensitivity ($\pm 1g$)	-	± 0.10	-	%FSS	-
Offset Long Term Drift (one year)	-	± 0.25	-	%FSS	-
Pressure Digital Resolution - No Missing Codes					
16-bit Option	15.7	-	-	bit	-
17-bit Option	16.7	-	-	bit	-
18-bit Option	17.7	-	-	bit	-
Temperature Output					
Resolution	-	16	-	bit	-
Overall Accuracy	-	2	-	$^{\circ}C$	-
Supply Current Requirement 5, 7, 8					
During Active State (ICC_{Active})	-	2	2.6	mA	-
During Idle State (ICC_{Idle})	-	100	250	nA	-
Power On Delay	-	-	2.5	ms	5
Memory Read Access Time	30	-	-	ms	10
Data Update Time (t_{DU})	(see table below)				5, 7

Calibrated Resolution	Measurement Command										Units
	Single		Average2		Average4		Average8		Average16		
	Typ	Max	Typ	Max	Typ	Max	Typ	Max	Typ	Max	
16 bit option	2.80	3.1	5.40	6.0	10.60	11.7	21.00	23.2	41.80	46.0	ms
17 bit option	3.20	3.6	6.20	6.9	12.20	13.5	24.20	26.7	48.20	53.1	ms
18 bit option	3.70	4.1	7.20	8.0	14.20	15.7	28.20	31.1	56.20	61.9	ms

I2C / SPI Electrical Parameters for DLLR

Parameter	Symbol	Min	Typ	Max	Units	Notes
Input High Level	-	80.0	-	100	% of Vs	5
Input Low Level	-	0	-	20.0	% of Vs	5
Output Low Level	-	-	-	10.0	% of Vs	5
I2C Pull-up Resistor	-	1000	-	-	Ω	5
I2C Load Capacitance on SDA, @ 400 kHz	C _{SDA}	-	-	200	pF	5
I2C Input Capacitance (each pin)	C _{I2C_IN}	-	-	10.0	pF	5

Pressure Output Transfer Function

$$Pressure(inH_2O) = 1.25 \times \left(\frac{P_{out_{dig}} - OS_{dig}}{2^{24}} \right) \times FSS(inH_2O)$$

Where:

$P_{out_{dig}}$ Is the sensor 24-bit digital output, following corrections applied by extended compensation.

OS_{dig} Is the specified digital offset

For Gage Operating Range sensors: $0.1 * 2^{24}$

For Differential Operating Range sensors: $0.5 * 2^{24}$

$FSS(inH_2O)$ The sensor Full Scale Span in inches H₂O

For Gage Operating Range sensors: Full Scale Pressure

For Differential Operating Range sensors: 2 x Full Scale Pressure

Temperature Output Transfer Function

$$Temperature (^{\circ}C) = \left(\frac{T_{out_{dig}} * 125}{2^{24}} \right) - 40$$

Where:

$T_{out_{dig}}$ The sensor 24-bit digital temperature output.
(Note that only the upper 16 bits are significant)

Specification Notes

NOTE 1: THE SPAN IS THE ALGEBRAIC DIFFERENCE BETWEEN FULL SCALE DECIMAL COUNTS AND THE OFFSET DECIMAL COUNTS. THE FULL SCALE PRESSURE IS THE MAXIMUM POSITIVE CALIBRATED PRESSURE.

NOTE 2: TOTAL ERROR BAND CONSISTS OF OFFSET AND SPAN TEMPERATURE AND CALIBRATION ERRORS, LINEARITY AND PRESSURE HYSTERESIS ERRORS, OFFSET WARM-UP SHIFT, OFFSET POSITION SENSITIVITY AND LONG TERM OFFSET DRIFT ERRORS.

NOTE 3: ACCURACY INCLUDES PRESSURE HYSTERESIS, REPEATABILITY AND BEST-FIT STRAIGHT LINE LINEARITY, EVALUATED AT 25C.

NOTE 4: PARTS PER MILLION OF FULL-SCALE SPAN PER DEGREE C.

NOTE 5: PARAMETER IS CHARACTERIZED AND NOT 100% TESTED.

NOTE 6: EVALUATED FOLLOWING CORRECTIONS DESCRIBED IN EXTENDED COMPENSATION SECTION.

NOTE 7: DATA UPDATE TIME IS EXCLUSIVE OF COMMUNICATIONS, FROM COMMAND RECEIVED TO END OF BUSY STATUS. THIS CAN BE OBSERVED AS EOC PIN LOW- STATE DURATION.

NOTE 8: AVERAGE CURRENT CAN BE ESTIMATED AS : $ICC_{idle} + (t_{DU} / \text{READING INTERVAL}) * ICC_{ACTIVE}$. REFER TO FIGURE 2 FOR ACTIVE AND IDLE CONDITIONS OF THE SENSOR (THE ACTIVE STATE IS WHILE EOC PIN IS LOW).

NOTE 9: THE SENSOR IS CALIBRATED WITH A 3.3V SUPPLY HOWEVER, AN INTERNAL REGULATOR ALLOWS A SUPPLY VOLTAGE OF 1.68V TO 3.6V TO BE USED WITHOUT AFFECTING THE OVERALL SPECIFICATIONS. THIS ALLOWS DIRECT OPERATION FROM A BATTERY SUPPLY.

NOTE 10: DELAY BETWEEN END OF MEMORY READ REQUEST COMMUNICATION AND START OF MEMORY DATA READ COMMUNICATION.



Device Ordering Options

Output Resolution

Calibrated output resolution can be ordered to be 16, 17, or 18 bits.

Higher resolution results in slower update times; see the Data Update Time in the Performance Characteristics table.

Operation Overview

The DLLR is a digital sensor with a signal path that includes a sensing element, a variable-bit analog to digital converter, a DSP and an IO block that supports either an I2C or SPI interface (see Figure 1 below). The sensor also includes an internal temperature reference and associated control logic to support the configured operating mode. Since there is a single ADC, there is also a multiplexer at the front end of the ADC that selects the signal source for the ADC.

Figure 1 - DLLR Block Diagram



The ADC performs conversions on the raw sensor signal (P), the temperature reference (T) and a zero reference (Z) during the ADC measurement cycle.

The DSP receives the converted pressure and temperature information and applies a multi-order transfer function to compensate the pressure output. This transfer function includes compensation for span, offset, temperature effects on span, temperature effects on offset and second order temperature effects on offset. There is also linearity compensation for gage devices and front to back linearity compensation for differential devices. This compensated output is further improved by applying additional external correction, as described later in the Extended Compensation instructions section.

Sensor Commands: Five Measurement commands are supported, returning values of either a single pressure / temperature reading or an average of 2, 4, 8, or 16 readings. Each of these commands wakes the sensor from Idle state into Active state, and starts a measurement cycle. For the Start-Average commands, this cycle is repeated the appropriate number of times, while the Start-Single command performs a single iteration. When the DSP has completed calculations and the new values have been made available to the I/O block, the sensor returns to Idle state. The sensor remains in this low-power state until another Measurement command is received.

After completion of the measurement, the result may then be read using the Data Read command. The ADC and DSP remain in Idle state, and the I/O block returns the 7 bytes of status and measurement data. See Figure 2, following. At any time, the host may request current device status with the Status Read command. See Table 1 for a summary of all commands.

For optimum sensor performance, All Sensors recommends that Measurement commands be issued at a fixed interval by the host system. Irregular request intervals may increase overall noise on the output. *Furthermore, if reading intervals are much slower than the Device Update Time, using the Averaging commands is suggested to reduce offset shift. This shift is constant with respect to time interval, and may be removed by the application. For longer fixed reading intervals, this shift may be removed by the factory on special request.*

I/O Interface Configuration: The sensor automatically selects SPI or I2C serial interface, based on the following protocol: If the /SS input is set low by the host (as occurs during a SPI command transaction), the I/O interface will remain configured for SPI communications until power is removed. Otherwise, once a valid device address and command have been received over the I2C interface, the I/O interface will remain configured for I2C until power is removed.

NOTE: The four-pin (SIP) packages only support the I2C interface.



Operation Overview

Figure 2 - DLLR Communication



Digital Interface Command Formats

When requesting the start of a measurement, the command length for I2C is 1 byte, for SPI it is 3 bytes.

When requesting sensor status over I2C, the host simply performs a 1-byte read transfer.

When requesting sensor status over SPI, the host **MUST** send the Status Read command byte while reading 1 byte.

When reading sensor data over I2C, the host simply performs a 7-byte read transfer.

When reading sensor data over SPI, the host **MUST** send the 7-byte Data Read command while reading the data.

SENDING UNDOCUMENTED COMMANDS TO SENSOR WILL CORRUPT CALIBRATION AND IS NOT COVERED BY WARRANTY.

Table 1 - DLLR Sensor Command Set

Measurement Commands				
Description	SPI (3 bytes)			I2C (1 byte)
Start-Single	0xAA	0x00	0x00	0xAA
Start-Average2	0xAC	0x00	0x00	0xAC
Start-Average4	0xAD	0x00	0x00	0xAD
Start-Average8	0xAE	0x00	0x00	0xAE
Start-Average16	0xAF	0x00	0x00	0xAF

Read Sensor Data	
I2C	Read of 7 bytes from device
SPI	Read of 7 bytes from device Host must send [0xF0], then 6 bytes of [0x00] on MOSI Sensor Returns 7 bytes on MISO

Read Sensor Status	
I2C	Read of 1 byte from device.
SPI	Read of 1 byte from device Host must send [0xF0] on MOSI Sensor Returns 1 byte on MISO

Digital Interface Command Formats

The Memory Read Command is used to retrieve the extended Compensation Coefficients from internal memory of the sensor. Values (A, B, C, and D) are 32-bit signed integers, stored in eight 16-bit registers at addresses 47 through 54. Values TC50H and TC50L are stored in high byte and low byte, respectively, of address 55, as signed 8-bit integers. Value E is an 8-bit signed integer, stored at High Byte of address 56.

Table 2 - Coefficient Memory Map

Address	47 (0x2F)	48 (0x30)	49 (0x31)	50 (0x32)	51 (0x33)	52 (0x34)	53 (0x35)	54 (0x36)	55 (0x37)	56 (0x38)
Coeff. Word	[AHW]	[ALW]	[BHW]	[BLW]	[CHW]	[CLW]	[DHW]	[DLW]	[TC50H] [TC50L]	[E]

Each Word is stored in form ([High Byte]:[Low Byte]).

To form the complete integers A, B, C, and D, assemble the words in order ([xHW] : [xLW]). For E, the 8-bit high byte represents the complete integer. For TC50H and TC50L, the high byte and low byte, respectively, represent the complete integers.

The sequence of commands to retrieve these values is in the form of a Memory Read Request (See Table 3) followed by a Memory Data Read (See Table 4). Note that the Memory Read Access Time delay must be observed between the request and the read operations.

Table 3 - Memory Read Request Command

Memory Commands: I2C Write or SPI MOSI:				
Description	SPI (3 bytes)			I2C (1 byte)
Read Request	<EEPROM Address> (Values 47 -56 only)	0x00	0x00	<EEPROM Address> (Values 47 -56 only)

It must be emphasized that these commands be used accurately and carefully. Errors in forming or transmitting these commands can result in degraded sensor operation.

Table 4 - Memory Data Read Operation

Read Memory Data	
I2C	Read of 3 bytes from device.
SPI	Read of 3 bytes from device. Host must send [0xF0], then 2 bytes of [0x00] on MOSI. Sensor returns 3 bytes on MISO.

Example : I2C Read of Coefficient B :

Write <0x31> , and read back: <Status> <BHW>.

Write <0x32>, and read back: <Status> <BLW>.

B = [BHW:BLW], assembling BHW and BLW into a signed 32-bit integer.

Example : SPI Read of Coefficient D :

Write <0x35><0x00><0x00> ,

Set output buffer to <0xF0><0x00><0x00>, then perform 3-byte transfer.

Input buffer will then contain: <Status> < DHW_(high byte)> < DHW_(low byte)>.

Write <0x36><0x00><0x00> ,

Set output buffer to <0xF0><0x00><0x00>, then perform 3-byte transfer.

Input buffer will then contain: <Status> < DLW_(high byte)> < DLW_(low byte)>.

D = [DHW:DLW], assembling DHW and DLW into a signed 32-bit integer.

Digital Interface Data Format

For either type of digital interface, the format of data returned from the sensor is the same. For measurement data, the first byte consists of the Status Byte followed by a 24-bit unsigned pressure value and a 24-bit unsigned temperature value. See the Pressure Output Transfer Function and Temperature Output Transfer Function definitions on page 3 for converting to pressure and temperature. Refer to 'Extended Compensation Instructions Section' for improving the accuracy of output pressure values.

For memory data output, the status byte is followed by the high byte, then low byte of the memory word.

Refer to Table 5 for the overall data format of the sensor. Table 6 shows the Status Byte definition. Note that a completed reading without error will return status 0x40.

Table 5 - Measurement Output Data Format

S[7:0]	P[23:16]	P[15:8]	P[7:0]	T[23:16]	T[15:8]	T[7:0]
Status Byte	Pressure Byte 3	Pressure Byte 1	Pressure Byte 0	Temperature Byte 3	Temperature Byte 1	Temperature Byte 0

Table 6 - Memory Data Output Format

S[7:0]	MEM [15:8]	MEM[7:0]
Status Byte	MEM High Byte	MEM Low Byte

Table 7- Status Byte Definition

Bit	Description
Bit 7 [MSB]	[Always = 0]
6	Power : [1 = Power On]
5	Busy: [1 = Processing Command, 0 = Ready]
4:3	Mode: [00 = Normal Operation]
2	Memory Error [1 = EEPROM Checksum Fail]
1	Sensor Configuration [always = 0]
Bit 0 [LSB]	ALU Error [1 = Error]

I2C Interface

I2C Command Sequence

The part enters Idle state after power-up, and waits for a command from the bus master. Any of the five Measurement commands may be sent, as shown in Table 1. Following receipt of one of these command bytes, the EOC pin is set to Low level, and the sensor Busy bit is set in the Status Byte. After completion of measurement and calculation in the Active state, compensated data is written to the output registers, the EOC pin is set high, and the processing core goes back to Idle state. The host processor can then perform the Data Read operation, which for I2C is simply a 7-byte Device Read.

If the EOC pin is not monitored, the host can poll the Status Byte by repeating the Status Read command, which for I2C is a one-byte Device Read. When the Busy bit in the Status byte is zero, this indicate that valid data is ready, and a full Data Read of all 7 bytes may be performed.

DO NOT SEND COMMANDS TO SENSOR OTHER THAN THOSE DEFINED IN TABLES 1, 3 & 4.

I2C Interface (Cont'd)

I2C Bus Communications Overview

The I2C interface uses a set of signal sequences for communication. The following is a description of the supported sequences and their associated mnemonics. Refer to Figure 3 for the associated usage of the following signal sequences.

Bus not Busy (I): During idle periods both data line (SDA) and clock line (SCL) remain HIGH.

START condition (ST): A HIGH to LOW transition of SDA line while the clock (SCL) is HIGH is interpreted as START condition. START conditions are always set by the master. Each initial request for a pressure value has to begin with a START condition.

Slave address (An): The I2C-bus requires a unique address for each device. The DLLR sensor has a preconfigured slave address (defined by device option, see Table 9). After setting a START condition the master sends the address byte containing the 7 bit sensor address followed by a data direction bit (R/W). A "0" indicates a transmission from master to slave (WRITE), a "1" indicates a device-to-master request (READ).

Acknowledge (A or N): Data is transferred in units of 8 bits (1 byte) at a time, MSB first. Each data-receiving device, whether master or slave, is required to pull the data line LOW to acknowledge receipt of the data. The Master must generate an extra clock pulse for this purpose. If the receiver does not pull the data line down, a NACK condition exists, and the slave transmitter becomes inactive. The master determines whether to send the last command again or to set the STOP condition, ending the transfer.

DATA valid (Dn): State of data line represents valid data when, after a START condition, data line is stable for duration of HIGH period of clock signal. Data on line must be changed during LOW period of clock signal. There is one clock pulse per data bit.

STOP condition (P): LOW to HIGH transition of the SDA line while clock (SCL) is HIGH indicates a STOP condition. STOP conditions are always generated by the master.

Figure 3 - I2C Communication Diagram

1. Measurement Commands: Start-Single (to start reading of single sample):

Start-Single	C7...C0: 0xAA
Start-Average2	C7...C0: 0xAC
Start-Average4	C7...C0: 0xAD
Start-Average8	C7...C0: 0xAE
Start-Average16	C7...C0: 0xAF



2. Status Read:



3. Data Read:



Bus states:	I
Start:	ST
Stop:	SP
Ack:	A
Nack:	N
"Read" bit (1):	R
"Write" bit (0):	W

Sensor Address:	A6 ... A0
Command Bits:	C7 ... C0

Data bits:	S7 ... S0
Status:	P23 ... P0
Pressure data:	T23 ... T0
Temperature data:	



SPI Interface

SPI Command Sequence

As with the I2C interface configuration, the part enters Idle state after power-up, and waits for a command from the SPI master. To start a measurement cycle, one of the 3- byte Measurement Commands (see Table 1) must be issued by the master. To start a memory read operation, the memory read request (see Table 3) must be sent.

The data returned by the sensor during this command request consists of the Status Byte followed by two undefined data bytes.

On successful decode of a measurement command, the EOC pin is set Low as the core goes into Active state for measurement and calculation. When complete, updated sensor data is written to the output registers, and the core goes back to the Idle state. The EOC pin is set to a High level at this point, and the Busy status bit is set to 0. At any point during the Active or Idle periods, the SPI master can request the Status Byte by sending a Status Read command (a single byte with value 0xF0).

As with the I2C configuration, a Busy bit of value 0 in the Status Byte or a high level on the EOC pin indicates that a valid data set may be read from the sensor. The Data Read command must be sent from the SPI master (The first byte of value 0xF0 followed by 6 bytes of 0x00). For memory read operations, see Table 4 for reading back the result.

NOTE: Sending commands that are not defined in Tables 1, 3, or 4 will corrupt sensor operation.

SPI Bus Communications Overview

The sequence of bits and bus signals are shown in the following illustration (Figure 4). Refer to Figure 5 in the Interface Timing Diagram section for detailed timing data.

Figure 4 - SPI Communications Diagram



Interface Timing Diagrams

Figure 5 - SPI Timing Diagram



PARAMETER	SYMBOL	MIN	TYP	MAX	UNITS
SCLK frequency ⁽¹⁾	f _{SCLK}	0.05	-	5	MHz
SS low to first clock edge	t _{SSCLK}	120	-	-	ns
SS low to serial out	t _{SSSO}	--	-	20	ns
Clock to data out	t _{CLKD}	8	-	32	ns
SCLK low width	t _{LOW}	100	-	-	ns
SCLK high width	t _{HIGH}	100	-	-	ns
Data setup to clock	t _{DSU}	50	-	-	ns
Data hold after clock	t _{DHF}	50	-	-	ns
Last clock to rising SS	t _{CLKSS}	0	-	-	ns
SS high to output hi-Z	t _{SSZ}	--	-	20	ns
Bus idle time	t _{IDLE}	250	-	-	ns

(1) Maximum by design, tested to 1.0 MHz.

Figure 6 - I2C Timing Diagram

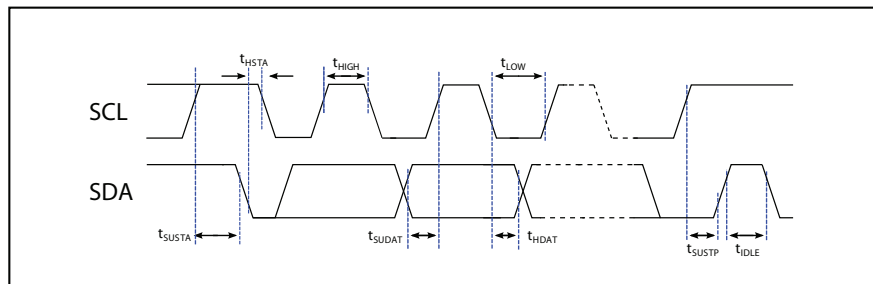

PARAMETER	SYMBOL	MIN	TYP	MAX	UNITS
SCL frequency	f _{SCL}	100	-	400	KHz
SCL low width	t _{LOW}	1.3	-	-	µs
SCL high width	t _{HIGH}	0.6	-	-	µs
Start condition setup	t _{SUSTA}	0.6	-	-	µs
Start condition hold	t _{HSTA}	0.6	-	-	µs
Data setup to clock	t _{SUDAT}	0.1	-	-	µs
Data hold to clock	t _{HDAT}	0	-	-	µs
Stop condition setup	t _{SUSTP}	0.6	-	-	µs
Bus idle time	t _{IDLE}	2.0	-	-	µs

Extended Compensation Instructions

DLLR Series sensors have internal memory locations containing extended compensation coefficients. For optimal accuracy of pressure readings, system designers can use these values to apply an additional 3rd-order error-correction adjustment to data delivered from the sensor, as well as additional temperature compensation.

The four linearity coefficients are obtained for each sensor at the factory by a 3rd order minimization solution to

Error = Pref - (POut + f(POut)), where

Pref is the true pressure applied;

POut is the sensor output;

f(POut) is a cubic correction function, Ax^3+Bx^2+Cx+D .

For improved accuracy over temperature, residual temperature dependent errors are minimized by the term:

$TC_{adj} = (1 - (E * 1.25 * |0.5 - P|)) * (T - T_{ref}) * TC50$

where:

$TC50 = TC50H$ for $T > T_{ref}$

$TC50 = TC50L$ for $T \leq T_{ref}$

On system startup:

Read the seven coefficients (**A, B, C, D, E, TC50H, & TC50L**) from sensor EEPROM, using the command sequence described in the datasheet section 'Digital Interface Command Formats'.

A, B, C & D are 32-bit signed integers, representing a scaled magnitude from -1.0 to +1.0.

E, TC50H, & TC50L are 8-bit signed integers, representing a scaled magnitude from -1.0 to +1.0.

Example:

```
// I2C Input, output buffers:
unsigned char inbuf[32] = {0}, outbuf[32] = {0};
// ----- DLLR Coefficients -----
float DLLR_A = 0.0, DLLR_B = 0.0, DLLR_C = 0.0, DLLR_D = 0.0;
float DLLR_E = 0.0, TC50H = 0.0, TC50L = 0.0;
int32_t i32A = 0, i32B = 0, i32C = 0, i32D = 0;
int8_t i8E = 0, i8TC50H = 0, i8TC50L = 0;
```

After sensor power-on:

```
outbuf[0] = 47; // Address of A high word
success = DUT_I2C_Write(ui8Address, outbuf, 1); // 1-byte request
Wait_ms(20); // EEPROM access time : returns [Status][MSB][LSB]
success = DUT_I2C_Read(ui8Address, inbuf, 3); // EEPROM result
i32A = (inbuf[1] << 24) | (inbuf[2] <<16); // Assemble MSBs
outbuf[0] = 48; // Address of A low word
success = DUT_I2C_Write(ui8Address, outbuf, 1); // 1-byte request
Wait_ms(20); // EEPROM access time
success = DUT_I2C_Read(ui8Address, inbuf, 3); // EEPROM result
i32A |= ((inbuf[1] << 8) | (inbuf[2])); // assemble LSBs, for int32
DLLR_A = ((float) (i32A)) / ((float) (0x7FFFFFFF)); // convert to float

outbuf[0] = 49;
success = DUT_I2C_Write(ui8Address, outbuf, 1);
Wait_ms(20);
success = DUT_I2C_Read(ui8Address, inbuf, 3);
i32B = (inbuf[1] << 24) | (inbuf[2] <<16);
outbuf[0] = 50;
success = DUT_I2C_Write(ui8Address, outbuf, 1);
Wait_ms(20);
success = DUT_I2C_Read(ui8Address, inbuf, 3);
i32B |= ((inbuf[1] << 8) | (inbuf[2]));
DLLR_B = (float) (i32B) / (float) (0x7FFFFFFF);
```

Extended Compensation Instructions (Cont'd)

```
outbuf[0] = 51;
success = DUT_I2C_Write(ui8Address, outbuf, 1);
Wait_ms(20);
success = DUT_I2C_Read(ui8Address, inbuf, 3);
i32C = (inbuf[1] << 24) | (inbuf[2] <<16);
outbuf[0] = 52;
success = DUT_I2C_Write(ui8Address, outbuf, 1);
Wait_ms(20);
success = DUT_I2C_Read(ui8Address, inbuf, 3);
i32C |= ((inbuf[1] << 8) | (inbuf[2]));
DLLR_C = (float) (i32C)/(float) (0x7FFFFFFF);
```

```
outbuf[0] = 53;
success = DUT_I2C_Write(ui8Address, outbuf, 1);
Wait_ms(20);
success = DUT_I2C_Read(ui8Address, inbuf, 3);
i32D = (inbuf[1] << 24) | (inbuf[2] <<16);
outbuf[0] = 54;
success = DUT_I2C_Write(ui8Address, outbuf, 1);
Wait_ms(20);
success = DUT_I2C_Read(ui8Address, inbuf, 3);
i32D |= ((inbuf[1] << 8) | (inbuf[2]));
DLLR_D = (float) (i32D)/(float) (0x7FFFFFFF);
```

```
outbuf[0] = 55;
success = DUT_I2C_Write(ui8Address, outbuf, 1);
Wait_ms(20);
success = DUT_I2C_Read(ui8Address, inbuf, 3);
i16E = ((inbuf[1] << 8) | (inbuf[2]));
i8TC50H = inbuf [1]; i8TC50L = inbuf [2];
TC50H = (float) (i8TC50H)/(float) (0x7F);
TC50L = (float) (i8TC50L)/(float) (0x7F);
```

```
outbuf[0] = 56;
success = DUT_I2C_Write(ui8Address, outbuf, 1);
Wait_ms(20);
success = DUT_I2C_Read(ui8Address, inbuf, 3);
i8E = inbuf [1];
DLLR_E = (float) (i8E)/(float) (0x7F);
```

Correction applied to each reading:

For each pressure value read from the sensor (POut), calculate

$$PCorrected = POut + A*POut^3+B*POut^2+C*POut +D+TCadj.$$

Example:

(Start first reading:)

```
outbuf[0] = 0xAD; // Avg4 request = 0xAD
rc = DUT_I2C_Write(ui8Address, outbuf, 1) // send 1-byte request
```



Extended Compensation Instructions (Cont'd)

After conversion delay (or on EOC pin), read result and apply correction:

```
rc = DUT_I2C_Read(ui8Address, inbuf, 7); // read 7 bytes: Status, P, T
float AP3, BP2, CP, LCorr, PCorr, Padj, TCadj, TC50;
int32_t iPraw, Tdiff, Tref, iTemp, iPCorrected;
uint32_t uiPCorrected;

//DLLR: Modify sensor P value:
iPraw = (inbuf[1]<<16) + (inbuf[2]<<8) + inbuf[3] - 0x800000;
iTemp = (inbuf[4]<<16) + (inbuf[5]<<8) + inbuf[6];
Pnorm = (float)iPraw;
Pnorm /= (float) 0x7FFFFFFF;
AP3 = DLLR_A * Pnorm * Pnorm * Pnorm;           // A*POut2
BP2 = DLLR_B * Pnorm * Pnorm;                 // B*POut2
CP = DLLR_C * Pnorm;                          // C*POut
LCorr = AP3 + BP2 + CP + DLLR_D;              // Linearity correction term

// Compute Temperature - Dependent Adjustment:
Tref = (int32_t)((224)*65/125); // Reference Temperature, in sensor counts
Tdiff = iTemp - Tref;
//TC50: Select High/Low, based on sensor temperature reading:
if (iTemp > Tref)
    TC50 = TC50H;
else
    TC50 = TC50L;
if (Pnorm > 0.5)
    Padj = Pnorm - 0.5;
else
    Padj = 0.5 - Pnorm;
TCadj = (1.0 - (DLLR_E * 1.25 * Padj)) * Tdiff * TC50;

PCorr = Pnorm + LCorr + TCadj;                // corrected P: float, ±1.0
iPCorrected = (int32_t)(PCorr*(float)0x7FFFFFFF); // corrected P: signed int32

//corrected P: 24-bit unsigned value same unsigned format as sensor output
uiPCorrected = (uint32_t) (iPCorrected + 0x800000);
```

(Start next reading:)

```
outbuf[0] = 0xAD;                               // Avg4 request = 0xAD
rc = DUT_I2C_Write(ui8Address, outbuf, 1)       // send 1-byte request
```

Convert to pressure units:

The **PCorrected** result represents the corrected, signed 24-bit output of the sensor (**iPCorrected** in example code). This dimensionless value is then used to compute the final result in appropriate units. For example, if the calibrated range is +/- 10 inH₂O,

$$P_{\text{inH}_2\text{O}} = 1.25 * (\text{PCorrected} / 2^{23}) * 10 \text{ inH}_2\text{O}$$

where the 1.25 factor represents the scaling of full-scale output to the calibrated range (Output at Minimum pressure = 10% of full scale, output at Maximum pressure = 90%); and division by 2²³ resolves PCorrected (range +/- 2²³) into a +/-1.0 scaling value.

How to Order

Refer to Table 8 for configuring a standard base part number which includes the pressure range, package and temperature range. Table 9 shows the available configuring options. The option identifier is required to complete the device part number. Refer to Table 10 for the available device packages.

Example P/N with options: DLLR-L10D-E1NS-C-NAV6

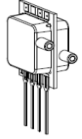

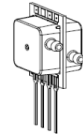

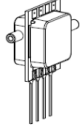

Table 8 - How to configure a base part number

ORDERING INFORMATION	SERIES	PRESSURE RANGE		PACKAGE						TEMPERATURE RANGE		
	ID	ID	Description	Base		Port Orientation		Lid Style		Lead Type		
	DLLR	L10D	±10 inH2O	ID	Description	ID	Description	ID	Description	ID	Description	
		L10G	0 to 10 inH2O	E	1	Dual Port Same Side	N	Non-Barbed	S	SIP <small>(see note 11)</small>	C	Commercial
		L30D	±30 inH2O		2	Dual Port Opposite Side	B	Barbed	D	DIP		
		L30G	0 to 30 inH2O						J	J-Lead SMT		
Example	DLLR	L10D		E	1		N		S		C	

Table 9 - How to configure an option identifier

ORDERING INFORMATION	COATING		INTERFACE		SUPPLY VOLTAGE		RESOLUTION	
	ID	Description	ID	Description	ID	Description	ID	Description
	N	No Coating	A	Auto I2C, address 0x29/SPI	V	1.68V to 3.6V	6	16 Bit
		2	Auto I2C, address 0x28/SPI			7	17 bit	
		3	Auto I2C, address 0x38/SPI			8	18 bit	
		4	Auto I2C, address 0x48/SPI					
		5	Auto I2C, address 0x58/SPI					
		6	Auto I2C, address 0x68/SPI					
		7	Auto I2C, address 0x78/SPI					
Example	N		A		V		6	

Table 10 - Available E-Series Package Configurations

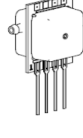
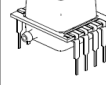
Port Orientation	Non-Barbed Lid Lead Style				Barbed Lid Lead Style			
	SIP ⁽¹⁾	DIP	J Lead SMT	Low Profile DIP	SIP ⁽¹⁾	DIP	J Lead SMT	Low Profile DIP
Dual Port Same Side	 E1NS	 E1ND	 E1NJ	N/A	 E1BS	 E1BD	N/A	N/A
Dual Port Opposite Side	 E2NS	 E2ND	 E2NJ	N/A	 E2BS	 E2BD	N/A	N/A
Single Port (Gage)	N/A	N/A	N/A	N/A	N/A	N/A	N/A	N/A

Specification Notes (Cont.)

NOTE 11: SPI INTERFACE IS ONLY AVAILABLE IN 8-LEAD DIP PACKAGES.



Package Drawings

E1NS Package



Pinout

- 1) Gnd
- 2) Vs
- 3) SDA
- 4) SCL

NOTES
 1) Dimensions are in inches [mm]
 2) For suggested pad layout, see drawing: PAD-01

E1BS Package

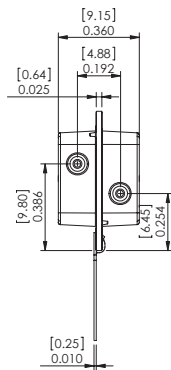

Pinout

- 1) Gnd
- 2) Vs
- 3) SDA
- 4) SCL

NOTES
 1) Dimensions are in inches [mm]
 2) For suggested pad layout, see drawing: PAD-01

Package Drawings (Cont'd)

E2NS Package



Pinout

- 1) Gnd
- 2) Vs
- 3) SDA
- 4) SCL

NOTES

- 1) Dimensions are in inches [mm]
- 2) For suggested pad layout, see drawing: PAD-01

E2BS Package



Pinout

- 1) Gnd
- 2) Vs
- 3) SDA
- 4) SCL

NOTES

- 1) Dimensions are in inches [mm]
- 2) For suggested pad layout, see drawing: PAD-01

Package Drawings (Cont'd)

E1ND Package

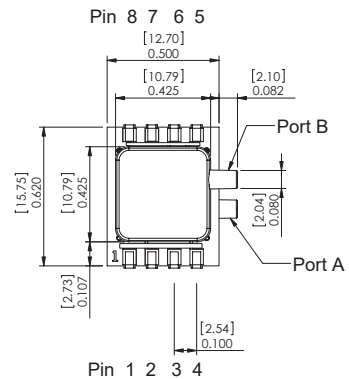

Pinout

- 1) Gnd
- 2) Vs
- 3) SDA/MOSI
- 4) SCL/SCLK
- 5) EOC
- 6) MISO
- 7) Not Connected
- 8) /SS

NOTES

- 1) Dimensions are in inches [mm]
- 2) For suggested pad layout, see drawing: PAD-03

E1BD Package

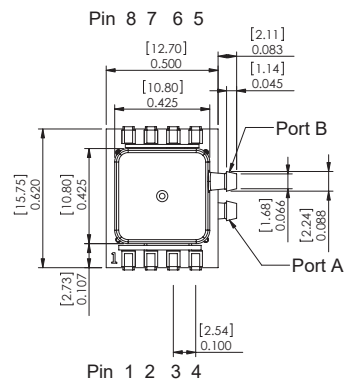

Pinout

- 1) Gnd
- 2) Vs
- 3) SDA/MOSI
- 4) SCL/SCLK
- 5) EOC
- 6) MISO
- 7) Not Connected
- 8) /SS

NOTES

- 1) Dimensions are in inches [mm]
- 2) For suggested pad layout, see drawing: PAD-03

Package Drawings (Cont'd)

E2ND Package

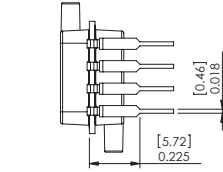

Pinout

- 1) Gnd
- 2) Vs
- 3) SDA/MOSI
- 4) SCL/SCLK
- 5) EOC
- 6) MISO
- 7) Not Connected
- 8) /SS



NOTES

- 1) Dimensions are in inches [mm]
- 2) For suggested pad layout, see drawing: PAD-03

E2BD Package

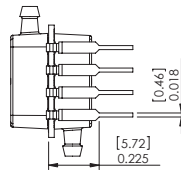

Pinout

- 1) Gnd
- 2) Vs
- 3) SDA/MOSI
- 4) SCL/SCLK
- 5) EOC
- 6) MISO
- 7) Not Connected
- 8) /SS



NOTES

- 1) Dimensions are in inches [mm]
- 2) For suggested pad layout, see drawing: PAD-03



Package Drawings (Cont'd)

E1NJ Package



DETAIL A
SCALE 4 : 1

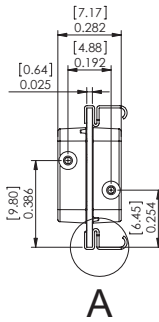

Pinout

- 1) Gnd
- 2) Vs
- 3) SDA/MOSI
- 4) SCL/SCLK
- 5) EOC
- 6) MISO
- 7) Not Connected
- 8) /SS

NOTES

- 1) Dimensions are in inches [mm]
- 2) For suggested pad layout, see drawing: PAD-10

E2NJ Package



DETAIL A
SCALE 4 : 1

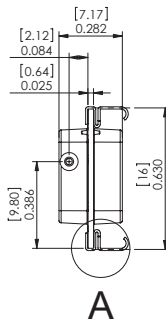

Pinout

- 1) Gnd
- 2) Vs
- 3) SDA/MOSI
- 4) SCL/SCLK
- 5) EOC
- 6) MISO
- 7) Not Connected
- 8) /SS

NOTES

- 1) Dimensions are in inches [mm]
- 2) For suggested pad layout, see drawing: PAD-10

Suggested Pad Layout



PAD-01



PAD-03



PAD-10

Product Labeling



All Sensors reserves the right to make changes to any products herein. All Sensors does not assume any liability arising out of the application or use of any product or circuit described herein, neither does it convey any license under its patent rights nor the rights of others.





Компания «ЭлектроПласт» предлагает заключение долгосрочных отношений при поставках импортных электронных компонентов на взаимовыгодных условиях!

Наши преимущества:

- Оперативные поставки широкого спектра электронных компонентов отечественного и импортного производства напрямую от производителей и с крупнейших мировых складов;
- Поставка более 17-ти миллионов наименований электронных компонентов;
- Поставка сложных, дефицитных, либо снятых с производства позиций;
- Оперативные сроки поставки под заказ (от 5 рабочих дней);
- Экспресс доставка в любую точку России;
- Техническая поддержка проекта, помощь в подборе аналогов, поставка прототипов;
- Система менеджмента качества сертифицирована по Международному стандарту ISO 9001;
- Лицензия ФСБ на осуществление работ с использованием сведений, составляющих государственную тайну;
- Поставка специализированных компонентов (Xilinx, Altera, Analog Devices, Intersil, Interpoint, Microsemi, Aeroflex, Peregrine, Syfer, Eurofarad, Texas Instrument, Miteq, Cobham, E2V, MA-COM, Hittite, Mini-Circuits, General Dynamics и др.);

Помимо этого, одним из направлений компании «ЭлектроПласт» является направление «Источники питания». Мы предлагаем Вам помощь Конструкторского отдела:

- Подбор оптимального решения, техническое обоснование при выборе компонента;
- Подбор аналогов;
- Консультации по применению компонента;
- Поставка образцов и прототипов;
- Техническая поддержка проекта;
- Защита от снятия компонента с производства.



Как с нами связаться

Телефон: 8 (812) 309 58 32 (многоканальный)

Факс: 8 (812) 320-02-42

Электронная почта: org@eplast1.ru

Адрес: 198099, г. Санкт-Петербург, ул. Калинина, дом 2, корпус 4, литера А.