



Panasonic

ideas for life

New pin layout (LT type) added. Ultra high sensitivity realized at 50 mW nominal operating power

TX-S RELAYS



Compliance with RoHS Directive

FEATURES

1. Nominal operating power:

High sensitivity of 50mW

By using the highly efficient polar magnetic circuit "seesaw balance mechanism", a nominal operating power of 50 mW (minimum operating power of 32 mW) has been achieved.

2. Compact size

15.0(L) × 7.4(W) × 8.2(H) .591(L) × .291(W) × .323(H)

3. High contact reliability

High contact reliability is achieved by the use of gold-clad twin crossbar contacts, low-gas formation materials, mold sealing the coil section, and by controlling organic gas in the coil.

***We also offer a range of products with AgPd contacts suitable for use in low level load analog circuits (Max. 10V DC 10 mA).**

4. Outstanding surge resistance.

Surge breakdown voltage between open contacts:
1,500 V 10×160 μsec. (FCC part 68)
Surge breakdown voltage between contact and coil:
2,500 V 2×10 μsec. (Telcordia)

5. Low thermal electromotive force (approx. 0.3 μV)

The structure of the mold-sealed body block of the coil section achieves nominal operating power of 50 mW and high sensitivity, along with low thermal electromotive force, reduced to approximately 0.3 μV.

6. A range of surface-mount types is also available.

SA: Low-profile surface-mount terminal type

⚠SL: High connection reliability surface-mount terminal type

SS: Space saving surface-mount terminal type

7. Sealed construction allows automatic washing.

TYPICAL APPLICATIONS

1. Communications (XDSL, Transmission)

2. Measurement

3. Security

4. Home appliances, and audio/visual equipment

5. Automotive equipment

6. Medical equipment

ORDERING INFORMATION



Contact arrangement
2: 2 Form C

Surface-mount availability

Nil: Standard PC board terminal type or self-clinching terminal type ⚠

SA: SA type

SL: SL type ⚠

SS: SS type

Operating function

Nil: Single side stable

L: 1 coil latching

L2: 2 coil latching

LT: 2 coil latching

Terminal shape

Nil: Standard PC board terminal or surface-mount terminal

H: Self-clinching terminal ⚠

Nominal coil voltage (DC)

1.5, 3, 4.5, 6, 9, 12, 24V

Contact material

Nil: Standard contact (Ag+Au clad)

1: AgPd contact (low level load); AgPd+Au clad (stationary), AgPd (movable)

Packing style

Nil: Tube packing

X: Tape and reel (picked from 1/3/4/5-pin side)

Z: Tape and reel packing (picked from the 8/9/10/12-pin side)



TYPES

1. Standard PC board terminal

Contact arrangement	Nominal coil voltage	Single side stable	1 coil latching	2 coil latching (L2)	2 coil latching (LT)
		Part No.	Part No.	Part No.	Part No.
2 Form C	1.5V DC	TXS2-1.5V	TXS2-L-1.5V	TXS2-L2-1.5V	TXS2-LT-1.5V
	3V DC	TXS2-3V	TXS2-L-3V	TXS2-L2-3V	TXS2-LT-3V
	4.5V DC	TXS2-4.5V	TXS2-L-4.5V	TXS2-L2-4.5V	TXS2-LT-4.5V
	6V DC	TXS2-6V	TXS2-L-6V	TXS2-L2-6V	TXS2-LT-6V
	9V DC	TXS2-9V	TXS2-L-9V	TXS2-L2-9V	TXS2-LT-9V
	12V DC	TXS2-12V	TXS2-L-12V	TXS2-L2-12V	TXS2-LT-12V
	24V DC	TXS2-24V	TXS2-L-24V	TXS2-L2-24V	TXS2-LT-24V

Standard packing: Tube: 40 pcs.; Case: 1,000 pcs.

Note: Please add "-1" to the end of the part number for AgPd contacts (low level load).

2. Self-clinching terminal

Contact arrangement	Nominal coil voltage	Single side stable	1 coil latching	2 coil latching (L2)	2 coil latching (LT)
		Part No.	Part No.	Part No.	Part No.
2 Form C	1.5V DC	TXS2-H-1.5V	TXS2-L-H-1.5V	TXS2-L2-H-1.5V	TXS2-LT-H-1.5V
	3V DC	TXS2-H-3V	TXS2-L-H-3V	TXS2-L2-H-3V	TXS2-LT-H-3V
	4.5V DC	TXS2-H-4.5V	TXS2-L-H-4.5V	TXS2-L2-H-4.5V	TXS2-LT-H-4.5V
	6V DC	TXS2-H-6V	TXS2-L-H-6V	TXS2-L2-H-6V	TXS2-LT-H-6V
	9V DC	TXS2-H-9V	TXS2-L-H-9V	TXS2-L2-H-9V	TXS2-LT-H-9V
	12V DC	TXS2-H-12V	TXS2-L-H-12V	TXS2-L2-H-12V	TXS2-LT-H-12V
	24V DC	TXS2-H-24V	TXS2-L-H-24V	TXS2-L2-H-24V	TXS2-LT-H-24V

Standard packing: Tube: 40 pcs.; Case: 1,000 pcs.

Note: Please add "-1" to the end of the part number for AgPd contacts (low level load).

3. Surface-mount terminal

1) Tube packing

Contact arrangement	Nominal coil voltage	Single side stable	1 coil latching	2 coil latching (L2)	2 coil latching (LT)
		Part No.	Part No.	Part No.	Part No.
2 Form C	1.5V DC	TXS2S□-1.5V	TXS2S□-L-1.5V	TXS2S□-L2-1.5V	TXS2S□-LT-1.5V
	3V DC	TXS2S□-3V	TXS2S□-L-3V	TXS2S□-L2-3V	TXS2S□-LT-3V
	4.5V DC	TXS2S□-4.5V	TXS2S□-L-4.5V	TXS2S□-L2-4.5V	TXS2S□-LT-4.5V
	6V DC	TXS2S□-6V	TXS2S□-L-6V	TXS2S□-L2-6V	TXS2S□-LT-6V
	9V DC	TXS2S□-9V	TXS2S□-L-9V	TXS2S□-L2-9V	TXS2S□-LT-9V
	12V DC	TXS2S□-12V	TXS2S□-L-12V	TXS2S□-L2-12V	TXS2S□-LT-12V
	24V DC	TXS2S□-24V	TXS2S□-L-24V	TXS2S□-L2-24V	TXS2S□-LT-24V

□: For each surface-mounted terminal identification, input the following letter. SA type: A, SL type: L, SS type: S

Standard packing: Tube: 40 pcs.; Case: 1,000 pcs.

Note: Please add "-1" to the end of the part number for AgPd contacts (low level load).

2) Tape and reel packing

Contact arrangement	Nominal coil voltage	Single side stable	1 coil latching	2 coil latching (L2)	2 coil latching (LT)
		Part No.	Part No.	Part No.	Part No.
2 Form C	1.5V DC	TXS2S□-1.5V-Z	TXS2S□-L-1.5V-Z	TXS2S□-L2-1.5V-Z	TXS2S□-LT-1.5V-Z
	3V DC	TXS2S□-3V-Z	TXS2S□-L-3V-Z	TXS2S□-L2-3V-Z	TXS2S□-LT-3V-Z
	4.5V DC	TXS2S□-4.5V-Z	TXS2S□-L-4.5V-Z	TXS2S□-L2-4.5V-Z	TXS2S□-LT-4.5V-Z
	6V DC	TXS2S□-6V-Z	TXS2S□-L-6V-Z	TXS2S□-L2-6V-Z	TXS2S□-LT-6V-Z
	9V DC	TXS2S□-9V-Z	TXS2S□-L-9V-Z	TXS2S□-L2-9V-Z	TXS2S□-LT-9V-Z
	12V DC	TXS2S□-12V-Z	TXS2S□-L-12V-Z	TXS2S□-L2-12V-Z	TXS2S□-LT-12V-Z
	24V DC	TXS2S□-24V-Z	TXS2S□-L-24V-Z	TXS2S□-L2-24V-Z	TXS2S□-LT-24V-Z

□: For each surface-mounted terminal identification, input the following letter. SA type: A, SL type: L, SS type: S

Standard packing: Tape and reel: 500 pcs.; Case: 1,000 pcs.

Notes: 1. Tape and reel packing symbol "-Z" is not marked on the relay. "X" type tape and reel packing (picked from 1/2/3/4-pin side) is also available.

2. Please add "-1" to the end of the part number for AgPd contacts (low level load). (Ex. TXS2SA-1.5V-1-Z)

RATING

1. Coil data

1) Single side stable

Nominal coil voltage	Pick-up voltage (at 20°C 68°F)	Drop-out voltage (at 20°C 68°F)	Nominal operating current [±10%] (at 20°C 68°F)	Coil resistance [±10%] (at 20°C 68°F)	Nominal operating power	Max. applied voltage (at 20°C 68°F)
1.5V DC	80%V or less of nominal voltage* (Initial)	10%V or more of nominal voltage* (Initial)	33.3mA	45Ω	50mW	150%V of nominal voltage
3V DC			16.7mA	180Ω		
4.5V DC			11.1mA	405Ω		
6V DC			8.3mA	720Ω		
9V DC			5.6mA	1,620Ω		
12V DC			4.2mA	2,880Ω		
24V DC			2.9mA	8,229Ω	70mW	



Partly Order Discontinued as of August 31, 2011

TX-S

2) 1 coil latching

Nominal coil voltage	Set voltage (at 20°C 68°F)	Reset voltage (at 20°C 68°F)	Nominal operating current [±10%] (at 20°C 68°F)	Coil resistance [±10%] (at 20°C 68°F)	Nominal operating power	Max. applied voltage (at 20°C 68°F)
1.5V DC	80%V or less of nominal voltage* (Initial)	80%V or less of nominal voltage* (Initial)	23.3mA	64.3Ω	35mW	150%V of nominal voltage
3V DC			11.7mA	257Ω		
4.5V DC			7.8mA	579Ω		
6V DC			5.8mA	1,029Ω		
9V DC			3.9mA	2,314Ω		
12V DC			2.9mA	4,114Ω		
24V DC			2.1mA	11,520Ω	50mW	

3) 2 coil latching (L2, LT)

Nominal coil voltage	Set voltage (at 20°C 68°F)	Reset voltage (at 20°C 68°F)	Nominal operating current [±10%] (at 20°C 68°F)		Coil resistance [±10%] (at 20°C 68°F)		Nominal operating power		Max. applied voltage (at 20°C 68°F)
			Set coil	Reset coil	Set coil	Reset coil	Set coil	Reset coil	
1.5V DC	80%V or less of nominal voltage* (Initial)	80%V or less of nominal voltage* (Initial)	46.7mA	46.7mA	32.1Ω	32.1Ω	70mW	70mW	150%V of nominal voltage
3V DC			23.3mA	23.3mA	129Ω	129Ω			
4.5V DC			15.6mA	15.6mA	289Ω	289Ω			
6V DC			11.7mA	11.7mA	514Ω	514Ω			
9V DC			7.8mA	7.8mA	1,157Ω	1,157Ω	150mW	150mW	
12V DC			5.8mA	5.8mA	2,057Ω	2,057Ω			
24V DC			6.3mA	6.3mA	3,840Ω	3,840Ω			

*Pulse drive (JIS C 5442-1986)

2. Specifications

Characteristics	Item	Specifications	
Contact	Arrangement	2 Form C	
	Initial contact resistance, max.	Max. 100 mΩ (By voltage drop 6 V DC 1A)	
	Contact material	Standard contact: Ag+Au clad, AgPd contact (low level load): AgPd+Au clad (stationary), AgPd (movable)	
Rating	Nominal switching capacity	1 A 30 V DC (resistive load)	
	Max. switching power	30 W (DC) (resistive load)	
	Max. switching voltage	110V DC	
	Max. switching current	1 A	
	Min. switching capacity (Reference value)*1	10μA 10mV DC	
	Nominal operating power	Single side stable 1 coil latching 2 coil latching	50 mW (1.5 to 12 V DC), 70 mW (24 V DC) 35 mW (1.5 to 12 V DC), 50 mW (24 V DC) 70 mW (1.5 to 12 V DC), 150 mW (24 V DC)
Electrical characteristics	Insulation resistance (Initial)	Min. 1,000MΩ (at 500V DC) Measurement at same location as "Initial breakdown voltage" section.	
	Breakdown voltage (Initial)	Between open contacts	750 Vrms for 1min. (Detection current: 10mA)
		Between contact and coil	1,800 Vrms for 1min. (Detection current: 10mA)
		Between contact sets	1,000 Vrms for 1min. (Detection current: 10mA)
	Surge breakdown voltage (Initial)	Between open contacts	1,500 V (10×160μs) (FCC Part 68)
		Between contacts and coil	2,500 V (2×10μs) (Telcordia)
	Temperature rise (at 20°C 68°F)		Max. 50°C (By resistive method, nominal coil voltage applied to the coil; contact carrying current: 1A.)
Operate time [Set time] (at 20°C 68°F)		Max. 5 ms [Max. 5 ms] (Nominal coil voltage applied to the coil, excluding contact bounce time.)	
Release time [Reset time] (at 20°C 68°F)		Max. 5 ms [Max. 5 ms] (Nominal coil voltage applied to the coil, excluding contact bounce time.) (without diode)	
Mechanical characteristics	Shock resistance	Functional	Min. 750 m/s ² (Half-wave pulse of sine wave: 6 ms; detection time: 10μs.)
		Destructive	Min. 1,000 m/s ² (Half-wave pulse of sine wave: 6 ms.)
	Vibration resistance	Functional	10 to 55 Hz at double amplitude of 3.3 mm (Detection time: 10μs.)
		Destructive	10 to 55 Hz at double amplitude of 5 mm
Expected life	Mechanical	Min. 5×10 ⁷ (at 180 cpm)	
	Electrical	Min. 2×10 ⁵ (1 A 30 V DC resistive) (at 20 cpm)	
Conditions	Conditions for operation, transport and storage*2	Ambient temperature: -40°C to +70°C -40°F to +158°F; Humidity: 5 to 85% R.H. (Not freezing and condensing at low temperature)	
	Max. operating speed (at rated load)	20 cpm	
Unit weight		Approx. 2 g .071 oz	

Notes: *1 This value can change due to the switching frequency, environmental conditions, and desired reliability level, therefore it is recommended to check this with the actual load. (AgPd contact type is available for low level load switching [10V DC, 10mA max. level])

*2 Refer to 6. Conditions for operation, transport and storage mentioned in AMBIENT ENVIRONMENT.



REFERENCE DATA

1. Maximum switching capacity



2. Life curve



3. Mechanical life

Tested sample: TXS2-4.5V, 10 pcs.
Operating speed: 180 cpm



4. Electrical life (1 A 30 V DC resistive load)

Tested sample: TXS2-4.5V, 6 pcs.
Operating speed: 20 cpm

Change of pick-up and drop-out voltage



Change of contact resistance



5-(1). Coil temperature rise

Tested sample: TXS2-4.5V, 6 pcs.

Point measured: Inside the coil

Ambient temperature: 25°C 77°F, 70°C 158°F



5-(2). Coil temperature rise

Tested sample: TXS2-24V, 6 pcs.

Point measured: Inside the coil

Ambient temperature: 25°C 77°F, 70°C 158°F



6-(1). Operate and release time (with diode)

Tested sample: TXS2-4.5V, 10 pcs.



6-(2). Operate and release time (without diode)

Tested sample: TXS2-4.5V, 10 pcs.



7. Ambient temperature characteristics

Tested sample: TXS2-4.5V, 5 pcs.



8-(1). High frequency characteristics (Isolation)

Tested sample: TXS2-4.5V, 2 pcs.



8-(2). High frequency characteristics (Insertion loss)

Tested sample: TXS2-4.5V, 2 pcs.





9-(1). Malfunctional shock (single side stable)
Tested sample: TXS2-4.5V, 6 pcs.



9-(2). Malfunctional shock (latching)
Tested sample: TXS2-L2-4.5V, 6 pcs.



10. Thermal electromotive force
Tested sample: TXS2-4.5V, 6 pcs.



11-(1). Influence of adjacent mounting
Tested sample: TXS2-4.5V, 6 pcs.



11-(2). Influence of adjacent mounting
Tested sample: TXS2-4.5V, 6 pcs.



11-(3). Influence of adjacent mounting
Tested sample: TXS2-4.5V, 6 pcs.



12. Pulse dialing test
(35 mA 48V DC wire spring relay load)
Tested sample: TXS2-4.5V, 6 pcs.



Change of pick-up and drop-out voltage



Change of contact resistance



Note: Data of surface-mount type are the same as those of PC board terminal type.



DIMENSIONS (mm inch)

The CAD data of the products with a **CAD Data** mark can be downloaded from: <http://panasonic-electric-works.net/ac>

1. Standard PC board terminal and Self clinching terminal

CAD Data



Type	External dimensions (General tolerance: $\pm 0.3 \pm 0.12$)		PC board pattern (Bottom view) (Tolerance: $\pm 0.1 \pm 0.04$)	
	Single side stable and 1 coil latching type	2 coil latching type (L2, LT)	Single side stable and 1 coil latching type	2 coil latching type (L2, LT)
Standard PC board terminal				
Self clinching terminal				

Schematic (Bottom view)

Single side stable

1 coil latching

2 coil latching (L2)

2 coil latching (LT)



(Deenergized condition)



(Reset condition)



(Reset condition)



(Reset condition)

2. Surface-mount terminal

CAD Data



Type	External dimensions (General tolerance: $\pm 0.3 \pm 0.12$)		Suggested mounting pad (Top view) (Tolerance: $\pm 0.1 \pm 0.04$)	
	Single side stable and 1 coil latching type	2 coil latching type (L2, LT)	Single side stable and 1 coil latching type	2 coil latching type (L2, LT)
SA type				
SL type				
SS type				

Schematic (Top view)



NOTES

1. Packing style

1) The relay is packed in a tube with the relay orientation mark on the left side, as shown in the figure below.

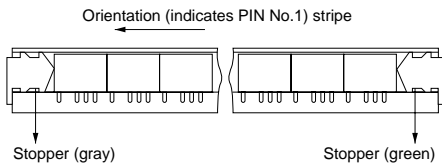

2) Tape and reel packing (surface-mount terminal type)

(1) Tape dimensions
(i) SA type

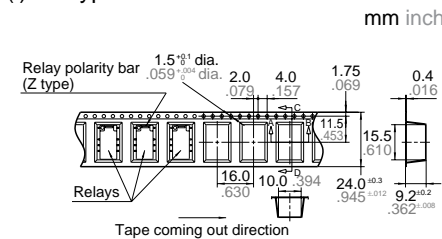

2. Automatic insertion

To maintain the internal function of the relay, the chucking pressure should not exceed the values below.

- Chucking pressure in the direction A: 4.9 N {500gf} or less
- Chucking pressure in the direction B: 9.8 N {1 kgf} or less
- Chucking pressure in the direction C: 9.8 N {1 kgf} or less

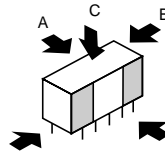

Please chuck the  portion. Avoid chucking the center of the relay. In addition, excessive chucking pressure to the pinpoint of the relay should be avoided.

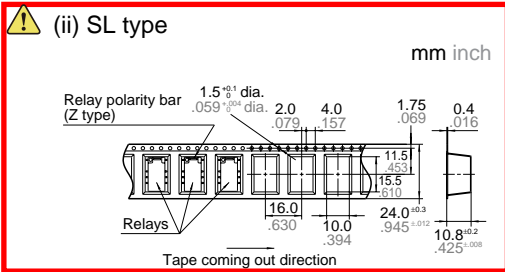

For general cautions for use, please refer to the "Cautions for use of Signal Relays" or "General Application Guidelines".

(iii) SS type

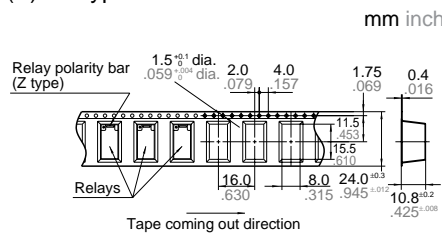

(2) Dimensions of plastic reel

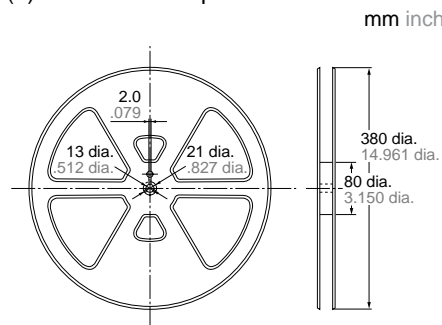



Компания «ЭлектроПласт» предлагает заключение долгосрочных отношений при поставках импортных электронных компонентов на взаимовыгодных условиях!

Наши преимущества:

- Оперативные поставки широкого спектра электронных компонентов отечественного и импортного производства напрямую от производителей и с крупнейших мировых складов;
- Поставка более 17-ти миллионов наименований электронных компонентов;
- Поставка сложных, дефицитных, либо снятых с производства позиций;
- Оперативные сроки поставки под заказ (от 5 рабочих дней);
- Экспресс доставка в любую точку России;
- Техническая поддержка проекта, помощь в подборе аналогов, поставка прототипов;
- Система менеджмента качества сертифицирована по Международному стандарту ISO 9001;
- Лицензия ФСБ на осуществление работ с использованием сведений, составляющих государственную тайну;
- Поставка специализированных компонентов (Xilinx, Altera, Analog Devices, Intersil, Interpoint, Microsemi, Aeroflex, Peregrine, Syfer, Eurofarad, Texas Instrument, Miteq, Cobham, E2V, MA-COM, Hittite, Mini-Circuits, General Dynamics и др.);

Помимо этого, одним из направлений компании «ЭлектроПласт» является направление «Источники питания». Мы предлагаем Вам помощь Конструкторского отдела:

- Подбор оптимального решения, техническое обоснование при выборе компонента;
- Подбор аналогов;
- Консультации по применению компонента;
- Поставка образцов и прототипов;
- Техническая поддержка проекта;
- Защита от снятия компонента с производства.



Как с нами связаться

Телефон: 8 (812) 309 58 32 (многоканальный)

Факс: 8 (812) 320-02-42

Электронная почта: org@eplast1.ru

Адрес: 198099, г. Санкт-Петербург, ул. Калинина, дом 2, корпус 4, литера А.