

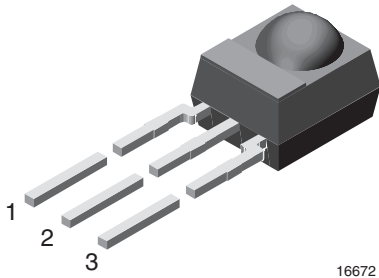

IR Receiver Modules for Remote Control Systems



16672

MECHANICAL DATA

Pinning for TSOP44..., TSOP48...:

1 = OUT, 2 = GND, 3 = V_S

Pinning for TSOP22..., TSOP24...:

1 = OUT, 2 = V_S, 3 = GND

FEATURES

- Low supply current
- Photo detector and preamplifier in one package
- Internal filter for PCM frequency
- Improved shielding against EMI
- Supply voltage: 2.5 V to 5.5 V
- Improved immunity against ambient light
- Insensitive to supply voltage ripple and noise
- Material categorization:
for definitions of compliance please see www.vishay.com/doc?99912



DESCRIPTION

The TSOP22..., TSOP48..., TSOP24.. and TSOP44.. series are miniaturized IR receiver modules for infrared remote control systems. A PIN diode and a preamplifier are assembled on lead frame, the epoxy package contains an IR filter.

The demodulated output signal can be directly connected to a microprocessor for decoding.

The TSOP24..., TSOP44.. are optimized to suppress almost all spurious pulses from energy saving lamps like CFLs. The AGC4 used in the TSOP24.. and TSOP44.. may suppress some data signals. The TSOP22..., TSOP48.. are legacy products for all common IR remote control data formats. Between these four receiver types, the TSOP24..., TSOP44.. are preferred. Customers should initially try the TSOP24..., TSOP44 in their design.

These components have not been qualified according to automotive specifications.

PARTS TABLE					
AGC		LEGACY, FOR LONG BURST REMOTE CONTROLS (AGC2)		RECOMMENDED FOR LONG BURST CODES (AGC4) (1)	
Carrier frequency	30 kHz	TSOP4830	TSOP2230	TSOP4430	TSOP2430
	33 kHz	TSOP4833	TSOP2233	TSOP4433	TSOP2433
	36 kHz	TSOP4836	TSOP2236	TSOP4436 (2)(3)(4)	TSOP2436 (2)(3)(4)
	38 kHz	TSOP4838	TSOP2238	TSOP4438 (5)(6)(7)	TSOP2438 (5)(6)(7)
	40 kHz	TSOP4840	TSOP2240	TSOP4440	TSOP2440
	56 kHz	TSOP4856	TSOP2256	TSOP4456 (7)(8)	TSOP2456 (7)(8)
Package	Mold				
Pinning	1 = OUT, 2 = GND, 3 = V _S	1 = OUT, 2 = V _S , 3 = GND	1 = OUT, 2 = GND, 3 = V _S	1 = OUT, 2 = V _S , 3 = GND	
Dimensions (mm)	6.0 W x 6.95 H x 5.6 D				
Mounting	Leaded				
Application	Remote control				
Best remote control code	(2) RC-5 (3) RC-6 (4) Panasonic (5) NEC (6) Sharp (7) r-step (8) Thomson RCA				

Note

(1) We advise try AGC4 first if the burst length is unknown.

BLOCK DIAGRAM

APPLICATION CIRCUIT

The external components R_1 and C_1 are optional to improve the robustness against electrical overstress (typical values are $R_1 = 100 \Omega$, $C_1 = 0.1 \mu\text{F}$).

ABSOLUTE MAXIMUM RATINGS

PARAMETER	TEST CONDITION	SYMBOL	VALUE	UNIT
Supply voltage		V_S	-0.3 to +6	V
Supply current		I_S	5	mA
Output voltage		V_O	-0.3 to 5.5	V
Voltage at output to supply		$V_S - V_O$	-0.3 to $(V_S + 0.3)$	V
Output current		I_O	5	mA
Junction temperature		T_j	100	$^{\circ}\text{C}$
Storage temperature range		T_{stg}	-25 to +85	$^{\circ}\text{C}$
Operating temperature range		T_{amb}	-25 to +85	$^{\circ}\text{C}$
Power consumption	$T_{\text{amb}} \leq 85 \text{ }^{\circ}\text{C}$	P_{tot}	10	mW
Soldering temperature	$t \leq 10 \text{ s}$, 1 mm from case	T_{sd}	260	$^{\circ}\text{C}$

Note

- Stresses beyond those listed under "Absolute Maximum Ratings" may cause permanent damage to the device. This is a stress rating only and functional operation of the device at these or any other conditions beyond those indicated in the operational sections of this specification is not implied. Exposure to absolute maximum rating conditions for extended periods may affect the device reliability.

ELECTRICAL AND OPTICAL CHARACTERISTICS ($T_{\text{amb}} = 25 \text{ }^{\circ}\text{C}$, unless otherwise specified)

PARAMETER	TEST CONDITION	SYMBOL	MIN.	TYP.	MAX.	UNIT
Supply current	$E_v = 0$, $V_S = 5 \text{ V}$	I_{SD}	0.55	0.7	0.9	mA
	$E_v = 40 \text{ klx}$, sunlight	I_{SH}		0.8		mA
Supply voltage		V_S	2.5		5.5	V
Transmission distance	$E_v = 0$, test signal see fig. 1, IR diode TSAL6200, $I_F = 200 \text{ mA}$	d		45		m
Output voltage low	$I_{\text{OSL}} = 0.5 \text{ mA}$, $E_e = 0.7 \text{ mW/m}^2$, test signal see fig. 1	V_{OSL}			100	mV
Minimum irradiance	Pulse width tolerance: $t_{\text{pi}} - 5/f_o < t_{\text{po}} < t_{\text{pi}} + 6/f_o$, test signal see fig. 1	$E_e \text{ min.}$		0.12	0.25	mW/m^2
Maximum irradiance	$t_{\text{pi}} - 5/f_o < t_{\text{po}} < t_{\text{pi}} + 6/f_o$, test signal see fig. 1	$E_e \text{ max.}$	50			W/m^2
Directivity	Angle of half transmission distance	$\phi_{1/2}$		± 45		deg

TYPICAL CHARACTERISTICS (T_{amb} = 25 °C, unless otherwise specified)



Fig. 1 - Output Active Low

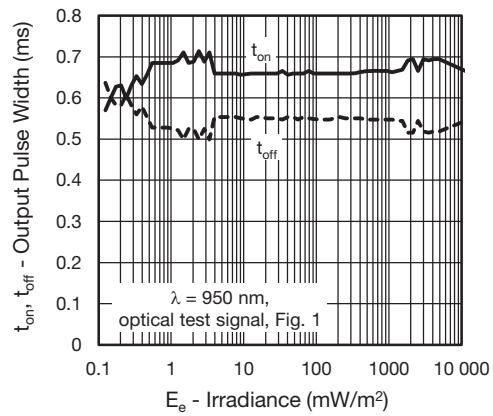

Fig. 4 - Output Pulse Diagram



Fig. 2 - Pulse Length and Sensitivity in Dark Ambient



Fig. 5 - Frequency Dependence of Responsivity

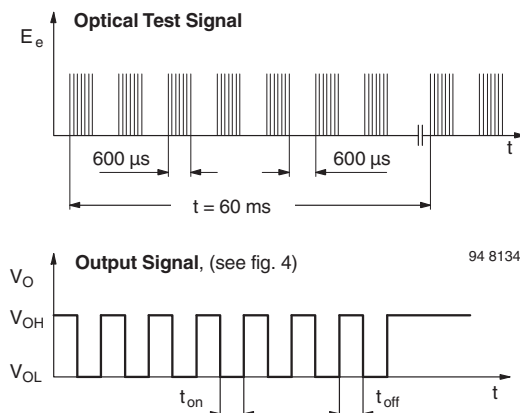

Fig. 3 - Output Function

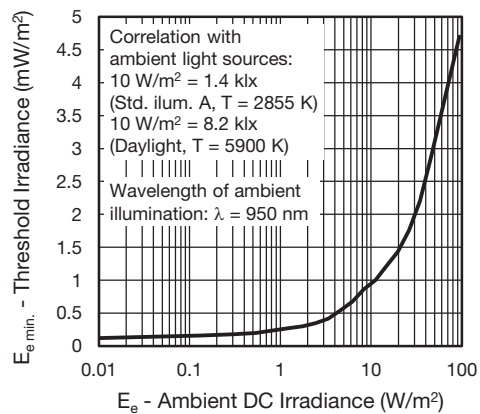

Fig. 6 - Sensitivity in Bright Ambient



Fig. 7 - Sensitivity vs. Supply Voltage Disturbances



Fig. 10 - Relative Spectral Sensitivity vs. Wavelength

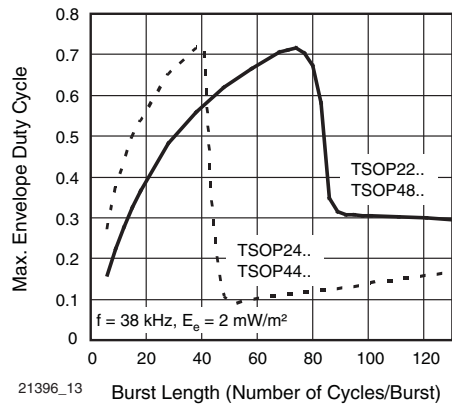

Fig. 8 - Max. Envelope Duty Cycle vs. Burst Length

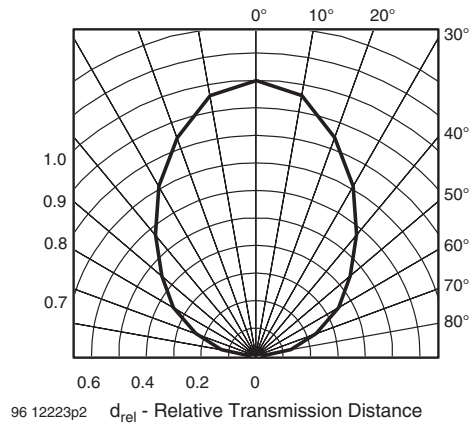

Fig. 11 - Horizontal Directivity



Fig. 9 - Sensitivity vs. Ambient Temperature



Fig. 12 - Sensitivity vs. Supply Voltage

SUITABLE DATA FORMAT

This series is designed to suppress spurious output pulses due to noise or disturbance signals. The devices can distinguish data signals from noise due to differences in frequency, burst length, and envelope duty cycle. The data signal should be close to the device's band-pass center frequency (e.g. 38 kHz) and fulfill the conditions in the table below.

When a data signal is applied to the product in the presence of a disturbance, the sensitivity of the receiver is automatically reduced by the AGC to insure that no spurious pulses are present at the receiver's output. Some examples which are suppressed are:

- DC light (e.g. from tungsten bulbs sunlight)
- Continuous signals at any frequency
- Strongly or weakly modulated patterns from fluorescent lamps with electronic ballasts (see figure 13 or figure 14).



Fig. 13 - IR Disturbance from Fluorescent Lamp with Low Modulation



Fig. 14 - IR Disturbance from Fluorescent Lamp with High Modulation

	TSOP22..., TSOP48..	TSOP24..., TSOP44..
Minimum burst length	10 cycles/burst	10 cycles/burst
After each burst of length a minimum gap time is required of	10 to 70 cycles ≥ 12 cycles	10 to 35 cycles ≥ 12 cycles
For bursts greater than a minimum gap time in the data stream is needed of	70 cycles > 4 x burst length	35 cycles > 10 x burst length
Maximum number of continuous short bursts/second	800	1300
NEC code	yes	preferred
RC5/RC6 code	yes	preferred
Thomson 56 kHz code	yes	preferred
Sharp code	yes	preferred
Suppression of interference from fluorescent lamps	Most common disturbance patterns are suppressed	Even extreme disturbance patterns are suppressed

Notes

- For data formats with short bursts please see the datasheet of TSOP23..., TSOP43..
- Best choice of AGC for some popular IR-codes:
 - TSOP4436, TSOP2436: RC-5, RC-6, Panasonic
 - TSOP4438, TSOP2438: NEC, Sharp, r-step
 - TSOP4456, TSOP2456: r-step, Thomson RCA
- For SIRCS 15 and 20 bit, Sony 12 bit IR-codes, please see the datasheet for TSOP4S40, TSOP2S40



PACKAGE DIMENSIONS in millimeters



Drawing-No.: 6.550-5169.01-4
 Issue: 9; 03.11.10
 13655



IR Receiver Modules for Remote Control Systems

Vishay offers stock molded IR receivers in four different packages:

- Loose packed in tubes, mounted on tape for reel or ammopack, or packed bulk in plastic bags.
- Vishay IR receiver with metal holders are packed in plastic trays. Vishay IR receiver with plastic holders are packed in plastic tubes.



FEATURES

- Material categorization:
For definitions of compliance please see www.vishay.com/doc?99912



AVAILABLE FOR

- TSOP348..
- TSOP344..
- TSOP343..
- TSOP341..
- TSOP44...
- TSOP48...
- TSOP41...
- TSOP324..
- TSOP323..
- TSOP322..
- TSOP321..
- TSOP24...
- TSOP22...
- TSOP21...
- TSOP345..
- TSOP325..
- TSOP43...
- TSOP23...
- TSSP4..
- TSMP4..

LOOSE PACKED IN TUBE

ORDERING INFORMATION



O = for IR receiver applications
M = for repeater/learning applications
S = for sensor applications

Note

- d = "digit", please consult the list of available devices create a valid part number.

Example: TSOP4838

PACKAGING QUANTITY

- 90 pieces per tube
- 24 tubes per carton

PACKAGING DIMENSIONS in millimeters



Drawing-No.: 9.700-5185.0-4
Rev. 13; Date: 20.11.03
20273-1

Druck / Printing for tubes
1.400-5548.0-3 Version 1



TAPE AND REEL/AMMOPACK

Up to 3 consecutive components may be missing if the gap is followed by at least 6 components. A maximum of 0.5 % of the components per reel quantity may be missing. At least 5 empty positions are present at the start and the end of the tape to enable insertion.

Tensile strength of the tape: > 15 N

Pulling force in the plane of the tape, at right angles to the reel: > 5 N



80079 tape on reel-s



80079 ammpack-s

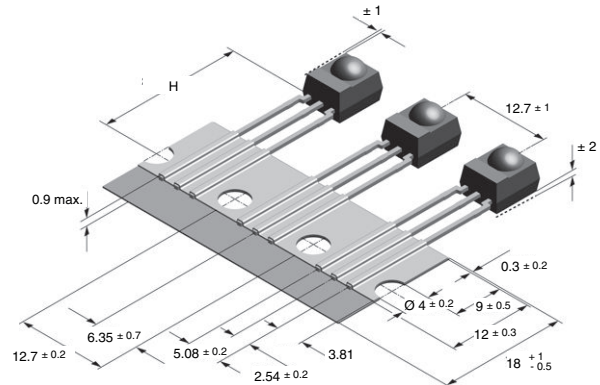

VERSION	DIMENSION "H"
BS	20 ± 0.5
PS	23.3 ± 0.5
OS	26 ± 0.5

ORDERING INFORMATION

T S d P

O = for IR receiver applications
 M = for repeater/learning applications
 S = for sensor applications

d d d d d

2 or 3 digit product series 2 digit frequency

S S 1

SS1 for T and R, bulk or ammpack

d d d d

dd = BS, PS or OS Tape and reel dd = 12 or 21

Z

Ammpack

Note

- d = "digit", please consult the list of available devices create a valid part number.

Example: TSOP4838SS1BS12

TSOP2238SS1BS12Z

PACKAGING QUANTITY

- 1000 pieces per reel
- 1000 pieces per ammpack



BULK PACKAGING

The option "BK" signifies bulk packaging in conductive plastic bags. A maximum of 0.3 % of the components per box may be missing.

ORDERING INFORMATION



Note

- d = "digit", please consult the list of available devices create a valid part number.

EXAMPLE: TSOP4838SS1BK
TSOP2238SS1BK

PACKAGING QUANTITY

- 250 pieces per bag (each bag is individually boxed)
- 6 bags per carton

OUTER PACKAGING

CARTON BOX DIMENSIONS in millimeters			
KINDS OF CARTON BOX	THICKNESS	WIDTH	LENGTH
Packaging Plastic Tubes (Normal/auxiliary devices)	80	150	600
Packaging Plastic Trays (Devices with metal holders)	120	290	490
Tape and Reel Box (Taping in reels)	400	310	410
Ammo-Box (Zigzag taping)	50	130	350



Disclaimer

ALL PRODUCT, PRODUCT SPECIFICATIONS AND DATA ARE SUBJECT TO CHANGE WITHOUT NOTICE TO IMPROVE RELIABILITY, FUNCTION OR DESIGN OR OTHERWISE.

Vishay Intertechnology, Inc., its affiliates, agents, and employees, and all persons acting on its or their behalf (collectively, "Vishay"), disclaim any and all liability for any errors, inaccuracies or incompleteness contained in any datasheet or in any other disclosure relating to any product.

Vishay makes no warranty, representation or guarantee regarding the suitability of the products for any particular purpose or the continuing production of any product. To the maximum extent permitted by applicable law, Vishay disclaims (i) any and all liability arising out of the application or use of any product, (ii) any and all liability, including without limitation special, consequential or incidental damages, and (iii) any and all implied warranties, including warranties of fitness for particular purpose, non-infringement and merchantability.

Statements regarding the suitability of products for certain types of applications are based on Vishay's knowledge of typical requirements that are often placed on Vishay products in generic applications. Such statements are not binding statements about the suitability of products for a particular application. It is the customer's responsibility to validate that a particular product with the properties described in the product specification is suitable for use in a particular application. Parameters provided in datasheets and/or specifications may vary in different applications and performance may vary over time. All operating parameters, including typical parameters, must be validated for each customer application by the customer's technical experts. Product specifications do not expand or otherwise modify Vishay's terms and conditions of purchase, including but not limited to the warranty expressed therein.

Except as expressly indicated in writing, Vishay products are not designed for use in medical, life-saving, or life-sustaining applications or for any other application in which the failure of the Vishay product could result in personal injury or death. Customers using or selling Vishay products not expressly indicated for use in such applications do so at their own risk. Please contact authorized Vishay personnel to obtain written terms and conditions regarding products designed for such applications.

No license, express or implied, by estoppel or otherwise, to any intellectual property rights is granted by this document or by any conduct of Vishay. Product names and markings noted herein may be trademarks of their respective owners.

Material Category Policy

Vishay Intertechnology, Inc. hereby certifies that all its products that are identified as RoHS-Compliant fulfill the definitions and restrictions defined under Directive 2011/65/EU of The European Parliament and of the Council of June 8, 2011 on the restriction of the use of certain hazardous substances in electrical and electronic equipment (EEE) - recast, unless otherwise specified as non-compliant.

Please note that some Vishay documentation may still make reference to RoHS Directive 2002/95/EC. We confirm that all the products identified as being compliant to Directive 2002/95/EC conform to Directive 2011/65/EU.

Vishay Intertechnology, Inc. hereby certifies that all its products that are identified as Halogen-Free follow Halogen-Free requirements as per JEDEC JS709A standards. Please note that some Vishay documentation may still make reference to the IEC 61249-2-21 definition. We confirm that all the products identified as being compliant to IEC 61249-2-21 conform to JEDEC JS709A standards.



Компания «ЭлектроПласт» предлагает заключение долгосрочных отношений при поставках импортных электронных компонентов на взаимовыгодных условиях!

Наши преимущества:

- Оперативные поставки широкого спектра электронных компонентов отечественного и импортного производства напрямую от производителей и с крупнейших мировых складов;
- Поставка более 17-ти миллионов наименований электронных компонентов;
- Поставка сложных, дефицитных, либо снятых с производства позиций;
- Оперативные сроки поставки под заказ (от 5 рабочих дней);
- Экспресс доставка в любую точку России;
- Техническая поддержка проекта, помощь в подборе аналогов, поставка прототипов;
- Система менеджмента качества сертифицирована по Международному стандарту ISO 9001;
- Лицензия ФСБ на осуществление работ с использованием сведений, составляющих государственную тайну;
- Поставка специализированных компонентов (Xilinx, Altera, Analog Devices, Intersil, Interpoint, Microsemi, Aeroflex, Peregrine, Syfer, Eurofarad, Texas Instrument, Miteq, Cobham, E2V, MA-COM, Hittite, Mini-Circuits, General Dynamics и др.);

Помимо этого, одним из направлений компании «ЭлектроПласт» является направление «Источники питания». Мы предлагаем Вам помощь Конструкторского отдела:

- Подбор оптимального решения, техническое обоснование при выборе компонента;
- Подбор аналогов;
- Консультации по применению компонента;
- Поставка образцов и прототипов;
- Техническая поддержка проекта;
- Защита от снятия компонента с производства.



Как с нами связаться

Телефон: 8 (812) 309 58 32 (многоканальный)

Факс: 8 (812) 320-02-42

Электронная почта: org@eplast1.ru

Адрес: 198099, г. Санкт-Петербург, ул. Калинина, дом 2, корпус 4, литера А.