

MMBTA42L, SMMBTA42L, MMBTA43L

High Voltage Transistors

NPN Silicon

Features

- AEC-Q101 Qualified and PPAP Capable
- S Prefix for Automotive and Other Applications Requiring Unique Site and Control Change Requirements
- These Devices are Pb-Free, Halogen Free/BFR Free and are RoHS Compliant

MAXIMUM RATINGS

Characteristic	Symbol	Value	Unit
Collector - Emitter Voltage MMBTA42, SMMBTA42 MMBTA43	V_{CEO}	300 200	Vdc
Collector - Base Voltage MMBTA42, SMMBTA42 MMBTA43	V_{CBO}	300 200	Vdc
Emitter - Base Voltage MMBTA42, SMMBTA42 MMBTA43	V_{EBO}	6.0 6.0	Vdc
Collector Current - Continuous	I_C	500	mAdc

THERMAL CHARACTERISTICS

Characteristic	Symbol	Max	Unit
Total Device Dissipation FR-5 Board (Note 1) $T_A = 25^\circ\text{C}$ Derate above 25°C	P_D	225 1.8	mW mW/ $^\circ\text{C}$
Thermal Resistance, Junction-to-Ambient	$R_{\theta JA}$	556	$^\circ\text{C}/\text{W}$
Total Device Dissipation Alumina Substrate (Note 2) $T_A = 25^\circ\text{C}$ Derate above 25°C	P_D	300 2.4	mW mW/ $^\circ\text{C}$
Thermal Resistance, Junction-to-Ambient	$R_{\theta JA}$	417	$^\circ\text{C}/\text{W}$
Junction and Storage Temperature	T_J, T_{stg}	-55 to +150	$^\circ\text{C}$

Stresses exceeding Maximum Ratings may damage the device. Maximum Ratings are stress ratings only. Functional operation above the Recommended Operating Conditions is not implied. Extended exposure to stresses above the Recommended Operating Conditions may affect device reliability.

1. FR-5 = 1.0 x 0.75 x 0.062 in.
2. Alumina = 0.4 x 0.3 x 0.024 in. 99.5% alumina.



ON Semiconductor®

<http://onsemi.com>

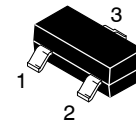
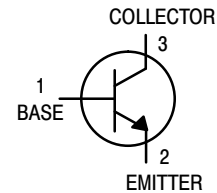

SOT-23 (TO-236)
CASE 318
STYLE 6

MARKING DIAGRAMS

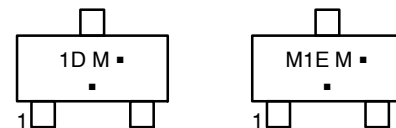

1D = MMBTA42LT, SMMBTA42L
M1E = MMBTA43LT
M = Date Code*
▪ = Pb-Free Package

(Note: Microdot may be in either location)
*Date Code orientation and/or overbar may vary depending upon manufacturing location.

ORDERING INFORMATION

See detailed ordering and shipping information in the package dimensions section on page 5 of this data sheet.

MMBTA42L, SMMBTA42L, MMBTA43L

ELECTRICAL CHARACTERISTICS ($T_A = 25^\circ\text{C}$ unless otherwise noted)

Characteristic		Symbol	Min	Max	Unit
OFF CHARACTERISTICS					
Collector – Emitter Breakdown Voltage (Note 3) ($I_C = 1.0\text{ mAdc}$, $I_B = 0$)	MMBTA42, SMMBTA42 MMBTA43	$V_{(BR)CEO}$	300 200	– –	Vdc
Collector – Base Breakdown Voltage ($I_C = 100\ \mu\text{Adc}$, $I_E = 0$)	MMBTA42, SMMBTA42 MMBTA43	$V_{(BR)CBO}$	300 200	– –	Vdc
Emitter – Base Breakdown Voltage ($I_E = 100\ \mu\text{Adc}$, $I_C = 0$)		$V_{(BR)EBO}$	6.0	–	Vdc
Collector Cutoff Current ($V_{CB} = 200\text{ Vdc}$, $I_E = 0$) ($V_{CB} = 160\text{ Vdc}$, $I_E = 0$)	MMBTA42, SMMBTA42 MMBTA43	I_{CBO}	– –	0.1 0.1	μAdc
Emitter Cutoff Current ($V_{EB} = 6.0\text{ Vdc}$, $I_C = 0$) ($V_{EB} = 4.0\text{ Vdc}$, $I_C = 0$)	MMBTA42, SMMBTA42 MMBTA43	I_{EBO}	– –	0.1 0.1	μAdc
ON CHARACTERISTICS (Note 3)					
DC Current Gain ($I_C = 1.0\text{ mAdc}$, $V_{CE} = 10\text{ Vdc}$) ($I_C = 10\text{ mAdc}$, $V_{CE} = 10\text{ Vdc}$) ($I_C = 30\text{ mAdc}$, $V_{CE} = 10\text{ Vdc}$)	Both Types Both Types MMBTA42, SMMBTA42 MMBTA43	h_{FE}	25 40 40 40	– – – –	–
Collector – Emitter Saturation Voltage ($I_C = 20\text{ mAdc}$, $I_B = 2.0\text{ mAdc}$)	MMBTA42, SMMBTA42 MMBTA43	$V_{CE(sat)}$	– –	0.5 0.5	Vdc
Base – Emitter Saturation Voltage ($I_C = 20\text{ mAdc}$, $I_B = 2.0\text{ mAdc}$)		$V_{BE(sat)}$	–	0.9	Vdc
SMALL-SIGNAL CHARACTERISTICS					
Current – Gain – Bandwidth Product ($I_C = 10\text{ mAdc}$, $V_{CE} = 20\text{ Vdc}$, $f = 100\text{ MHz}$)		f_T	50	–	MHz
Collector – Base Capacitance ($V_{CB} = 20\text{ Vdc}$, $I_E = 0$, $f = 1.0\text{ MHz}$)	MMBTA42, SMMBTA42 MMBTA43	C_{cb}	– –	3.0 4.0	pF

3. Pulse Test: Pulse Width $\leq 300\ \mu\text{s}$, Duty Cycle $\leq 2.0\%$.

MMBTA42L, SMMBTA42L, MMBTA43L

TYPICAL CHARACTERISTICS

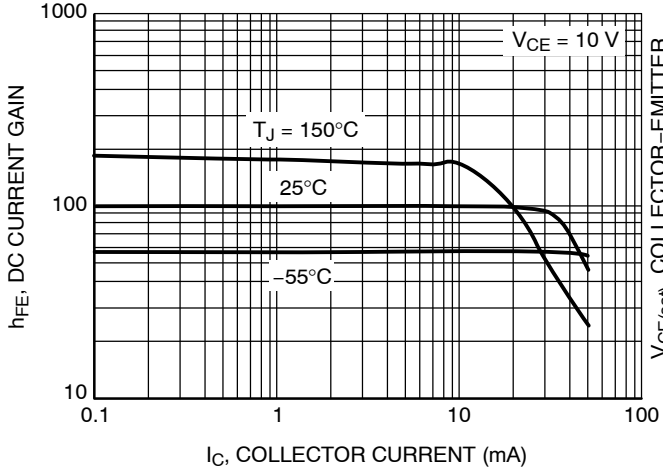

Figure 1. DC Current Gain

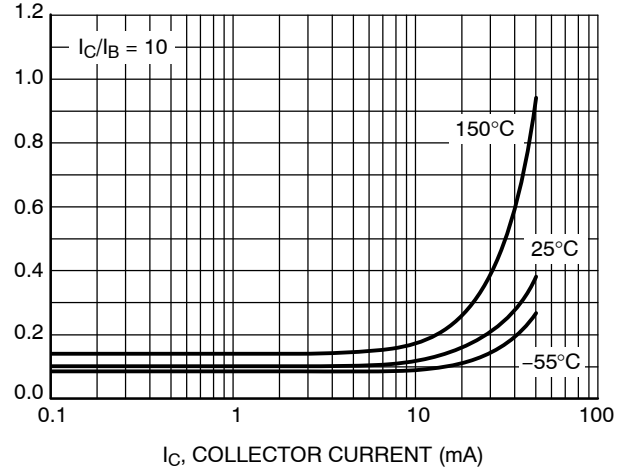

Figure 2. Collector-Emitter Saturation Voltage vs. Collector Current

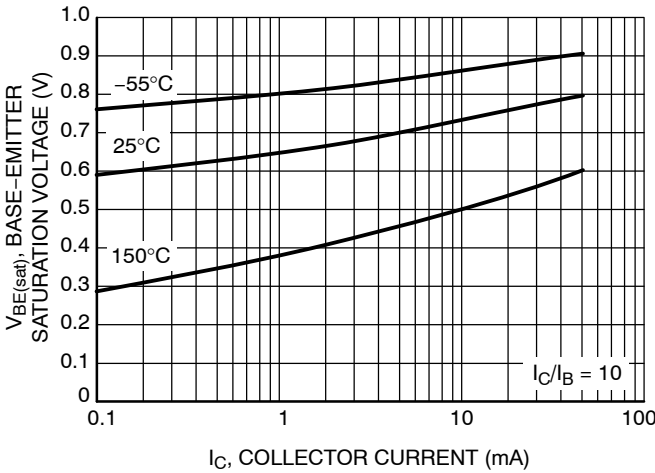

Figure 3. Base-Emitter Saturation Voltage vs. Collector Current

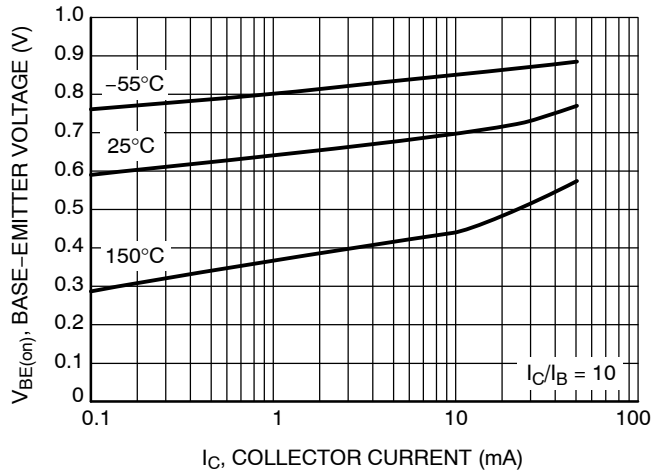

Figure 4. Base-Emitter On Voltage vs. Collector Current

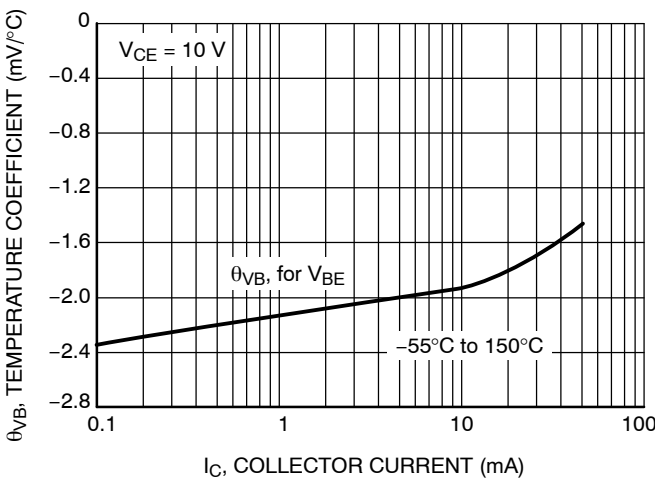

Figure 5. Base-Emitter Temperature Coefficient

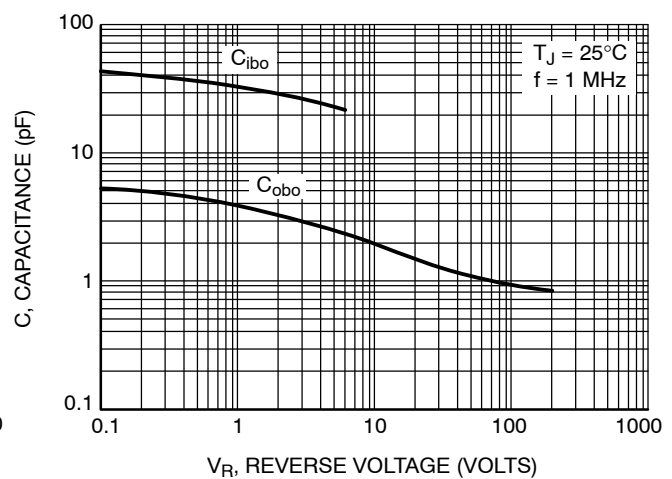

Figure 6. Capacitance

MMBTA42L, SMMBTA42L, MMBTA43L

TYPICAL CHARACTERISTICS

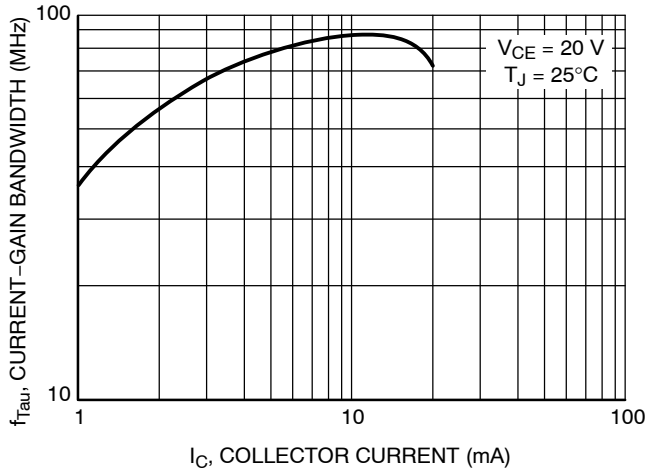

Figure 7. Current-Gain — Bandwidth Product

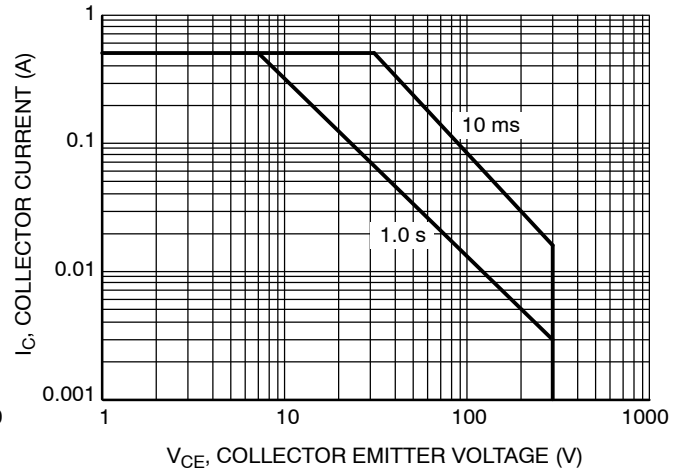

Figure 8. Safe Operating Area

MMBTA42L, SMMBTA42L, MMBTA43L

ORDERING INFORMATION

Device Order Number	Package Type	Shipping†
MMBTA42LT1G	SOT-23 (Pb-Free)	3,000 / Tape & Reel
SMMBTA42LT1G	SOT-23 (Pb-Free)	3,000 / Tape & Reel
MMBTA42LT3G	SOT-23 (Pb-Free)	10,000 / Tape & Reel
SMMBTA42LT3G	SOT-23 (Pb-Free)	10,000 / Tape & Reel
MMBTA43LT1G	SOT-23 (Pb-Free)	3,000 / Tape & Reel

†For information on tape and reel specifications, including part orientation and tape sizes, please refer to our Tape and Reel Packaging Specifications Brochure, BRD8011/D.

MMBTA42L, SMMBTA42L, MMBTA43L

PACKAGE DIMENSIONS

SOT-23 (TO-236)
CASE 318-08
ISSUE AP

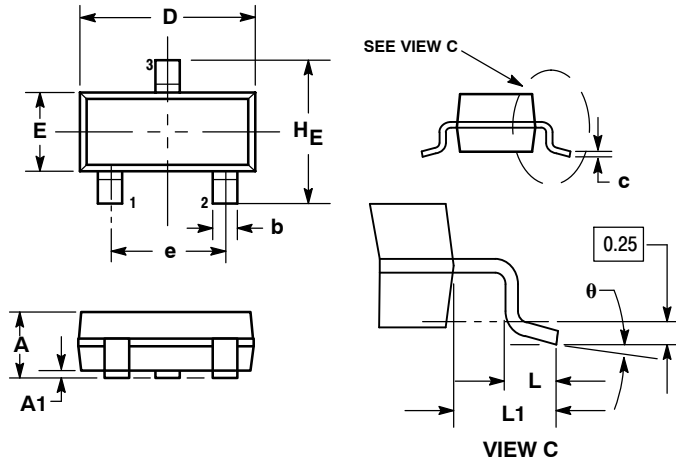

NOTES:

1. DIMENSIONING AND TOLERANCING PER ANSI Y14.5M, 1982.
2. CONTROLLING DIMENSION: INCH.
3. MAXIMUM LEAD THICKNESS INCLUDES LEAD FINISH THICKNESS. MINIMUM LEAD THICKNESS IS THE MINIMUM THICKNESS OF BASE MATERIAL.
4. DIMENSIONS D AND E DO NOT INCLUDE MOLD FLASH, PROTRUSIONS, OR GATE BURRS.

DIM	MILLIMETERS			INCHES		
	MIN	NOM	MAX	MIN	NOM	MAX
A	0.89	1.00	1.11	0.035	0.040	0.044
A1	0.01	0.06	0.10	0.001	0.002	0.004
b	0.37	0.44	0.50	0.015	0.018	0.020
c	0.09	0.13	0.18	0.003	0.005	0.007
D	2.80	2.90	3.04	0.110	0.114	0.120
E	1.20	1.30	1.40	0.047	0.051	0.055
e	1.78	1.90	2.04	0.070	0.075	0.081
L	0.10	0.20	0.30	0.004	0.008	0.012
L1	0.35	0.54	0.69	0.014	0.021	0.029
HE	2.10	2.40	2.64	0.083	0.094	0.104
θ	0°	---	10°	0°	---	10°

STYLE 6:

1. BASE
2. EMITTER
3. COLLECTOR

SOLDERING FOOTPRINT*

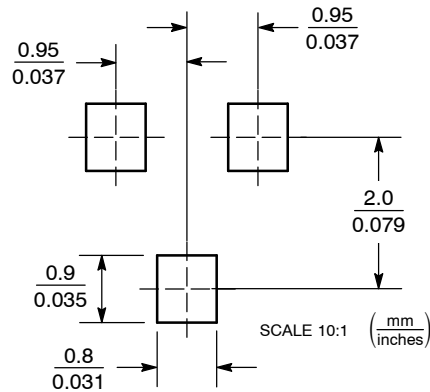

*For additional information on our Pb-Free strategy and soldering details, please download the ON Semiconductor Soldering and Mounting Techniques Reference Manual, SOLDERRM/D.

ON Semiconductor and are registered trademarks of Semiconductor Components Industries, LLC (SCILLC). SCILLC reserves the right to make changes without further notice to any products herein. SCILLC makes no warranty, representation or guarantee regarding the suitability of its products for any particular purpose, nor does SCILLC assume any liability arising out of the application or use of any product or circuit, and specifically disclaims any and all liability, including without limitation special, consequential or incidental damages. "Typical" parameters which may be provided in SCILLC data sheets and/or specifications can and do vary in different applications and actual performance may vary over time. All operating parameters, including "Typicals" must be validated for each customer application by customer's technical experts. SCILLC does not convey any license under its patent rights nor the rights of others. SCILLC products are not designed, intended, or authorized for use as components in systems intended for surgical implant into the body, or other applications intended to support or sustain life, or for any other application in which the failure of the SCILLC product could create a situation where personal injury or death may occur. Should Buyer purchase or use SCILLC products for any such unintended or unauthorized application, Buyer shall indemnify and hold SCILLC and its officers, employees, subsidiaries, affiliates, and distributors harmless against all claims, costs, damages, and expenses, and reasonable attorney fees arising out of, directly or indirectly, any claim of personal injury or death associated with such unintended or unauthorized use, even if such claim alleges that SCILLC was negligent regarding the design or manufacture of the part. SCILLC is an Equal Opportunity/Affirmative Action Employer. This literature is subject to all applicable copyright laws and is not for resale in any manner.

PUBLICATION ORDERING INFORMATION

LITERATURE FULFILLMENT:
Literature Distribution Center for ON Semiconductor
P.O. Box 5163, Denver, Colorado 80217 USA
Phone: 303-675-2175 or 800-344-3860 Toll Free USA/Canada
Fax: 303-675-2176 or 800-344-3867 Toll Free USA/Canada
Email: orderlit@onsemi.com

N. American Technical Support: 800-282-9855 Toll Free
USA/Canada
Europe, Middle East and Africa Technical Support:
Phone: 421 33 790 2910
Japan Customer Focus Center
Phone: 81-3-5817-1050

ON Semiconductor Website: www.onsemi.com
Order Literature: <http://www.onsemi.com/orderlit>

For additional information, please contact your local Sales Representative



Компания «ЭлектроПласт» предлагает заключение долгосрочных отношений при поставках импортных электронных компонентов на взаимовыгодных условиях!

Наши преимущества:

- Оперативные поставки широкого спектра электронных компонентов отечественного и импортного производства напрямую от производителей и с крупнейших мировых складов;
- Поставка более 17-ти миллионов наименований электронных компонентов;
- Поставка сложных, дефицитных, либо снятых с производства позиций;
- Оперативные сроки поставки под заказ (от 5 рабочих дней);
- Экспресс доставка в любую точку России;
- Техническая поддержка проекта, помощь в подборе аналогов, поставка прототипов;
- Система менеджмента качества сертифицирована по Международному стандарту ISO 9001;
- Лицензия ФСБ на осуществление работ с использованием сведений, составляющих государственную тайну;
- Поставка специализированных компонентов (Xilinx, Altera, Analog Devices, Intersil, Interpoint, Microsemi, Aeroflex, Peregrine, Syfer, Eurofarad, Texas Instrument, Miteq, Cobham, E2V, MA-COM, Hittite, Mini-Circuits, General Dynamics и др.);

Помимо этого, одним из направлений компании «ЭлектроПласт» является направление «Источники питания». Мы предлагаем Вам помощь Конструкторского отдела:

- Подбор оптимального решения, техническое обоснование при выборе компонента;
- Подбор аналогов;
- Консультации по применению компонента;
- Поставка образцов и прототипов;
- Техническая поддержка проекта;
- Защита от снятия компонента с производства.



Как с нами связаться

Телефон: 8 (812) 309 58 32 (многоканальный)

Факс: 8 (812) 320-02-42

Электронная почта: org@eplast1.ru

Адрес: 198099, г. Санкт-Петербург, ул. Калинина, дом 2, корпус 4, литера А.