

FEATURES

- Rugged Floating Topology
- Wide Operating Voltage Range: 9V to >500V
- Adjustable Output Clamp Voltage
- Controls N-Channel MOSFET
- Adjustable Protection Timer
- Internal 9-Second Cool-Down Timer
- Shutdown $I_Q < 14\mu\text{A}$
- 8-Lead TSOT and 3mm × 2mm DFN Packages

APPLICATIONS

- Industrial, Automotive and Avionic Surge Protection
- High Voltage DC Distribution
- 28V Vehicle Systems

DESCRIPTION

The **LTC[®]4366** surge stopper protects loads from high voltage transients. By controlling the gate of an external N-channel MOSFET, the LTC4366 regulates the output during an overvoltage transient. The load may remain operational while the overvoltage is dropped across the MOSFET. Placing a resistor in the return line isolates the LTC4366 and allows it to float up with the supply; therefore, the upper limit on the output voltage depends only on the availability of high valued resistors and MOSFET ratings.

An adjustable overvoltage timer prevents MOSFET damage during the surge while an additional 9-second timer provides for MOSFET cool down. A shutdown pin reduces the quiescent current to less than $14\mu\text{A}$ during shutdown. After a fault the LTC4366-1 latches off while the LTC4366-2 will auto-retry.

LT, LT, LTC, LTM, Linear Technology and the Linear logo are registered trademarks and ThinSOT is a trademark of Linear Technology Corporation. All other trademarks are the property of their respective owners. Patents pending.

TYPICAL APPLICATION

Overvoltage Protected 1.5A, 28V Supply



Overvoltage Protector Regulates Output at 43V During Transient



ABSOLUTE MAXIMUM RATINGS (Notes 1, 2) All voltages relative to V_{SS}, unless otherwise noted.

Supply Voltage (V _{DD})	-0.3V to 10V	CURRENTS	
Supply Voltage (OUT)	-0.3V to 5V	I _{VDD}	10mA
Input Voltages		I _{OUT}	10mA
FB	-0.3V to OUT + 0.3V	BASE	-300μA to 10μA
TIMER	-0.3V to 3.5V	SD	-10mA to 10μA
SD	-0.3V to 10V	Operating Ambient Temperature Range (Note 4)	
Output Voltages		LTC4366C	0°C to 70°C
BASE	-1.5V to 4V	LTC4366I	-40°C to 85°C
OUT – BASE	-0.3V to 5.5V	LTC4366H	-40°C to 125°C
GATE (Note 3)	-0.3V to 15V	LTC4366MP	-55°C to 125°C
GATE – OUT (Note 3)	-0.3V to 10V	Storage Temperature Range	-65°C to 150°C
		Lead Temperature (Soldering, 10 sec)	
		TSOT-23 Package Only	300°C

PIN CONFIGURATION

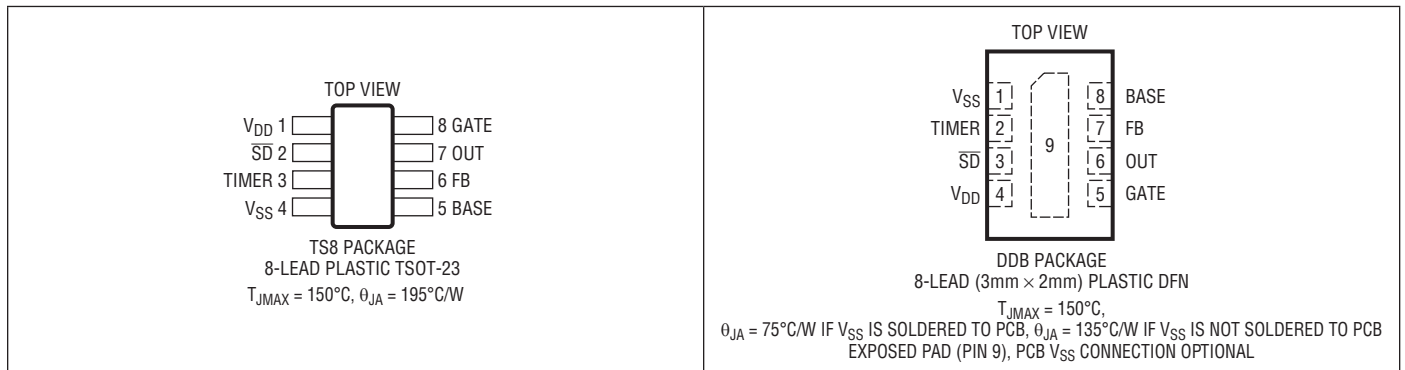

ORDER INFORMATION

Lead Free Finish

TAPE AND REEL (MINI)	TAPE AND REEL	PART MARKING*	PACKAGE DESCRIPTION	TEMPERATURE RANGE
LTC4366CTS8-1#TRMPBF	LTC4366CTS8-1#TRPBF	LTFMC	8-Lead Plastic TSOT-23	0°C to 70°C
LTC4366ITS8-1#TRMPBF	LTC4366ITS8-1#TRPBF	LTFMC	8-Lead Plastic TSOT-23	-40°C to 85°C
LTC4366HTS8-1#TRMPBF	LTC4366HTS8-1#TRPBF	LTFMC	8-Lead Plastic TSOT-23	-40°C to 125°C
LTC4366CDDB-1#TRMPBF	LTC4366CDDB-1#TRPBF	LFMD	8-Lead (3mm × 2mm) Plastic DFN	0°C to 70°C
LTC4366IDDB-1#TRMPBF	LTC4366IDDB-1#TRPBF	LFMD	8-Lead (3mm × 2mm) Plastic DFN	-40°C to 85°C
LTC4366HDDB-1#TRMPBF	LTC4366HDDB-1#TRPBF	LFMD	8-Lead (3mm × 2mm) Plastic DFN	-40°C to 125°C
LTC4366CTS8-2#TRMPBF	LTC4366CTS8-2#TRPBF	LTFMF	8-Lead Plastic TSOT-23	0°C to 70°C
LTC4366ITS8-2#TRMPBF	LTC4366ITS8-2#TRPBF	LTFMF	8-Lead Plastic TSOT-23	-40°C to 85°C
LTC4366HTS8-2#TRMPBF	LTC4366HTS8-2#TRPBF	LTFMF	8-Lead Plastic TSOT-23	-40°C to 125°C
LTC4366CDDB-2#TRMPBF	LTC4366CDDB-2#TRPBF	LFMG	8-Lead (3mm × 2mm) Plastic DFN	0°C to 70°C
LTC4366IDDB-2#TRMPBF	LTC4366IDDB-2#TRPBF	LFMG	8-Lead (3mm × 2mm) Plastic DFN	-40°C to 85°C
LTC4366HDDB-2#TRMPBF	LTC4366HDDB-2#TRPBF	LFMG	8-Lead (3mm × 2mm) Plastic DFN	-40°C to 125°C
LTC4366MPTS8-1#TRMPBF	LTC4366MPTS8-1#TRPBF	LTFMC	8-Lead Plastic TSOT-23	-55°C to 125°C
LTC4366MPTS8-2#TRMPBF	LTC4366MPTS8-2#TRPBF	LTFMF	8-Lead Plastic TSOT-23	-55°C to 125°C
LTC4366MPDDB-1#TRMPBF	LTC4366MPDDB-1#TRPBF	LFMD	8-Lead (3mm × 2mm) Plastic DFN	-55°C to 125°C
LTC4366MPDDB-2#TRMPBF	LTC4366MPDDB-2#TRPBF	LFMG	8-Lead (3mm × 2mm) Plastic DFN	-55°C to 125°C

TRM = 500 pieces. *Temperature grades are identified by a label on the shipping container.

Consult LTC Marketing for parts specified with wider operating temperature ranges.

Consult LTC Marketing for information on lead based finish parts.

For more information on lead free part marking, go to: <http://www.linear.com/leadfree/>

For more information on tape and reel specifications, go to: <http://www.linear.com/tapeandree/>

ELECTRICAL CHARACTERISTICS

The ● denotes the specifications which apply over the full operating temperature range, otherwise specifications are at $T_A = 25^\circ\text{C}$. All voltages relative to V_{SS} , unless otherwise noted.

SYMBOL	PARAMETER	CONDITIONS		MIN	TYP	MAX	UNITS
V_{DD} Regulator							
$V_{Z(VDD)}$	V_{DD} Shunt Regulator Voltage	$I = 1\text{mA}$	●	11.5	12	12.5	V
$\Delta V_{Z(VDD)}$	V_{DD} Shunt Regulator Load Regulation	$I = 1\text{mA}$ to 5mA	● ●		30 30	90 130	mV mV
V_{DD}	V_{DD} Supply Voltage (Note 3)		●	4.5		$V_{Z(VDD)}$	V
$I_{VDD(STLO)}$	V_{DD} Pin Current – Start-Up, Gate Low	$\text{GATE} = 0\text{V}$, $V_{DD} = 7\text{V}$, $\text{OUT} = 0\text{V}$	●		15	23	μA
$I_{VDD(STHI)}$	V_{DD} Pin Current – Start-Up, Gate High	GATE Open, $V_{DD} = 7\text{V}$, $\text{OUT} = 0\text{V}$	●		9	13	μA
$I_{VDD(SD)}$	V_{DD} Pin Current – Shutdown	$V_{DD} = 7\text{V}$, $\text{OUT} = 0\text{V}$	●		5	8	μA
OUT Regulator							
$V_{Z(OUT)}$	OUT Shunt Regulator Voltage	$I = 1\text{mA}$, $\text{BASE} = 0\text{V}$	●	5.0	5.7	6.0	V
$\Delta V_{Z(OUT)}$	OUT Shunt Regulator Load Regulation	$I = 1\text{mA}$ to 5mA	●		30	70	mV
OUT	OUT Supply Voltage (Note 3)		●	3.0		$V_{Z(OUT)}$	V
V_{UVL01}	OUT Undervoltage Lockout 1	Rising	● ●	2.42	2.55	2.75	V V
ΔV_{UVH1}	OUT Undervoltage Lockout 1 Hysteresis		●	0.2	0.28	0.4	V
V_{UVL02}	OUT Undervoltage Lockout 2	Rising	●	4.5	4.75	4.9	V
ΔV_{UVH2}	OUT Undervoltage Lockout 2 Hysteresis		●	0.3	0.4	0.5	V
$I_{OUT(AMP)}$	OUT Pin Current – Regulation Amplifier On		●		37	54	μA
$I_{OUT(CP)}$	OUT Pin Current – Charge Pump On		●		150	220	μA
$I_{OUT(SD)}$	OUT Pin Current – Shutdown		●		3	6	μA
BASE, V_{SS}							
$V_{Z(BASE)}$	BASE Shunt Regulator Voltage (OUT – BASE)	$I = -10\mu\text{A}$, $\text{OUT} = 4.5\text{V}$	●	5.5	6.2	6.6	V
$\Delta V_{Z(BASE)}$	BASE Shunt Regulator Load Regulation	$I = -10\mu\text{A}$ to $-80\mu\text{A}$, $\text{OUT} = 4.5\text{V}$	●		125	200	mV
I_{BASE}	BASE Pin Leakage Current	$\text{OUT} = 4.5\text{V}$, $\text{BASE} = -0.5\text{V}$	●	-0.1	-0.8	-5.5	μA
$I_{VSS(AMP)}$	V_{SS} Pin Current – Regulation Amplifier On		●	-30	-45	-72	μA
$I_{VSS(CP)}$	V_{SS} Pin Current – Charge Pump On		●	-108	-160	-230	μA
$I_{VSS(SD)}$	V_{SS} Pin Current – Shutdown		●		-7	-12	μA
GATE Drive							
ΔV_{GATE}	External N-Channel Gate Drive (GATE – OUT)	$\text{OUT} = 4.9\text{V}$, $I = 0$, $-1\mu\text{A}$	●	11.2	12	12.5	V
$I_{GATE(ST)}$	GATE Pin Current – Start-Up	$\text{GATE} = \text{OUT} = 0\text{V}$	● ●	-4.5 -3.2	-7.5 -7.5	-11 -11	μA μA
$I_{GATE(CP)}$	GATE Pin Current – Charge Pump On	$\text{GATE} = 5\text{V}$, $\text{OUT} = 4.9\text{V}$	●	-14	-20	-28	μA
$I_{GATE(FD)}$	GATE Pin Current – Fast Discharge	$\text{GATE} = 10\text{V}$, $\text{OUT} = 4.9\text{V}$	●	122	200	300	mA
$I_{GATE(FLT)}$	GATE Pin Current – Fault	$\text{GATE} = 10\text{V}$, $\text{OUT} = 4.9\text{V}$	●	0.3	0.7	1.2	mA

ELECTRICAL CHARACTERISTICS

The ● denotes the specifications which apply over the full operating temperature range, otherwise specifications are at $T_A = 25^\circ\text{C}$. All voltages relative to V_{SS} , unless otherwise noted.

SYMBOL	PARAMETER	CONDITIONS		MIN	TYP	MAX	UNITS	
FB, $\overline{\text{SD}}$, TIMER								
$V_{\text{FB(REG)}}$	3% FB pin Regulation Threshold (OUT – FB)		●	1.193	1.23	1.267	V	
I_{FB}	FB Pin Leakage Current	OUT – FB = 1.2V	●		0	±1	μA	
$V_{\overline{\text{SD}}(\text{TH})}$	$\overline{\text{SD}}$ Pin Threshold Voltage ($V_{\text{DD}} - \overline{\text{SD}}$)	Falling	●	1.0	1.5	2.3	V	
$V_{\overline{\text{SD}}(\text{HYST})}$	$\overline{\text{SD}}$ Pin Hysteresis	LTC4366C/I/H	●	147	280	530	mV	
			LTC4366MP	●	129	280	530	mV
$I_{\overline{\text{SD}}}$	$\overline{\text{SD}}$ Pin Input Pull-Up Current	$V_{\text{DD}} - \overline{\text{SD}} = 0.7\text{V}$	LTC4366C/I/H	●	-0.7	-1.6	-3.5	μA
			LTC4366MP	●	-0.5	-1.6	-3.5	μA
$V_{\text{TIMER(H)}}$	TIMER Pin Threshold	TIMER Rising, $V_{\text{DD}} = 7\text{V}$, OUT = $V_{\text{Z(OUT)}}$	●	2.6	2.8	3.1	V	
$I_{\text{TIMER(UP)}}$	TIMER Pin Pull-Up Current	TIMER = 1V	LTC4366C/I/H	●	-5.1	-9	-13	μA
			LTC4366MP	●	-4	-9	-13	μA
$I_{\text{TIMER(DN)}}$	TIMER Pin Pull-Down Current	TIMER = 1V	LTC4366C/I/H	●	0.9	1.8	2.8	μA
			LTC4366MP	●	0.7	1.8	2.8	μA
$I_{\text{TIMER(RATIO)}}$	TIMER Pin Current Ratio $I_{\text{TIMER(DN)}}/I_{\text{TIMER(UP)}}$		●	15	20	25	%	
AC Characteristics								
$t_{\text{DLY} - \overline{\text{SD}}}$	$\overline{\text{SD}}$ Low to Gate Low Filter Time	Step $V_{\text{DD}} - \overline{\text{SD}}$ from 0V to 3V	●	420	700	1200	μs	
$t_{\text{DLY} - \text{FAST}}$	FB Low to Gate Low Delay Time	Step OUT – FB from 0V to 1.3V	●	60	150	300	ns	
$t_{\text{D(COOL)}}$	Cool-Down Timer (Internal)	$V_{\text{DD}} = V_{\text{Z(VDD)}}$	LTC4366C/I/H	●	5.9	9	16	Seconds
			LTC4366MP	●	5.9	9	19	Seconds

Note 1: Stresses beyond those listed under Absolute Maximum Ratings may cause permanent damage to the device. Exposure to any Absolute Maximum Rating condition for extended periods may affect device reliability and lifetime.

Note 2: All currents into pins are positive.

Note 3: Limits on the maximum rating is defined as whichever limit occurs first. An internal clamp limits the GATE pin to a maximum of 12V above source. Driving this pin to voltages beyond the clamp may damage the device.

Note 4: T_J is calculated from the ambient temperature, T_A , and power dissipation, P_D , according to the formula:

$$T_J = T_A + (P_D \cdot \theta_{JA})$$

TYPICAL PERFORMANCE CHARACTERISTICS



TYPICAL PERFORMANCE CHARACTERISTICS

Gate Start-Up Current vs Temperature



Base Shunt Regulator vs Base Current

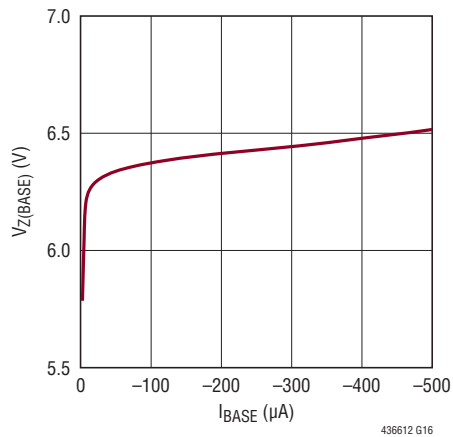

Timer Pull-Up Current vs Temperature

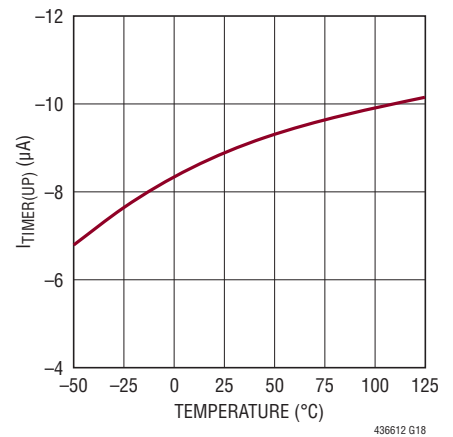

SD Pull-Up Current vs Temperature



FB Regulation Threshold vs Temperature

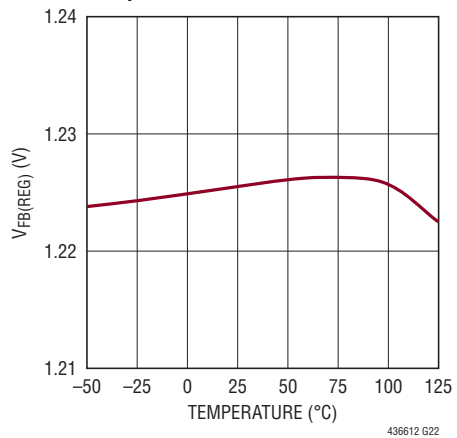

Cool-Down Time vs Temperature

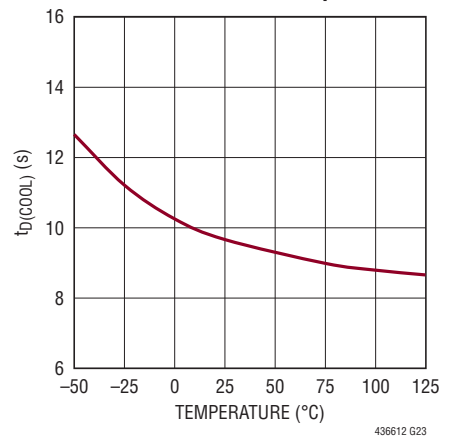

PIN FUNCTIONS

BASE: Base Driver Output for External PNP Shunt Regulator. This pin is connected to the anode of an internal 6.2V Zener with the cathode tied to OUT. In cases where lower Zener (Z3) clamp current is desired but a large V_{SS} resistor is prohibited, connect an external PNP base to this pin (PNP collector is grounded, emitter is tied to V_{SS}). Tie this pin to V_{SS} if unused.

Exposed Pad: The exposed pad may be left open or connected to V_{SS} .

FB: Overvoltage Regulation Amplifier Feedback Input. Connect this pin to an external resistive divider from OUT to ground. The overvoltage regulation amplifier controls the gate of the external N-channel MOSFET to regulate the FB pin voltage at 1.23V below OUT. The overvoltage amplifier will activate a 200mA pull-down on the GATE pin during a fast overvoltage event.

GATE: Gate Drive for External N-Channel MOSFET. During start-up an internal 7.5 μ A current source charges the gate of the external N-channel MOSFET from the V_{DD} pin. Once the OUT voltage is above V_{SS} by 4.75V, the charge pump will finish charging the GATE to 12V above OUT. During a fast overvoltage event, a 200mA pull-down current source between GATE and OUT is activated, followed by regulation of the GATE pin voltage by the overvoltage regulation amplifier.

OUT: Charge Pump and Overvoltage Regulation Amplifier Supply Voltage. Supply input for floating circuitry powered from the MOSFET source. Once the OUT voltage is 4.75V (UVLO2) above V_{SS} , the charge pump will turn on and draw power from this pin. When OUT exceeds 2.55V (UVLO1) it is used as a power supply and reference input for overvoltage regulation amplifier. This pin is clamped at 5.7V and requires a 0.22 μ F or greater bypass to the V_{SS} pin.

\overline{SD} : Shutdown Comparator Input. Tie to V_{DD} if unused. Connect pin to a limited current pull down created by adding a resistor in series with an open-drain or open-collector pull-down transistor. Activating the external pull down overcomes the internal 1.6 μ A pull-up current source and allows the \overline{SD} pin to cross the shutdown threshold. This threshold is defined as 1.5V below V_{DD} with a 280mV hysteresis. To prevent false triggers this pin must stay below the threshold for 700 μ s to activate the shutdown state. The shutdown state lowers the total quiescent current (I_{VDD} plus I_{OUT}) below 20 μ A. This quiescent current does not include shunt current in the V_{DD} , OUT and BASE regulators. After a fault on the LTC4366, putting the part in shutdown will clear the fault and allow operation to resume. Clearing the fault during the 9-second cool-down period will shorten the timeout for the LTC4366-2 (auto-retry) version.

TIMER: Timer Input. Leave this pin open for a 1 μ s overvoltage regulation period before fault off. Connect a capacitor between this pin and V_{SS} to set a 311ms/ μ F duration for overvoltage regulation before the switch is turned off. The LTC4366-2 version will restart after a nine second cool-down period.

V_{DD} : Start-Up Supply. Supply input for 7.5 μ A start-up current source that charges the gate of the external N-channel MOSFET. Also provides supply for timer and logic circuits active when the external MOSFET is off. This pin is clamped at 12V above V_{SS} . Do not bypass this pin with a capacitor.

V_{SS} : Device Return and Substrate. The capacitors on the TIMER and OUT pins should be returned to this pin.

SIMPLIFIED DIAGRAM



FUNCTIONAL DIAGRAM



OPERATION

The Simplified Diagram shows three states of operation: the start, run and regulate mode. Previous surge stopper parts are powered off the input supply, therefore the surge voltage is limited to the breakdown voltage of the input pins of the part. As demonstrated in run and regulate modes, the majority of this part is powered off the output, so the MOSFET isolates the surge from the power pins of the part. This allows surge voltages up to the breakdown of the external MOSFET.

In the start mode a $15\mu\text{A}$ trickle current flows through R_{IN} , half is used to charge the gate with the other half used as bias current. As the GATE pin charges, the external MOSFET brings up the OUT pin. This leads to the run mode where the output is high enough to become a supply voltage for the charge pump. The charge pump is then used to fully charge the gate 12V above the source.

With the output voltage equal to the input voltage, it is necessary to protect the load from an input supply over-voltage. In the regulate mode, the overvoltage regulation amplifier is referenced to the output through a 1.23V reference. If the voltage drop across the upper feedback resistor, R_{FB1} , exceeds 1.23V the regulation amplifier pulls the gate down to regulate the R_{FB1} voltage back to 1.23V. Therefore, the output voltage is clamped by setting the proper ratio between R_{FB1} and R_{FB2} .

For example, if the output voltage is regulated at 100V then the voltage drop across the R_{FB2} is 98.77V. If the Zener Z3 is 5.7V then the voltage drop across R_{SS} is 94.3V. Therefore, when the output is at a high voltage, the majority of the voltage is dropped across the two resistors R_{FB2} and R_{SS} . This demonstrates how the LTC4366 floats up with the supply. The adjustable 3-terminal regulators, such as the LT[®]1085 and LM117, are also based on this idea.

The Functional Diagram shows the actual circuits. An external R_{IN} resistor on the V_{DD} pin powers up the 12V shunt regulator which then powers up logic supply, V_{CC} . After verifying that the shutdown input is not active, the GATE pin is charged with a $7.5\mu\text{A}$ current from V_{DD} . This is the start mode.

Once the OUT to V_{SS} voltage exceeds the 2.55V UVLO1 threshold, the overvoltage amplifier is enabled. Next, the UVLO2 threshold of 4.75V is crossed and the charge pump turns on. The charge pump charges the GATE pin with $20\mu\text{A}$ to its final value 12V above OUT (clamped by Z4). This allows the capacitor between OUT and V_{SS} to charge until clamped by Z3 to 5.7V. In this run mode the MOSFET is configured as a low resistance pass transistor with little voltage drop and power dissipation in the MOSFET.

The powered up LTC4366 is now ready to protect the load against an overvoltage transient. The overvoltage regulation amplifier monitors the load voltage between OUT and ground by sensing the voltage on the FB pin with respect to the OUT pin (drop across R_{FB1}). In an overvoltage condition the OUT rises until the amplifier drives the M1 gate to regulate and limit the output voltage. This is the regulate mode.

During regulation the excess voltage is dropped across the MOSFET. To prevent overheating the MOSFET, the LTC4366 limits the overvoltage regulation time using the TIMER pin. The TIMER pin is charged with $9\mu\text{A}$ until the pin exceeds 2.8V. At that point an overvoltage fault is set, the MOSFET is turned off, and the part enters a cool-down period of 9 seconds. The logic and timer block are active during cool down while the GATE pin is pulled to OUT.

The latched-off version, LTC4366-1, will remain in fault until the \overline{SD} pin is toggled low and then high. Once the fault is cleared, the GATE is permitted to turn the MOSFET on again. The auto-retry version, LTC4366-2, waits 9 seconds then clears the fault and restarts.

APPLICATIONS INFORMATION

The typical LTC4366 application is a protected system that distributes power to loads safe from overvoltage transients. External component selection is discussed in the following sections.

Dual Shunt Regulators

The LTC4366 uses two shunt regulators coupled with the external voltage dropping resistors, R_{SS} and R_{IN} , to generate internal supply rails at the V_{DD} and OUT pins. These shunt-regulated rails allow overvoltage protection from unlimited high voltage transients irrespective of the voltage rating of the LTC4366's internal circuitry.

At the beginning of start-up, during shutdown, or after an overvoltage fault, the $GATE$ pin is clamped to the OUT pin thereby shutting off the MOSFET. This allows the V_{SS} and OUT pins to be pulled to ground by output load and R_{SS} . Under this condition the V_{DD} pin is clamped with a 12V shunt regulator to V_{SS} . The full supply voltage minus 12V is then impressed on the R_{IN} resistor which sets the shunt current. The shunt current can be as high as 10mA which is several orders of magnitude higher than the typical 9 μ A V_{DD} pin quiescent current.

In normal operation the OUT voltage is equal to the input supply. With $C1$ fully charged I_{C1} is zero at this point. Under this condition the voltage between the OUT and V_{SS} pins are clamped with a 5.7V shunt regulator. The input supply

voltage minus 5.7V is impressed on R_{SS} . The R_{SS} current is divided into three areas: the 5.7V shunt current, bias current between OUT and V_{SS} and finally the R_{IN} current. The 5.7V shunt current can be as high as 10mA which greatly exceeds the typical OUT (160 μ A) bias current.

Turn-On Sequence

The voltage between the V_{DD} and V_{SS} pins is shunt regulated to 12V after ramping up the input supply. Next, the internally generated supply, V_{CC} , produces a 30 μ s power-on-reset pulse which clears the fault latch and initializes internal latches. Next, the shutdown comparator determines if the \overline{SD} pin is externally pulled low, thereby requesting a low bias current shutdown state. Otherwise the external MOSFET, $M1$, is allowed to turn on.

Turning on the 7.5 μ A $GATE$ pull-up current source from the V_{DD} pin begins what can be described as a "bootstrapped" method for powering up the MOSFET gate. Once the $GATE$ reaches the V_{DD} pin voltage (minus a Schottky diode), the 7.5 μ A source loses voltage headroom and stops charging the $GATE$ (middle of waveforms in Figure 2.). The bootstrap method relies on charging $C1$ to a sufficient voltage after $GATE$ stops increasing. The voltage on $C1$ is then used as a supply for a charge pump that charges the gate to its final value 12V above OUT . $C1$ will discharge if the charge pump current exceeds the $C1$ charging current. If the voltage drops below 4.35V, the charge pump will pause allowing $C1$ to recharge.



Figure 1. Typical Application



Figure 2. Turn-On Waveforms

APPLICATIONS INFORMATION

Starting up with a supply voltage insufficient to charge C1 with large load current may result in overheating the MOSFET and subsequent damage. While the gate and output are ramping the drop across the MOSFET is the input supply minus the output. If the supply is lower than necessary to charge C1, then the output fails to ramp higher than the supply minus the threshold of the MOSFET. This 3V to 5V MOSFET drop with high load current will result in power dissipation without any protection or timeout limit.

Overvoltage Fault

The LTC4366 prevents an overvoltage on the input supply from reaching the load. Normally, the pass transistor is fully on, powering the load with very little voltage drop. As the input voltage increases the OUT voltage increases until it reaches the regulation point (V_{REG}). From that point any further voltage increase is dropped across the MOSFET. Note the MOSFET is still on so the LTC4366 allows uninterrupted operation during a short overvoltage event.

The V_{REG} point is configured with the two FB resistors, R_{FB1} and R_{FB2} . The regulation amplifier compares the FB pin to a threshold 1.23V below the OUT pin. During regulation the drop across R_{FB1} is 1.23V, while the remainder of the V_{REG} voltage is dropped across R_{FB2} .

When the output is at the regulation point a timer is started to prevent excessive power dissipation in the MOSFET. Normally the TIMER pin is held low with a 1.8 μ A pull-down current. During regulation the TIMER pin charges with 9 μ A. If the regulation point is held long enough for the TIMER pin to reach 2.8V then an overvoltage fault is latched. The equation for setting the timer capacitor is:

$$C_T = 3.2 \cdot t [nF / ms]$$

Depending on which version, the part will cool down and self start (LTC4366-2), or remain latched off until the \overline{SD} pin activates a shutdown followed by a start-up command (LTC4366-1). The cool-down time is typically nine seconds which provides a very low pulsed power duty cycle.

Starting up with an input supply overvoltage and full load current does increase the power dissipation in the MOSFET well beyond the case for an overvoltage surge. During the gate and output ramp up, the partial supply voltage (at full current) is dropped across the MOSFET. After start-up the normal overvoltage surge (with timeout) occurs before the shutting off the MOSFET. The Design Example section only considers the normal overvoltage surge for safe operating area (SOA) calculations for the MOSFET. Start-up into overvoltage will require additional SOA considerations.

Shutdown

The LTC4366 has a low current (<20 μ A) shutdown state that turns off the pass FET by tying the GATE and OUT pins together with a switched resistor. In the normal operating condition, the \overline{SD} pin is pulled up to the V_{DD} pin voltage with a 1.6 μ A current source. Tie the \overline{SD} pin to V_{DD} when the shutdown state is not used.

Bringing the \overline{SD} pin more than 1.5V below V_{DD} pin voltage for greater than the 700 μ s filter time activates the shutdown state. This filter time prevents unwanted activation of shutdown during transients. The \overline{SD} pin is diode clamped 0.7V below V_{SS} which requires current limiting (maximum 10mA) on the pull-down device. One way to limit the current is to connect an external 470k resistor in series with the open-collector pull-down device. Activating the external pull-down overcomes the internal 1.6 μ A pull-up current source and allows the \overline{SD} pin to cross the shutdown threshold.

APPLICATIONS INFORMATION

Following an overvoltage fault, putting the part in shutdown will clear the fault, allowing operation to resume once the LTC4366 leaves shutdown.

Output Short

A sudden short on the output can result in excessive current into the LTC4366 GATE pin supplied from the gate capacitor, C_G . The GATE pin is internally clamped to OUT with a 10V to 12V clamp. If the OUT pin is pulled low while the GATE pin is held up with C_G , then the clamp will be damaged trying to discharge C_G when clamp voltage is exceeded. One solution is to add a 1k R_S resistor in series with C_G with a bypass diode as shown in Figure 3. The diode allows the capacitor to function as a bypass for energy coming from the MOSFET drain to gate capacitor during a supply overvoltage.



Figure 3. Output Short Protection

Resistor Power Ratings

The proper rating for the R_{SS} resistor in Figure 1 must be considered. During an overvoltage event the OUT pin is at regulation voltage (V_{REG}), so the voltage across R_{SS} is V_{REG} minus 5.7V. A small minimum supply voltage reduces the value of R_{SS} . Therefore, large differences between minimum supply voltage and the regulation voltage may require a large power resistor for R_{SS} .

The full supply voltage minus 12V can appear across R_{IN} during the overvoltage cool-down period. Normally the value for R_{IN} is several times larger than R_{SS} which lowers the power and size requirements for this resistor.

External PNP

In some cases the power resistor for R_{SS} may be physically large. A large value R_{SS} (with lower power and size) may be used in conjunction with a PNP as shown in Figure 4. In addition to the 0.8 μ A sourced from the BASE pin, the base current from the PNP must flow through R_{SS} which will limit the maximum R_{SS} value. In some cases the minimum PNP Beta is as low as 35. The base current becomes 10 μ A when the V_{SS} current is 350 μ A. One can see this allows a 35 (Beta) times larger R_{SS} than the application without the PNP.



Figure 4. External PNP Option

Minimum Supply Start-Up

When designing for the minimum supply condition, it is important that R_{SS} and R_{IN} are chosen to provide enough current to sufficiently charge $C1$ to 4.75V. The parameters that determine the minimum supply voltage include: $C1$ voltage, MOSFET threshold voltage, a series Schottky diode voltage drop, resistance of R_{SS} and R_{IN} , current in the V_{DD}

APPLICATIONS INFORMATION

pin, and finally the current from the V_{SS} pin (see Figure 5).

$$V_{IN(MIN)} = (I_{VDD} \cdot R_{IN}) + V_D + V_{TH} + V_{C1} + (I_{VSS} \cdot R_{SS})$$

Using the Electrical Characteristics table for above parameters:

$$V_{C1} = V_{UVLO2} = 4.75V \text{ (UVLO2 threshold)}$$

$$I_{VDD} = I_{VDD(STHI)} = 9\mu A \text{ (} I_{VDD} \text{ start-up, gate high)}$$

$$I_{VSS} = I_{VSS(AMP)} = 45\mu A \text{ (} I_{VSS} \text{ w/regulation amp)}$$

$$V_D = 0.58V$$

$$V_{IN(MIN)} = (9\mu A \cdot R_{IN}) + 0.58V + V_{TH} + 4.75V + (45\mu A \cdot R_{SS})$$

When the MOSFET gate is fully enhanced, the OUT pin voltage is equal to the supply voltage. This places another constraint on the minimum supply voltage because the charge pump increases the V_{SS} current to $160\mu A$. The $C1$ voltage is assumed to be clamped at $5.7V$. These values are specified as $V_{Z(OUT)}$ and $I_{VSS(CP)}$ (charge pump on) in the table of Electrical Characteristics:

$$V_{IN(MIN)} = V_{Z(OUT)} + (I_{VSS(CP)} \cdot R_{SS})$$

or

$$V_{IN(MIN)} = 5.7V + (160\mu A \cdot R_{SS})$$

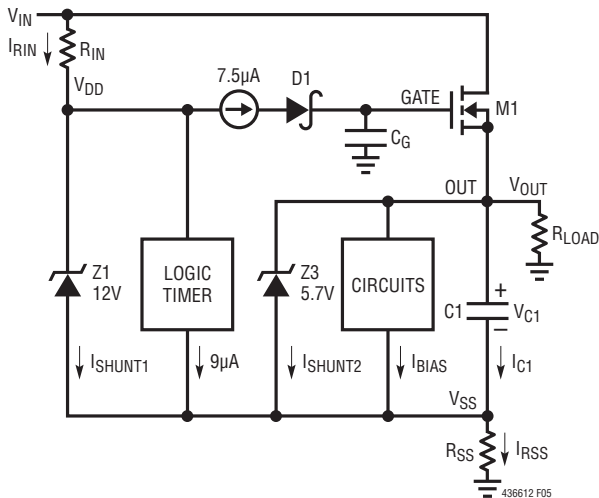

Figure 5. Simplified Block Diagram

The last $V_{IN(MIN)}$ equation sets the maximum value for R_{SS} . After choosing R_{SS} the maximum value for R_{IN} (for that particular R_{SS}) is calculated from the first $V_{IN(MIN)}$ equation:

$$R_{SS(MAX)} = \frac{V_{IN(MIN)} - 5.7V}{160\mu A}$$

$$R_{IN(MAX)} = \frac{V_{IN(MIN)} - 4.75V - 0.58V - V_{TH} - (45\mu A \cdot R_{SS})}{9\mu A}$$

These two equations maximize the values of R_{SS} and R_{IN} (reducing power dissipation) while still providing the necessary V_{C1} voltage to turn the charge pump on. Increasing the supply voltage beyond the minimum supply voltage increases the current and power in R_{SS} while reducing the time required to charge $C1$. Conditions that may require an even smaller $R_{SS(MAX)}$ will be discussed in the Maximum Supply Start-Up section.

Maximum Supply Start-Up

The maximum overvoltage supply may also exist during start-up. The overvoltage protection circuitry has to wake up before high voltage is passed to the load. Dynamically the GATE is ramping up while $C1$ is charging. Capacitor $C1$ must charge to the $2.55V$ UVLO1 threshold to turn on the regulation amplifier and reference before the OUT pin voltage exceeds the overvoltage regulation point, V_{REG} . These conditions may reduce the value of R_{SS} below the maximum value dictated by the minimum supply start-up discussed above.

When current in R_{SS} exceeds the current sourced from the V_{SS} pin (essentially I_{RIN}), the capacitor $C1$ begins to charge. The voltage at the V_{SS} pin when $I_{RIN} = I_{RSS}$ is now labeled $V_{SS(MATCH)}$. The V_{SS} pin voltage is the center of a voltage divider between R_{IN} and R_{SS} after the Zener clamp voltage from V_{DD} to V_{SS} is subtracted from the supply.

$$V_{SS(MATCH)} = \frac{R_{SS}}{R_{SS} + R_{IN}} \cdot (V_{IN(MAX)} - V_{Z(VDD)})$$

As V_{IN} increases the $V_{SS(MATCH)}$ voltage increases. If the match voltage exceeds the overvoltage regulation point (V_{REG}), then load is unprotected. This is true because $C1$ will still need to charge to $2.55V$ while V_{SS} already

APPLICATIONS INFORMATION

has exceeded V_{REG} . Since the OUT pin voltage is at least 2.55V larger than V_{SS} it exceeds the specified maximum. Choosing the match point (with supply at the maximum) sufficiently below V_{REG} (by at least 2.55V), allows C1 to charge up in time to protect the load from overvoltage. In reality having V_{SS} pin voltage 7V below V_{REG} provides required margin for charging C1.

$$V_{SS(MATCH)(MAX)} = V_{REG} - 7V$$

Increasing R_{SS} increases the match point, so determining the maximum R_{SS} value while still protecting from overvoltage is useful. Using $I_{RIN} = I_{RSS}$:

$$R_{SS} = R_{IN} \cdot \frac{V_{RSS}}{V_{RIN}}$$

Using:

$$V_{RSS} = V_{SS(MATCH)(MAX)} = V_{REG} - 7V$$

$$V_{RIN} = V_{IN} - V_{Z(VDD)} - V_{RSS}$$

Substituting:

$$R_{SS(MAX)} = \frac{R_{IN} \cdot (V_{REG} - 7V)}{V_{IN(MAX)} - 12V - (V_{REG} - 7V)}$$

$$R_{SS(MAX)} = \frac{R_{IN} \cdot (V_{REG} - 7V)}{V_{IN(MAX)} - 5V - V_{REG}}$$

If we guarantee that $R_{SS} < R_{SS(MAX)}$ then the following is true:

$$V_{SS(MATCH)} < V_{SS(MATCH)(MAX)}$$

C1 bypasses the charge pump, and requires at least a 0.22 μ F. The size of C1 needs limits also. The gate capacitor (C_G) dictates the maximum output capacitor $C1_{(MAX)}$ that will charge to the 2.55V UVLO1 threshold (V_{UVLO1}) before the OUT voltage exceeds the overvoltage threshold.

$$C1_{(MAX)} = \frac{-C_G \cdot (R_{SS} + R_{IN}) \cdot (V_{REG} - V_{SS(MATCH)})}{I_G \cdot R_{SS} \cdot R_{IN} \cdot \ln \left[1 - \frac{2 \cdot V_{UVLO1}}{V_{REG} - V_{SS(MATCH)}} \right]}$$

In most cases:

$$C1_{(MAX)} = 10 \cdot C_G \text{ to } 100 \cdot C_G$$

GATE Capacitor, C_G

The gate capacitor is used for three functions. First, C_G absorbs charge from the gate-to-drain capacitance of the MOSFET during overvoltage transients. Second, the capacitor also acts as a compensation element for the overvoltage regulation amplifier. The minimum value for C_G to guarantee stability is 2nF. Finally, C_G sets the slew rate of the GATE and OUT pins. The voltage at the GATE pin rises at a slope equal to $20\mu\text{A}/C_G$. This slope determines the charging current into the load capacitor.

$$I_{INRUSH} = \frac{C_{LOAD}}{C_G} \cdot I_G$$

The voltage rating for C_G must be greater than the regulation voltage (V_{REG}).

MOSFET Selection

The LTC4366 drives an N-channel MOSFET to conduct the load current. The important features of the MOSFET are on-resistance, $R_{DS(ON)}$, the maximum drain-source voltage, $V_{(BR)DSS}$, the threshold voltage, and the SOA.

The maximum allowable drain-source voltage must be higher than the supply voltage. If the output is shorted to ground or during an overvoltage event, the full supply voltage will appear across the MOSFET.

The threshold voltage of the MOSFET is used in the minimum supply start-up calculation. For applications with supplies less than 12V, a logic-level MOSFET is required. Above 12V a standard threshold N-channel MOSFET is sufficient.

The SOA of the MOSFET must encompass all fault conditions. In normal operation the pass transistor is fully on, dissipating very little power. But during overvoltage faults, the GATE pin is servoed to regulate the output voltage through the MOSFET. Large current and high voltage drop across the MOSFET can coexist in these cases. The SOA curves of the MOSFET must be considered carefully along with the selection of the fault timer capacitor.

APPLICATIONS INFORMATION

Layout Considerations

Due to the high impedances on the \overline{SD} , V_{DD} , and GATE pins, these pins are susceptible to leakages to ground. For example, a leakage to ground on \overline{SD} will activate the shutdown state if greater than $1.6\mu\text{A}$. Providing adequate spacing away from grounded traces and adding conformal coating on exposed pins lowers the risk that leakage current will interrupt system operation.

It is important to put the bypass capacitor, C1, as close as possible to the OUT and V_{SS} pins. Place the 10Ω resistor as close as possible to the MOSFET gate pin. This will limit the parasitic trace capacitance that leads to MOSFET self-oscillation.

The FB pin is sensitive to parasitic capacitance when the regulation loop is closed. One result from this capacitive loading is output oscillations during overvoltage regulation. It is suggested that the resistors R_{FB1} and R_{FB2} be placed close to the pin and that the FB trace itself be minimized in size.

DESIGN EXAMPLE

Overview

The design process starts with minimum input voltage start-up equations to calculate values for R_{SS} and R_{IN} . These values need further refinement to meet two other conditions: the maximum input voltage start-up conditions and proper current for the charging of C1. The remaining element values are calculated based on the input parameters.

Following are the input parameters for this example:

$$V_{\text{SUPPLY(MIN)}} = 18\text{V}, V_{\text{REG}} = 43\text{V}, V_{\text{IN(MAX)}} = 250\text{V}, I_{\text{LOAD}} = 1.5\text{A at start-up}, I_{\text{LOAD}} = 3\text{A after start-up}, V_{\text{TH}} = 5\text{V}$$

Important Electrical Characteristics table parameters used in this example are summarized in Table 1.

Step 1: Maximum R_{SS}

In this design example (Figure 6.) the component sizing first considers the start-up phase after the charge pump is active. The goal is to maximize the resistance of R_{SS} which still allows operation when the input voltage is at the minimum value.



Figure 6. Overvoltage Protected 28V, 1.5A Supply

APPLICATIONS INFORMATION

Table 1. Electrical Parameters Used in Design Example

SYMBOL	PARAMETER	CONDITIONS	TYP	MAX
V _{Z(OUT)}	OUT Shunt Reg. Voltage	I = 1mA, BASE = 0V	5.7V	6.0V
V _{UVL02}	OUT Undervoltage Lockout 2	Rising	4.75V	4.9V
I _{VSS(CP)}	V _{SS} Pin Current – Charge Pump On		-160μA	-230μA
I _{VSS(AMP)}	V _{SS} Pin Current – Regulation Amplifier On		-45μA	-72μA
I _{VDD(STH)}	V _{DD} Pin Current – Start-Up, Gate High	GATE Open, V _{DD} = 7V, OUT = 0V	9μA	13μA
I _{GATE(ST)}	GATE Pin Current – Start-Up	GATE = OUT = 0V	-7.5μA	-11μA
V _{UVL01}	OUT Undervoltage Lockout 1	Rising	2.55V	2.75V

After the charge pump is active the V_{SS} current increases to 160μA (worst-case 230μA, see Table 1) current while the final value OUT voltage is equal to the minimum supply voltage. The C1 voltage is clamped at 5.7V (worst-case 6.0V):

$$R_{SS(MAX)} = \frac{V_{IN(MIN)} - V_{Z(OUT)}}{I_{VSS(CP)}}$$

$$R_{SS(MAX)} = \frac{18V - 6V}{230\mu A} = 52.3k$$

Step 2: Determine R_{IN}

The value for resistor R_{IN} is calculated using the calculated R_{SS} value. R_{IN} is chosen to provide enough headroom to sufficiently charge C1 to 4.9V the maximum undervoltage lockout 2 threshold (V_{UVL02}) which starts the charge pump. The parameters that determine R_{IN} include: minimum supply voltage, the final C1 voltage, MOSFET threshold voltage, R_{SS}, 72μA maximum V_{SS} pin current (regulation amplifier on, I_{VSS(AMP)}), and finally the 13μA maximum start-up current in the V_{DD} pin (I_{VDD(STH)}):

$$R_{IN(MAX)} = \frac{V_{IN(MIN)} - V_{UVL02} - V_D - V_{TH} - (I_{SS(AMP)} \cdot R_{SS})}{I_{VDD(STH)}}$$

$$R_{IN(MAX)} = \frac{18V - 4.9V - 0.58V - 5V - (72\mu A \cdot 52.3k)}{13\mu A}$$

$$R_{IN(MAX)} = 287k$$

Step 3: Find R_{SS(MAX)}

In some cases this value for R_{SS} is too large to charge C1 and power the overvoltage amplifier before the maximum input voltage passes to the output. The voltage at the V_{SS} pin when I_{RIN} = I_{RSS} is called the match point (V_{SS(MATCH)}). Choosing the match point (with supply at the maximum) sufficiently below V_{REG} (by at least 7V), allows C1 to charge up in time to protect the load from overvoltage:

$$R_{SS(MAX)} = \frac{R_{IN} \cdot (V_{REG} - 7V)}{V_{IN(MAX)} - 5V - V_{REG}}$$

$$R_{SS(MAX)} = \frac{287k \cdot (43V - 7V)}{250V - 5V - 43V} = 51.1k$$

In this case the R_{SS} value of 52.3k calculated in Step 1 is too large.

Step 4: Iterate Smaller R_{SS}

Using 51.1k (R_{SS(MAX)}) as the next guess for R_{SS}, we can now calculate R_{IN} and R_{SS(MAX)}:

$$R_{IN} = \frac{18V - 4.9V - 0.58V - 5V - (72\mu A \cdot 51.1k)}{13\mu A}$$

$$R_{IN} = 294k$$

$$R_{SS(MAX)} = \frac{294k \cdot (43V - 7V)}{250V - 5V - 43V} = 52.3k$$

In this case the R_{SS} value of 51.1k is less than R_{SS(MAX)} and the solution is acceptable.

APPLICATIONS INFORMATION

Step 5: Determine C_G , $C1_{(MAX)}$, Check R_{SS}

The gate capacitor (C_G) determines the gate slew rate and therefore the slew rate of the OUT pin since the output voltage follows the GATE pin. The voltage at the GATE pin rises with a slope equal to $7.5\mu\text{A}/C_G$ at startup and $20\mu\text{A}/C_G$ when the charge pump is on. Limiting this slope will limit the inrush current charging the load capacitance where:

$$I_{INRUSH} = \frac{C_{LOAD}}{C_G} \cdot I_G$$

In this example we choose C_G to be 10nF which limits the inrush current to be 660mA for a $330\mu\text{F}$ C_{LOAD} .

$C1$ is used as a bypass capacitor for the circuitry between the OUT and V_{SS} pins. $C1$ also stabilizes the shunt regulator that clamps the voltage between these pins where the minimum value for regulator stability is $0.22\mu\text{F}$. An even greater $0.47\mu\text{F}$ value is desired for $C1$ to protect the OUT to V_{SS} circuitry from transients on the OUT pin.

The startup into an overvoltage creates an upper boundary on the value of $C1$. The value of C_G , R_{SS} and R_{VIN} determines a maximum $C1$ that will reach UVLO1 and power the regulation amplifier before the OUT pin voltage exceeds the overvoltage threshold. If our desired value for $C1$ ($0.47\mu\text{F}$) exceeds the maximum allowed $C1$ then a smaller R_{SS} must be used to iterate a new solution for $C1_{(MAX)}$. We start with calculating $V_{SS(MATCH)}$:

$$V_{SS(MATCH)} = \frac{R_{SS}}{R_{SS} + R_{VIN}} \cdot (V_{IN} - V_{Z(VDD)})$$

If we use the worst-case 1% maximum value for R_{SS} (51.6k) and minimum value for R_{VIN} (291k):

$$V_{SS(MATCH)} = 35.8\text{V}$$

$$C1_{(MAX)} = \frac{-C_G \cdot (R_{SS} + R_{IN})(V_{REG} - V_{SS(MATCH)})}{I_G \cdot R_{SS} \cdot R_{IN} \cdot \ln \left[1 - \frac{2 \cdot V_{UVLO1}}{V_{REG} - V_{SS(MATCH)}} \right]}$$

Use the worst-case maximum gate current of $11\mu\text{A}$ instead of the typical $7.5\mu\text{A}$ and the worst-case minimum UVLO1

threshold, 2.75V:

$$C1_{(MAX)} = \frac{-10\text{nF} \cdot (51.6\text{k} + 291\text{k})(43\text{V} - 35.8\text{V})}{11\mu\text{A} \cdot 51.6\text{k} \cdot 291\text{k} \cdot \ln \left[1 - \frac{2 \cdot 2.75\text{V}}{43\text{V} - 35.8\text{V}} \right]}$$

or

$$C1_{(MAX)} = 0.1\mu\text{F}$$

This limit on $C1$ does not meet the shunt regulator stability requirements ($C1 > 0.22\mu\text{F}$).

If we desire a larger value of $C1$ then a lower size of R_{SS} is required. A lower value for R_{SS} is 48.7k, which calls out an R_{IN} value of 309k and a max $C1$ value of $0.27\mu\text{F}$. The next lower value of 46.4k with R_{VIN} of 324k, results in the worst-case maximum $C1$ value of $0.49\mu\text{F}$. A larger $C1$ increases circuit immunity to transients in exchange for slightly higher current. Therefore, a selection of components that allow a $0.47\mu\text{F}$ $C1$ is recommended.

The lowered R_{SS} value of 46.4k now considers the tolerances of all the components that set the $C1$ ramp rate to guarantee it charges to the 2.55V UVLO1 threshold before the OUT voltage exceeds the overvoltage threshold.

Step 6: Determine R_{FB1} , R_{FB2}

The feedback resistors, R_{FB1} and R_{FB2} , are chosen to regulate the overvoltage at 43V. One way to quickly choose these resistors is to assign $100\mu\text{A}$ or 1.2V across a 12.4k R_{FB1} . R_{FB2} would need to drop the remainder of the regulated voltage. Dividing this remainder by $100\mu\text{A}$ yields the value for R_{FB2} . In this example R_{FB2} drops 41.8V. When divided by $100\mu\text{A}$ it results in a 422k value.

Step 7: Determine C_T , $R1$

During an overvoltage the power dissipated in the MOSFET is dependent on the load current and the difference between the supply and regulated voltages. It is necessary to keep the device power in a safe range. In the power MOSFET data sheets there is a maximum safe operating curve displaying current versus drain to source voltage for a fixed pulsed time. Other pulsed time data from DC to $10\mu\text{s}$ are plotted on the one graph. The different lines of operation generally follow a constant power squared

APPLICATIONS INFORMATION

times time or P^2t . Knowing the power we then adjust the time using the timer capacitor to limit the P^2t during overvoltage. In this example the MOSFET data sheet has a $6400W^2s$ P^2t for a 10ms single pulse.

In this application 250V minus 43V is applied across the MOSFET at 3A. If the power is applied for less than 16.5ms then MOSFET P^2t limit is not exceeded:

$$P = (250V - 43V) \cdot 3A = 621W$$

$$P^2t = (621W)^2 \cdot 16.5ms = 6363W^2s$$

Prior to the moment when the output is regulated at 43V, the output is ramping from 28V to 43V. This ramp time is based on the $20\mu A$ gate current charging the 10nF capacitor. Using the equation for ramp time:

$$\Delta t = \frac{C_G \cdot \Delta V}{I_G} = \frac{10nF \cdot 15V}{20\mu A} = 7.5ms$$

To be safe we set the overvoltage time to 10ms. We set the regulation time to be 2.5ms (the remainder of the 10ms overvoltage time minus the ramp time). In this example it is assumed the 250V overvoltage is a constant DC voltage for 10ms. This duration exceeds Mil-Std-1275 which specifies a $70\mu s$ surge to 250V that decays in 1.6ms. Using the following equation (based on charging with $9\mu A$) to set the C_T :

$$C_T = I_T \cdot \frac{\Delta t}{\Delta V} = 9\mu A \cdot \frac{2.5ms}{2.8V} \approx 8.2nF$$

In order to limit the \overline{SD} pin current (10mA max) a collector resistor, R1, in series with Q1 is required. The maximum value for this resistor is around 5M. This requirement occurs when the pull-down is required to sink $1.6\mu A$ from \overline{SD} and V_{DD} is clamped at 12V. High valued resistors are susceptible to leakage currents so we chose a 470k resistor for R1. Resistor R2 provides ESD protection for Q1's base.

The gate resistor R_G limits the parasitic trace capacitance on M1's gate node that could lead to parasitic MOSFET self-oscillation. The recommended value for R_G is 10Ω .

High Voltage Application

In Figure 7 the circuit accepts 110V AC (rectified to 160V) and protects the load from accidental connection to 220V AC by limiting the output to less than 200V. The circuit has a 100V to 800V V_{IN} operating range where the FET breakdown voltage limits the maximum input voltage. The C1 is set to $0.47\mu F$ to provide a bypass for the charge pump that is large enough to provide good noise immunity from outside voltage transients. The timer capacitor is sized to give a 1ms overvoltage regulation time that keeps the P^2t below the $640W^2s$ specified for this MOSFET.



Figure 7. Rectified 110V AC Supply Protected from 220V AC

APPLICATIONS INFORMATION

28V Vehicle Application

The circuit in Figure 8 adds reverse voltage protection to the standard 28V application shown in Figure 6. There are three modes to this circuit: pass FET On when the input is 18V to 41V, clamping the output to 43V when more than 43V appears at the input and finally reverse voltage protection when up to -250V DC is present at the input.

The reverse voltage protection consists of the circuitry inside the dotted box in Figure 8. When a positive voltage is first applied to the input, D3 and the forward biased base-collector junction of Q2 allow the gate of M2 to follow the input voltage minus a two diode drop. During this condition the body diode of M2 is used to transmit power to the LTC4366. Once the LTC4366 is powered up it fully enhances the gate of M1 and M2 (via D1). The M1 and M2 pass FETs then provide a low impedance path to the load. In an overvoltage condition, D1 blocks excessive positive voltage from the input supply passing to the GATE pin of the LTC4366. D4 eliminates current flow through R6 when the input is positive while D3 prevents emitter base breakdown of Q2 when the input is powering up.

During negative input voltages Q2 turns on when current from R6 (via D4) develops a forward diode drop on R5. Q2 then holds the gate of M2 at the input voltage which turns M2 off. This blocks negative input voltages from reaching M1 and the load. D2 prevents damage to the LTC4366's GATE pin by clamping it at ground when the M2's gate is negative.

Low Voltage Application

The circuit on the last page (Surge Protected Automotive Supply) starts up with minimum input voltage of 9V. In order to successfully start up at 9V and clamp the output voltage at 18V for input voltages up to 100V the value of R_{SS} has to be small (1.91k). The FET used in this case has a 3V threshold to ease the start-up requirements. The timer capacitor is sized to give a 2.5ms overvoltage regulation time that keeps the P^2t below the $420\text{W}^2\text{s}$ specified for this MOSFET.



Figure 8. 28V Vehicle Application with Reverse Voltage Protection

PACKAGE DESCRIPTION

Please refer to <http://www.linear.com/designtools/packaging/> for the most recent package drawings.

TS8 Package
8-Lead Plastic TSOT-23
 (Reference LTC DWG # 05-08-1637 Rev A)



NOTE:

1. DIMENSIONS ARE IN MILLIMETERS
2. DRAWING NOT TO SCALE
3. DIMENSIONS ARE INCLUSIVE OF PLATING
4. DIMENSIONS ARE EXCLUSIVE OF MOLD FLASH AND METAL BURR
5. MOLD FLASH SHALL NOT EXCEED 0.254mm
6. JEDEC PACKAGE REFERENCE IS MO-193

PACKAGE DESCRIPTION

Please refer to <http://www.linear.com/designtools/packaging/> for the most recent package drawings.

DDB Package 8-Lead Plastic DFN (3mm × 2mm) (Reference LTC DWG # 05-08-1702 Rev B)



RECOMMENDED SOLDER PAD PITCH AND DIMENSIONS

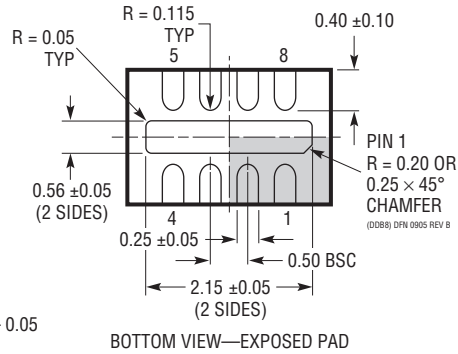
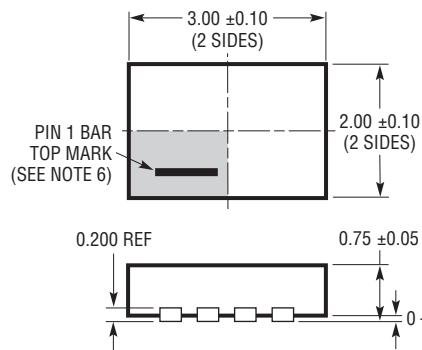

NOTE:

1. DRAWING CONFORMS TO VERSION (WECD-1) IN JEDEC PACKAGE OUTLINE M0-229
2. DRAWING NOT TO SCALE
3. ALL DIMENSIONS ARE IN MILLIMETERS
4. DIMENSIONS OF EXPOSED PAD ON BOTTOM OF PACKAGE DO NOT INCLUDE MOLD FLASH. MOLD FLASH, IF PRESENT, SHALL NOT EXCEED 0.15mm ON ANY SIDE
5. EXPOSED PAD SHALL BE SOLDER PLATED
6. SHADED AREA IS ONLY A REFERENCE FOR PIN 1 LOCATION ON THE TOP AND BOTTOM OF PACKAGE

REVISION HISTORY

REV	DATE	DESCRIPTION	PAGE NUMBER
A	1/12	Added Patents Pending statement	1
		Revised Figure 4 in Applications Information section	11
B	2/12	Removed reference to overcurrent faults under MOSFET Selection	13
		Fixed orientation of M2 in Figure 8	18
C	8/12	Updated Shutdown current from <math><20\mu\text{A}</math> to <math><14\mu\text{A}</math>	1
		Changed MOSFET part number and Gate Capacitor value used in the Typical Application	1
		Added MP-grade order information and specifications	2, 3, 4, 5
		Added negative sign to graphs G12 x-axis and G18, G21 y-axis	6, 7
		Changed MOSFET part number in Figure 1 and Figure 6	11, 16
		Added section GATE Capacitor, C_G	15
		Changed I_{LOAD} current from 5A to 3A in Design Example	16
		Updated $C1_{(MAX)}$ values in Step 5 calculations to 0.27 μF and worst case 0.49 μF	18
		Updated calculated values in Step 7, added supporting text	19
Changed MOSFET part number and GATE capacitor used in Figure 7	19		
D	8/13	Simplified Diagram: Corrected amplifier's input polarity in Regulate Diagram	9
		Functional Diagram: Added switch in series with TIMER pull-down current	9
E	8/15	Clarified "Ambient" on Operating Temperature Range; raised T_{JMAX} to 150°C	2
		TIMER Pin Function: Changed 278ms/ μF to 311ms/ μF	8
		Figures 1, 6, 8: Changed C_T to 8.2nF from 10nF	11, 16, 20
		In C_T equation, changed constant to 3.2 from 3.5; updated C_T calculation	12, 19

TYPICAL APPLICATION

Surge Protected Automotive 12V Supply



RELATED PARTS

PART NUMBER	DESCRIPTION	COMMENTS
LTC1696	Overvoltage Protection Controller	ThinSOT™ Package, 2.7V to 28V
LTC2909	Triple/Dual Inputs UV/OV Negative Monitor	Pin Selectable Input Polarity Allows Negative and OV Monitoring
LTC2912/LTC2913	Single/Dual UV/OV Voltage Monitor	Ads UV and OV Trip Values, ±1.5% Threshold Accuracy
LTC2914	Quad UV/OV Monitor	For Positive and Negative Supplies
LTC3827/LTC3827-1	Low IQ, Dual, Synchronous Controller	$4V \leq V_{IN} \leq 36V$, $0.8V \leq V_{OUT} \leq 10V$, 80μA Quiescent Current
LTC3835/LTC3835-1	Low IQ, Synchronous Step-Down Controller	Single Channel LTC3827/LTC3827-1
LT3845	Low IQ, Synchronous Step-Down Controller	$4V \leq V_{IN} \leq 60V$, $1.23V \leq V_{OUT} \leq 36V$, 120μA Quiescent Current
LTC3850	Dual, 550kHz, 2-Phase Synchronous Step-Down Controller	Dual 180° Phased Controllers, V_{IN} 4V to 24V, 97% Duty Cycle, 4mm × 4mm QFN-28, SSOP-28 Packages
LTC3890	Low IQ, Dual 2-Phase, Synchronous Step-Down Controller	$4V \leq V_{IN} \leq 60V$, $0.8V \leq V_{OUT} \leq 24V$, 50μA Quiescent Current
LT4256	Positive 48V Hot Swap Controller with Open-Circuit Detect	Foldback Current Limiting, Open-Circuit and Overcurrent Fault Output, Up to 80V Supply
LTC4260	Positive High Voltage Hot Swap Controller with 8-Bit ADC and I ² C	Wide Operating Range 8.5V to 80V
LTC4352	Ideal MOSFET ORing Diode	External N-Channel MOSFETs Replace ORing Diodes, 0V to 18V
LTC4354	Negative Voltage Diode-OR Controller	Controls Two N-Channel MOSFETs, 1.2μs Turn-Off, -80V Operation
LTC4355	Positive Voltage Diode-OR Controller	Controls Two N-Channel MOSFETs, 0.4μs Turn-Off, 80V Operation
LT4363	High Voltage Surge Stopper	100V Overvoltage and Overcurrent Protection, Latch-Off and Auto-Retry Options
LTC4365	Window Passer – OV, UV and Reverse Supply Protection Controller	2.5V to 34V Operation, Protects 60V to -40V



Компания «ЭлектроПласт» предлагает заключение долгосрочных отношений при поставках импортных электронных компонентов на взаимовыгодных условиях!

Наши преимущества:

- Оперативные поставки широкого спектра электронных компонентов отечественного и импортного производства напрямую от производителей и с крупнейших мировых складов;
- Поставка более 17-ти миллионов наименований электронных компонентов;
- Поставка сложных, дефицитных, либо снятых с производства позиций;
- Оперативные сроки поставки под заказ (от 5 рабочих дней);
- Экспресс доставка в любую точку России;
- Техническая поддержка проекта, помощь в подборе аналогов, поставка прототипов;
- Система менеджмента качества сертифицирована по Международному стандарту ISO 9001;
- Лицензия ФСБ на осуществление работ с использованием сведений, составляющих государственную тайну;
- Поставка специализированных компонентов (Xilinx, Altera, Analog Devices, Intersil, Interpoint, Microsemi, Aeroflex, Peregrine, Syfer, Eurofarad, Texas Instrument, Miteq, Cobham, E2V, MA-COM, Hittite, Mini-Circuits, General Dynamics и др.);

Помимо этого, одним из направлений компании «ЭлектроПласт» является направление «Источники питания». Мы предлагаем Вам помощь Конструкторского отдела:

- Подбор оптимального решения, техническое обоснование при выборе компонента;
- Подбор аналогов;
- Консультации по применению компонента;
- Поставка образцов и прототипов;
- Техническая поддержка проекта;
- Защита от снятия компонента с производства.



Как с нами связаться

Телефон: 8 (812) 309 58 32 (многоканальный)

Факс: 8 (812) 320-02-42

Электронная почта: org@eplast1.ru

Адрес: 198099, г. Санкт-Петербург, ул. Калинина, дом 2, корпус 4, литера А.