



Typical unit

FEATURES

- Small footprint DC/DC converter, ideal for high current applications
- Industry standard 0.96" x 1.1" X 0.35" open frame package and pinout
- Wide range input voltages 9-36 and 18-75 Vdc
- Bipolar $\pm 5V$, $\pm 12V$ and $\pm 15V$ outputs
- Up to 15 Watts or greater total output power with overtemperature shutdown
- Isolation up to 2250 VDC (basic), Q48 models
- High efficiency synchronous rectifier forward topology
- Usable -40 to 85°C temperature range (with derating)
- Assembly and attachment for RoHS standards
- Extensive self-protection shut down features
- Meets UL 60950-1, CAN/CSA-C22.2 No. 60950-1, IEC60950-1, EN60950-1 safety approvals (2nd Edition)

PRODUCT OVERVIEW

Featuring a full 15 Watt output in one square inch of board area, the BEI-15 series isolated DC/DC converter family offers efficient regulated DC power for printed circuit board mounting. The wide range 4:1 inputs on the 0.96" x 1.1" x 0.35" (24.4 x 27.9 x 8.9 mm) converter are either 9 to 36 Volts DC (Q12 models) or 18 to 75 Volts DC (Q48 models), ideal for battery-powered and telecom equipment. The industry-standard pinout fits larger 1" x 2" converters. Fixed output voltages of ± 5 , ± 12 or ± 15 VDC are regulated to within $\pm 0.25\%$. Applications include small instruments, area-limited microcontrollers, data communications equipment, remote sensor systems, vehicle and portable electronics.

The BEI-15 series includes full magnetic and optical isolation with Basic protection up to

2250 Volts DC (Q48 models) and 2000 VDC (Q12 models). For powering digital systems, the outputs offer fast settling to step transients and will accept higher capacitive loads. Excellent ripple and noise specifications assure compatibility to noise-susceptible circuits. For systems requiring controlled startup/shutdown, an external remote On/Off control may use a switch, transistor or digital logic.

A wealth of self-protection features avoid both converter and external circuit faults. These include input undervoltage lockout and overtemperature shutdown. The outputs current limit using the "hiccup" autorestart technique and the outputs are short-circuit protected. Additional features include output overvoltage and reverse conduction elimination. The high efficiency offers minimal heat buildup and "no fan" operation.

CONNECTION DIAGRAM



Typical topology is shown.

Murata Power Solutions recommends a fuse at F1.



| PERFORMANCE SPECIFICATIONS SUMMARY AND ORDERING GUIDE ① | | | | | | | | | | | | | | | | |
|---------------------------------------------------------|----------------------|------------------------------|-----------------|-------------|------|-------------------|--------|--------------------------|-----------|--------------------------------|----------------------------------|-------|--------------------------|---------------|---------------|-------------|
| Root Models ① | Output | | | | | | Input | | | | Efficiency | | Open Frame Package – C69 | | | |
| | V _{OUT} (V) | I _{OUT} (mA, max.)② | Total Power (W) | R/N (mVp-p) | | Regulation (Max.) | | V _{IN} Nom. (V) | Range (V) | I _{IN} = no load (mA) | I _{IN} = full load (mA) | Min. | Typ. | (inches) | (mm) | Case Pinout |
| | | | | Typ. | Max. | Line | Load | | | | | | | | | |
| BEI15-050-Q12 | ±5 | ±1500 | 15 | 60 | 100 | ±0.25% | ±0.25% | 24 | 9-36 | 90 | 740 | 82.8% | 84% | 0.96x1.1x0.35 | 24.4x27.9x8.9 | P74 |
| BEI15-050-Q48 | ±5 | ±1500 | 15 | 60 | 100 | ±0.25% | ±0.25% | 48 | 18-75 | 50 | 374 | 82% | 83.5% | | | |
| BEI15-120-Q12 | ±12 | ±625 | 15 | 80 | 120 | ±0.25% | ±0.25% | 24 | 9-36 | 95 | 730 | 82% | 86% | | | |
| BEI15-120-Q48 | ±12 | ±625 | 15 | 80 | 120 | ±0.25% | ±0.25% | 48 | 18-75 | 50 | 370 | 84% | 85.5% | | | |
| BEI15-150-Q12 | ±15 | ±500 | 15 | 100 | 150 | ±0.25% | ±0.25% | 24 | 9-36 | 100 | 740 | 83% | 84% | | | |
| BEI15-150-Q48 | ±15 | ±500 | 15 | 100 | 150 | ±0.25% | ±0.25% | 48 | 18-75 | 50 | 360 | 84.5% | 86% | | | |

- ① Please refer to the part number structure for additional options and complete ordering part numbers.
- ② The minimum output load for the BEI-15W series is 10% of maximum current to meet published specifications. The converter will not be damaged by less than 10% load but some specs may degrade slightly.
- ③ All specifications are at nominal line voltage and full load, +25 °C. unless otherwise noted. See detailed specifications and notes for full conditions.

- Output capacitors are 1 µF ceramic in parallel with 10 µF electrolytic. The input cap is 100 µF, low ESR.
- I/O caps are necessary for our test equipment and may not be needed for your application.
- ④ RoHS-6 compliance does not claim EU RoHS exemption 7b (lead in solder).

PART NUMBER STRUCTURE

BEI15 - 050 - Q12 P H Lx - C

- BEI15** - Bipolar Wide Input 15-Watt Series
- 050** - Nominal Output Voltage in Tenths of a Volt
- Q12** - Input Voltage Range
Q12 = 9-36V
Q48 = 18-75V
- P** - On/Off Control Logic
P = Positive
N = Negative
X = Control pin omitted ‡
- H** - Conformal Coating Option
Blank = No coating, standard
H = Coating added, optional (built to order; contact Murata Power Solutions for MOQ and lead times.)*
- Lx** - Pin Length Option
Blank = Std. pin length 0.25" (6.3mm)
L1 = 0.110" (2.79mm)*
L2 = 0.145" (3.68mm)*
- C** - RoHS-6 Hazardous Substance Compliance (note 4)

*Special quantity order is required; no sample quantities available.

‡Some model number combinations may not be available. Please contact Murata Power Solutions.

FUNCTIONAL SPECIFICATIONS

| INPUT CHARACTERISTICS | BEI15-050-Q12 | BEI15-050-Q48 | BEI15-120-Q12 | BEI15-120-Q48 | BEI15-150-Q12 | BEI15-150-Q48 |
|------------------------------------------|----------------------------------------------------------------------------|---------------|---------------|---------------|---------------|---------------|
| Input voltage range | See ordering guide | | | | | |
| Start-up threshold, Volts typ. | 9.0 | 17.0 | 9.5 | 17.0 | 8.9 | 17.0 |
| Undervoltage shutdown, Volts | 8.5 | 16.0 | 8.4 | 16.2 | 8.4 | 16.0 |
| Overvoltage shutdown, Volts | none | | | | | |
| Reflected (back) ripple current mA pk-pk | 5 | 30 | 30 | 30 | 5 | 30 |
| Input current | | | | | | |
| Full load conditions | See ordering guide | | | | | |
| Inrush transient, A2sec | 0.05 | 0.05 | 0.05 | 0.05 | 0.05 | 0.05 |
| Output short circuit, mA | 50 | 50 | 50 | 50 | 50 | 50 |
| Output at min. load, mA | 90 | 50 | 95 | 50 | 30 | 50 |
| Low line (Vin=min.), Amps | 2.03 | 1.0 | 2.01 | 0.97 | 1.97 | 0.96 |
| Standby mode, mA (Off, UV, OT shutdown) | 25 | 1 | 1 | 1 | 1 | 1 |
| Recommended fuse, Amps | 4 | 2 | 4 | 2 | 4 | 2 |
| Internal input filter type | Capacitive | | | | | |
| Reverse polarity protection | None, install external fuse | | | | | |
| Remote On/Off Control | | | | | | |
| Positive logic ("P" model suffix) | OFF=Gnd pin or -0.7 to +0.8V max. ON=open pin or +10 to +15V max. | | | | | |
| | | | | | | |
| | | | | | | |
| Negative logic ("N" model suffix) | OFF=open pin or +10 to +15V max. ON=Gnd pin or -0.7 to +0.8V max. | | | | | |
| | | | | | | |
| | | | | | | |
| On/Off Current, mA max. | 1 | | | | | |

| OUTPUT CHARACTERISTICS | BEI15-050-Q12 | BEI15-050-Q48 | BEI15-120-Q12 | BEI15-120-Q48 | BEI15-150-Q12 | BEI15-150-Q48 |
|----------------------------------------------------------------------------|--------------------------------------|---------------|---------------|---------------|---------------|---------------|
| Voltage output range | See ordering guide | | | | | |
| Voltage output accuracy, % of Vnom. (50% load) | ±1 | | | | | |
| Temperature coefficient, % of Vout range/°C | ±0.02 | | | | | |
| Minimum loading, percent of full power | 10 | | | | | |
| Ripple/noise (20 MHz bandwidth) | See ordering guide | | | | | |
| Line/Load regulation | | | | | | |
| Efficiency | | | | | | |
| Capacitive loading, µF max., low ESR <0.02Ω max., resistive load | 500 | 500 | 150 | 150 | 100 | 100 |
| Overvoltage protection, Volts (hiccup auto restart after fault removal) | 6.5 | 7 | 15.8 | 16 | 18 | 20 |
| OV protection method | Magnetic feedback | | | | | |
| Isolation voltage | | | | | | |
| Input to Output, Volts DC min. | 2000 | 2250 | 2000 | 2250 | 2000 | 2250 |
| Isolation resistance, MΩ min. | 10 | 10 | 10 | 10 | 10 | 10 |
| Isolation capacitance, pF | 1000 | 1000 | 600 | 700 | 1000 | 1000 |
| Isolation safety rating | Basic insulation | | | | | |
| Miscellaneous | | | | | | |
| Current limit inception, Amps (Vout actual ≤ 98% of Vnom.) after warmup | 2.6 | 2.5 | 1 | 1.1 | 0.9 | 0.9 |
| Short circuit protection method | Current limiting, hiccup autorestart | | | | | |
| Short circuit current, Amps max. | 0.3 | | | | | |
| Short circuit duration (output shorted to ground)① | Continuous | | | | | |

| DYNAMIC CHARACTERISTICS | BEI15-050-Q12 | BEI15-050-Q48 | BEI15-120-Q12 | BEI15-120-Q48 | BEI15-150-Q12 | BEI15-150-Q48 |
|------------------------------------------------------------------------------------|----------------------------------------------------------|---------------|---------------|---------------|---------------|---------------|
| Start-up time, mS, max. | 50 | 50 | 50 | 50 | 50 | 50 |
| Vin to Vout regulated, mS, max. (Remote On/Off to Vout regulated) | 50 | 50 | 50 | 60 | 50 | 50 |
| Dynamic Load Response (50-75-50% load step) | | | | | | |
| Settling time | 250µSec | 250µSec | 250µSec | 250µSec | 250µSec | 250µSec |
| Peak deviation | ±100mV | ±100mV | ±150mV | ±150mV | ±200mV | ±200mV |
| Switching frequency, KHz | 350 | 305 | 300 | 320 | 330 | 320 |
| Calculated MTBF, hours | >2000000 | | | | | |
| Operating temperature range | | | | | | |
| (Ambient, natural convection, with derating, vertical mount). See Derating graphs. | -40 to +85°C | | | | | |
| No derating | -40 to +70°C | | | | | |
| Storage temperature range | -55 to +125°C | | | | | |
| Thermal protection/shutdown, °C (measured at PWM) | 130 | | | | | |
| Relative humidity, non-condensing | To +85°C/85% | | | | | |
| PHYSICAL CHARACTERISTICS | | | | | | |
| Outline dimensions | See mechanical specs | | | | | |
| Pin material | Copper alloy | | | | | |
| Pin diameter | 0.040 inches 1.016 mm | | | | | |
| Pin Finish | Gold plate over nickel underplate | | | | | |
| Weight, ounces (grams) | 0.352 (10) | 0.352 (10) | 0.352 (10) | 0.352 (10) | 0.32 (9.07) | 0.32 (9.07) |
| Electromagnetic interference (requires external filter) | Meets EN55022 and CISPR22 with external filter | | | | | |
| Flammability rating | UL 94V-0 | | | | | |
| Safety (designed to meet) | UL/cUL 60950-1 CSA-C22.2 No.60950-1 IEC/EN 60950-1 | | | | | |

| ABSOLUTE MAXIMUM RATINGS | |
|----------------------------------------------------|-----------------------------|
| Input Voltage | |
| Q12 models | |
| Volts, max., continuous | 36 |
| Volts, transient 100 mS | 50 |
| Q48 models | |
| Volts, max., continuous | 75 |
| Volts, transient 100 mS | 100 |
| On/Off Control, referred to -Vin | |
| Volts, min. | -0.3 |
| Volts, max. | 15 |
| Input reverse polarity protection | None, install external fuse |
| Output Current, sustained short circuit | Current-limited, see specs |
| Storage Temperature Range | |
| min. °C. | -55 |
| max. °C. | +125 |
| Lead Temperature, °C. max.(soldering, ten seconds) | See soldering guidelines |

PERFORMANCE DATA, BEI15-050-Q12

Efficiency vs. Line Voltage and Load Current @ +25°C



Power Dissipation vs. Line Voltage and Load Current @ +25°C



Maximum Current Temperature Derating at Sea Level
(V_{IN} = 9V to 36V, airflow is from pin 1 to pin 3)

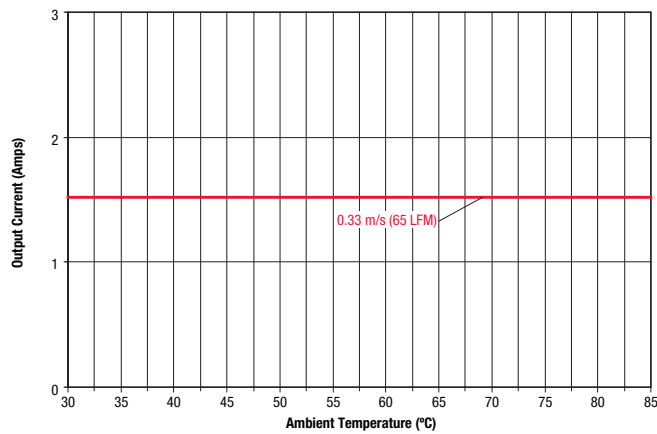

PERFORMANCE DATA, BEI15-050-Q48

Efficiency vs. Line Voltage and Load Current @ +25°C



Power Dissipation vs. Load Current @ +25°C



**Maximum Current Temperature Derating at Sea Level
(V_{IN} = 18 to 75V, airflow is from pin 1 to pin 2)**

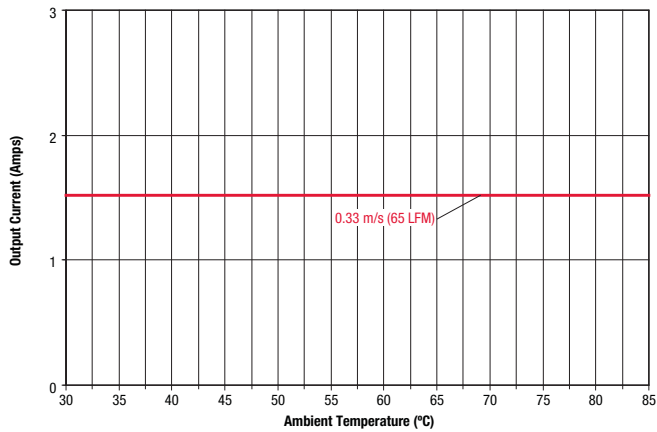

**Maximum Current Temperature Derating at Sea level
(V_{IN} = 18 to 75V, natural convection)**



PERFORMANCE DATA, BEI15-120-Q12

Efficiency vs. Line Voltage and Load Current @ +25°C



Power Dissipation vs. Load Current @ +25°C



Maximum Current Temperature Derating at Sea Level
(V_{IN}= 9V to 36V, airflow is from pin 1 to pin 3)



PERFORMANCE DATA, BEI15-120-Q48

Efficiency vs. Line Voltage and Load Current @ +25°C (Vout = 12V)

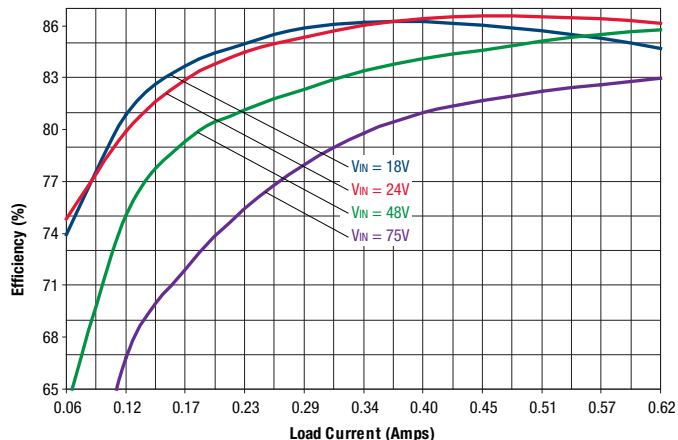

Power Dissipation vs. Load Current @ +25°C

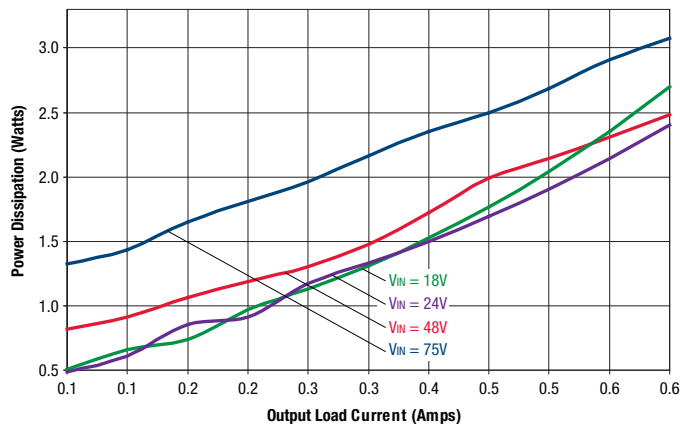

Maximum Current Temperature Derating at Sea Level
(V_{IN}= 18V, airflow is from pin 1 to pin 2)

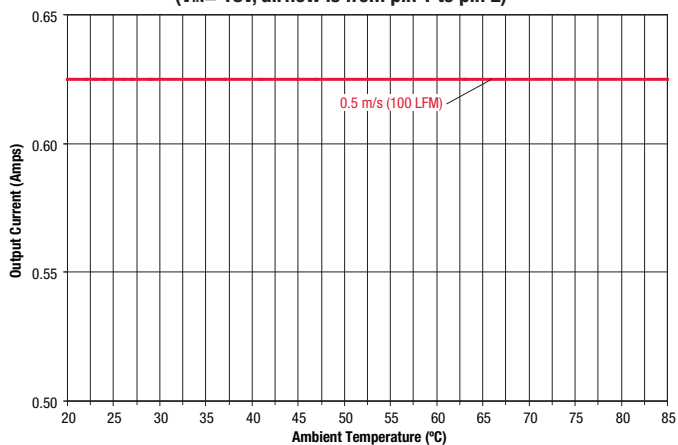

Maximum Current Temperature Derating at Sea Level
(V_{IN}=24V, airflow is from pin 1 to pin 2)

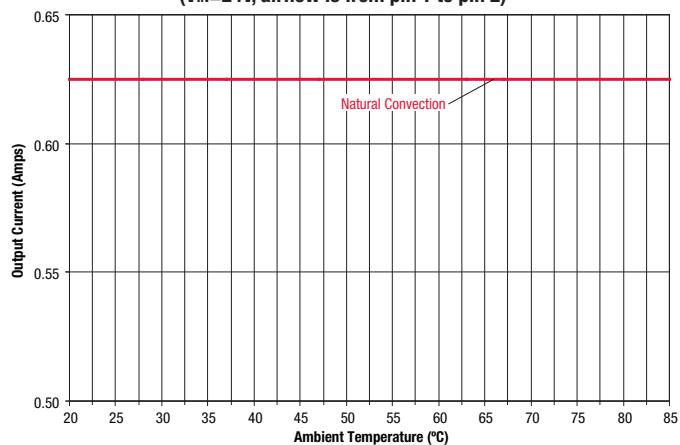

Maximum Current Temperature Derating at Sea Level
(V_{IN}= 48V, airflow is from pin 1 to pin 2)

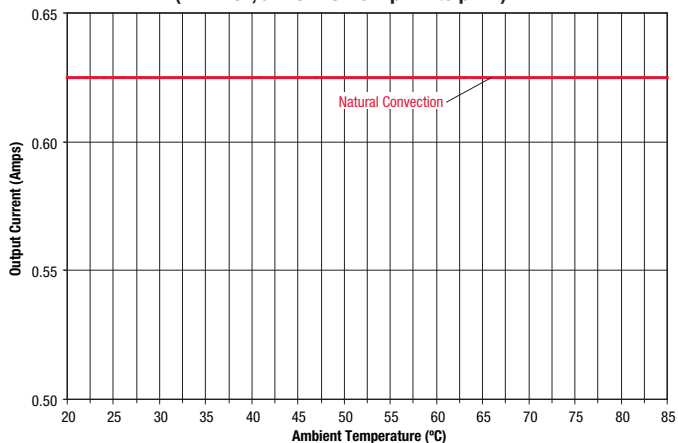

Maximum Current Temperature Derating at Sea Level
(V_{IN}= 75V, airflow is from pin 1 to pin 2)

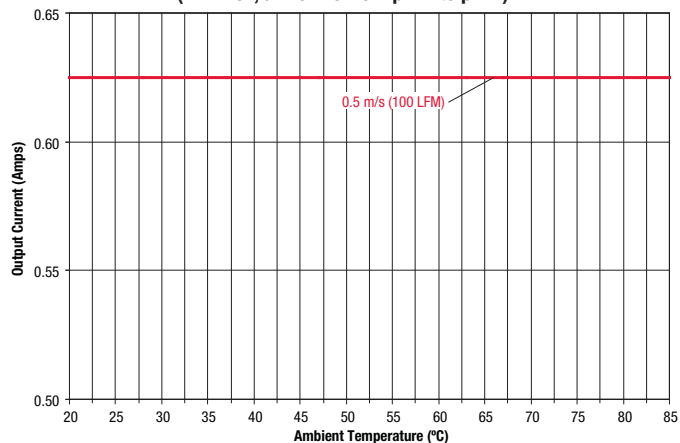

PERFORMANCE DATA, BEI15-150-Q12

Efficiency vs. Line Voltage and Load Current @ +25°C



Power Dissipation vs. Load Current @ +25°C



**Maximum Current Temperature Derating at Sea Level
(V_{IN}= 9V to 36V, airflow is from pin 1 to pin 3)**

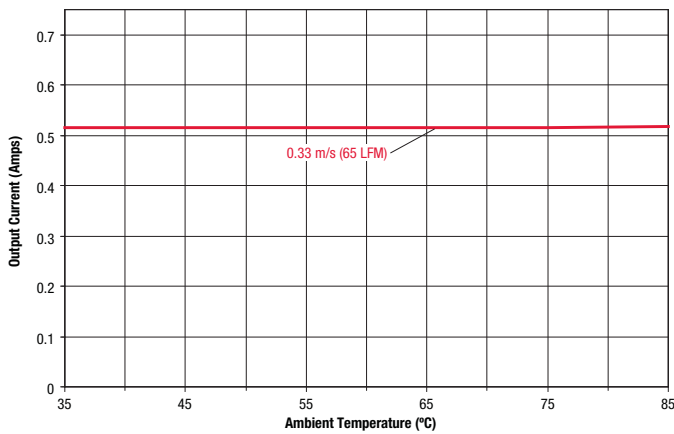

**Maximum Current Temperature Derating at Sea Level
(Natural convection)**

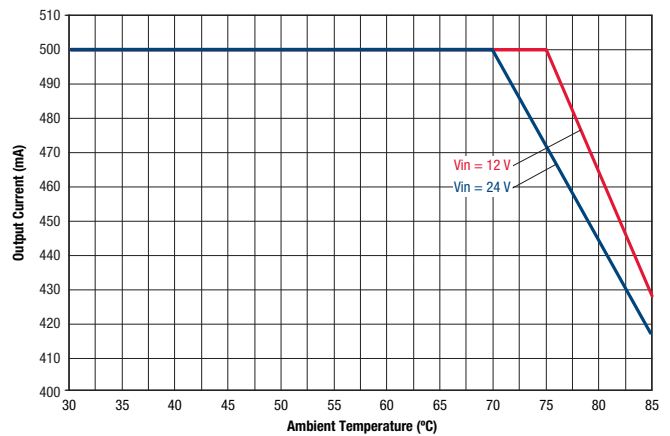

PERFORMANCE DATA, BEI15-150-Q48

Efficiency vs. Line Voltage and Load Current @ +25°C

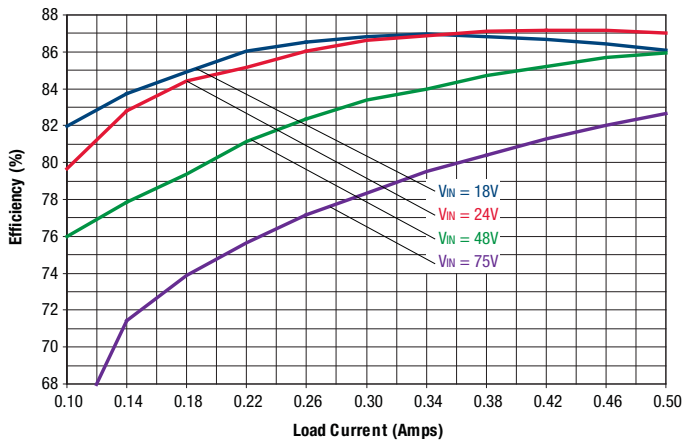

Power Dissipation vs. Line Voltage and Load Current @ +25°C

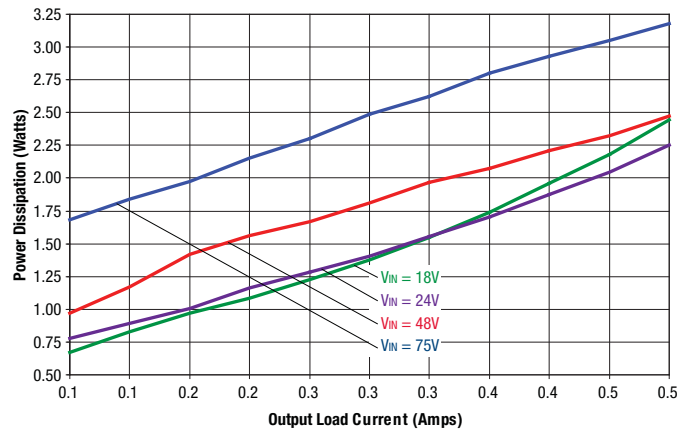

Maximum Current Temperature Derating at Sea Level
(V_{IN}= 18 to 75V, airflow is from pin 1 to pin 2)

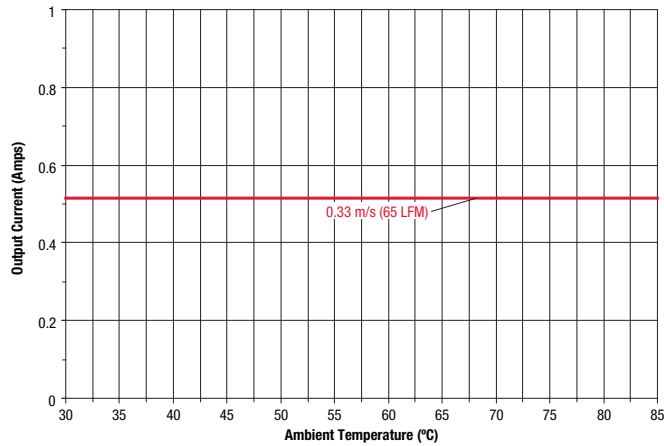

MECHANICAL SPECIFICATIONS, OPEN FRAME



Dimensions are in inches (mm shown for ref. only).



Tolerances (unless otherwise specified):

.XX ± 0.02 (0.5)

.XXX ± 0.010 (0.25)

Angles ± 1°

Components are shown for reference only.

INPUT/OUTPUT CONNECTIONS

| Pin | Function |
|-----|------------------|
| 1 | Positive Vin |
| 2 | Negative Vin |
| 3 | On/Off Control * |
| 4 | Negative Vout |
| 5 | Common Return |
| 6 | Positive Vout |

*The Remote On/Off can be provided with either positive (P suffix) or negative (N suffix) logic.

Some competitive units may use different pin numbers; however, the BEI is plug compatible. Follow the pin FUNCTION when laying out your PC board.

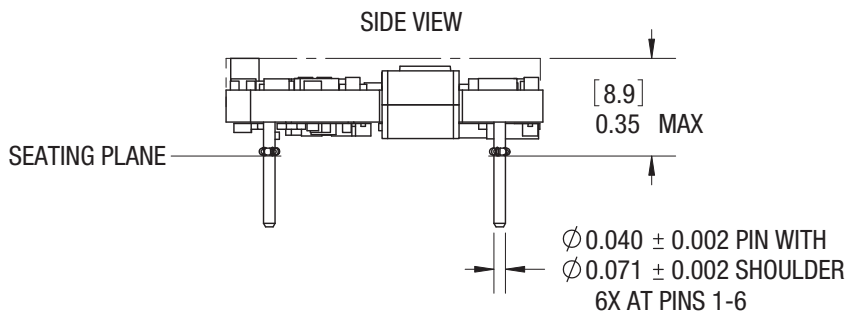

BOTTOM VIEW (PIN SIDE)

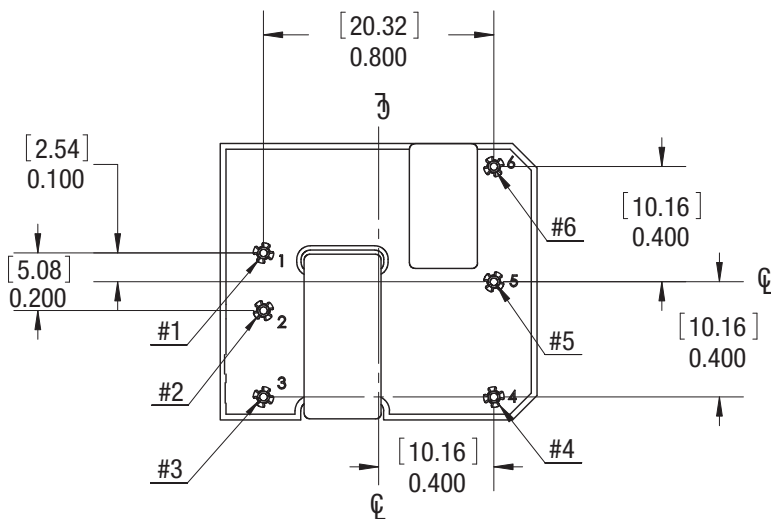

Standard pin length is shown. Please refer to the Ordering Guide for alternate pin lengths.

END VIEW

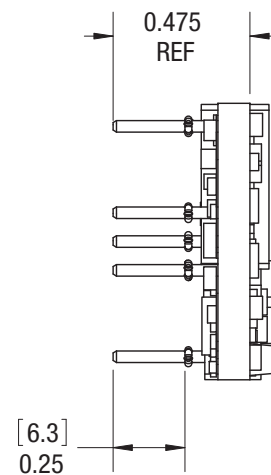

SHIPPING TRAYS AND BOXES, THROUGH-HOLE MOUNT



SHIPPING TRAY DIMENSIONS

BEI modules are supplied in a 30-piece (6 x 5) shipping tray. The tray is an anti-static closed-cell polyethylene foam. Dimensions are shown below.



Notes:

1. Material: Dow 220 antistat ethafoam (Density: 34-35 kg/m³)
2. Dimensions: 252 x 252 x 19.1 mm
6 x 5 array (30 per tray)
3. All dimensions in millimeters [inches]
4. Tolerances unless otherwise specified: +1/-0

TECHNICAL NOTES

Input Fusing

Certain applications and/or safety agencies may require fuses at the inputs of power conversion components. Fuses should also be used when there is the possibility of sustained input voltage reversal which is not current-limited. For greatest safety, we recommend a fast blow fuse installed in the ungrounded input supply line.

The installer must observe all relevant safety standards and regulations. For safety agency approvals, install the converter in compliance with the end-user safety standard.

Input Under-Voltage Shutdown and Start-Up Threshold

Under normal start-up conditions, converters will not begin to regulate properly until the rising input voltage exceeds and remains at the Start-Up Threshold Voltage (see Specifications). Once operating, converters will not turn off until the input voltage drops below the Under-Voltage Shutdown Limit. Subsequent restart will not occur until the input voltage rises again above the Start-Up Threshold. This built-in hysteresis prevents any unstable on/off operation at a single input voltage.

Users should be aware however of input sources near the Under-Voltage Shutdown whose voltage decays as input current is consumed (such as poorly regulated capacitor inputs), the converter shuts off and then restarts as the external capacitor recharges. Such situations could oscillate. To prevent this, make sure the operating input voltage is well above the UV Shutdown voltage AT ALL TIMES.

Start-Up Delay

Assuming that the output current is set at the rated maximum, the Vin to Vout Start-Up Delay (see Specifications) is the time interval between the point when the rising input voltage crosses the Start-Up Threshold and the fully loaded regulated output voltage enters and remains within its specified regulation band. Actual measured times will vary with input source impedance, external input capacitance, input voltage slew rate and final value of the input voltage as it appears at the converter.

These converters include a soft start circuit to moderate the duty cycle of the PWM controller at power up, thereby limiting the input inrush current.

The On/Off Remote Control interval from inception to Vout regulated assumes that the converter already has its input voltage stabilized above the Start-Up Threshold before the On command. The interval is measured from the On command until the output enters and remains within its specified accuracy band. The specification assumes that the output is fully loaded at maximum rated current.

Recommended Input Filtering

The user must assure that the input source has low AC impedance to provide dynamic stability and that the input supply has little or no inductive content, including long distributed wiring to a remote power supply. The converter will operate with no additional external capacitance if these conditions are met.

For best performance, we recommend installing a low-ESR capacitor immediately adjacent to the converter's input terminals. The capacitor should be a ceramic type such as the Murata GRM32 series or a polymer type. Initial

suggested capacitor values are 10 to 22 μF , rated at twice the expected maximum input voltage. Make sure that the input terminals do not go below the undervoltage shutdown voltage at all times. More input bulk capacitance may be added in parallel (either electrolytic or tantalum) if needed.

Recommended Output Filtering

The converter will achieve its rated output ripple and noise with no additional external capacitor. However, the user may install more external output capacitance to reduce the ripple even further or for improved dynamic response. Again, use low-ESR ceramic (Murata GRM32 series) or polymer capacitors. Initial values of 10 to 47 μF may be tried, either single or multiple capacitors in parallel. Mount these close to the converter. Measure the output ripple under your load conditions.

Use only as much capacitance as required to achieve your ripple and noise objectives. Excessive capacitance can make step load recovery sluggish or possibly introduce instability. Do not exceed the maximum rated output capacitance listed in the specifications.

Input Ripple Current and Output Noise

All models in this converter series are tested and specified for input reflected ripple current and output noise using designated external input/output components, circuits and layout as shown in the figures below. The Cbus and Lbus components simulate a typical DC voltage bus. Please note that the values of Cin, Lbus and Cbus may vary according to the specific converter model.



Figure 2: Measuring Input Ripple Current



Figure 3: Measuring Output Ripple and Noise (PAR)

Minimum Output Loading Requirements

All models regulate within specification and are stable under 10% minimum load to full load conditions. Operation under no load might however slightly increase output ripple and noise.

Thermal Shutdown

To protect against thermal overstress, these converters include thermal shutdown circuitry. If environmental conditions cause the temperature of the DC/DC's to rise above the Operating Temperature Range up to the shutdown temperature, an on-board electronic temperature sensor will power down the unit. When the temperature decreases below the turn-on threshold, the converter will automatically restart. There is a small amount of temperature hysteresis to prevent rapid on/off cycling.

CAUTION: If you operate too close to the thermal limits, the converter may shut down suddenly without warning. Be sure to thoroughly test your application to avoid unplanned thermal shutdown.

Temperature Derating Curves

The graphs in this data sheet illustrate typical operation under a variety of conditions. The Derating curves show the maximum continuous ambient air temperature and decreasing maximum output current which is acceptable under increasing forced airflow measured in Linear Feet per Minute ("LFM"). Note that these are AVERAGE measurements. The converter will accept brief increases in current or reduced airflow as long as the average is not exceeded.

Note that the temperatures are of the ambient airflow, not the converter itself which is obviously running at higher temperature than the outside air. Also note that very low flow rates (below about 25 LFM) are similar to "natural convection", that is, not using fan-forced airflow.

Murata Power Solutions makes Characterization measurements in a closed cycle wind tunnel with calibrated airflow. We use both thermocouples and an infrared camera system to observe thermal performance.

CAUTION: If you exceed these Derating guidelines, the converter may have an unplanned Over Temperature shut down. Also, these graphs are all collected near Sea Level altitude. Be sure to reduce the derating for higher altitude.

Output Current Limiting

Current limiting inception is defined as the point at which full power falls below the rated tolerance. See the Performance/Functional Specifications. Note particularly that the output current may briefly rise above its rated value in normal operation as long as the average output power is not exceeded. This enhances reliability and continued operation of your application. If the output current is too high, the converter will enter the short circuit condition.

Output Short Circuit Condition

When a converter is in current-limit mode, the output voltage will drop as the output current demand increases. If the output voltage drops too low (approximately 98% of nominal output voltage for most models), the PWM controller will shut down. Following a time-out period, the PWM will restart, causing the output voltage to begin rising to its appropriate value. If the short-circuit condition persists, another shutdown cycle will initiate. This rapid on/off cycling is called "hiccup mode". The hiccup cycling reduces the average output current, thereby preventing excessive internal temperatures and/or component damage.

Remote On/Off Control

The remote On/Off Control can be specified with either logic logic type. Please refer to the Connection Diagram on page 1 for On/Off connections.

Positive-logic models are enabled when the On/Off pin is left open or is pulled high to +Vin with respect to -Vin. Therefore, the On/Off control can be disconnected if the converter should always be on. Positive-logic devices are disabled when the On/Off is grounded or brought to within a low voltage (see Specifications) with respect to -Vin.

Negative-logic devices are on (enabled) when the On/Off pin is grounded or brought to within a low voltage (see Specifications) with respect to -Vin. The device is off (disabled) when the On/Off is pulled high (see Specifications) with respect to -Vin.

Dynamic control of the On/Off function must sink the specified signal current when brought low and withstand the specified voltage when brought high. Be aware too that there is a finite time in milliseconds (see Specifications) between the time of On/Off Control activation and stable, regulated output. This time will vary slightly with output load type and current and input conditions.

Output Capacitive Load

These converters do not require external capacitance added to achieve rated specifications. Users should only consider adding capacitance to reduce switching noise and/or to handle spike current load steps. Install only enough capacitance to achieve your noise and surge response objectives. Excess external capacitance may cause regulation problems and possible oscillation or instability.

The maximum rated output capacitance and ESR specification is given for a capacitor installed immediately adjacent to the converter.

Floating Outputs

Since these are isolated DC/DC converters, their outputs are "floating." Any BEI15 model may be configured to produce an output of 10V, 24V or 30V (for $\pm 5V$, $\pm 12V$ or $\pm 15V$ models, respectively) by applying the load across the +Output and -Output pins, with either output grounded. The Common pin should be left open. Minimum 20% loading is recommended under these conditions.

Soldering Guidelines

Murata Power Solutions recommends the specifications below when installing these converters. These specifications vary depending on the solder type. Exceeding these specifications may cause damage to the product. Your production environment may differ; therefore please thoroughly review these guidelines with your process engineers.

Wave Solder Operations for through-hole mounted products (THMT)

For Sn/Ag/Cu based solders:

| | |
|-----------------------------|-----------|
| Maximum Preheat Temperature | 115° C. |
| Maximum Pot Temperature | 270° C. |
| Maximum Solder Dwell Time | 7 seconds |

For Sn/Pb based solders:

| | |
|-----------------------------|-----------|
| Maximum Preheat Temperature | 105° C. |
| Maximum Pot Temperature | 250° C. |
| Maximum Solder Dwell Time | 6 seconds |

Emissions Performance

Murata Power Solutions measures its products for radio frequency emissions against the EN 55022 and CISPR 22 standards. Passive resistance loads are employed and the output is set to the maximum voltage. If you set up your own emissions testing, make sure the output load is rated at continuous power while doing the tests.

The recommended external input and output capacitors (if required) are included. Please refer to the fundamental switching frequency. All of this information is listed in the Product Specifications. An external discrete filter is installed and the circuit diagram is shown below.



Figure 4. Conducted Emissions Test Circuit

[1] Conducted Emissions Parts List

| Reference | Description |
|------------|-------------------------------------|
| L1 | 1mH, 6A |
| L3 | 500µH, 10A |
| C1, C2, C8 | 2.2µfd |
| C7 | Electrolytic Capacitor 100µfd, 100V |
| C16, C17 | .22µfd |
| C3, C4 | Electrolytic Capacitor 33µfd, 100V |

[2] Conducted Emissions Test Equipment Used

- Rohde & Schwarz EMI Test Receiver (9KHz – 1000MHz) ESPC
- Rohde & Schwarz Software ESPC-1 Ver. 2.20
- OHMITE 25W – 1 Ohm resistor combinations
- DC Source Programmable DC Power Supply Model 62012P-100-50

[3] Conducted Emissions Test Results



Graph 1. Conducted emissions performance with filter, CISPR 22, Class B, full load, for BEI15-150-Q12P-C

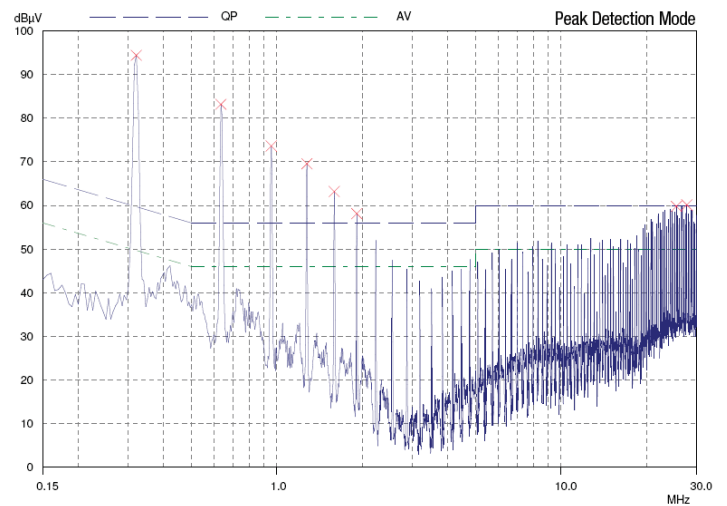

Graph 2. Conducted emissions performance without filter, CISPR 22, Class B, full load, for BEI15-150-Q12P-C

Murata Power Solutions, Inc.
 11 Cabot Boulevard, Mansfield, MA 02048-1151 U.S.A.
 ISO 9001 and 14001 REGISTERED



This product is subject to the following [operating requirements](#) and the [Life and Safety Critical Application Sales Policy](#): Refer to: <http://www.murata-ps.com/requirements/>

Murata Power Solutions, Inc. makes no representation that the use of its products in the circuits described herein, or the use of other technical information contained herein, will not infringe upon existing or future patent rights. The descriptions contained herein do not imply the granting of licenses to make, use, or sell equipment constructed in accordance therewith. Specifications are subject to change without notice. © 2012 Murata Power Solutions, Inc.



Компания «ЭлектроПласт» предлагает заключение долгосрочных отношений при поставках импортных электронных компонентов на взаимовыгодных условиях!

Наши преимущества:

- Оперативные поставки широкого спектра электронных компонентов отечественного и импортного производства напрямую от производителей и с крупнейших мировых складов;
- Поставка более 17-ти миллионов наименований электронных компонентов;
- Поставка сложных, дефицитных, либо снятых с производства позиций;
- Оперативные сроки поставки под заказ (от 5 рабочих дней);
- Экспресс доставка в любую точку России;
- Техническая поддержка проекта, помощь в подборе аналогов, поставка прототипов;
- Система менеджмента качества сертифицирована по Международному стандарту ISO 9001;
- Лицензия ФСБ на осуществление работ с использованием сведений, составляющих государственную тайну;
- Поставка специализированных компонентов (Xilinx, Altera, Analog Devices, Intersil, Interpoint, Microsemi, Aeroflex, Peregrine, Syfer, Eurofarad, Texas Instrument, Miteq, Cobham, E2V, MA-COM, Hittite, Mini-Circuits, General Dynamics и др.);

Помимо этого, одним из направлений компании «ЭлектроПласт» является направление «Источники питания». Мы предлагаем Вам помощь Конструкторского отдела:

- Подбор оптимального решения, техническое обоснование при выборе компонента;
- Подбор аналогов;
- Консультации по применению компонента;
- Поставка образцов и прототипов;
- Техническая поддержка проекта;
- Защита от снятия компонента с производства.



Как с нами связаться

Телефон: 8 (812) 309 58 32 (многоканальный)

Факс: 8 (812) 320-02-42

Электронная почта: org@eplast1.ru

Адрес: 198099, г. Санкт-Петербург, ул. Калинина, дом 2, корпус 4, литера А.