

FEATURES

Acquisition Time to 0.01%: 250 ns Typical
Low Power Dissipation: 95 mW
Low Droop Rate: 0.02 $\mu\text{V}/\mu\text{s}$
Fully Specified and Tested Hold Mode Distortion
Total Harmonic Distortion: -85 dB
Aperture Jitter: 50 ps Maximum
Internal Hold Capacitor
Self-Correcting Architecture
8-Pin Mini Cerdip and SOIC Packages

FUNCTIONAL BLOCK DIAGRAM

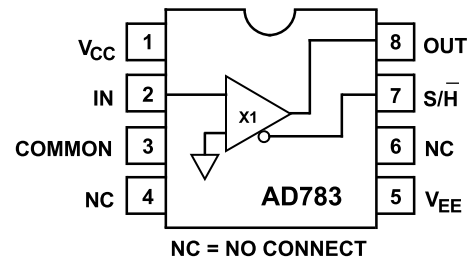

PRODUCT DESCRIPTION

The AD783 is a high speed, monolithic sample-and-hold amplifier (SHA). The AD783 offers a typical acquisition time of 250 ns to 0.01%. The AD783 is specified and tested for hold mode total harmonic distortion with input frequencies up to 100 kHz. The AD783 is configured as a unity gain amplifier and uses a patented self-correcting architecture that minimizes hold mode errors and ensures accuracy over temperature. The AD783 is self-contained and requires no external components or adjustments.

The AD783 retains the held value with a droop rate of 0.02 $\mu\text{V}/\mu\text{s}$. Excellent linearity and hold mode dc and dynamic performance make the AD783 ideal for high speed 12- and 14-bit analog-to-digital converters.

The AD783 is manufactured on Analog Devices' ABCMOS process which merges high performance, low noise bipolar circuitry with low power CMOS to provide an accurate, high speed, low power SHA.

PRODUCT HIGHLIGHTS

1. Fast acquisition time (250 ns), low aperture jitter (20 ps) and fully specified hold mode distortion make the AD783 an ideal SHA for sampling systems.
2. Low droop (0.02 $\mu\text{V}/\mu\text{s}$) and internally compensated hold mode error result in superior system accuracy.
3. Low power (95 mW typical), complete functionality and small size make the AD783 an ideal choice for a variety of high performance applications.
4. The AD783 requires no external components or adjustments.
5. The AD783 is an excellent choice as a front-end SHA for high speed analog-to-digital converters such as the AD671, AD7586, AD674B, AD774B, AD7572 and AD7672.
6. Fully specified and tested hold mode distortion guarantees the performance of the SHA in sampled data systems.

REV. B

Information furnished by Analog Devices is believed to be accurate and reliable. However, no responsibility is assumed by Analog Devices for its use, nor for any infringements of patents or other rights of third parties which may result from its use. No license is granted by implication or otherwise under any patent or patent rights of Analog Devices.

AD783—SPECIFICATIONS

DC SPECIFICATIONS (T_{MIN} to T_{MAX} with $V_{CC} = +5\text{ V} \pm 5\%$, $V_{EE} = -5\text{ V} \pm 5\%$, $C_L = \text{pF}$, unless otherwise noted)

Parameter	Min	AD783J Typ	Max	Units
SAMPLING CHARACTERISTICS				
Acquisition Time				
5 V Step to 0.01%		250	375	ns
5 V Step to 0.1%		200	350	ns
Small Signal Bandwidth		15		MHz
Full Power Bandwidth		2		MHz
HOLD CHARACTERISTICS				
Effective Aperture Delay (+25°C)	-30	15	30	ns
Aperture Jitter (+25°C)		20	50	ps
Hold Settling (to 1 mV, +25°C)		150	200	ns
Droop Rate		0.02	1	$\mu\text{V}/\mu\text{s}$
Feedthrough (+25°C) ($V_{IN} = \pm 2.5\text{ V}$, 500 kHz)		-80		dB
ACCURACY CHARACTERISTICS¹				
Hold Mode Offset	-5	0	+5	mV
Hold Mode Offset Drift		10		$\mu\text{V}/^\circ\text{C}$
Sample Mode Offset		50	200	mV
Nonlinearity		± 0.005		% FS
Gain Error		± 0.03	± 0.1	% FS
OUTPUT CHARACTERISTICS				
Output Drive Current	-5		+5	mA
Output Resistance, DC		0.3	0.6	Ω
Total Output Noise (DC to 5 MHz)		150		$\mu\text{V rms}$
Sampled DC Uncertainty		85		$\mu\text{V rms}$
Hold Mode Noise (DC to 5 MHz)		125		$\mu\text{V rms}$
Short Circuit Current				
Source			20	mA
Sink			13	mA
INPUT CHARACTERISTICS				
Input Voltage Range	-2.5		+2.5	V
Bias Current		100	250	nA
Input Impedance		10		$M\Omega$
Input Capacitance		2		pF
DIGITAL CHARACTERISTICS				
Input Voltage Low			0.8	V
Input Voltage High	2.0			V
Input Current High ($V_{IN} = 5\text{ V}$)		2	10	μA
POWER SUPPLY CHARACTERISTICS				
Operating Voltage Range	± 4.75	± 5	± 5.25	V
Supply Current		9.5	17	mA
+PSRR (+5 V \pm 5%)	45	65		dB
-PSRR (-5 V \pm 5%)	45	65		dB
Power Consumption		95	175	mW
TEMPERATURE RANGE				
Specified Performance (J)	0		+70	$^\circ\text{C}$

NOTES

¹Specified and tested over an input range of $\pm 2.5\text{ V}$.

Specifications subject to change without notice.

HOLD MODE AC SPECIFICATIONS (T_{MIN} to T_{MAX} with $V_{CC} = +5\text{ V} \pm 5\%$, $V_{EE} = -5\text{ V} \pm 5\%$, $C_L = 50\text{ pF}$, unless otherwise noted)

Parameter	AD783J			Units
	Min	Typ	Max	
TOTAL HARMONIC DISTORTION				
$f_{IN} = 100\text{ kHz}$		-85	-80	dB
$f_{IN} = 500\text{ kHz}$		-72		dB
SIGNAL-TO-NOISE AND DISTORTION				
$f_{IN} = 100\text{ kHz}$		77		dB
$f_{IN} = 500\text{ kHz}$		70		dB
INTERMODULATION DISTORTION (F1 = 99 kHz, F2 = 100 kHz)				
Second Order Products		-80		dB
Third Order Products		-85		dB

NOTES

¹ f_{IN} amplitude = 0 dB and $f_{SAMPLE} = 300\text{ kHz}$ unless otherwise indicated.

Specifications subject to change without notice.

ABSOLUTE MAXIMUM RATINGS*

Spec	With Respect to	Min		Max		Units
V_{CC}	COM	-0.5	+6.5			V
V_{EE}	COM	-6.5	+0.5			V
Analog Input	COM	-6.5	+6.5			V
Digital Input	COM	-0.5	+6.5			V
Output Short Circuit to Ground, V_{CC} , or V_{EE}		Indefinite				
Maximum Junction Temperature				+175		°C
Storage Temperature		-65		+150		°C
Lead Temperature (10 sec max)				+300		°C

*Stresses above those listed under "Absolute Maximum Ratings" may cause permanent damage to the device. This is a stress rating only and functional operation of the device at these or any other conditions above those indicated in the operational section of this specification is not implied.

CAUTION

ESD (electrostatic discharge) sensitive device. Electrostatic charges as high as 4000 V readily accumulate on the human body and test equipment and can discharge without detection. Although the AD783 features proprietary ESD protection circuitry, permanent damage may occur on devices subjected to high energy electrostatic discharges. Therefore, proper ESD precautions are recommended to avoid performance degradation or loss of functionality.

PIN CONFIGURATION

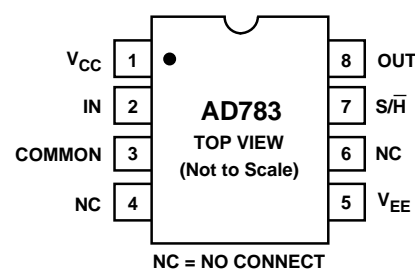

AD783—Typical Characteristics

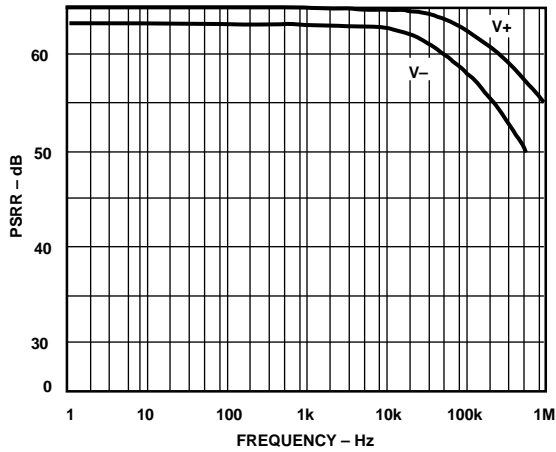

Power Supply Rejection Ratio vs. Frequency

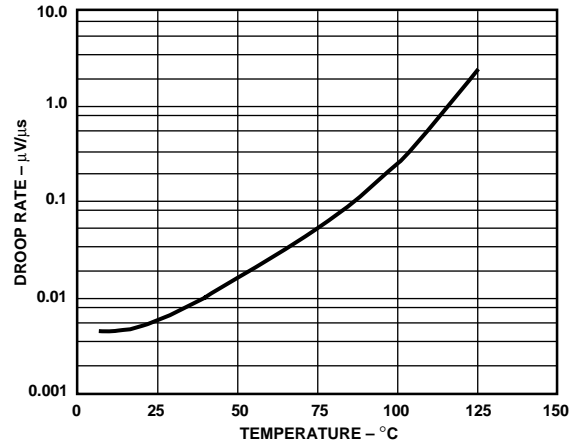

Droop Rate vs. Temperature, $V_{IN} = 0\text{ V}$

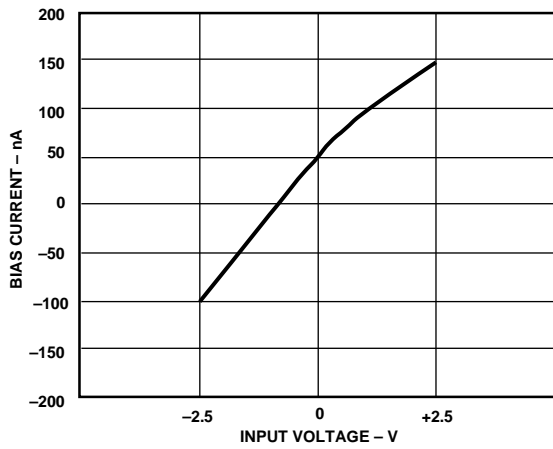

Bias Current vs. Input Voltage

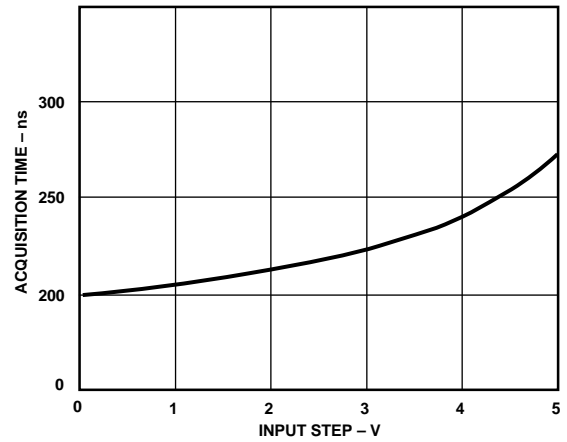

Acquisition Time (to 0.01%) vs. Input Step Size

DEFINITIONS OF SPECIFICATIONS

Acquisition Time—The length of time that the SHA must remain in the sample mode in order to acquire a full-scale input step to a given level of accuracy.

Small Signal Bandwidth—The frequency at which the held output amplitude is 3 dB below the input amplitude, under an input condition of a 100 mV p-p sine wave.

Full Power Bandwidth—The frequency at which the held output amplitude is 3 dB below the input amplitude, under an input condition of a 5 V p-p sine wave.

Effective Aperture Delay—The difference between the switch delay and the analog delay of the SHA channel. A negative number indicates that the analog portion of the overall delay is greater than the switch portion. This effective delay represents the point in time, relative to the hold command, that the input signal will be sampled.

Aperture Jitter—The variations in aperture delay for successive samples. Aperture jitter puts an upper limit on the maximum frequency that can be accurately sampled.

Hold Settling Time—The time required for the output to settle to within a specified level of accuracy of its final held value after the hold command has been given.

Droop Rate—The drift in output voltage while in the hold mode.

Feedthrough—The attenuated version of a changing input signal that appears at the output when the SHA is in the hold mode.

Hold Mode Offset—The difference between the input signal and the held output. This offset term applies only in the hold mode and includes the error caused by charge injection and all other internal offsets. It is specified for an input of 0 V.

Sample Mode Offset—The difference between the input and output signals when the SHA is in the sample mode.

Nonlinearity—The deviation from a straight line on a plot of input vs. (held) output as referenced to a straight line drawn between endpoints, over an input range of -2.5 V and $+2.5$ V.

Gain Error—Deviation from a gain of +1 on the transfer function of input vs. held output.

Power Supply Rejection Ratio—A measure of change in the held output voltage for a specified change in the positive or negative supply.

Sampled DC Uncertainty—The internal rms SHA noise that is sampled onto the hold capacitor.

Hold Mode Noise—The rms noise at the output of the SHA while in the hold mode, specified over a given bandwidth.

Total Output Noise—The total rms noise that is seen at the output of the SHA while in the hold mode. It is the rms summation of the sampled dc uncertainty and the hold mode noise.

Output Drive Current—The maximum current the SHA can source (or sink) while maintaining a change in hold mode offset of less than 2.5 mV.

Signal-To-Noise and Distortion (S/N+D) Ratio—S/N+D is the ratio of the rms value of the measured input signal to the rms sum of all other spectral components below the Nyquist frequency, including harmonics but excluding dc. The value for S/N+D is expressed in decibels.

Total Harmonic Distortion (THD)—THD is the ratio of the rms sum of the first six harmonic components to the rms value of the measured input signal and is expressed in decibels.

Intermodulation Distortion (IMD)—With inputs consisting of sine waves at two frequencies, f_a and f_b , any device with nonlinearities will create distortion products, of order $(m+n)$, at sum and difference frequency of $m f_a \pm n f_b$, where $m, n = 0, 1, 2, 3, \dots$. Intermodulation terms are those for which m or n is not equal to zero. For example, the second order terms are (f_a+f_b) and (f_a-f_b) , and the third order terms are $(2f_a+f_b)$, $(2f_a-f_b)$, (f_a+2f_b) and (f_a-2f_b) . The IMD products are expressed as the decibel ratio of the rms sum of the measured input signals to the rms sum of the distortion terms. The two signals are of equal amplitude, and peak value of their sums is -0.5 dB from full scale. The IMD products are normalized to a 0 dB input signal.

FUNCTIONAL DESCRIPTION

The AD783 is a complete, high speed sample-and-hold amplifier that provides high speed sampling to 12-bit accuracy in 250 ns.

The AD783 is completely self-contained, including an on-chip hold capacitor, and requires no external components or adjustments to perform the sampling function. Both input and output are treated as a single-ended signal, referred to common.

The AD783 utilizes a proprietary circuit design which includes a self-correcting architecture. This sample-and-hold circuit corrects for internal errors after the hold command has been given, by compensating for amplifier gain and offset errors, and charge injection errors. Due to the nature of the design, the SHA output in the sample mode is not intended to provide an accurate representation of the input. However, in hold mode, the internal circuitry is reconfigured to produce an accurately held version of the input signal. Below is a block diagram of the AD783.

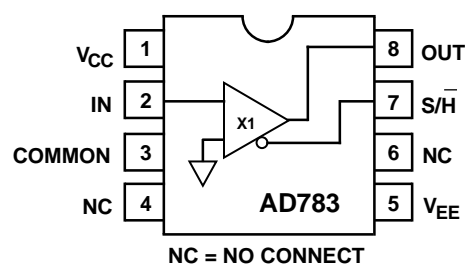

Functional Block Diagram

AD783

DYNAMIC PERFORMANCE

The AD783 is compatible with 12-bit A-to-D converters in terms of both accuracy and speed. The fast acquisition time, fast hold settling time and good output drive capability allow the AD783 to be used with high speed, high resolution A-to-D converters like the AD671 and AD7586. The AD783's fast acquisition time provides high throughput rates for multichannel data acquisition systems. Typically, the AD783 can acquire a 5 V step in less than 250 ns. Figure 1 shows the settling accuracy as a function of acquisition time.

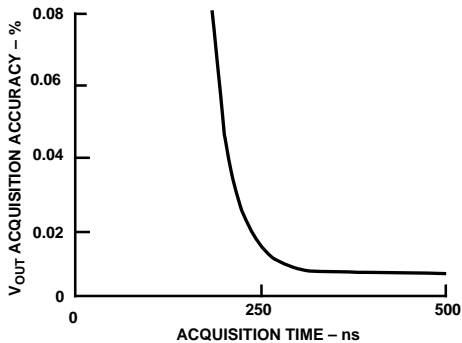

Figure 1. V_{OUT} Settling vs. Acquisition Time

The hold settling determines the required time, after the hold command is given, for the output to settle to its final specified accuracy. The typical settling behavior of the AD783 is 150 ns. The settling time of the AD783 is sufficiently fast to allow the SHA, in most cases, to directly drive an A-to-D converter without the need for an added "start convert" delay.

HOLD MODE OFFSET

The dc accuracy of the AD783 is determined primarily by the hold mode offset. The hold mode offset refers to the difference between the final held output voltage and the input signal at the time the hold command is given. The hold mode offset arises from a voltage error introduced onto the hold capacitor by charge injection of the internal switches. The nominal hold mode offset is specified for a 0 V input condition. Over the input range of -2.5 V to +2.5 V, the AD783 is also characterized for an effective gain error and nonlinearity of the held value, as shown in Figure 2. As indicated by the AD783 specifications, the hold mode offset is very stable over temperature.

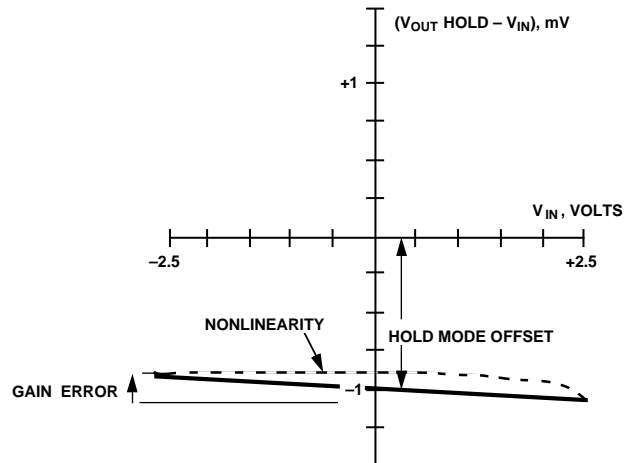

Figure 2. Hold Mode Offset, Gain Error and Nonlinearity

For applications where it is important to obtain zero offset, the hold mode offset may be nulled externally at the input to the A-to-D converter. Adjustment of the offset may be accomplished through the A-to-D itself or by an external amplifier with offset nulling capability (e.g., AD711). The offset will change less than 0.5 mV over the specified temperature range.

SUPPLY DECOUPLING AND GROUNDING CONSIDERATIONS

As with any high speed, high resolution data acquisition system, the power supplies should be well regulated and free from excessive high frequency noise (ripple). The supply connection to the AD783 should also be capable of delivering transient currents to the device. To achieve the specified accuracy and dynamic performance, decoupling capacitors must be placed directly at both the positive and negative supply pins to common. Ceramic type 0.1 μF capacitors should be connected from V_{CC} and V_{EE} to common.

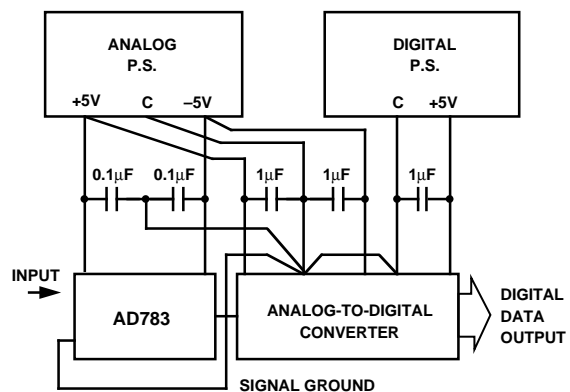

Figure 3. Basic Grounding and Decoupling Diagram

The AD783 does not provide separate analog and digital ground leads as is the case with most A-to-D converters. The common pin is the single ground terminal for the device. It is the reference point for the sampled input voltage and the held output voltage and also the digital ground return path. The common pin should be connected to the reference (analog) ground of the A-to-D converter with a separate ground lead. Since the analog and digital grounds in the AD783 are connected internally, the common pin should also be connected to the digital ground, which is usually tied to analog common at the A-to-D converter. Figure 3 illustrates the recommended decoupling and grounding practice.

NOISE CHARACTERISTICS

Designers of data conversion circuits must also consider the effect of noise sources on the accuracy of the data acquisition system. A sample-and-hold amplifier that precedes the A-to-D converter introduces some noise and represents another source of uncertainty in the conversion process. The noise from the AD783 is specified as the total output noise, which includes both the sampled wideband noise of the SHA in addition to the band limited output noise. The total output noise is the rms sum of the sampled dc uncertainty and the hold mode noise. A plot of the total output noise vs. the equivalent input bandwidth of the converter being used is given in Figure 4.

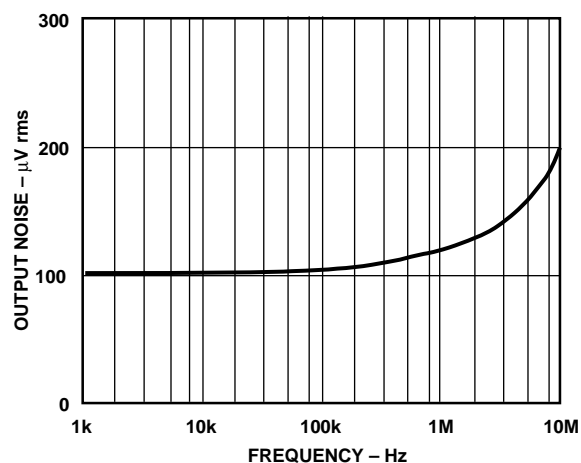

Figure 4. RMS Noise vs. Input Bandwidth of ADC

DRIVING THE ANALOG INPUTS

For best performance, it is important to drive the AD783 analog input from a low impedance signal source. This enhances the sampling accuracy by minimizing the analog and digital crosstalk. Signals which come from higher impedance sources (e.g., over 5 k Ω) will have a relatively higher level of crosstalk. For applications where signals have high source impedance, an operational amplifier buffer in front of the AD783 is required. The AD711 (precision BiFET op amp) is recommended for these applications.

HIGH FREQUENCY SAMPLING

Aperture jitter and distortion are the primary factors which limit frequency domain performance of a sample-and-hold amplifier. Aperture jitter modulates the phase of the hold command and produces an effective noise on the sampled analog input. The magnitude of the jitter induced noise is directly related to the frequency of the input signal.

A graph showing the magnitude of the jitter induced error vs. frequency of the input signal is given in Figure 5.

The accuracy in sampling high frequency signals is also constrained by the distortion and noise created by the sample-and-hold. The level of distortion increases with frequency and reduces the “effective number of bits” of the conversion.

Measurements of Figures 6 and 7 were made using a 14-bit A/D converter with $V_{IN} = 5\text{ V p-p}$ and a sample frequency of 100 kSPS.

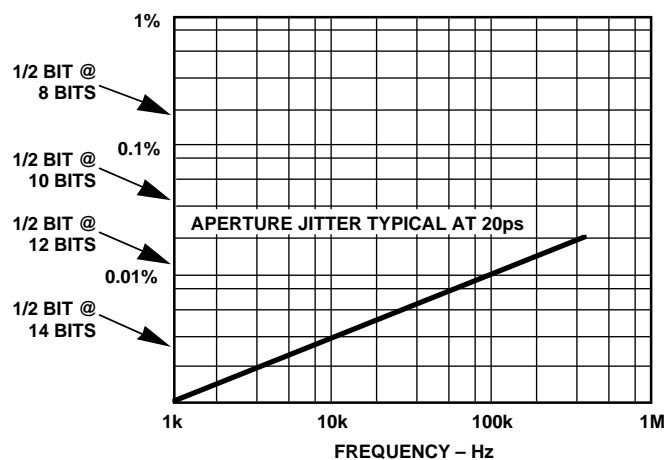

Figure 5. Error Magnitude vs. Frequency

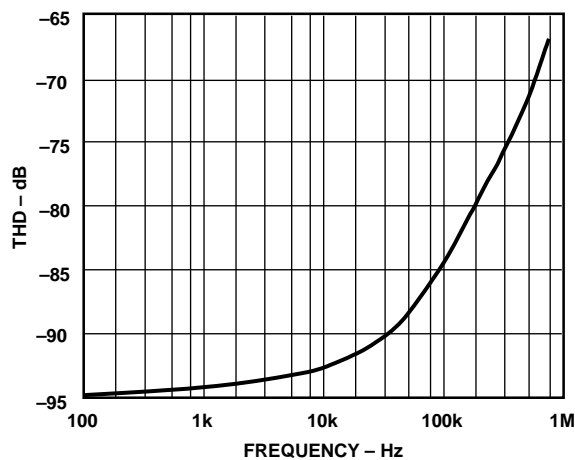

Figure 6. Total Harmonic Distortion vs. Frequency

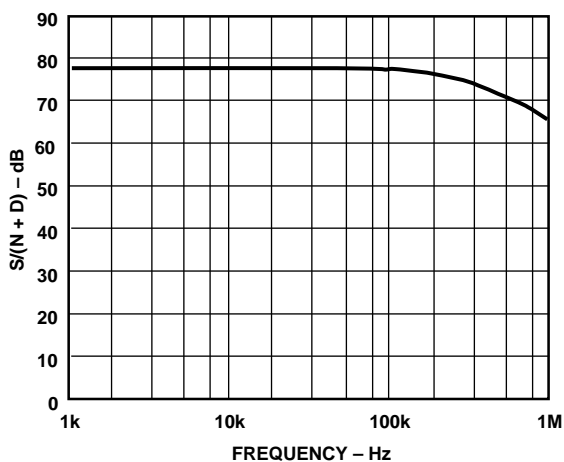

Figure 7. Signal/(Noise and Distortion) vs. Frequency

AD783

AD783 TO AD670 INTERFACE

The 15 MHz small signal bandwidth of the AD783 makes it a good choice for undersampling applications. Figure 8 shows the interface between the AD783 and the AD670 ADC, where the AD783 samples the incoming IF signal. For this particular application, the IF carrier was 10.7 MHz and the information signal was a 5 kHz FSK-modulated tone. The sample-and-hold signal is applied to the 8-bit AD670 ADC and then digitally processed for analysis.

The CLKIN signal is connected directly to the S/H pin of the AD783 and must comply with the acquisition and settling requirements of the SHA. A delayed version of CLKIN is applied to the R/\overline{W} input of the AD670 in order to accommodate the hold-mode settling requirements of the AD783. The 10 μ s conversion speed of the AD670 combined with the 150 ns hold-mode settling time of the AD783 result in a total system throughput of 10.15 μ s.

By keeping the 10.7 MHz IF input to the AD783 at a low amplitude, 255 mV p-p, the resultant distortion and jitter-induced noise result in approximately 45 dB of dynamic range. The AD670 can be conveniently configured such that its full-scale input range is 255 mV in order to retain the full 8-bit dynamic range of the converter. The maximum sample rate of the AD670 is 10 μ s; therefore, to comply with the Nyquist criteria the maximum information bandwidth is 50 kHz.

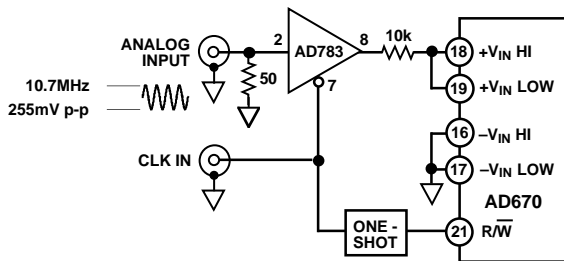

Figure 8. AD783 to AD670 Interface

AD783 to AD671 (12-Bit, 500 ns ADC) Interface

The AD783 to AD671 interface requires an op amp, a dual flip-flop, and a monostable multivibrator or "one-shot." The op amp amplifies the ± 2.5 V output of the AD783 to the full-scale input of the AD671. Appropriate op amps include the AD841 and AD845 (see the AD671 data sheet for additional information). The flip-flops and one-shot are used to generate the AD671 ENCODE pulse and the appropriately timed AD783 S/H pulse.

A master sampling clock is tied to the clock input of flip-flop1 and the input of the one-shot. The D1 input of flip-flop1 should be tied high and the one-shot should be configured to generate a pulse on a rising edge of the sampling clock. The rising edge of the sampling clock causes the $\overline{Q1}$ output of the flip-flop to go low placing the AD783 into hold mode. Simultaneously, a low going pulse is generated at the one-shot output. The length of this pulse would usually be made long enough to allow the output of the AD783 to settle (hold-mode settling time), but because of the error-correcting ability of the AD671, the length of this pulse may be reduced to approximately 200 ns.

The low going one-shot output is connected to the clock input of flip-flop2. The D2 input of flip-flop2 is tied high. The rising edge of the low going pulse toggles the Q2 output of flip-flop2 to a high state. This output, which is tied to the ENCODE input of the AD671, initiates a conversion of the buffered output signal of the AD783. The AD671 issues the signal DAV when the conversion is complete. The DAV signal is tied to the asynchronous $\overline{CLR1}$ and $\overline{CLR2}$ inputs of both flip-flops. When DAV goes low, the $\overline{Q1}$ output goes high returning the AD783 to the sample or acquisition mode. The Q2 output (ENCODE) returns low until it is again triggered by the rising edge of the one-shot output.

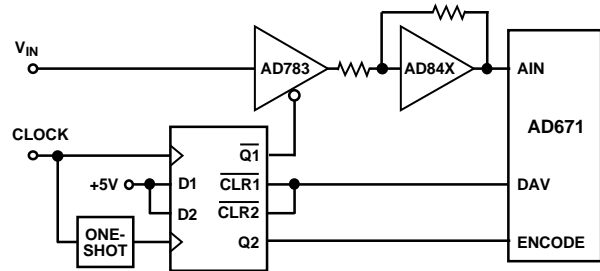
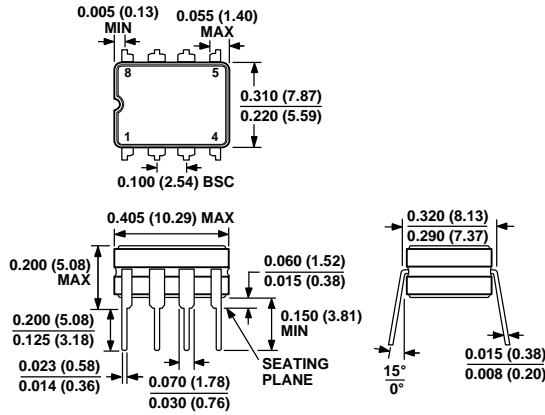

Figure 9. AD783 to AD671 Interface

OUTLINE DIMENSIONS



CONTROLLING DIMENSIONS ARE IN INCHES; MILLIMETER DIMENSIONS (IN PARENTHESES) ARE ROUNDED-OFF INCH EQUIVALENTS FOR REFERENCE ONLY AND ARE NOT APPROPRIATE FOR USE IN DESIGN.

Figure 10. 8-Lead Ceramic Dual In-Line Package [CERDIP] (Q-8)

Dimensions shown in inches and (millimeters)

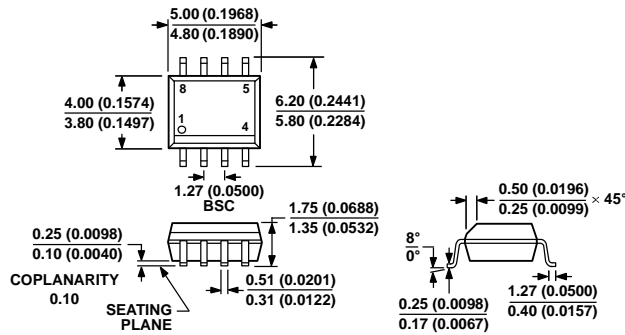

COMPLIANT TO JEDEC STANDARDS MS-012-AA
CONTROLLING DIMENSIONS ARE IN MILLIMETERS; INCH DIMENSIONS (IN PARENTHESES) ARE ROUNDED-OFF MILLIMETER EQUIVALENTS FOR REFERENCE ONLY AND ARE NOT APPROPRIATE FOR USE IN DESIGN.

Figure 11. 8-Lead Standard Small Outline Package [SOIC_N] Narrow Body (R-8)

Dimensions shown in millimeters and (inches)

ORDERING GUIDE

Model ¹	Temperature Range	Package Description	Package Option
AD783JQ	0°C to +70°C	8-Lead CERDIP	Q-8
AD783JR	0°C to +70°C	8-Lead SOIC	R-8
AD783JRZ	0°C to +70°C	8-Lead SOIC	R-8

¹ Z = RoHS Compliant Part.

REVISION HISTORY

10/14—Rev. A to Rev. B

Deleted A Model	Universal
Changes to Product Description	1
Updated Outline Dimensions.....	9
Changes to Ordering Guide.....	9

10/92—Rev. 0 to Rev. A



Компания «ЭлектроПласт» предлагает заключение долгосрочных отношений при поставках импортных электронных компонентов на взаимовыгодных условиях!

Наши преимущества:

- Оперативные поставки широкого спектра электронных компонентов отечественного и импортного производства напрямую от производителей и с крупнейших мировых складов;
- Поставка более 17-ти миллионов наименований электронных компонентов;
- Поставка сложных, дефицитных, либо снятых с производства позиций;
- Оперативные сроки поставки под заказ (от 5 рабочих дней);
- Экспресс доставка в любую точку России;
- Техническая поддержка проекта, помощь в подборе аналогов, поставка прототипов;
- Система менеджмента качества сертифицирована по Международному стандарту ISO 9001;
- Лицензия ФСБ на осуществление работ с использованием сведений, составляющих государственную тайну;
- Поставка специализированных компонентов (Xilinx, Altera, Analog Devices, Intersil, Interpoint, Microsemi, Aeroflex, Peregrine, Syfer, Eurofarad, Texas Instrument, Miteq, Cobham, E2V, MA-COM, Hittite, Mini-Circuits, General Dynamics и др.);

Помимо этого, одним из направлений компании «ЭлектроПласт» является направление «Источники питания». Мы предлагаем Вам помощь Конструкторского отдела:

- Подбор оптимального решения, техническое обоснование при выборе компонента;
- Подбор аналогов;
- Консультации по применению компонента;
- Поставка образцов и прототипов;
- Техническая поддержка проекта;
- Защита от снятия компонента с производства.



Как с нами связаться

Телефон: 8 (812) 309 58 32 (многоканальный)

Факс: 8 (812) 320-02-42

Электронная почта: org@eplast1.ru

Адрес: 198099, г. Санкт-Петербург, ул. Калинина, дом 2, корпус 4, литера А.