

WOI Series

Limitless™ Wireless Operator Interface



DESCRIPTION

The Limitless™ product line extends to include wireless operator interface. With both momentary and maintained contacts, the wireless operator interface (WOI) can be used by an operator to provide indication via a pushbutton or another user-chosen operator type (i.e. 22 mm rotary switch, 22 mm key switch, etc.). The WOI Series adds a human interface device to the product-driven interfaces of Limitless™ switches and receivers – wireless control from both person and position.

FEATURES

Wireless Design

- Radio (license-free and global): WPAN 802.15.4, 2.4 GHz, point-to-point
- FCC 15, IC, ACMA & ETSI
- RoHS compliant
- EMI immunity
- Up to 305 m [1000 ft] communication range when used with a Limitless™ wireless monitor or receiver module (sold separately)
- Reliable, flexible, and secure wireless transmission
- Standard replaceable battery with ultra-low power consumption
- Direct or remote mount antenna options

Mechanical Design

- Aluminum enclosure
- IP65 sealing
- 22 mm flush, 29 mm mushroom, & 40 mm mushroom (push-pull) round pushbutton operators available
- User chosen/installed operator type is allowable
- Momentary and maintained contact options
- Design for ease of installation

The WOI Series is especially beneficial for remote monitoring applications where wiring or wire maintenance is not physically possible or economically feasible. Combining this greater flexibility with proven harsh-duty packaging can result in increased efficiencies and ease in establishing a remote operator for use in a variety of applications, including turning equipment or devices on or off, opening and closing doors/gates, stopping a production conveyor, indicating the need for service, and much more.

BENEFITS

- Enables operator indication (i.e. push button) from remote locations where wiring is too costly or not possible
- Flexibility for users to choose and install their desired operator type; i.e. 22 mm rotary switch, 22 mm key switch, etc.
- Ability to reconfigure and network multiple WOI inputs, or point-to-point with personalized addresses, which allows for adding, subtracting or relocating of Limitless™ WOI switches easily
- Offers the ability to be used in conjunction with Limitless™ switches configured on a single Limitless™ receiver
- Reduced installation/maintenance costs with no wires, conduit, strain relief, clips, connectors, connection boxes, etc.
- Eliminates issues with wire connection integrity on moving equipment
- Consumes ultra-low power to prolong battery life

POTENTIAL APPLICATIONS

Industrial

- | | |
|---------------------------|-------------------------|
| • CNC action | • Conveyors |
| • Door/Gate action | • Lifts |
| • Material handling | • Motor drives |
| • Presses | • Pumps |
| • Quality control buttons | • Specialty machines |
| • Stop/Start machinery | • Stop/Start production |
| • Valve action | |

Transportation

- | | |
|--------------------------|---------------------|
| • Agricultural equipment | • Movable machinery |
|--------------------------|---------------------|

Limitless™ WOI Series

PERFORMANCE SPECIFICATIONS

Characteristic	Measure
Series name	WOI Series
Product type	Limitless™ Operator Interface Switches
Availability	Global, license-free bands
Operating force	Momentary pushbutton: 6,2 N ±2 N [1.4 lb ±0.45 lb] Maintained pushbutton: 7,0 N ±2 N [1.6 lb ±0.45 lb]
Actuator Type	Pushbutton operators <ul style="list-style-type: none"> • 22 mm round flush momentary • 29 mm mushroom head momentary • 40 mm mushroom head maintained (push-pull); No operator option available for use with user supplied 22 mm operator and contact blocks
Actuator/Contact blocks (if user supplied)	22 mm switch design (i.e. 22mm rotary switch, 22mm key switch, etc.) /gold contact, normally open and normally closed contact blocks capable of reliably controlling a 30 mA @ 3.6 Vdc electrical load
Actuator Colors	Black, Green, Red*, Yellow * not available for the 29 mm mushroom, & 40 mm mushroom (push-pull) pushbuttons
Housing material	Powder coated aluminum
Radio	WPAN 802.15.4; 2.4 GHz
Antenna type	Direct or remote mount antenna options; Omni directional
Signal range*	Nominal 305 m [1000 ft] clear line of sight between Limitless™ WOI switch and monitor/receiver when using 2.2 dBi integral antennas
Battery	3.6 Vdc Lithium Thionyl Chloride; 2/3 AA size (Est. life >1.5 years) Manufactured by Uniwell, p/n DEV-10-0009; or Green Energy p/n ER14335M
Sealing	IP65
EMC	Latest applicable standards: EN 300 328, V1.7.1; EN 61326-1 (2006); EN 301 489-1, V1.8.1; EN 301 489-17, V2.1.1
Shock	IEC 60068-2-27; half sine, 50 g, 6 mS, 3 axis
Vibration	IEC 60068-2-6; 10-500Hz w/ 0,35 mm peak-to-peak, 58-500 Hz- 10g
Operating temperature	-25 °C to 50 °C [-13 °F to 122 °F]
Agency approvals and standards	FCC 15.247 Industry Canada RSS 210 ETSI, CE mark ACMA, C-Tick mark

* Actual range will vary depending upon antennas, cables, and site topography.

Limitless™ Wireless Operator Interface

PRODUCT NOMENCLATURE





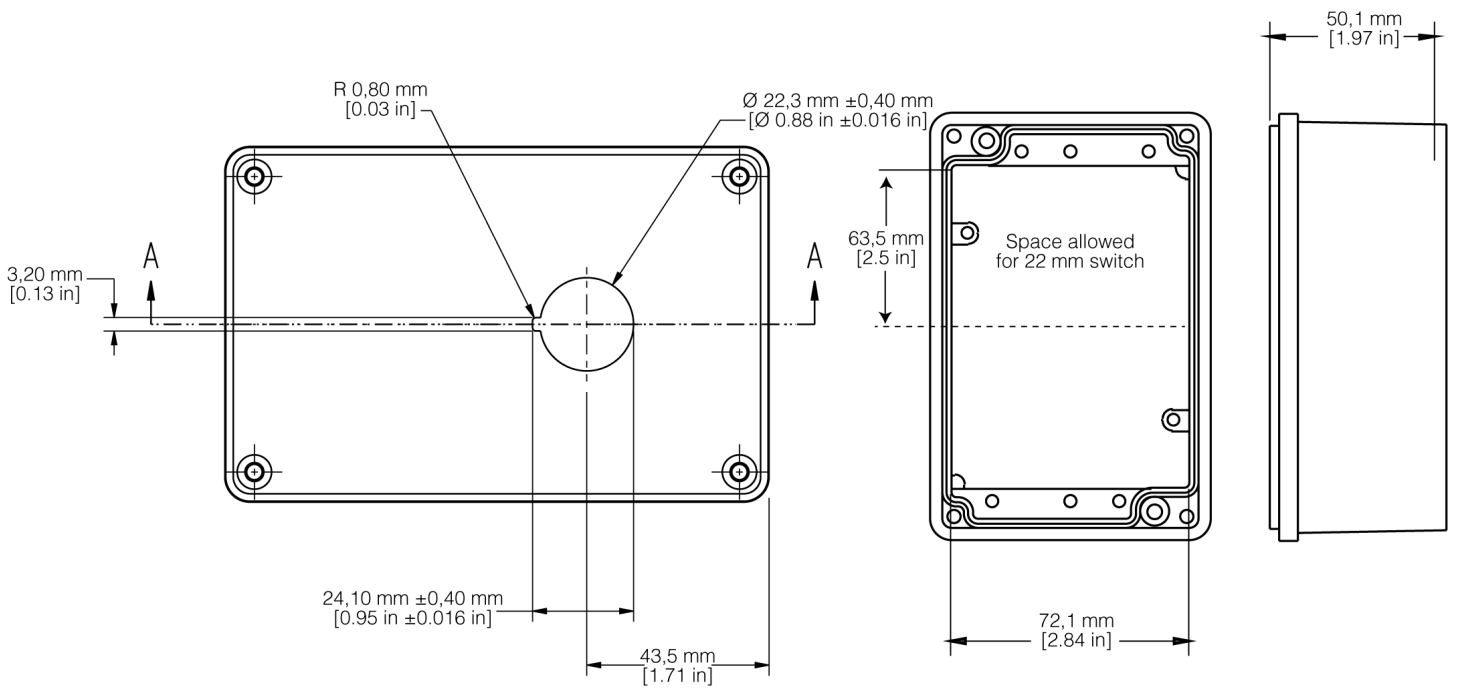



WOI	1	A	00	A	PA	G	
Module type	GEN code	RF code	Antenna type code	Country use code	Actuator type	Actuator color	Specials
WOI Series Operator Interface	1 Version 1	A 2.4 GHz; IEEE 802.15.4	00 No antenna; RP-SMA connector jack	A US, Canada Mexico	None; open hole in enclosure	None	
			02 2.2 dBi omni w/switch mount; tilt/swivel	B All other approved countries ^{1,2}	PA Pushbutton only 22 mm round flush button, momentary	B Black	
			11 0 dBi omni w/ switch mount; str. design	¹ Some countries require specific communication certifications. Contact Honeywell for existing certification information.	PB Pushbutton only ³ 29 mm mushroom head, momentary	G Green	
				² If Limitless™ devices are used on machinery that may be shipped globally, use Country Code "B".	PC Pushbutton only ³ 40 mm mushroom head, maintained/push-pull	R Red	
					³ There will be the following specific note on the "I" & "E" drawing: NOT AVAILABLE IN RED	Y Yellow	









PRODUCT DIMENSIONS



Limitless™ WOI Series

STANDARD LISTINGS

	Part number	Description
	WOI1A00APAG	Limitless™ WOI, no antenna, 22 mm round flush momentary green pushbutton, for use in US/Canada
	WOI1A00APAR	Limitless™ WOI, no antenna, 22 mm round flush momentary red pushbutton, for use in US/Canada
	WOI1A11APAG	Limitless™ WOI, 0 dBi straight antenna, 22 mm round flush momentary green pushbutton, for use in US/Canada
	WOI1A11APAR	Limitless™ WOI, 0 dBi straight antenna, 22 mm round flush momentary red pushbutton, for use in US/Canada
	WOI1A00APBY	Limitless™ WOI, no antenna, 29 mm mushroom head momentary yellow pushbutton, for use in US/Canada
	WOI1A00APCY	Limitless™ WOI, no antenna, 40 mm maintained yellow pushbutton, for use in US/Canada
	WOI1A11APBY	Limitless™ WOI, 0 dBi straight antenna, 29 mm mushroom head momentary yellow pushbutton, for use in US/Canada
	WOI1A11APCY	Limitless™ WOI, 0 dBi straight antenna, 40 mm maintained yellow pushbutton, for use in US/Canada

	Part number	Description
	WOI1A00BPAG	Limitless™ WOI, no antenna, 22 mm round flush momentary green pushbutton, for use in all other approved countries
	WOI1A00BPAR	Limitless™ WOI, no antenna, 22 mm round flush momentary red pushbutton, for use in all other approved countries
	WOI1A11BPAG	Limitless™ WOI, 0 dBi straight antenna, 22 mm round flush momentary green pushbutton, for use in all other approved countries
	WOI1A11BPAR	Limitless™ WOI, 0 dBi straight antenna, 22 mm round flush momentary red pushbutton, for use in all other approved countries
	WOI1A00BPBY	Limitless™ WOI, no antenna, 29 mm mushroom head momentary yellow pushbutton, for use in all other approved countries
	WOI1A00BPCY	Limitless™ WOI, no antenna, 40 mm maintained yellow pushbutton, for use in all other approved countries
	WOI1A11BPBY	Limitless™ WOI, 0 dBi straight antenna, 29 mm mushroom head momentary yellow pushbutton, for use in all other approved countries
	WOI1A11BPCY	Limitless™ WOI, 0 dBi straight antenna, 40 mm maintained yellow pushbutton, for use in all other approved countries

Limitless™ Wireless Operator Interface

ANTENNA OPTIONS



WAN07RSP
straight design,
direct mount
connector



WAN01RSP
straight design,
direct mount
connector



WAN02RSP
tilt & swivel design,
direct mount
connector



**WAN05RSP &
WAMM100RSP-005**
T/S, magnetic mount



WAN03RSP
flat design,
adhesive mount



WAN06RNJ
straight design,
bracket mount



WPB1
WPMM mounting
bracket



WAN10RSP
straight mobile
antenna,
magnetic mount



WAN11RSP
low-profile dome antenna,
through-hole screw mount



WAN09RSP
low-profile mobile antenna,
magnetic mount

Limitless™ WOI Series

ANTENNA CABLE OPTIONS

WCA200RNPRSP-002 Cable Assembly: 2 ft¹

WCA200RNPRSP-010 Cable Assembly: 10 ft¹



¹ use only with WAN06RNJ antenna and when extra cable is desired

WCA200RNJRSP-002 Cable Assembly: 2 feet length²

WCA200RNJRSP-005 Cable Assembly: 5 feet length²

WCA200RNJRSP-010 Cable Assembly: 10 feet length²

WCA200RNJRSP-015 Cable Assembly: 15 feet length²

WCA200RNJRSP-020 Cable Assembly: 20 feet length²

² Use when extra cable length is desired and allows connection from RP-SMA jack to RP-SMA plug

MOUNTING OPTIONS

Limitless™ Panel Mount Accessories

WAMM100RSP-005 Magnetic Antenna Mount: w/ 5 ft of cable³

WAMM100RSP-010 Magnetic Antenna Mount: w/ 10 ft of cable³



³ Use only with WAN01RSP, WAN02RSP, WAN04RSP, WAN05RSP, or WAN08RSP antennas

Warranty. Honeywell warrants goods of its manufacture as being free of defective materials and faulty workmanship. Honeywell's standard product warranty applies unless agreed to otherwise by Honeywell in writing; please refer to your order acknowledgement or consult your local sales office for specific warranty details. If warranted goods are returned to Honeywell during the period of coverage, Honeywell will repair or replace, at its option, without charge those items it finds defective. **The foregoing is buyer's sole remedy and is in lieu of all warranties, expressed or implied, including those of merchantability and fitness for a particular purpose. In no event shall Honeywell be liable for consequential, special, or indirect damages.**

While we provide application assistance personally, through our literature and the Honeywell web site, it is up to the customer to determine the suitability of the product in the application.

Specifications may change without notice. The information we supply is believed to be accurate and reliable as of this printing. However, we assume no responsibility for its use.

Find out more

Honeywell serves its customers through a worldwide network of sales offices, representatives and distributors. For application assistance, current specifications, pricing or name of the nearest Authorized Distributor, contact your local sales office. To learn more about Honeywell's sensing and control products, call **+1-815-235-6847/1-800-537-6945**, visit **www.honeywell.com/limitless**, or e-mail inquiries to **info.sc@honeywell.com**

Sensing and Control
Honeywell
1985 Douglas Drive North
Golden Valley, MN 55422 USA
honeywell.com

WARNING

MISUSE OF DOCUMENTATION

- The information presented in this datasheet is for reference only. DO NOT USE this document as product installation information.
- Complete installation, operation and maintenance information is provided in the instructions supplied with each product.

Failure to comply with these instructions could result in death or serious injury.

WARNING

PERSONAL INJURY

DO NOT USE these products as safety or emergency stop devices or in any other application where failure of the product could result in personal injury.

Failure to comply with these instructions could result in death or serious injury.

WARNING

Honeywell does not recommend using devices for critical control applications where there is, or may be, a single point of failure or where single points of failure may result in an unsafe condition. It is up to the end-user to weigh the risks and benefits to determine if the products are appropriate for the application based on security, safety and performance. Additionally, it is up to the end-user to ensure that the control strategy results in a safe operating condition if any crucial segment of the control solution fails. Honeywell customers assume full responsibility for learning and meeting the required Declaration of Conformity, Regulations, Guidelines, etc. for each country in their distribution market.

Honeywell



Компания «ЭлектроПласт» предлагает заключение долгосрочных отношений при поставках импортных электронных компонентов на взаимовыгодных условиях!

Наши преимущества:

- Оперативные поставки широкого спектра электронных компонентов отечественного и импортного производства напрямую от производителей и с крупнейших мировых складов;
- Поставка более 17-ти миллионов наименований электронных компонентов;
- Поставка сложных, дефицитных, либо снятых с производства позиций;
- Оперативные сроки поставки под заказ (от 5 рабочих дней);
- Экспресс доставка в любую точку России;
- Техническая поддержка проекта, помощь в подборе аналогов, поставка прототипов;
- Система менеджмента качества сертифицирована по Международному стандарту ISO 9001;
- Лицензия ФСБ на осуществление работ с использованием сведений, составляющих государственную тайну;
- Поставка специализированных компонентов (Xilinx, Altera, Analog Devices, Intersil, Interpoint, Microsemi, Aeroflex, Peregrine, Syfer, Eurofarad, Texas Instrument, Miteq, Cobham, E2V, MA-COM, Hittite, Mini-Circuits, General Dynamics и др.);

Помимо этого, одним из направлений компании «ЭлектроПласт» является направление «Источники питания». Мы предлагаем Вам помощь Конструкторского отдела:

- Подбор оптимального решения, техническое обоснование при выборе компонента;
- Подбор аналогов;
- Консультации по применению компонента;
- Поставка образцов и прототипов;
- Техническая поддержка проекта;
- Защита от снятия компонента с производства.



Как с нами связаться

Телефон: 8 (812) 309 58 32 (многоканальный)

Факс: 8 (812) 320-02-42

Электронная почта: org@eplast1.ru

Адрес: 198099, г. Санкт-Петербург, ул. Калинина, дом 2, корпус 4, литера А.