

Solid State Relay G3R-I/O

Compact SSRs for I/O Interface with High Dielectric Strength Requirements

- High-speed models with optimum input ratings for a variety of sensors are available.
- Input Modules and Output Modules that have the same form-factor as the G2R.
- Using a coupler approved by VDE 0884 and assuring an I/O dielectric strength of 4 kV.
- Incorporating an easy-to-see monitoring indicator.
- Approved by UL, CSA, and TÜV. ("-UTU" models)

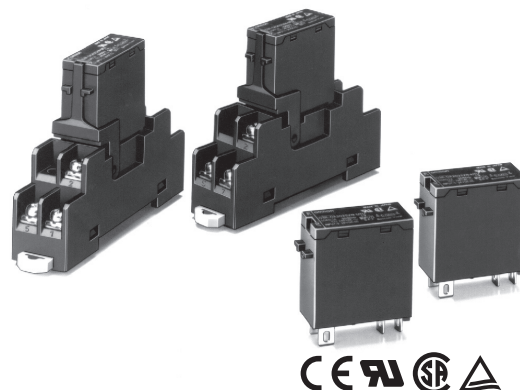

Ordering Information

To Order: Select the part number and add the desired coil voltage rating, (e.g., G3R-IAZR1SN-DC5)

Input Module

Isolation	Indicator	Response speed	Logic level		Rated input voltage	Model
			Supply voltage	Supply current		
Photocoupler	Yes	—	4 to 32 VDC	0.1 to 100 mA	100 to 240 VAC	G3R-IAZR1SN
		High-speed (1 kHz)			5 VDC	G3R-IDZR1SN
		Low-speed (10 Hz)			12 to 24 VDC	G3R-IDZR1SN-1
					5 VDC	
12 to 24 VDC						

Output Module

Isolation	Indicator	Zero cross function	Rated output load	Rated input voltage	Model
Phototriac	Yes	Yes	2 A at 100 to 240 VAC	5 to 24 VDC	G3R-OA202SZN
		No			G3R-OA202SLN
Photocoupler	—	—	2 A at 5 to 48 VDC		G3R-ODX02SN
			1.5 A at 48 to 200 VDC		G3R-OD201SN

Note: When ordering a UL, CSA and EN (TÜV) approved model, add "-UTU" to the model number as shown below:
Example: G3R-OA202SZN-UTU DC5-24.

I/O Indication

I/O module classification and AC/DC use are indicated on the mark affixed to the top of the product.

Mark indication	Specification
AC IN	Input module, AC input
DC IN	Input module, DC input
AC OUT	Output module, AC output
DC OUT	Output module, DC output

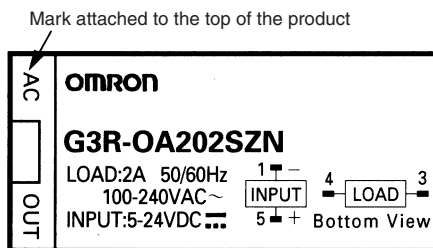

Specifications

■ Ratings (at an Ambient Temperature of 25°C)

Input Module

Input

Model	Rated voltage	Operating voltage	Input current	Must operate voltage	Must release voltage
G3R-IAZR1SN	100 to 240 VAC	60 to 264 VAC	15 mA max.	60 VAC max.	20 VAC min.
G3R-IDZR1SN	5 VDC	4 to 6 VDC	8 mA max.	4 VDC max.	1 VDC min.
	12 to 24 VDC	6.6 to 32 VDC		6.6 VDC max.	3.6 VDC min.
G3R-IDZR1SN-1	5 VDC	4 to 6 VDC		4 VDC max.	1 VDC min.
	12 to 24 VDC	6.6 to 32 VDC		6.6 VDC max.	3.6 VDC min.

Output

Model	Logic level supply voltage	Logic level supply current
G3R-IAZR1SN	4 to 32 VDC	0.1 to 100 mA
G3R-IDZR1SN		
G3R-IDZR1SN-1		

Output Module

Input

Model	Rated voltage	Operating voltage	Input current	Must operate voltage	Must release voltage
G3R-OA202SZN	5 to 24 VDC	4 to 32 VDC	15 mA max. (at 25°C)	4 VDC max.	1 VDC min.
G3R-OA202SLN			8 mA max.		
G3R-ODX02SN					
G3R-OD201SN					

Output

Model	Rated load voltage	Load voltage range	Load current (see note)	Inrush current
G3R-OA202SZN	100 to 240 VAC	75 to 264 VAC	0.05 to 2 A	30 A (60 Hz, 1 cycle)
G3R-OA202SLN				
G3R-ODX02SN	5 to 48 VDC	4 to 60 VDC	0.01 to 2 A	8 A (10 ms)
G3R-OD201SN	48 to 200 VDC	40 to 200 VDC	0.01 to 1.5 A	8 A (10 ms)

Note: The minimum current value is measured at 10°C min.

Characteristics

■ Input Module

Item	G3R-IAZR1SN	G3R-IDZR1SN	G3R-IDZR1SN-1
Operate time	20 ms max.	0.1 ms max.	15 ms max.
Release time	20 ms max.	0.1 ms max.	15 ms max.
Response frequency	10 Hz	1 kHz	10 Hz
Output ON voltage drop	1.6 V max.		
Leakage current	5 μ A max.		
Insulation resistance	100 M Ω min. between input and output		
Dielectric strength	4,000 VAC, 50/60 Hz for 1 min. between input and output		
Vibration resistance	10 to 55 Hz, 1.5-mm double amplitude		
Shock resistance	1,000 m/s ² {approx. 100G}		
Ambient temperature	Operating: -30°C to 80°C (with no icing) Storage: -30°C to 100°C (with no icing)		
Approved standards	UL File No. E64562 CSA File No. LR35535 TÜV File No. R9650094 (EN60950)		
Ambient humidity	Operating: 45% to 85%		
Weight	Approx. 18 g		

■ Output Module

Item	G3R-OA202SZN	G3R-OA202SLN	G3R-ODX02SN	G3R-OA201SN
Operate time	1/2 of load power source cycle + 1 ms max.		1 ms max.	
Release time	1/2 of load power source cycle + 1 ms max.		2 ms max.	
Response frequency	20 Hz		100 Hz	
Output ON voltage drop	1.6 V max.			2.5 V max.
Leakage current	1.5 mA max.		1 mA max.	
Insulation resistance	100 M Ω min. between input and output			
Dielectric strength	4,000 VAC, 50/60 Hz for 1 min. between input and output			
Vibration resistance	10 to 55 Hz, 1.5-mm double amplitude			
Shock resistance	1,000 m/s ² {approx. 100G}			
Ambient temperature	Operating: -30°C to 80°C (with no icing) Storage: -30°C to 100°C (with no icing)			
Approved standards	UL File No. E64562 CSA File No. LR35535 TÜV File No. R9650094 (EN60950)			
Ambient humidity	Operating: 45% to 85%			
Weight	Approx. 18 g			

Engineering Data

Load Current vs. Ambient Temperature

G3R-OA202SZN(-UTU)/OA202SLN(-UTU) G3R-ODX02SN(-UTU) (4 to 60 VDC) G3R-OD201SN(-UTU) (40 to 200 VAC)

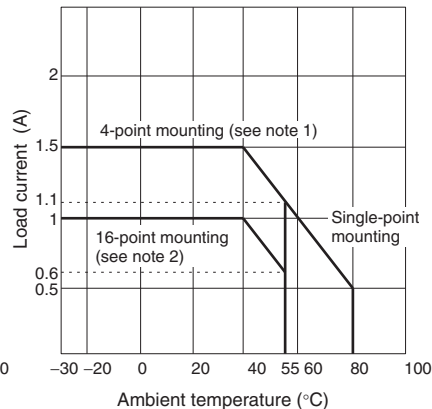
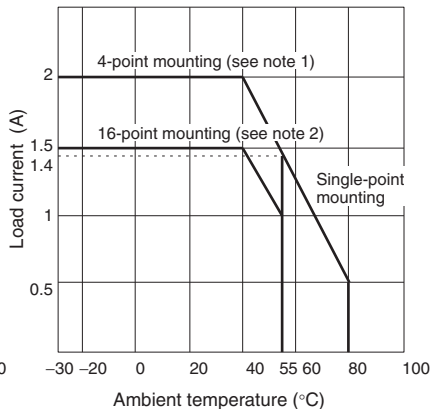
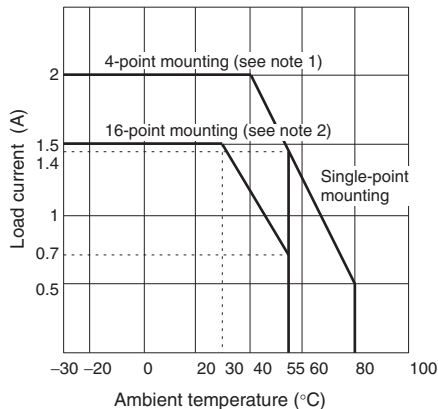

Note: 1. When G730-Z0M04-B is mounted.
 2. When G70A-Z0C16 is mounted.

Inrush Current Resistivity

Non-repetitive (Keep the inrush current to half the rated value if it occurs repetitively.)

G3R-OA202SZN(-UTU)/OA202SLN(-UTU)

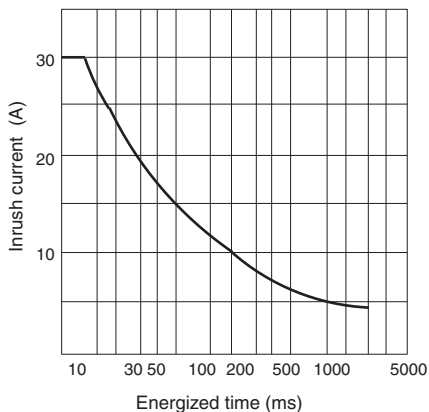

G3R-ODX02SN(-UTU)

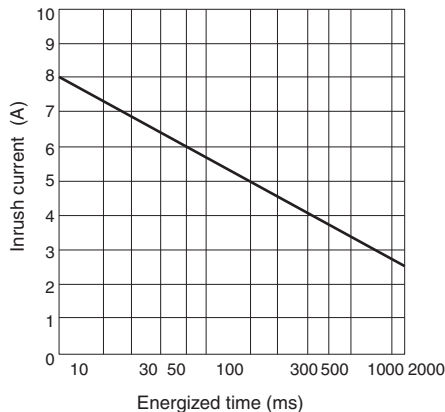

G3R-OD201SN(-UTU)

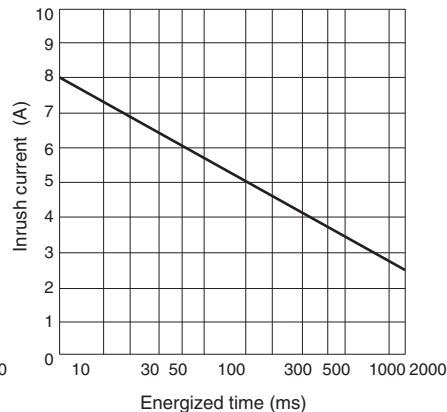

Dimensions

Unit: mm (inch)

■ G3R

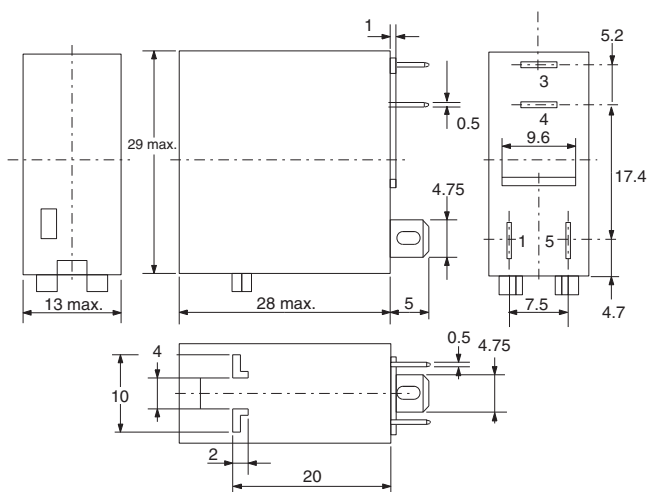

Terminal Arrangement/
Internal Connections
(Bottom View)

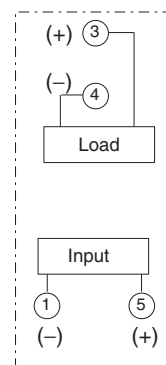

■ Connecting Sockets

P2RF-05

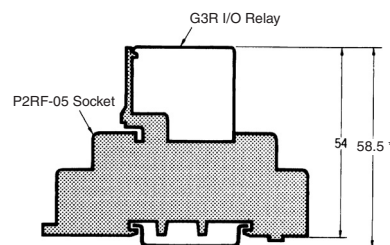
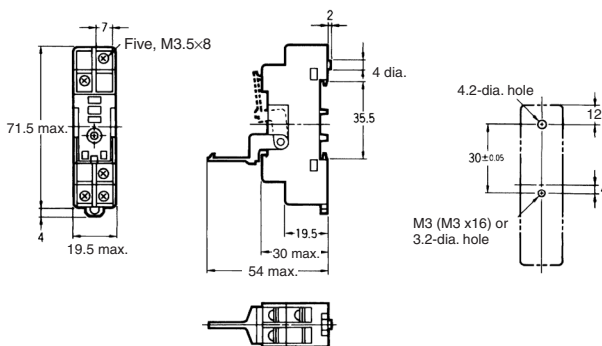
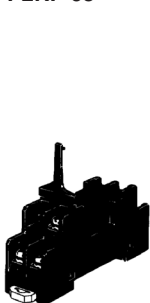

* Indicates a value when using the PFP-□N Supporting Rail. The value is 67.5 when using the PFP-□N2.

P2RF-05-E

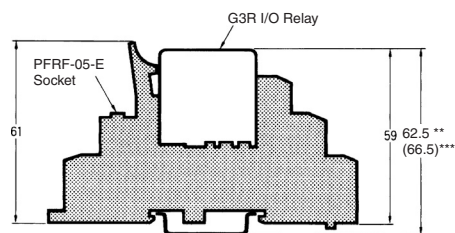
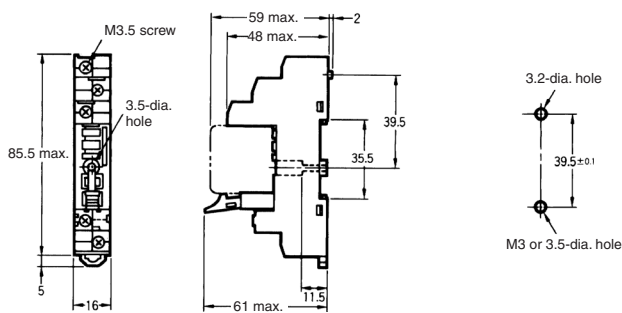
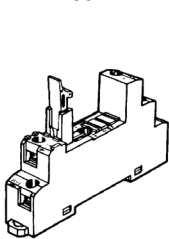

** Indicates a value when using the PFP-□N Supporting Rail with the P2RF-05-E. The value is 71.5 when using the PFP-□N2.

*** Indicates a value when using the PFP-□N Supporting Rail with the P2RF-08-E. The value is 75.5 when using the PFP-□N2.

P2R-05A

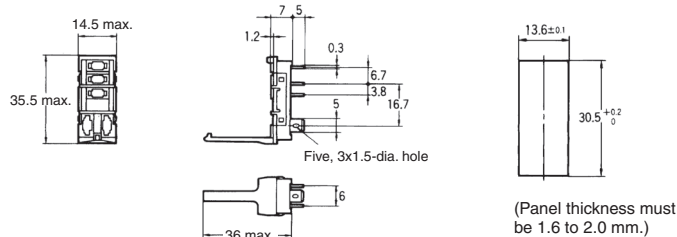

(Panel thickness must be 1.6 to 2.0 mm.)

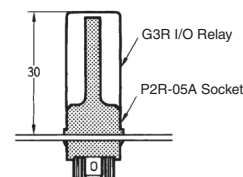

(For use when mounting in a panel or in the P2R-P mounting plate)

P2R-05P

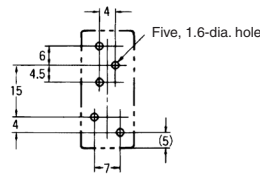
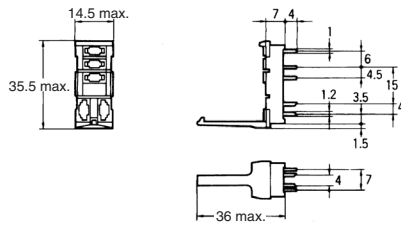

Dimensional tolerance is ± 0.1 .

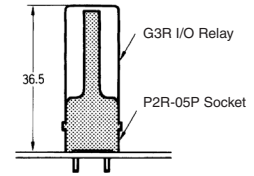

P2R-057P

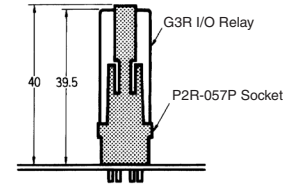
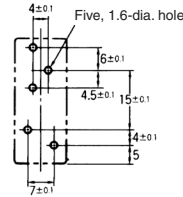
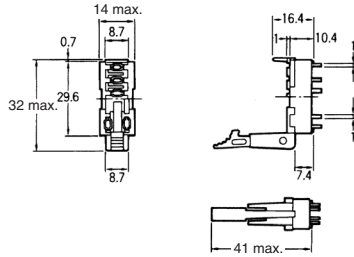
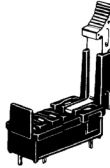

Socket Mounting Plate

Use the P2R-P Socket Mounting Plate when arranging several P2R-05A Sockets in a row.

P2R-P

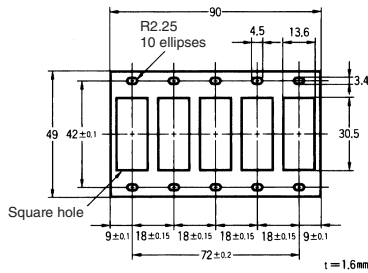

Approvals

UL Recognized (File No. E64562) / CSA Certified (File No. LR35535)

Model G3R-	Module type	Rating
IAZR1SN	Input	100 to 240 VAC
IDZR1SN	Input	5 VDC, 12 to 24 VDC
IDZR1SN-1	Input	5 VDC, 12 to 24 VDC
OA202SZN	Output	5 to 24 VDC
OA202SLN	Output	5 to 24 VDC
ODX02SN	Output	5 to 24 VDC
OD201SN	Output	5 to 24 VDC

Model G3R-	Module type	Output rating
IAZR1SN	Input	32 VDC, 100 mA (General Purpose)
IDZR1SN	Input	32 VDC, 100 mA (General Purpose)
IDZR1SN-1	Input	32 VDC, 100 mA (General Purpose)
OA202SZN	Output	264 VAC, 2 A (General Purpose)
		264 VAC, 1 A (Tungsten)
		264 VAC, 1 A FLA, 6 A LRA
OA202SLN	Output	264 VAC, 2 A (General Purpose)
		264 VAC, 1 A (Tungsten)
		264 VAC, 1 A FLA, 6 A LRA
ODX02SN	Output	60 VDC, 2 A (General Purpose)
		60 VDC, 1 A (Tungsten)
OD201SN	Output	200 VDC, 1.5 A (General Purpose)
		200 VDC, 0.75 A (Tungsten)

Precautions

■ Connection

With the SSR for DC switching, the load can be connected to either positive or negative output terminal of the SSR.

■ Protective element

Since the SSR does not incorporate an overvoltage absorption component, be sure to connect an overvoltage absorption component when using the SSR under an inductive load.

■ Precaution of Mounting Output Modules

With up to four G3R SSRs mounted closely and side by side, 2-A loads can be switched.

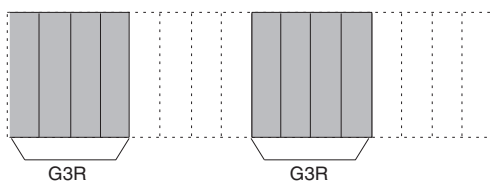

With a G3R SSRs mounted every other slot, 2-A loads can be switched.

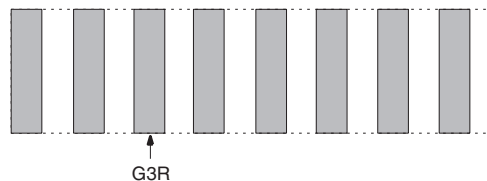

All sales are subject to Omron Electronic Components LLC standard terms and conditions of sale, which can be found at http://www.components.omron.com/components/web/webfiles.nsf/sales_terms.html

ALL DIMENSIONS SHOWN ARE IN MILLIMETERS.
To convert millimeters into inches, multiply by 0.03937. To convert grams into ounces, multiply by 0.03527.

OMRON[®]

**OMRON ELECTRONIC
COMPONENTS LLC**

55 E. Commerce Drive, Suite B
Schaumburg, IL 60173

847-882-2288

OMRON ON-LINE

Global - <http://www.omron.com>

USA - <http://www.components.omron.com>

Cat. No. X301-E-1b

09/11

Specifications subject to change without notice

Printed in USA



Компания «ЭлектроПласт» предлагает заключение долгосрочных отношений при поставках импортных электронных компонентов на взаимовыгодных условиях!

Наши преимущества:

- Оперативные поставки широкого спектра электронных компонентов отечественного и импортного производства напрямую от производителей и с крупнейших мировых складов;
- Поставка более 17-ти миллионов наименований электронных компонентов;
- Поставка сложных, дефицитных, либо снятых с производства позиций;
- Оперативные сроки поставки под заказ (от 5 рабочих дней);
- Экспресс доставка в любую точку России;
- Техническая поддержка проекта, помощь в подборе аналогов, поставка прототипов;
- Система менеджмента качества сертифицирована по Международному стандарту ISO 9001;
- Лицензия ФСБ на осуществление работ с использованием сведений, составляющих государственную тайну;
- Поставка специализированных компонентов (Xilinx, Altera, Analog Devices, Intersil, Interpoint, Microsemi, Aeroflex, Peregrine, Syfer, Eurofarad, Texas Instrument, Miteq, Cobham, E2V, MA-COM, Hittite, Mini-Circuits, General Dynamics и др.);

Помимо этого, одним из направлений компании «ЭлектроПласт» является направление «Источники питания». Мы предлагаем Вам помощь Конструкторского отдела:

- Подбор оптимального решения, техническое обоснование при выборе компонента;
- Подбор аналогов;
- Консультации по применению компонента;
- Поставка образцов и прототипов;
- Техническая поддержка проекта;
- Защита от снятия компонента с производства.



Как с нами связаться

Телефон: 8 (812) 309 58 32 (многоканальный)

Факс: 8 (812) 320-02-42

Электронная почта: org@eplast1.ru

Адрес: 198099, г. Санкт-Петербург, ул. Калинина, дом 2, корпус 4, литера А.