

ERmet[®]

Acc. To IEC 61076-4-101

2.0 mm ERmet Hard Metric Connector System

Table of Contents



2.0 mm ERmet Hard Metric Connector System Introduction	140
Product Overview	141
Complementary Components	145
2.0 mm ERmet Hard Metric Connector System	146
Comparison of 2.0 mm Connectors	146
Application Notes	148
Product Features	149
Design Requirements For Printed Circuit Boards	151
Alignment Tolerance	152
Midplane and Stacking Applications	152
Shroud Selection Information	153
Ordering Information Shroud Selection Chart	154
Mechanical Specifications and Performance	156
7-Row Electrical Performance	158
High Frequency Characteristics	158
10-Row Electrical Performance	160
High Frequency Characteristics	160
Approval Certificates, Performance Levels And Ordering Information	162
Right Angle Female Connectors Type A for Daughter Cards	163
Vertical Male Connectors Type A for Backplanes	165
Vertical Female Connectors Type A	170
Right Angle Female Connectors Type B for Daughter Cards	174
Vertical Male Connectors Type B for Backplanes	177
Vertical Female Connectors Type B	183
Right Angle Female Connectors Type AB for Daughter Cards	188
Vertical Male Connectors Type AB for Backplanes	191
Right Angle Female Connectors Type C for Daughter Cards	193
Vertical Male Connectors Type C for Backplanes	195
Vertical Female Connectors Type C	198
Right Angle Female Connectors Type D for Daughter Cards	202
Vertical Male Connectors Type D for Backplanes	204
Vertical Female Connectors Type D	206
Right Angle Female Connectors Type E for Daughter Cards	208
Verticale Male Conneactors Type E for Backplanes	210
Verticale Female Connectors Type E	212
Right Angle Female Connectors Type DE for Daughter Cards	214
Verticale Male Connectors Type DE for Backplanes	216
Right Angle Female Connectors Type F for Daughter Cards	218
Verticale Male Connectors Type F for Backplanes	220
Verticale Female Connectors Type F	222
Right Angle Female Connectors Type L for Daughter Cards	224
Verticale Male Connectors Type L for Backplanes	226
Right Angle Female Connectors Type M for Daughter Cards	228
Verticale Male Connectors Type M for Backplanes	230
Right Angle Female Connectors Type N for Daughter Cards	232
Verticale Male Connectors Type N for Backplanes	234
Shrouds Type A for Backplanes	236
Shrouds Type B for Backplanes	239
Shrouds Type C for Backplanes	243
Shrouds Type AB for Backplanes	245
Shrouds Type D for Backplanes	249
Shrouds Type E for Backplanes	251
Shrouds Type F for Backplanes	253

2.0 mm ERmet Hard Metric Connector System

Table of Contents



Right Angle Female Monoblock Modules	255
Vertical Male Monoblock Modules	257
Dust Covers For Type A, B, AB, D, E and DE	259
Coding Keys	261
Guide Pin for ERmet 10 Row Type D	262
Special Contacts for Type L, M and N	263
Modular press-fit tools for male and female connectors	264
Press-In-Tools For The Female Connectors	265
Press-In-Tools For The Male Connectors	266
Toolholder	266
3U CompactPCI® Daughter Card Layout	267
3U CompactPCI® Backplane Layout	268
6U CompactPCI® Daughter Card Layout	269
6U CompactPCI® Backplane Layout	270
9U 10-Row 2mm Daughter Card Layout	271
9U 10-Row 2mm Backplane Layout	272
IEEE 1301 Daughter Cards for IEC 61076-4-101 2mm HM Connectors	273
IEEE 1301 Backplane Layouts For IEC 61076-4-101 2mm HM Connectors	274
VME64 Extensions Daughter Card	275
VME64 Extensions Backplane	276
64 Bit CompactPCI® System Slot Pin Assignments	277
32 Bit CompactPCI® System Slot Pin Assignments	279
32 Bit CompactPCI® Peripheral Slot Pin Assignments	280
cPCI Computer Telephony P4 Pin Assignments	281
cPCI Computer Telephony Safety Classifications for J4/P4	282
cPCI Computer Telephony P5 Pin Assignments	283
cPCI Computer Telephony Safety Classifications for J5/P5	284
PXI Generic Peripheral Slot Pinout	285
PXI System Slot Pinout	286
PXI Star Trigger Slot Pinout	287
VME64x on CompactPCI® J4/P4 and J5/P5 Pin Assignments	288
Single PMC's I/O Signal Mapping to CompactPCI® 3U J2 Connector	289
PMC Mezzanine Card I/O Pin Assignments	289
IP Mezzanine Module I/O Pin Assignments	291
Bellcore Lubrication	293
Glossary Of Terminology	294
2ERNI Customer Request Form	297
Applications	300
Right Angle Male Connectors Type A for Daughter Cards	301
Right Angle Male Connectors Type B for Daughter Cards	303
Right Angle Male Connectors Type C for Daughter Cards	305
ERmet Thru Hole Reflow (THR) Female Connectors	307
CompactPCI Connectors acc. to PIGMG 2.0 Rev. 3.0	309
ERmet® Power Modules	315
Electrical and Mechanical Characteristics	316
Derating Curve and PTH Drawing	318
Right Angle Male	319
Vertical Female	325

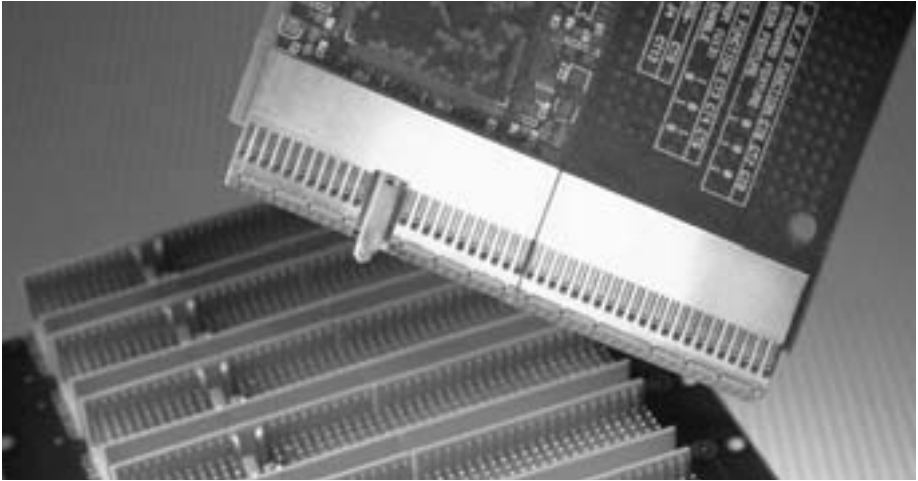

Introduction

The ERmet 2mm H.M. connector line from ERNI offers unparalleled performance and flexibility for today's high performance circuit designs. Since its introduction in 1993, this product line has expanded and now offers almost every module configuration possible in a board to backplane interconnect system. Standard and reverse configurations are available including shielded vertical females, stacking designs, stamped power connectors. This connector system has now become the standard for board to backplane applications.

The ERmet 2mm H.M. connector system has achieved widespread acceptance and popularity as the interconnect system chosen for CompactPCI. It is also widely used by OEMs serving the telecommunications and networking industry segments. It has achieved this unparalleled acceptance due to its high frequency performance, its wide selection of modular components and its cost-benefit ratio. This connector is supported by one of the industry's most comprehensive international connector standards, IEC 61076-4-101.

Whether you are developing a new backplane, a high performance CPU or I/O card or integrating a sophisticated hybrid system, ERNI has anticipated your needs. The ERNI team stands ready to partner with you to develop the most efficient solution to your design challenge.

Features

- Modular connectors with 2.0 mm signal contact pitch for backplanes and daughter cards.
- High density board to backplane connector system.
- Up to 8 signal rows plus two shield rows for optimum performance.
- Three levels of sequential mating for front or rear hot swap applications. 1.5 mm increments.
- 15 standard contacts available for any pin loading requirement.
- Complete line of complementary accessories to include stamped power connectors, color coded coding keys, latching shrouds, ground return shields, high frequency, and high power contacts.
- Superior female connector contact design provides a uniform signal path.
- Comply to the international standard IEC 61076-4-101.
- For networking, telecommunications, high performance computing and other demanding applications.

2.0 mm ERmet Hard Metric Connector System

Product Overview



ERmet 2mm H.M. connectors are a versatile, cost-effective board-to-backplane solution for today's high performance, high density applications.

The ERmet 2mm H.M. line consists of 26 different module types including matching shrouds for midplane, stacking applications, power modules, upper and lower ground return shields, coding keys.

For circuit design versatility, the connectors are offered with a selection of contacts including signal, high power, high frequency and coaxial. They are available in 50mm, 44 mm, 38 mm, and 25mm modules for end-to-end stacking without contact loss. The dual beam female contact design provides equalized signal path lengths which results in virtually identical propagation times for each contact row.

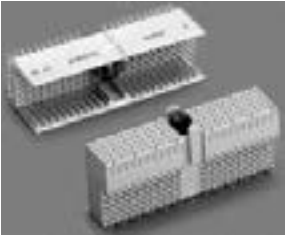

Type A Connector

- 110 signal contacts.
- 44 shield contacts.
- 50 mm long including the multifunction area for coding keys.
- Integral pre-alignment guide and polarizing pins.
- Optional locating pegs for printed circuit board (PCB) mounting.
- 3 contact lengths for sequential mating.



Type B Connector

- 125, 110 and 95 signal contacts.
- 50 shield contacts.
- 50 mm, 44 mm and 38 mm long without the multifunction area.
- 3 contact lengths for sequential mating.

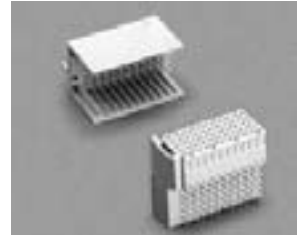

Type C Connector

- 55 signal contacts.
- 22 shield contacts.
- 25 mm long.
- For end positions only.
- Pre-alignment guide pins.
- Optional locating pegs for printed circuit board (PCB) mounting.
- 3 contact lengths for sequential mating.

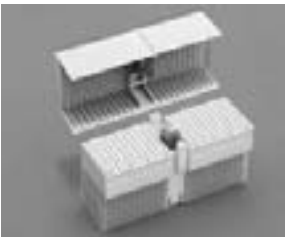

Type D Connector

- 176 signal contacts.
- 44 shield contacts.
- 50 mm long including the multifunction area for coding keys.
- Integral pre-alignment guide and polarizing pins.
- Optional locating pegs for printed circuit board (PCB) mounting.
- Positions for optional early mate ground pin.
- 3 contact lengths for sequential mating.

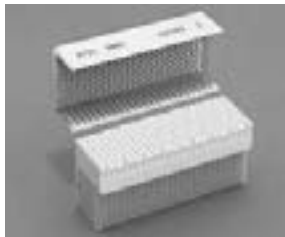

Type E Connector

- 200 signal contacts.
- 50 shield contacts.
- 50 mm long without the multifunction area.
- 3 contact lengths for sequential mating.

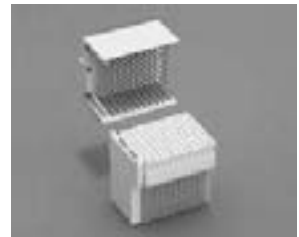

Type F Connector

- 88 signal contacts.
- 22 shield contacts.
- 25 mm long.
- For end positions only.
- Pre-alignment guide pins.
- Optional locating pegs for printed circuit board (PCB) mounting.
- 3 contact lengths for sequential mating.

2.0 mm ERmet Hard Metric Connector System

Product Overview



Type A Ground Return Shield

- Upper and lower shields for Type A connectors.
- Upper shield available integrated with female connector or as separate component.



Type B Ground Return Shield

- Upper and lower shields for the Type B female connectors.
- Upper shield available integrated with female connector or as separate component.



Type C Ground Return Shield

- Upper and lower shields for Type C and M connectors.
- Upper shield available integrated with female connector or as separate component.



Type D Ground Return Shield

- Upper and lower shields for Type D connectors.
- Upper shield available integrated with female connector or as separate component.



Type E Ground Return Shield

- Upper and lower shields for the Type E female connectors.
- Upper shield available integrated with female connector or as separate component.



Type F Ground Return Shield

- Upper and lower shields for Type F connectors.
- Upper shield available integrated with female connector or as separate component.



Type L Connector

- 6 special contact cavities.
- 50 mm long.
- Multifunction area for coding keys.
- Integral pre-alignment guide and polarizing pins.
- Optional locating pegs for printed circuit board (PCB) mounting.



Type M Connector

- 3 special contact cavities.
- 55 signal contacts.
- 50 mm long.
- Multifunction area for coding keys.
- Integral pre-alignment guide and polarizing pins.
- Optional locating pegs for printed circuit board (PCB) mounting.



Type N Connector

- 3 special contact cavities.
- 25 mm long.
- For end positions only
- Pre-alignment guide pins.
- Optional locating pegs for printed circuit board (PCB) mounting.

2.0 mm ERmet Hard Metric Connector System

Product Overview



2.0 mm ERmet



Type A Vertical Female Connector

- 110 signal contacts.
- 44 shield contacts.
- 50 mm long including the multifunction area for coding keys.
- Pre-alignment guide and integral polarizing pins.
- Optional shields.
- Extended terminals and spacers available.



Type B Vertical Female Connector

- 125, 110 and 95 signal contacts.
- 50, 44 and 38 shield contacts.
- 50 mm, 44 mm and 38 mm long without a multifunction area.
- Optional shields.
- Extended terminals and spacers available.



Type C Vertical Female Connector

- 55 signal contacts.
- 22 shield contacts.
- 25 mm long.
- For end positions only
- Pre-alignment guide pins.
- Optional locating pegs for printed circuit board (PCB) mounting.
- Optional shields.
- Extended terminals and spacers available.



Type AB25 Right Angle Female

- 125 signal contacts.
- 44 shield contacts.
- 50 mm long.
- Integral prealignment guide and polarizing pins.
- AB compatible males also available.

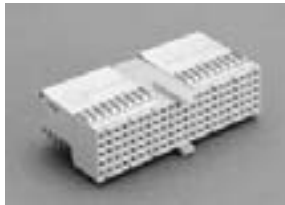

Type AB22 Right Angle Female

- 110 signal contacts.
- 40 shield contacts.
- 44 mm long.
- Integral prealignment guide and polarizing pins.
- AB compatible males also available.

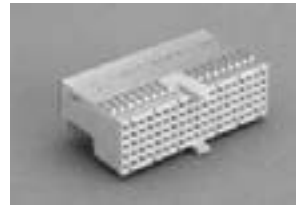

Type AB19 Right Angle Female

- 95 signal contacts.
- 32 shield contacts.
- 38 mm long.
- Integral prealignment guide and polarizing pins.
- AB compatible males also available.



Type DE Right Angle Female

- 200 signal contacts.
- 50 shield contacts.
- 50 mm long.
- Integral prealignment guide and polarizing pins.
- DE compatible males also available.

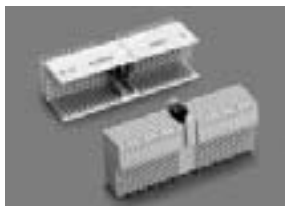

Connector Coding System

- Up to 70 unique male and female coding keys.
- For use in the multifunction center of the Type A, D, L and M male or female connectors.
- Low cost, industry standard design.
- Easy snap-in installation – no epoxy adhesive required.
- Bright colors for quick visual identification conform to industry standard.
- Crush resistant construction, exceeds IEC requirements.



2.0 mm ERmet Hard Metric Connector System

Product Overview



Type D Vertical Female Connector

- 176 signal contacts.
- 44 shield contacts.
- 50 mm long including the multifunction area for coding keys.
- Pre-alignment guide and integral polarizing pins.
- Optional shields.



Type E Vertical Female Connector

- 200 signal contacts.
- 50 shield contacts.
- 50 mm long without a multifunction area.
- Optional shields.



Type F Vertical Female Connector

- 88 signal contacts.
- 22 shield contacts.
- 25 mm long.
- For end positions only
- Pre-alignment guide pins.
- Optional shields.

2.0 mm ERmet Hard Metric Connector System

Complementary Components

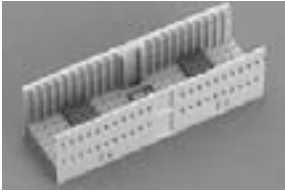

Type A Shroud

- 4 heights for printed circuit boards (PCBs) 1.6 to 6.0 mm thick.
- 50 mm and 38 mm long.
- Multifunction area for coding keys.

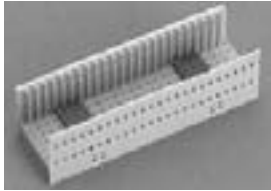

Type B Shroud

- 4 heights for printed circuit boards (PCBs) 1.6 to 6.0 mm thick.
- 50 mm, 44 mm and 38 mm long.



Type C Shroud

- 4 heights for printed circuit boards (PCBs) 1.6 to 6.0 mm thick.
- 25 mm long.
- For end positions only.

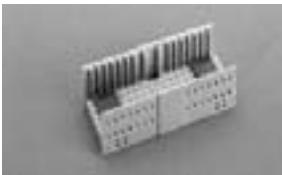

Type AB 19 & AB 25 Shroud

- 38 mm and 50 mm respectively.
- Integral pre-alignment and guide pins.
- 4 heights for printed circuit boards (PCBs) 1.6 to 6.0 mm thick.



Type AB 22 Shroud

- 44 mm long.
- Integral pre-alignment and guide pins.
- 4 heights for printed circuit boards (PCBs) 1.6 to 6.0 mm thick.

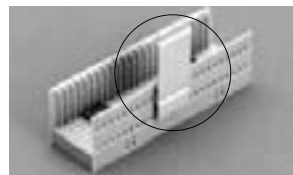

Optional Latch Arm

- Can be added to standard ERmet shroud body.
- Spring action latch.
- Easy installation, no tools required.



Monoblock Modules

- Male and Female monoblock modules.
- Optional integrated coding keys for 3.3V, 5.0V or Telecom applications.
- Multifunction area for coding keys.
- Available in a variety of configurations 94 or 100 mm long.



Male & Female Power Module

- Closed entry female connector for backplane.
- 3 pin levels for sequential mating.
- 8 ampere, per contact.
- Pressfit, flat rock assembly.

2.0 mm ERmet Hard Metric Connector System

Comparison of 2.0 mm Connectors



A 2.0 mm Connector For CompactPCI Needs To Be Different. Here's Why.

When you're choosing a 2.0 mm connector for your product, it pays to give your choice a little extra thought. Just knowing a connector is a 2.0 mm connector is not enough – there are really three distinctly separate and non-intermateable connector lines. They are the Futurebus style, the HDM style and the Hard Metric style, such as the ERmet 2mm H.M. from ERNI for CompactPCI architecture.

All three connector systems use a 2.0 mm grid and are offered in modular formats, but there the similarity ends. Each line has different printed circuit board hole sizes, contact sizes, shield configurations, keying methods and electrical characteristics. In short, there are very few similarities beyond the 2.0 mm grids they share.

All three 2.0 mm connector designs consist of multi-row pin headers on the backplane, right angle female connectors on the daughter card and a 2.0 mm grid spacing. One immediate difference is in terminal area design. The HDM style has exposed terminals on the right angle daughter card female connector, while the Futurebus and Hard Metric designs have encapsulated terminals. The 5+2 row Hard Metric backplane connector is 3.0 mm more narrow than the 5+2 row Futurebus connector. The 7 (5+2) row Hard Metric connector is more narrow even than the 6 row HDM connector. The Hard Metric design preserves more space on the backplane for components that must be placed between the connectors.

The mating distances also differ between the three product lines. Mating distance is measured from the rear edge of the daughter card to the front surface of the backplane when the daughter card is fully seated. The Futurebus mating distance is 10 mm, while the mating distance for both Hard Metric and HDM is 12.5 mm. The 12.5 mm measurement is important because it matches the mating distance of the established DIN 41612 connectors and the 2.5 mm IEC 61076-4-100 connector.

Matching mating distances allows industries that use Euro-card packaging (IEC 273 or IEEE 1101 or 1101.10) to build systems that combine the popular 96 pin DIN connectors and the newer Hard Metric and HDM connectors. This supports legacy architectures while allowing the addition of new features that require the greater signal density of 2.0 mm connectors. The VME64 Extensions committee chose the Hard Metric connector system for the P0/J0 connector because of this advantage.

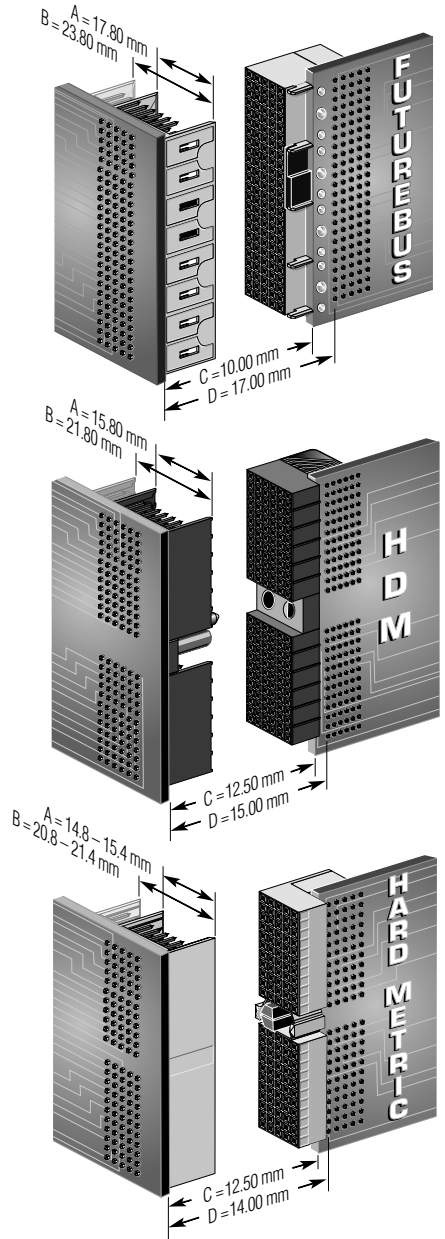

*Trademark of Teradyne Corporation

ERmet 2mm H.M. Connectors

2.0 mm ERmet Hard Metric Connector System

Comparison of 2.0 mm Connectors



Design Criteria	Connector Lines		
	HDM™	Futurebus	ERNI Hard Metric 5+2/8+2
General Specification	Proprietary	IEC 1076-4-104	IEC 61076-4-101
Number of Rows (Signal and Ground)	6*	5+2	5+2/8+2
Total Contacts Per Linear Inch	76	88	88/127
Number of Standard Modules	3	7	6/15
Width of Male Housing	15.8 mm	17.8 mm	15.4 mm – 21.4 mm
Distance from Daughter Card Edge to Row A	2.50 mm	7.00 mm	1.50 mm
Mated Distance from Backplane Front to Row A	15.0 mm	17.0 mm	14.0 mm
Signal Mating Levels / Step Distance	3 levels, 0.50 mm each	5 levels, 0.75 mm each	3 levels 1.50 mm each
EMI Shielding	Yes	Yes ⁺	Yes
Extended Guidance Features	See footnote ⁺⁺⁺	Add-On Module ⁺	Integrated
Coding Locations	See footnote ⁺⁺⁺	Integrated	Integrated
Coding Combinations Per Location	8	3	70
Reverse Connector Configuration Vertical Male	Yes	Yes	Yes
Standard Connector Configuration Vertical Female	Yes	Yes ⁺	Yes ⁺
Power Contact Modules	Yes	Yes	Yes
Coaxial Contact Modules	Yes	Yes	Yes
Maximum Contact Resistance of Mated Pair	40 mΩ	50 mΩ	20 mΩ
Propagation Delay (max.)⁺⁺	235 ps	210 ps	135 ps/190 ps
PCB Plated Hole Size	0.70 mm	0.70 mm	0.60 mm
Press-Fit	Daughter Card	Yes	Yes
Termination	Backplane	Yes	Yes

* Shield Pins Implemented Through Signal Pins

+ Not Defined in (IEC) Specification

++ Published Industry Test Results

+++ Integrated in Header and add-on module for female

2.0 mm ERmet Hard Metric Connector System

Application Notes



The ERmet 2mm H.M. connector system now consists of two basic signal module configurations. The original 5+2 design and the newer 8+2 design for higher pin count requirements. Both connector systems consist of a daughter card mounted, right angle female connector featuring the high performance, low skew patented ERmet leaf contact design and a versatile vertical male header mounted on the backplane. Additionally, this arrangement is particularly effective for midplane application and makes sequential mating easy.

ERNI can provide 15 standard pins in any row or position required for your design. This allows for three levels of sequential mating in both the front and rear of the backplane, as well as two shorter terminal lengths for applications which don't require rear feed through pins. For midplane and rear I/O applications, ERNI offers complementary 2.0 mm shrouds, vertical female connectors and latch accessories which are used in conjunction with the long terminal lengths (R1, R2 and R3).

Specific contact loading configurations have already been defined for standard applications and special needs like live insertion on CompactPCI. However, to specify a custom loading configuration, use the ERNI customer request forms located in the back of the catalog. A form is provided for the 5+2 configuration and another form is available for the 8+2 configuration.

Features

- 3 step lengths in 1.5 mm increments ensure dependable sequential mating.
- Both front and rear mating areas meet the same IEC performance level.
- 15 pin lengths defined by IEC 61076-4-101.
- Long terminal contacts (R1, R2 and R3) require the use of rear shrouds.

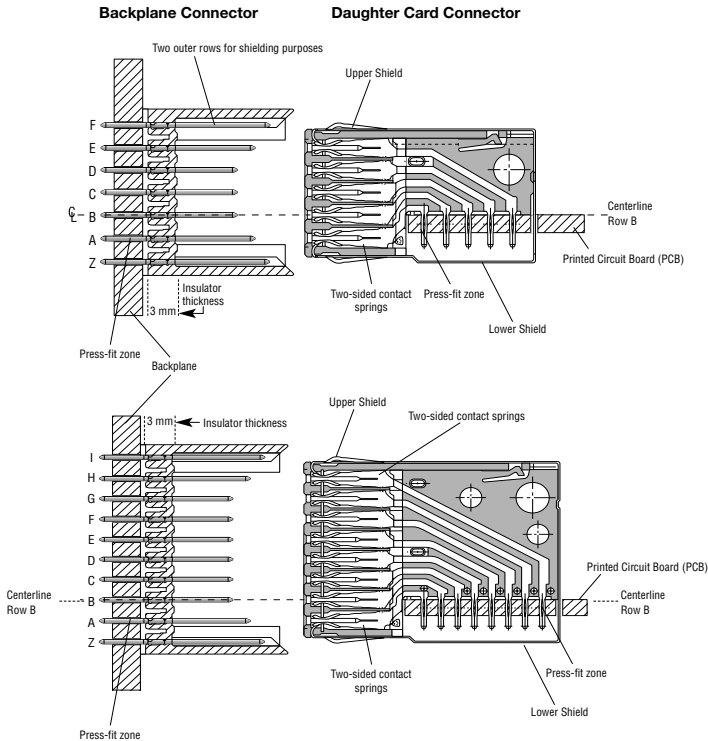

2.0 mm ERmet Hard Metric Connector System

Product Features



2.0 mm ERmet

AB Alignment Option (features)

The IEC 61076-4-101 connector standard only provides for connector Types A, B, C, D, E, F, L, M and N. Many customers require a connector with the density of a Type B (25 columns) and with the pre-alignment guide pins of the Type A, D, L and M connectors. This became a particular issue within the CompactPCI computer architecture for rear plug in applications where only B connectors were being used. The problem is that if a plug in card only utilizes Type B connectors, the cards will not have adequate vertical alignment even in the most carefully constructed subrack. The result can be pin stubbing and ultimately serious damage to both the backplane connectors and the female connectors on the daughter cards. For our customers who need a solution to this situation or who need the additional 15 pins that a Type B connector provides, but who also need the vertical alignment that the pre-alignment guide pins afford, ERNI has developed the Type AB connector. This new AB design, which does not allow for coding keys, is now required for rP3 and rP5 shrouds by the current draft PICMG Core specification (draft 3.0).



Coding Keys

CompactPCI® supports both conventional 5.0 V logic and 3.3 V logic. To prevent damage to the system resulting from incorrect insertion of cards with differing logic, coding keys are snapped into the multifunctional area of the male and female connector. This is done with the use of a plastic tool after the connector has been pressed in. The unique, bright color of the coding pairs allows for quick and easy visual identification and differentiation. For the 5.0 V logic, CompactPCI® use brilliant blue coding keys, 3.3 V logic use cadmium yellow and Telecom applications use strawberry red. The IEC 61076-4-101 standard defines a unique configuration and color for 70 different coding keys. The ERNI design has special integral supports that exceed the IEC requirements.

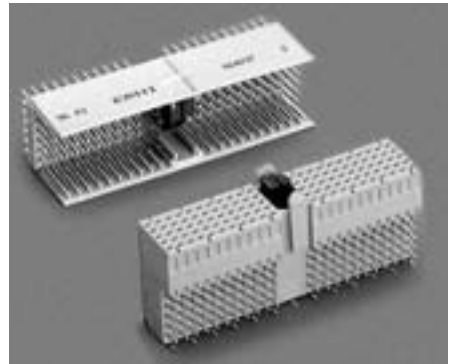

2.0 mm ERmet Hard Metric Connector System

Product Features



Male Contact Range

The ERmet 2mm H.M. Connector System has one of the longest wipe areas of any connector system as defined in IEC 61076-4-101. This ensures reliable contact mating even under adverse mating conditions. Features include:

- 2.5 mm minimum wipe length for all three contact lengths.
- The required wipe length for rear applications may be achieved by selecting the proper rear shroud height for the backplane thickness.
- IEC standardization completely defines tip blade and contact geometry, thus ensuring intermatability.

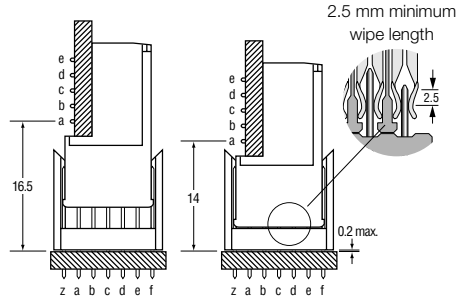

Relation To IEEE 1101.10 And IEC 297.3

The ERmet 2mm H.M. Connector System has been chosen by the PICMG for the CompactPCI bus architecture and the VITA Standards Organization for the VME64 Extensions, PO/JO connector. Both of these applications require this connector to be used in 0.8" wide slots in accordance with IEC 297.3 and IEEE 1101.10 mechanical chassis requirements. This chassis system defines the daughter card location within the card slot, relative to the interboard separation planes. When the ERmet Connector System is used within such a chassis system, the dimensions shown in the drawing will be observed. ERNI has designed the lower shield to

avoid any interference with the interboard separation plane. This ensures that the daughter card and shield assembly will not snag or interfere with high components in the adjacent slot during installation or removal.

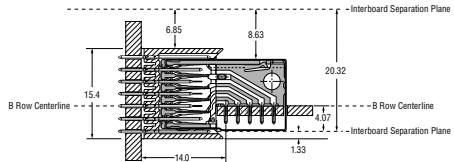

Male Contact Selection Options

The ERmet 2mm H.M. Connector System offers 15 standard contact lengths that utilize the proven pressfit assembly technique. Within the 15 contact lengths are 3 mating levels, achievable on both the plug-in and rear I/O side. Note you always keep 1.5 mm spacing between levels, for enhanced sequential mating.

On the plug-in side, the 3 contact levels are: 8.2 mm, 9.7 mm and 11.2 mm. On the rear I/O side there are 5 pressfit terminal length options: P1, P2, R1, R2, and R3. The P1 and P2 terminal lengths are for standard backplane applications with terminal lengths of 3.7 mm and 4.5 mm respectively. The R1, R2 and R3 terminal lengths are for rear I/O applications with lengths of 13.0 mm, 14.5 mm and 16.0 mm respectively. The optimum terminal length is determined by the printed circuit board thickness, rear shroud height and the desired mating level.

For contact plating information, refer to the Mechanical Specifications. To specify custom loading configurations, use the ERNI Customer Request Form.

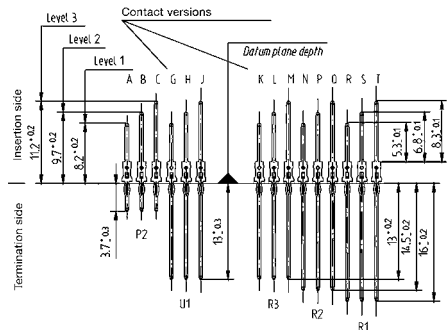



Compliant Pressfit Pins

The ERmet 2mm H.M. connector line utilizes the proven pressfit assembly method. This design was chosen because it is an efficient assembly method that offers a number of benefits over soldering including higher reliability, easier inspection and reparability, and easier installation. In addition, the pressfit method avoids exposing the high layer count printed circuit boards (PCBs) to the additional thermal stress of soldering.

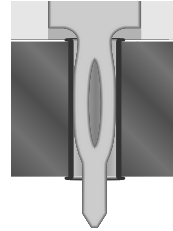

Design Requirements For Printed Circuit Boards

Plated Through-hole For Pressfitting Signal Contacts, Power Contacts And Shielding Contacts

All ERmet 5+2 row and 8+2 row signal contacts are pressfit. In addition, the bladed ERmet power connectors are also pressfit and share the same board plated hole requirements as the male and female signal connectors. The ERmet 2mm H.M. Connectors have been used successfully with reflowed tin-lead, plated tin-lead, immersion tin, organic coatings over bare copper and immersion gold hole plating regimes. The hole recommendations and press in force information shown in this catalog are for reflowed tin-lead and plated tin-lead. Additional test data for other hole plating regimes are available through customer service.

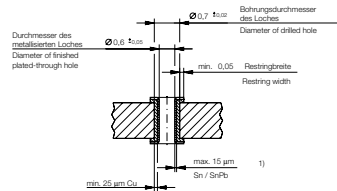

Plated Through-hole For Pressfitting High-current Contacts (Special Contacts For Modules L, M And N)

The ERmet Type L, M and N connectors have provisions for high frequency coaxial and high current circular contacts. These contacts have a variety of different plated through-hole requirements. For these, please consult ERNI Customer Service. However, ERNI does offer both 20 Amp and 40 Amp high power pressfit contacts for the L, M, and N connectors, which have the specific plated through-hole requirements shown to the right.

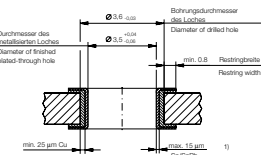
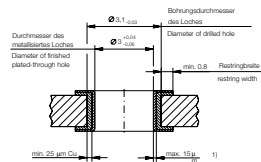

Maximum Circuit Density

The dense ERmet 2.0 mm grid spacing utilizes a 0.6 mm plated through via. This via diameter, together with an appropriate plated annular ring, leaves a 1.0 mm minimum space between adjacent annular rings for trace routing. This space allows for either two equally spaced conductor traces of 0.2 mm (.008") wide or three equally spaced conductors 0.14 mm (.006") wide, as shown in the drawing to the right. This layout can be used to bus two or three rows of the connector on each layer respectively. Many designers bus each row on a separate layer with a ground or power layer between for best signal integrity.

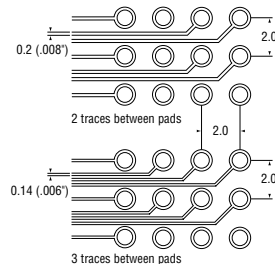



Alignment Tolerance

The pre-alignment pins ensure accurate alignment, eliminating the possibility of pin stubbing on the female insulator. When modules with the pre-alignment feature are used, the following mating tolerances can be accommodated:

- Up to 2.0 mm of vertical or horizontal misalignment.
- Up to 2 degrees of vertical or horizontal angular inclination.

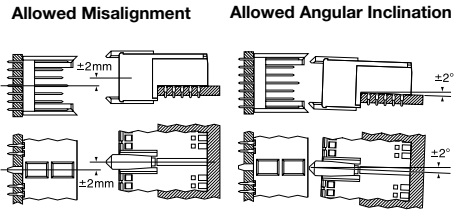

Midplane and Stacking Applications

Midplane – inline

The most common configuration for mid plane application: is to have a rear shroud over long terminals. The rear shroud is oriented so that the shroud's "a" row lines up with the "a" row of the male connector on the front side of the backplane. In this configuration, the card guides in the front of the backplane line up exactly with those behind the backplane.

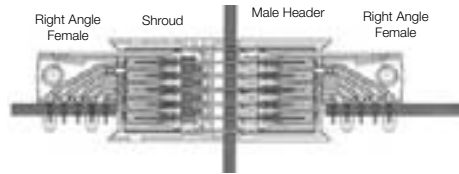

Midplane – out of line

This less common configuration has the "a" row of the shroud aligned with the "e" row of the male connector on the front side of the backplane. In this configuration, the card that plugs into the rear side has the same appearance as the board that plugs into the front side of the backplane. This usually requires a more complex card guide arrangement than the inline configuration.

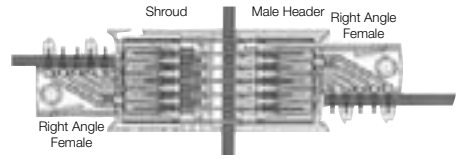

Parallel stacking

This configuration has a vertical female connector on a mezzanine board mating into a rear shroud on the rear of a backplane. This is a very popular method often used to connect two or more slots with a PCB which is parallel to the backplane. This is a common solution for switched fabrics such as Raceway or for modular dedicated bused lines such as a special processor to board memory bus. The ERmet vertical female is also available with long tails to allow two levels of stacking. The ERNI vertical female has shields so all male pins can be contacted. Vertical females with long terminals are available for additional levels of stacking.

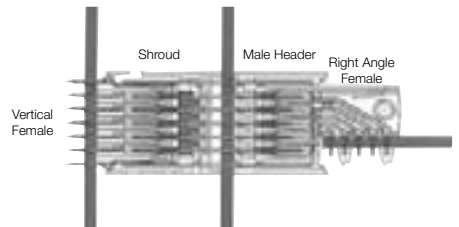

2.0 mm ERmet Hard Metric Connector System

Shroud Selection Information



After the backplane has been designed and its final overall thickness is determined, it is often challenging to select the proper shroud. Furthermore, a design may specify sequential mating in the rear which requires several different terminal lengths.

To accommodate a wide range of backplane thicknesses and up to 3 rear mating levels, ERNI offers shrouds with 4 different base thicknesses. Which base thickness you select depends on both the backplane thickness and the number of terminal lengths you need. Note that due to the extremely long contact wipe length (2.5 mm), several different combinations of pin terminal lengths and shroud base thicknesses may be used to achieve the same functional result. The chart at right shows for each of the four shroud base thicknesses, which connector terminal lengths (R1, R2 or R3) may be used for any specific backplane thickness (1.5 mm to 8.0 mm).

Examples:

- For a backplane thickness of 2.5 mm and the need to accommodate all three rear mating lengths (terminals R1, R2 and R3), a shroud base thickness of 6.1 mm must be used.
- With a 5.0 mm thick backplane and a shroud with a 5.3 mm base thickness, only the R1 and R2 terminal length pins may be used. The R3 terminal would be too short to ensure the proper wipe length for reliable mating.
- With a 3.0 mm thick backplane and a shroud with a 5.3 mm base thickness any R1, R2 and R3 terminal length pin may be used.

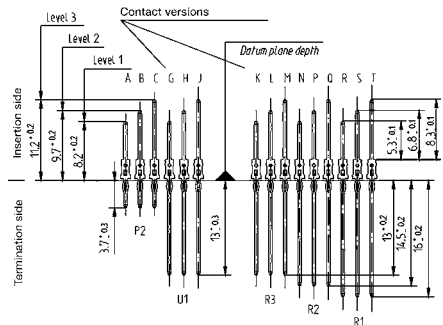
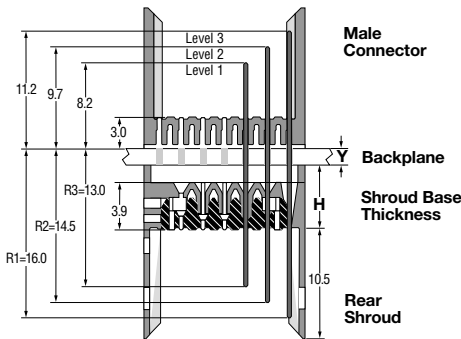
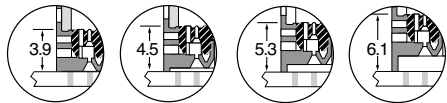
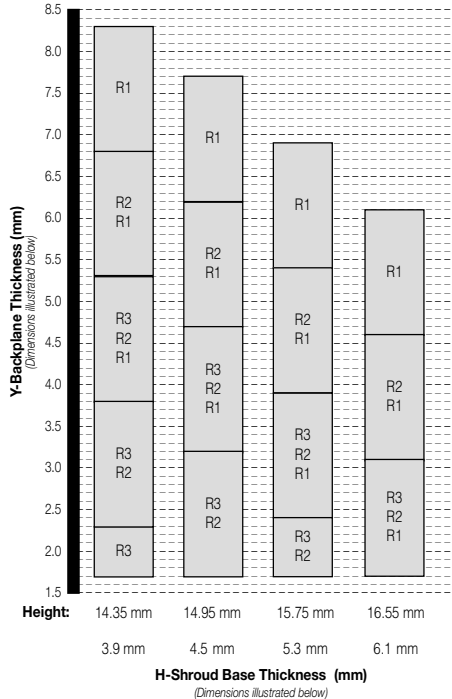



Ordering Information Shroud Selection Chart

Description	Base Thickness (mm)	Length (A) (mm)	Shroud Part #	Tool for Press* Assembly
Type A25 Shroud CompactPCI® rP1 and rP4 positions	3.9	49.9	114436	914070
	4.5	49.9	054795	914070
	5.3	49.9	054794	914070
	6.1	49.9	054793	914070
Type A19 Shroud	3.9	37.9	NA	914079
	4.5	37.9	923109	914079
	5.3	37.9	923108	914079
	6.1	37.9	923107	914079
Type AB25 Shroud	3.9	49.9	114482	914690
	4.5	49.9	114483	914690
	5.3	49.9	114484	914690
	6.1	49.9	114485	914690
Type AB22 Shroud CompactPCI® rP2 and rP5 positions	3.9	43.9	114425	914691
	4.5	43.9	114426	914691
	5.3	43.9	114427	914691
	6.1	43.9	114428	914691
Type AB19 Shroud CompactPCI® rP3 position	3.9	37.9	114487	914692
	4.5	37.9	114488	914692
	5.3	37.9	114489	914692
	6.1	37.9	114490	914692
Type B25 Shroud	3.9	49.9	114437	914069
	4.5	49.9	054797	914069
	5.3	49.9	054798	914069
	6.1	49.9	054799	914069
Type B22 Shroud	3.9	43.9	114619	914083
	4.5	43.9	064692	914083
	5.3	43.9	064693	914083
	6.1	43.9	064694	914083
Type B19 Shroud	3.9	37.9	114618	914084
	4.5	37.9	064622	914084
	5.3	37.9	064623	914084
	6.1	37.9	064624	914084
Type C11 Shroud	3.9	24.55	114438	914068
	4.5	24.55	064172	914068
	5.3	24.55	064171	914068
	6.1	24.55	064170	914068
Tool for Manual Assembly	-	-	064202	-
Latch Arm	-	-	064219	-
Replacement Locking Wafers	-	-	-	054521

Dimensions shown are for reference purposes only. All dimensions are in millimeters (mm) unless otherwise noted.

*The tools are the same tools used to pressfit the equivalent male connectors. The tools listed will only accommodate pins extending no more than 8.7 mm from the inside floor of the shroud. Calculated as follows: $[8.7 \text{ mm} > 16.0 \text{ mm} - (\text{BP thickness (mm)} + \text{shroud base thickness (mm)})]$



Connector System Modularity And Configuration

Modularity

The ERmet 2mm H.M. connector has been designed in accordance with IEC 61076-4-101, with eleven basic connector types: A, B, AB, C, D, E, DE, F, L, M and N. These connectors can be assembled end to end in a great variety of combinations but certain guidelines must be followed: You cannot mix 5+2 and 8+2 versions except under some very special situations.

Type B connectors cannot be used alone. A Type B connector must be used in conjunction with a module containing a pre-alignment guide such as connector types A, AB, C, L, M or N.

Type E connectors cannot be used alone. A Type E connector must be used in conjunction with a module containing a pre-alignment guide such as connector types D, DE or F.

Type C, N and F connectors must be assembled at the lower end of a connector stack.

Each end of the connector is designed so that the modules "nest" together. This provides additional support for the side walls and makes for a very neat appearance.

When shrouds are used on the rear side of a backplane, care must be taken to align the shrouds properly. The correct orientation will depend upon the configuration of the rear plug in cards. For most applications following the "inline" configuration, the rear shrouds will have the convex end detail facing down which is opposite to the arrangement depicted in the detailed drawing on this page. The "a" row of the shroud will match the "a" row of the male connector.

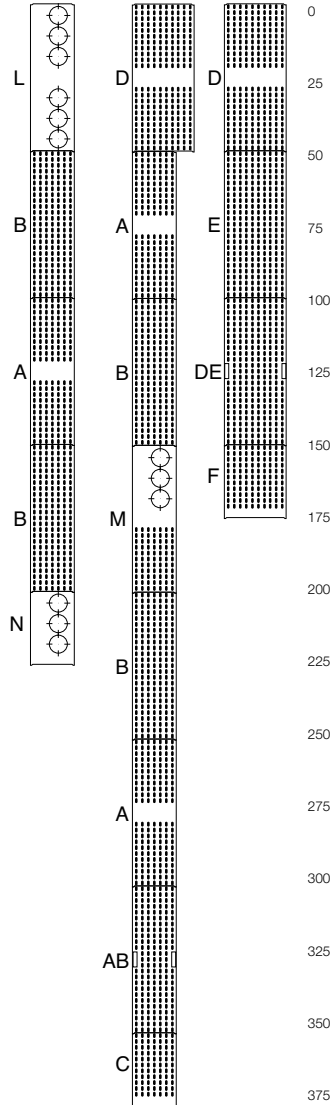

Male Connector Stacking And Connector End Details

The ERmet 2mm H.M. Connector System is a modular system designed to be assembled on a 2.0 mm grid. The connectors are designed with a unique locking feature which ties the sidewalls together. This ensures that any stress is shared across an entire connector stack when assembled as a group. The connector's convex top end and concave bottom end fit together, maintaining the dense 2.0 mm grid. The bottom of the VME64 Extensions JO connector is the one exception. It is molded flat across as it is not designed for modular stacking and would otherwise interfere with the DIN 41612 connectors. It can be used in a modular stacking configuration but will not benefit from interlocking sidewalls.

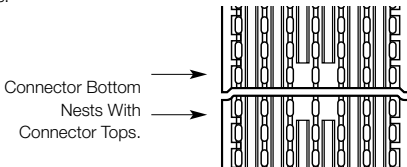

Combined Stack Height in mm

2.0 mm ERmet Hard Metric Connector System

Mechanical Specifications and Performance



General Connector Specifications

Connector Pitch		2.0 mm
Temperature Range		-55°C to +125°C
Performance level 3 per 61076-4-101		≥ 50 mating cycles
Performance level 2 per IEC 61076-4-101		≥ 250 mating cycles
Performance level 1 per IEC 61076-4-101		≥ 500 mating cycles
Pressfit pin insertion (male or female)	0.55 mm hole	36 Newtons (N) typical
	0.65 mm hole	25 Newtons (N) typical
Contact Normal Force		0.8 Newtons (N)/contact
Insulation Resistance IEC 512-2 Test 3a	Contact	10 ⁴ MΩ min @ 100DC
	Shield	10 ⁴ MΩ min @ 100 DC
Mating and with drawal force	Contact	n x 0.75 Newtons (N) maximum (n=number of contacts)
per IEC 512-7, Test 13a	Ground pin to shield	n x 1 Newtons (N) maximum (n=number of contacts)
Withdrawal force per contact IEC 512-7, Test 16e	Contact	0.15 Newtons (N) minimum
	Ground pin to shield	0.15 Newtons (N) minimum
Contact insertion force (per pin) IEC 352-5 paragraph 3.2.2.2		36.3 Newtons (N) average (male or female)
Flammability		UL 94 V-0
Hole requirements for daughter card and backplane		0.6 mm ± 0.05 mm after plating
Contact Resistance per IEC 512-2, Test 2a		20 mΩ maximum

Male Contact and Housings

Housing Material (8+2) and (5+2)		PBT 30% glass filled
CTI value per IEC 112		CTI 250 - 399
Contact Material		Phosphor bronze
Contact Plating/Performance Level P1, P2	Contact area	Gold plated
	Compliant area	Sn
	Rear terminal	Sn
Contact Plating/Performance Level R1, R2, R3	Contact area	Gold plated
	Compliant area	Sn
	Rear terminal	Gold plated

Right Angle Female Contact and Housings

		Type 1	Type 2
Housing Material (8+2)		LCP 30% glass filled	n/a
Housing Material (5+2)		LCP 30% glass filled	PBT 30% glass filled
Wafer (8+2) and (5+2)		PBT 30% glass filled	PBT 30% glass filled
CTI value per IEC 112		CTI 175	CTI 250 - 399
Contact Material		Phosphor bronze	
Contact Plating/Performance Level	Contact area	Gold plated	
	Compliant area	Sn	
Contact Normal Force		0.8 Newtons (N)/contact	

Vertical Females

Wafer (8+2) and (5+2) Material		LCP 30% glass filled
CTI value per IEC 112		CTI 175
Contact Material		Phosphor bronze
Contact Plating/Performance Level	Contact area	Gold plated
	Compliant area	Sn
	Extended Terminals	Gold plated

2.0 mm ERmet Hard Metric Connector System

Mechanical Specifications and Performance



Ground Return Shields for Right Angle Female Connectors

Base material		Copper alloy
Contact plating per IEC 512 Test 9A	Contact fingers	Gold plated
Performance level 2 per IEC 61076-4-101		≥ 250 mating cycles
Hole requirements for daughter card		0.6 ±0.05 mm after plating

Ground Return Shields for Vertical Female Connectors

Base material		Copper alloy
Contact plating per IEC 512 Test 9A	Contact fingers	Gold plated
Terminal plating per IEC 512 Test 9A	Extended terminals	Gold plated
Performance level 2 per IEC 61076-4-101		≥ 250 mating cycles
Hole requirements for daughter card		0.6 ±0.05 mm after plating

Shrouds

Temperature range		-55°C to +125°C
Housing material		PBT 30% glass filled
Flammability		UL 94 V-O

Coding Keys

Temperature range		-55°C to +125°C
Housing material		Polycarbonate 30% glass filled
Flammability		UL 94 HB
Mechanical strength		≥ 300 Newtons (N)
Weight		0.3 Grams (G) average

Latch Arm

Temperature range		-65°C to +125°C
Housing material		LCP 2000 30% glass filled
Flammability		UL 94 V-O

Cable Connectors

Female contact housing	Material	30% glass filled LCP
	Flammability	UL94V0
Over molding	Material	30% glass filled LCP
	Flammability	UL94V0
Locking combs	Material	30% glass filled LCP
Total weight of plastic material		1.0 grams
Shield	Material	phosphor bronze
	Plating	Gold plated
Contact	Material	phosphor bronze
	Plating	Gold plated

2.0 mm ERmet Hard Metric Connector System

7-Row Electrical Performance



The ERmet line of 2mm H.M. connectors set a new, higher standard for 2.0 mm electrical performance. A collection of test reports is available which completely characterizes the connectors' mechanical and high frequency performance. In addition, ERNI can provide a SPICE (Simulator Program for Integrated Circuit Emulation) model to customers, utilizing advanced circuit simulation methods.

In the Time Domain Reflectometry (TDR) plot shown below, note the connector exhibits an almost ideal, 50 ohm characteristic impedance. This smooth, discontinuity-free, impedance progression is due, in part, to both the uniform contact spacing and constant cross section, as well as the uniform dielectric constant. This is a result of the encapsulated terminals of the right angle female connector.

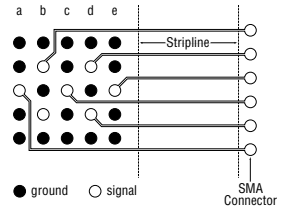
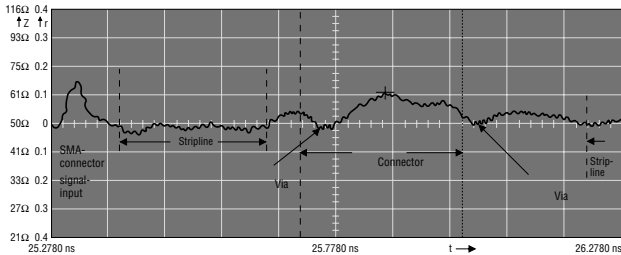

TDR plot showing the impedance progression from a 2mm H.M. connector. Signal ground pattern as shown.

High Frequency Characteristics

The chart below summarizes the electrical characteristics of a test board with similar pin assignments. Note the remarkably low propagation delay (132 ps) and low total skew (a-e = 46 ps).

These factors, combined with the low capacitance and low inductance of the connector, make the ERmet 2mm H.M. Connector the best choice for demanding, high speed applications.

parameter	connector pin row				
	a	b	c	d	e
capacitance C (f = 100 MHz)	2.5 pF	2.8 pF	2.9 pF	3.1 pF	3.2 pF
inductance L (f = 100 MHz)	6.8 nH	7.6 nH	8.3 nH	8.7 nH	10.5 nH
characteristic impedance	52 Ω	52 Ω	53 Ω	53 Ω	57 Ω
propagation delay*	111 ps (86) ps	119 ps (94) ps	126 ps (101) ps	141 ps (116) ps	157 ps (132) ps
signal skew	8 ps, 9 ps, 14 ps, 15 ps maximum 46 ps				
crosstalk (f = 100 MHz)	← 57 dB → ← 53 dB →				
Reflection factor (50 Ω and f = 100 MHz)	0.02	0.02	0.03	0.03	0.065
VSWR (f = 100 MHz)	1.04	1.04	1.06	1.06	1.14
Reflection loss [dB] (f = 100 MHz)	34	34	30.5	30.5	24

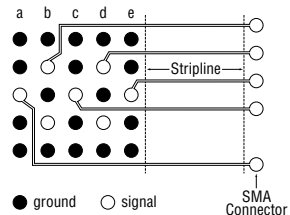

The measurement values are based on this pin configuration.

* The higher value of the propagation delay is measured from solder-side to solder-side (rear side). The value in parenthesis is calculated from component-side to component-side (front side).

2.0 mm ERmet Hard Metric Connector System

7-Row Electrical Performance



The specifications for contact current rating, dielectric withstanding voltages and creepage and clearance distances are all dependent on the contact loading configuration. For example, if contacts are loaded in a “chessboard pattern,” each contact can carry more current than if every contact is loaded.

Current Rating For Various Contact Mounting Configurations

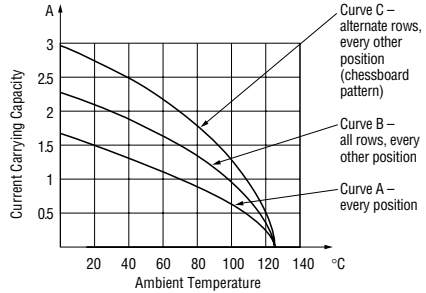

Dielectric Withstanding Voltage				
Contact/Contact:				
Row Designation		Fully Loaded	Every Other Position	Chessboard Pattern
Row a + c + e	Within the row	750V _{eff}	1500V _{eff}	–
Row b + d	Between the rows	1500V _{eff}	1500V _{eff}	–
Row a + b + c	Within the row	750V _{eff}	1500V _{eff}	1500V _{eff}
Row a + b + c + d	Between the rows	750V _{eff}	750V _{eff}	1200V _{eff}
Row a + b + c + d + e				
Contact to grounding rows or shielding frame: 750V _{eff}				

Creepage Distances And Clearances Dependent On Contact Layout							
Contact/Contact:							
Row Designation		Fully Loaded		Every Other Position		Chessboard Pattern	
		Backplane Male Connector	Daughter Card Female Connector	Backplane Male Connector	Daughter Card Female Connector	Backplane Male Connector	Daughter Card Female Connector
Row a + c + e	Within the row	0.8	0.6	2.5	2.5	–	–
Row b + d	Between the rows	2.5	2.5	2.5	2.5	–	–
Row a + b + c	Within the row	0.8	0.6	2.5	2.5	2.5	2.5
Row a + b + c + d							
Row a + b + c + d + e	Between the rows	0.8	0.6	0.8	0.6	1.5	1.2
Creepage and clearance distances for contacts in the outer contact rows (A and E) to shielding rows (optional) is 0.8 mm.							

2.0 mm ERmet Hard Metric Connector System

10-Row Electrical Performance



The ERmet line of 2mm H.M. connectors set a new, higher standard for 2.0 mm electrical performance. A collection of test reports is available which completely characterizes the connectors' mechanical and high frequency performance. In addition, ERNI can provide a SPICE (Simulator Program for Integrated Circuit Emulation) model to customers, utilizing advanced circuit simulation methods.

In the Time Domain Reflectometry (TDR) plot shown below, note the connector exhibits an almost ideal, 50 ohm characteristic impedance. This smooth, discontinuity-free, impedance progression is due, in part, to both the uniform contact spacing and constant cross section, as well as the uniform dielectric constant. This is a result of the encapsulated terminals of the right angle female connector.

High Frequency Characteristics

The chart below summarizes the electrical characteristics of a test board with similar pin assignments. These factors, combined with the low capacitance and

low inductance of the connector, make the ERmet 2mm H.M. Connector the best choice for demanding, high speed applications.

parameter	connection pin row							
	a	b	c	d	e	f	g	h
capacitance C [pF] f = 300 MHz	1.9	2.3	2.5	2.7	2.8	2.8	3.7	4.0
inductance L [nH] f = 100 MHz	5.4	6.3	6.9	7.5	8.1	8.9	11.9	15.5
characteristic impedance $z = \sqrt{L/C}$	53	52	53	53	54	56	57	62
propagation delay [ps]	110	120	130	140	150	160	175	190
signal skew [ps]	10		10		10		15	
	10		10		15		15	
crosstalk [dB] f=300 MHz	34.9		32.7		30.2		-28.61	
Reflection factor 50 Ohm f = 300 MHz	0.03	0.02	0.02	0.03	0.04	0.06	0.06	0.11
VSWR f = 300 MHz	1.06	1.04	1.04	1.06	1.08	1.13	1.13	1.25
Reflection loss [dB] f = 300 MHz	30.5	34.0	34.0	30.5	28.0	24.4	24.4	19.2

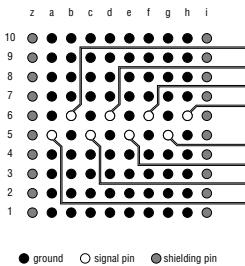

The measurement values are based on this pin configuration.

2.0 mm ERmet Hard Metric Connector System

10-Row Electrical Performance



The specifications for contact current rating, dielectric withstanding voltages and creepage and clearance distances are all dependent on the contact loading configuration. For example, if contacts are loaded in a “chessboard pattern,” each contact can carry more current than if every contact is loaded.

Current Rating For Various Contact Mounting Configurations

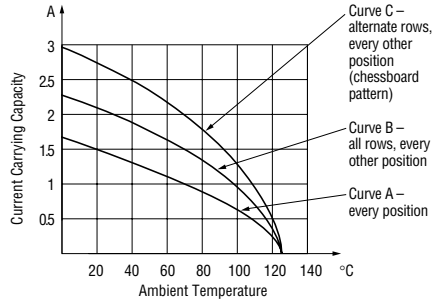

Dielectric Withstanding Voltage			
Row Designation	Contact/Contact:	Fully Loaded	Every Other Position
Row a+c+e+g	Within the row	750V _{eff}	1500V _{eff}
Row b+d+f+h	Between the rows	1500V _{eff}	1500V _{eff}
Row a+b+c	Within the row	750V _{eff}	1500V _{eff}
Row a+b+c+d			
Row a+b+c+d+e			
Row a+b+c+d+e+f			
Row a+b+c+d+e+f+g			
Row a+b+c+d+e+f+g+h	Between the rows	750V _{eff}	750V _{eff}
Contact to grounding rows or shielding frame: 750V _{eff}			

Creepage Distances And Clearances Dependent On Contact Layout							
Row Designation		Contact/Contact:					
		Fully Loaded		Every Other Position		Chessboard Pattern	
		Backplane Male Connector	Daughter Card Female Connector	Backplane Male Connector	Daughter Card Female Connector	Backplane Male Connector	Daughter Card Female Connector
Row a+c+e+g	Within the row	0.8	0.6	2.5	2.5	–	–
Row b+d+f+h	Between the rows	2.5	2.5	2.5	2.5	–	–
Row a+b+c	Within the row	0.8	0.6	2.5	2.5	2.5	2.5
Row a+b+c+d							
Row a+b+c+d+e							
Row a+b+c+d+e+f							
Row a+b+c+d+e+f+g							
Row a+b+c+d+e+f+g+h	Between the rows	0.8	0.6	0.8	0.6	1.5	1.2
Creepage and clearance distances for contacts in the outer contact rows (A and E) to shielding rows (optional) is 0.8 mm.							



Approval Certificates, Performance Levels And Ordering Information

Approval Certificates

UL Approved by the American approvals authority (Underwriters Laboratories Inc.) File number E 84703.

ISO 9001 All ERmet connectors are designed and produced in fully approved ERNI ISO 9001 facilities.

Bellcore GR 1217 CORE ERmet connectors are available that meet the requirements of Bellcore GR-1217-CORE for large systems in uncontrolled environments.

ECTF ERmet connectors are also available to meet the requirements of the Enterprise Computer Telephony Forum's (ECTF) H.110 specification.

IEC 917 And IEC 61076-4-101 The ERmet Connector System meets the requirements of IEC 61076-4-101 which was developed in accordance with the requirements of IEC 917 the standard for for Hard Metric mounting systems.

IEEE 1301 And IEEE 1101 And IEEE 1101.10 ERmet connectors were developed to meet the demanding board to backplane physical architecture of IEEE 1301 and have been adapted to meet the requirements of IEEE 1101 and IEEE 1101.10.

PICMG ERmet connectors have been adapted to meet the requirements of the CompactPCI specification as defined by the PICMG. Special length connectors with the required loading have been molded and assembled for these applications. Type AB connectors have been developed for rear transition card applications.

Performance Levels

207 Conforms to the requirements of IEC 61076-4-101 performance level 2 (\geq 250 mating cycles) in the contact area.
For detailed information, see Mechanical Specifications and Performance.

201 Conforms to the requirements of IEC 61076-4-101 performance level 2 (\geq 250 mating cycles) in both contact and terminal areas.

For additional performance levels, consult ERNI Customer Service.

Ordering Information

All ERNI ERmet 2mm H.M. Connectors for CompactPCI and VME64 Extensions are assigned a six digit part number. The following pages contain part numbers, along with product descriptions of many popular ERNI 2mm H.M. Connectors, complementary components, application, repair and installation tooling. In addition to the configurations listed in this catalog, others are available. Please consult ERNI customer service for more information.

2.0 mm ERmet Hard Metric Connector System

Right Angle Female Connectors Type A for Daughter Cards



2.0 mm ERmet

110 signal contacts
50 mm with multifunction block (for positioning and coding)

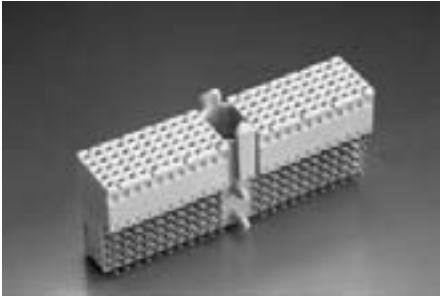

The ERmet type A female connector provides 110 contacts in a 5 row x 25 position (3 positions used by multifunction cavity), fully loaded configuration. This connector is used in the J1 and J4 positions of the CompactPCI® daughter card. The connector is designed for gas tight, pressfit installation and is provided in two different configurations: with integrated upper ground return shields and without integrated upper ground return shields. Lower ground return shields are available separately.

The ERmet type A female connector has a multifunction cavity that incorporates pre-alignment guides and accepts optional coding keys. This connector is designed to be used alone or in conjunction with either a type B, C, L, M or N ERmet connector. The type A female is also available with a locating and strain relief peg that helps secure the connector to the printed circuit board (PCB).

Dimensional drawings and board hole pattern

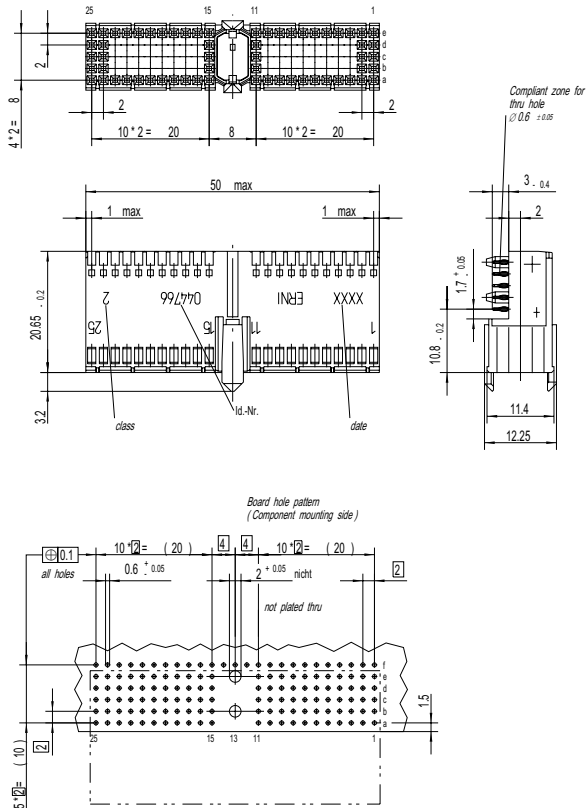

Note: The numbering on the connectors themselves is in accordance with the EC 61076-4-101 standard. All dimensions in mm.

2.0 mm ERmet Hard Metric Connector System

Right Angle Female Connectors Type A for Daughter Cards



Ordering Information

Configuration	Used For	No. of Pins	Part Number
Type A Without Shield, Without Peg 	CompactPCI™ J1, J4	110	044146
Type A Without Shield, With Peg 		110	044766
Type A With Shield, Without Peg 	CompactPCI™ J1, J4	110	064176
Type A With Split Shield, Partially Loaded 	 J4 Telecom	90	104512
Type A With Split Shield, Partially Loaded 	 rJ4 Telecom	90	104697
Lower Shield For Type A And AB 	CompactPCI™ J1, J4		

2.0 mm ERmet Hard Metric Connector System

Vertical Male Connectors Type A for Backplanes



2.0 mm ERmet

110 signal contacts
50 mm with multifunction block (for positioning and coding)

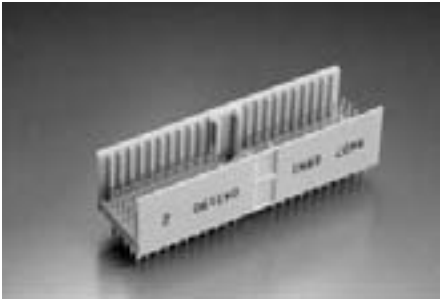

The ERmet type A vertical male connector provides 110 signal contacts and 44 ground shield contacts in 5+2 row x 25 position (3 positions used by multifunction cavity), fully loaded configuration. This connector is used in the P1 and P4 positions of a CompactPCI® backplane. With 15 different standard pin lengths to choose from, this is one of the most versatile connectors available. The connector is designed for gas tight pressfit installation.

The ERmet type A male connector has a multifunction cavity that incorporates pre-alignment guides and accepts optional coding keys. This connector is designed to be used alone or in conjunction with either type B, C, L, M or N ERmet connectors.

Dimensional drawings and board hole pattern

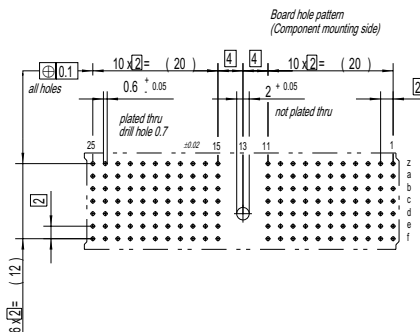
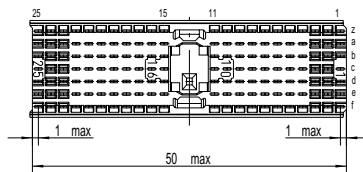
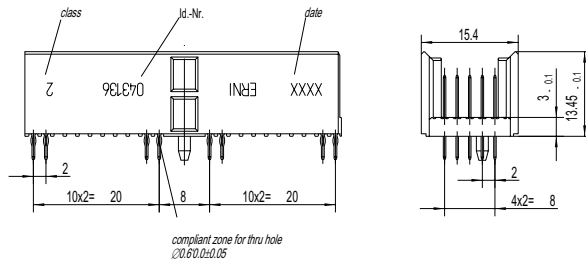

Note: The numbering on the connectors themselves is in accordance with the EC 61076-4-101 standard. All dimensions in mm.

2.0 mm ERmet Hard Metric Connector System

Vertical Male Connectors Type A for Backplanes



Ordering Information

Configuration	Used For	No. of Pins	Part Number
Type A With Peg 		110	043136
Type A With Peg 		110	043190
Type A With Peg And Extended Terminals For Shrouding 		110	043477
Type A Without Peg 		110	044148
Type A With Peg 		110	044149

Contact versions

ERNI can accommodate any pattern of male connector contact loading.

For shield rows z and f (7 row connectors) or z and y (10 row connectors), level 3 contacts should be specified. For rear I/O and shrouds, choose contacts with the R1, R2 or R3 terminal length. Each contact has a unique letter designation. Use this letter designation when filling in the contact loading requirements on the ERNI Customer Request Form.

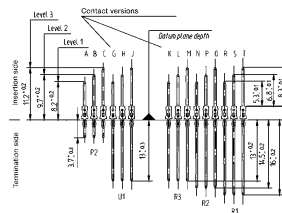

2.0 mm ERmet Hard Metric Connector System

Vertical Male Connectors Type A for Backplanes



2.0 mm ERmet

Ordering Information

Configuration	Used For	No. of Pins	Part Number
<p>Type A With Peg</p>		154	053007
<p>Type A With Peg And Extended Terminals For Shrouding</p>		154	054034
<p>Type A With Peg And Extended Terminals For Shrouding</p>		154	054185
<p>Type A With Peg</p>		154	054528
<p>Type A With Peg</p>	<p>CompactPCI™</p> <p>P1 Per PICMG 2.0 R2.1</p>	154	064097

Contact versions

ERNI can accommodate any pattern of male connector contact loading.

For shield rows z and f (7 row connectors) or z and y (10 row connectors), level 3 contacts should be specified. For rear I/O and shrouds, choose contacts with the R1, R2 or R3 terminal length. Each contact has a unique letter designation. Use this letter designation when filling in the contact loading requirements on the ERNI Customer Request Form.

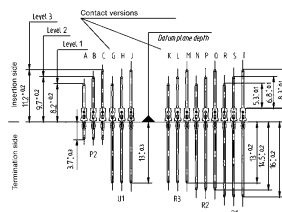

2.0 mm ERmet Hard Metric Connector System

Vertical Male Connectors Type A for Backplanes



Ordering Information

Configuration	Used For	No. of Pins	Part Number	
Type A With Peg And Extended Terminals For Shrouding 	CompactPCI™	P4	154	064688
Type A With Peg And Extended Terminals For Shrouding 	CompactPCI™	P4	154	103968
Type A With Peg And Extended Terminals For Shrouding 	CompactPCI™	P4	154	103975
Type A Without Peg 	ECTF™ ERmet Connector Technology	P4 Telecom	100	923160
Type A With Peg 	CompactPCI™	P1	154	923190

Contact versions

ERNI can accommodate any pattern of male connector contact loading.

For shield rows z and f (7 row connectors) or z and y (10 row connectors), level 3 contacts should be specified. For rear I/O and shrouds, choose contacts with the R1, R2 or R3 terminal length. Each contact has a unique letter designation. Use this letter designation when filling in the contact loading requirements on the ERNI Customer Request Form.

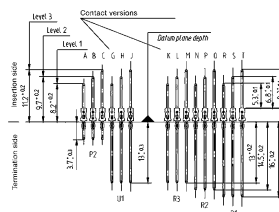

2.0 mm ERmet Hard Metric Connector System

Vertical Male Connectors Type A for Backplanes



2.0 mm ERmet

Ordering Information

Configuration	Used For	No. of Pins	Part Number
<p>Type A With Peg And Extended Terminals For Shrouding</p>	CompactPCI™		
	P1 Special	154	923197
<p>Type A Without Peg And With Extended Terminals</p>	ECTF™		
	P4 Telecom	100	923212
<p>Type A Without Peg And With Extended Terminals</p>	CompactPCI™		
	P1	154	923342
<p>Type A With Extended Terminals For Shrouding</p>	CompactPCI™		
	P4	132	923347

Contact versions

ERNI can accommodate any pattern of male connector contact loading.

For shield rows z and f (7 row connectors) or z and y (10 row connectors), level 3 contacts should be specified. For rear I/O and shrouds, choose contacts with the R1, R2 or R3 terminal length. Each contact has a unique letter designation. Use this letter designation when filling in the contact loading requirements on the ERNI Customer Request Form.

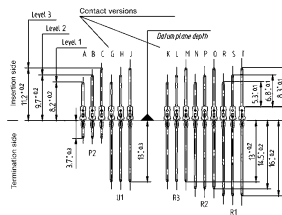

2.0 mm ERmet Hard Metric Connector System

Vertical Female Connectors Type A



110 signal contacts
50 mm with multifunction block (for positioning and coding)

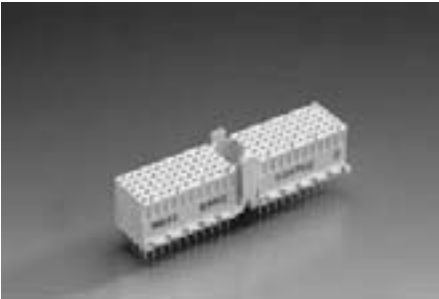

The ERmet type A vertical female connector provides 110 contacts in a 5 row x 22 position fully loaded configuration. Versions with optional “z” and “f” row shields are available as well as extended terminals for use in stacking applications with rear shrouds.

Two spacer heights are also available: 3.1 mm and 9.6 mm to provide additional component clearance.

The ERmet type A female connector has a multifunctional cavity that incorporates pre-alignment pins and optional coding keys. The pressfit terminals provide a convenient and reliable gas tight connection.

This connector may be used alone or in conjunction with Type B and C vertical female connectors.

Dimensional drawings and board hole pattern

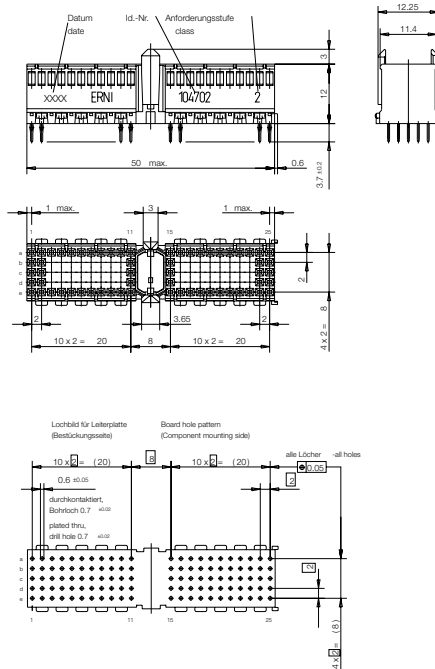

Note: The numbering on the connectors themselves is in accordance with the EC 61076-4-101 standard. All dimensions in mm.

2.0 mm ERmet Hard Metric Connector System

Vertical Female Connectors Type A



* Termination + Board To Board Distance

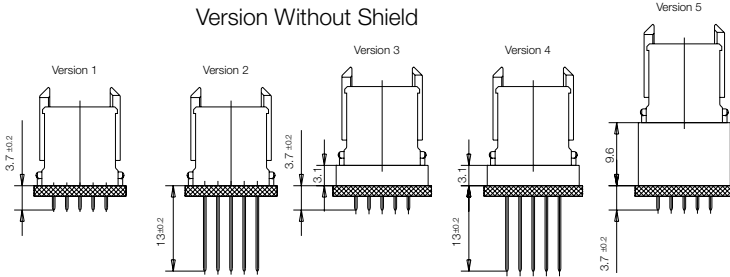

Version	Board To Board Distance *
1	15-16.5
2	15-16.5
3	18.4-20
4	18.4-20
5	25-26.5

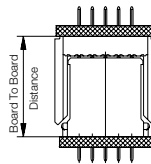

* based on contact level 1
 other board to board distances for remaining levels on request
 (Please contact our Customer Service)

Version With Shield

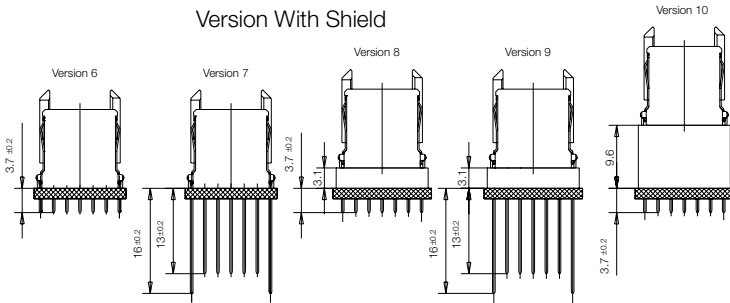

Version	Board To Board Distance *
6	15-16.5
7	15-16.5
8	18.4-20
9	18.4-20
10	25-26.5

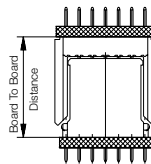

* based on contact level 1
 other board to board distances for remaining levels on request
 (Please contact our Customer Service)





Note: All dimensions in mm.

2.0 mm ERmet Hard Metric Connector System

Vertical Female Connectors Type A

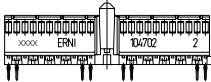

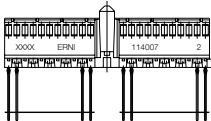
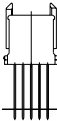
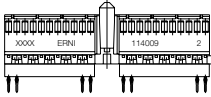
Ordering Information

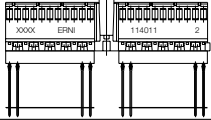
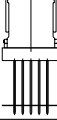
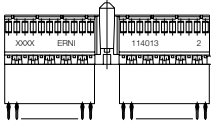
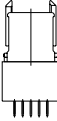
Configuration	Used For	No. of Pins	Part Number	
Type A Without Shield, Without Peg Version 1 *			110	104702
Type A Without Shield, Without Peg Version 2 *			110	114007
Type A Without Shield, Without Peg Version 3 *			110	114009
Type A Without Shield, Without Peg Version 4 *			110	114011
Type A Without Shield, Without Peg Version 5 *			110	114013







2.0 mm ERmet Hard Metric Connector System

Vertical Female Connectors Type A

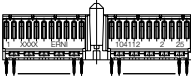

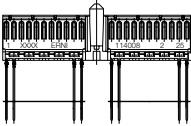
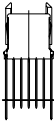
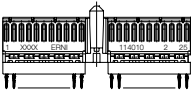
2.0 mm ERmet

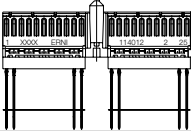
Ordering Information

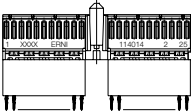
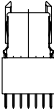
Configuration	Used For	No. of Pins	Part Number	
Type A With Shield, Without Peg Version 6 *			110	104112
Type A With Shield, Without Peg Version 7 *			110	114008
Type A With Shield, Without Peg Version 8 *			110	114010
Type A With Shield, Without Peg Version 9 *			110	114012
Type A With Shield, Without Peg Version 10 *			110	114014

2.0 mm ERmet Hard Metric Connector System

Right Angle Female Connectors Type B for Daughter Cards



125 signal contacts
50 mm without multifunction block

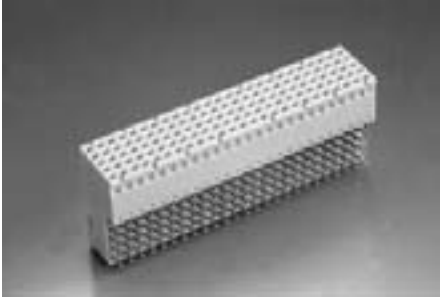

The ERmet type B female connector provides 125 contacts in a 5 row x 25 position fully loaded configuration.

The connector is designed for gas tight, pressfit installation and is provided in two different configurations: with integrated ground return shields and without integrated upper ground return shields. Lower ground return shields are available separately.

The ERmet type B female connector has an uninterrupted pin field with no multifunction cavity. This connector is not designed to be used alone, but is intended to be used in conjunction with either a type A, C, L, M or N ERmet connector.

Dimensional drawings and board hole pattern

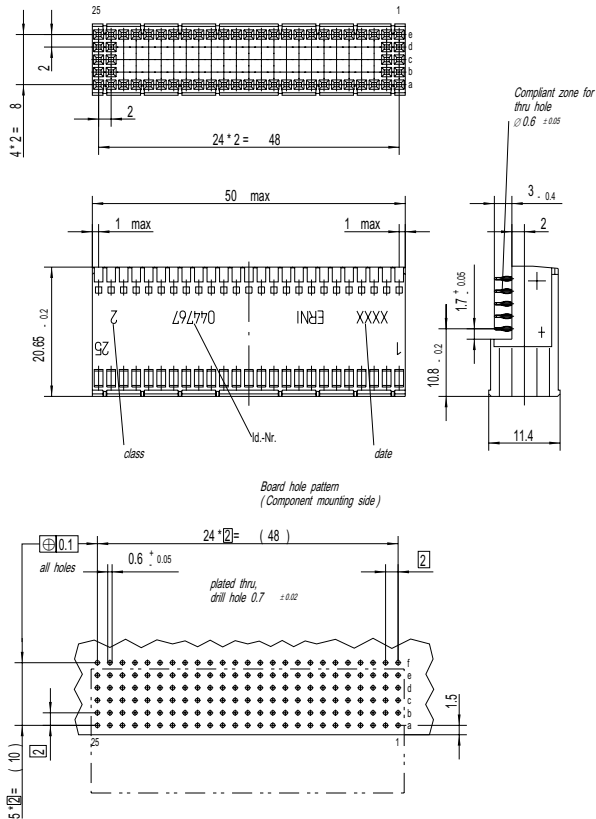

2.0 mm ERmet Hard Metric Connector System

Right Angle Female Connectors Type B for Daughter Cards



2.0 mm ERmet

Ordering Information







Configuration	Used For	No. of Pins	Part Number
Type B Without Shield, Without Peg 		125	044767
Type B With Upper Shield, Without Peg 		125	064179
Type B Without Shield, Without Peg 	CompactPCI™ J2, J5	110	914797
Type B With Upper Shield 	CompactPCI™ J2, J5	110	064785
Type B Without Shield, Without Peg 	CompactPCI™ J3	95	914794
Type B With Upper Shield 	CompactPCI™ J3	95	064784

2.0 mm ERmet Hard Metric Connector System

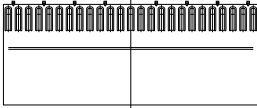
Right Angle Female Connectors Type B for Daughter Cards

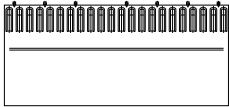

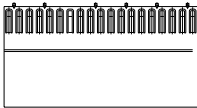
Ordering Information

Configuration	Used For	No. of Pins	Part Number
Lower Shield For Type B  			044452
Lower Shield For Type B  	CompactPCI™	J2, J5	064783
Lower Shield For Type B  	CompactPCI™	J3	064782

2.0 mm ERmet Hard Metric Connector System

Vertical Male Connectors Type B for Backplanes



2.0 mm ERmet

125 signal contacts
50 mm without multifunction block

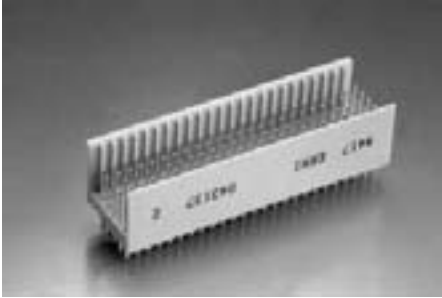

The ERmet CompactPCI type B vertical male connector provides 125 signal contacts and 50 ground shield contacts in a 5+2 row x 25, fully loaded configuration. With 15 different standard pin lengths to choose from, this is one of the most versatile connectors available. The connector is designed for gas tight pressfit installation. The ERmet type B vertical male connector has an uninterrupted pin field with no multifunction cavity. This connector is not designed to be used alone, but it is intended to be used in conjunction with either a type A, C, L, M or N ERmet connector.

Dimensional drawings and board hole pattern

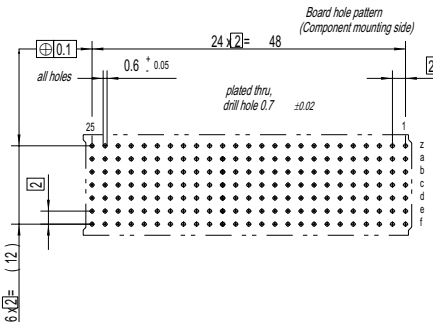
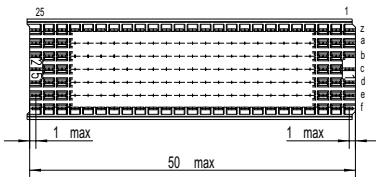
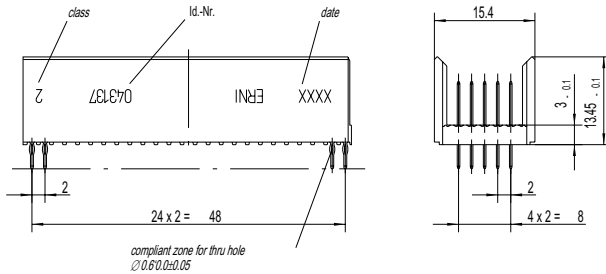

Note: The numbering on the connectors themselves is in accordance with the EC 61076-4-101 standard. All dimensions in mm.

2.0 mm ERmet Hard Metric Connector System

Vertical Male Connectors Type B for Backplanes



Ordering Information

Configuration	Used For	No. of Pins	Part Number
<p>Type B</p>		125	043137
<p>Type B</p>		125	053088
<p>Type B</p>		175	053008
<p>Type B</p>		175	054293
<p>Type B</p>		175	054392

Contact versions

ERNI can accommodate any pattern of male connector contact loading.

For shield rows z and f (7 row connectors) or z and y (10 row connectors), level 3 contacts should be specified. For rear I/O and shrouds, choose contacts with the R1, R2 or R3 terminal length. Each contact has a unique letter designation. Use this letter designation when filling in the contact loading requirements on the ERNI Customer Request Form.

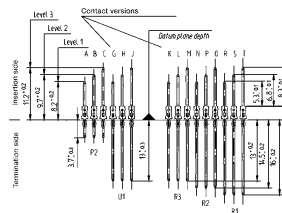

2.0 mm ERmet Hard Metric Connector System

Vertical Male Connectors Type B for Backplanes



2.0 mm ERmet

Ordering Information

Configuration	Used For	No. of Pins	Part Number	
Type B With Extended Terminals 		125	043476	
Type B With Extended Terminals 		175	054186	
Type B With Extended Terminals 		175	064522	
Type B 	CompactPCI™ 	P2, P5	154	914796
Type B 	ECTF 	P5 Telecom	154	923162

Contact versions

ERNI can accommodate any pattern of male connector contact loading.

For shield rows z and f (7 row connectors) or z and y (10 row connectors), level 3 contacts should be specified. For rear I/O and shrouds, choose contacts with the R1, R2 or R3 terminal length. Each contact has a unique letter designation. Use this letter designation when filling in the contact loading requirements on the ERNI Customer Request Form.

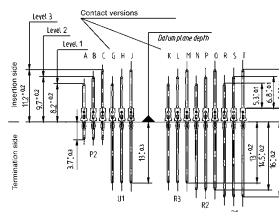

2.0 mm ERmet Hard Metric Connector System

Vertical Male Connectors Type B for Backplanes



Ordering Information

Configuration	Used For	No. of Pins	Part Number
Type B With Extended Terminals 	CompactPCI™ P2, P5	154	064690
Type B With Extended Terminals For Shrouding 	CompactPCI™ P2	154	923131
Type B (AB Compatible) With Extended Terminals For Shrouding 	 P5 Telecom	132	923339
Type B (AB Compatible) With Extended Terminals For Shrouding 	CompactPCI™ P2	154	923340
Type B (AB Compatible) With Extended Terminals For Shrouding 	CompactPCI™ P2	132	923345

Contact versions

ERNI can accommodate any pattern of male connector contact loading.

For shield rows z and f (7 row connectors) or z and y (10 row connectors), level 3 contacts should be specified. For rear I/O and shrouds, choose contacts with the R1, R2 or R3 terminal length. Each contact has a unique letter designation. Use this letter designation when filling in the contact loading requirements on the ERNI Customer Request Form.

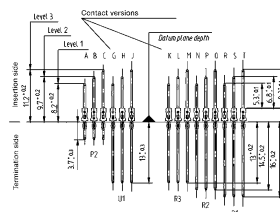



2.0 mm ERmet Hard Metric Connector System

Vertical Male Connectors Type B for Backplanes

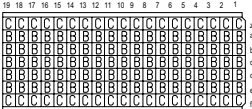

2.0 mm ERmet

Ordering Information

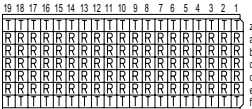
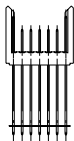
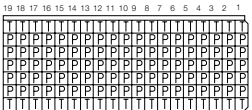
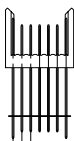
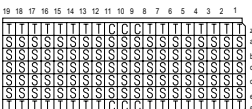
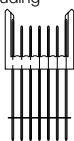
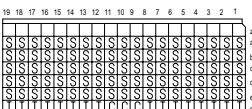
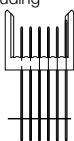
Configuration	Used For	No. of Pins	Part Number
Type B  	CompactPCI™ P3	133	103670
Type B With Extended Terminals  	CompactPCI™ P3	133	914793
Type B With Extended Terminals For Shrouding  	CompactPCI™ P3	133	923132
Type B (AB Compatible) With Extended Terminals For Shrouding  	CompactPCI™ P3	133	923341
Type B (AB Compatible) With Extended Terminals For Shrouding  	CompactPCI™ P3	114	923346

Contact versions

ERNI can accommodate any pattern of male connector contact loading.

For shield rows z and f (7 row connectors) or z and y (10 row connectors), level 3 contacts should be specified. For rear I/O and shrouds, choose contacts with the R1, R2 or R3 terminal length. Each contact has a unique letter designation. Use this letter designation when filling in the contact loading requirements on the ERNI Customer Request Form.

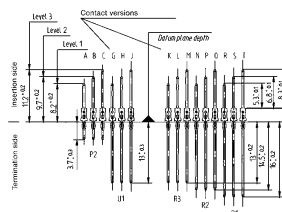



2.0 mm ERmet Hard Metric Connector System

Vertical Male Connectors Type B for Backplanes

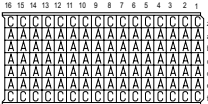

Ordering Information

Configuration	Used For	No. of Pins	Part Number
Type B 		112	064766

Contact versions

ERNI can accommodate any pattern of male connector contact loading.

For shield rows z and f (7 row connectors) or z and y (10 row connectors), level 3 contacts should be specified. For rear I/O and shrouds, choose contacts with the R1, R2 or R3 terminal length. Each contact has a unique letter designation. Use this letter designation when filling in the contact loading requirements on the ERNI Customer Request Form.

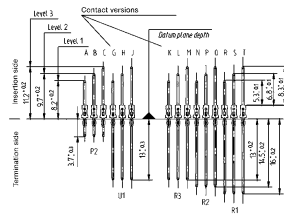

2.0 mm ERmet Hard Metric Connector System

Vertical Female Connectors Type B



2.0 mm ERmet

125 signal contacts
50 mm without multifunction block

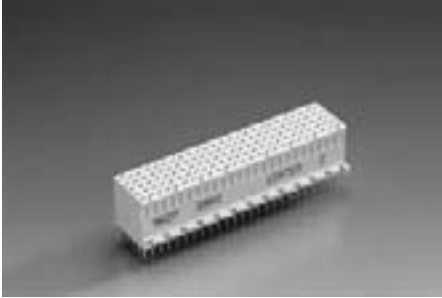

The ERmet type B vertical female connector provides 125 contacts in a 5 row x 25 position fully loaded configuration. Versions with optional "z" and "f" row shields are available as well as extended terminals for use in stacking applications with rear shrouds.

Two spacer heights are also available: 3.1 mm and 9.6 mm to provide additional component clearance.

The ERmet type B vertical female connector has an uninterrupted contact field and no multifunction cavity. This connector is not designed to be used alone, but is intended to be used with either a Type A or C female ERmet connector.

Dimensional drawings and board hole pattern

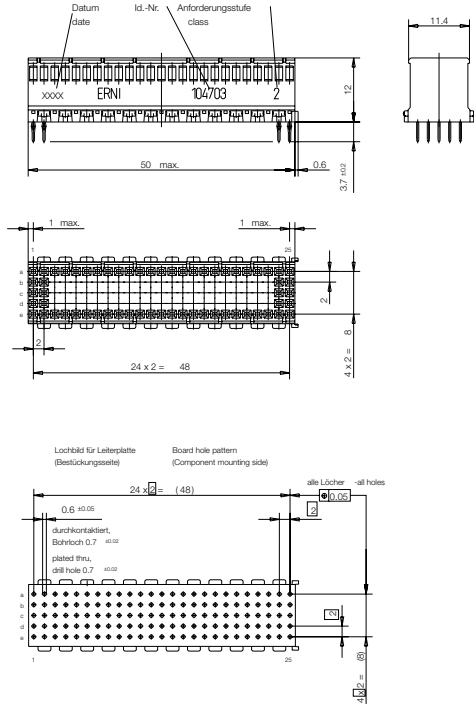

Note: The numbering on the connectors themselves is in accordance with the EC 61076-4-101 standard. All dimensions in mm.

2.0 mm ERmet Hard Metric Connector System

Vertical Female Connectors Type B



* Termination + Board To Board Distance

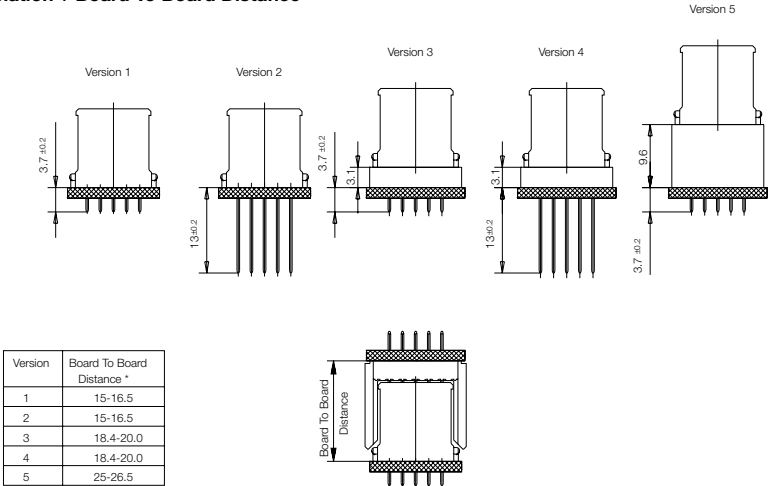

* based on contact level 1
 other board to board distances for remaining levels on request
 (Please contact our Customer Service)

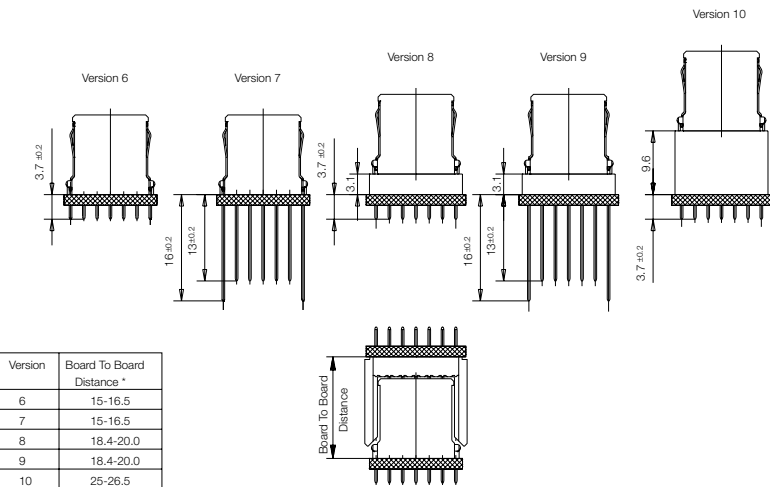

* based on contact level 1
 other board to board distances for remaining levels on request
 (Please contact our Customer Service)

Note: All dimensions in mm.

2.0 mm ERmet Hard Metric Connector System

Vertical Female Connectors Type B



2.0 mm ERmet

Ordering Information

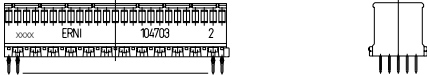
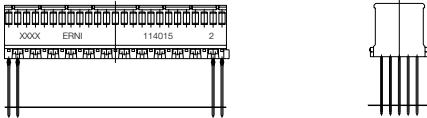
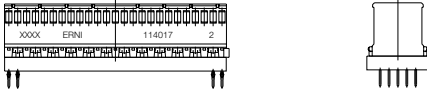
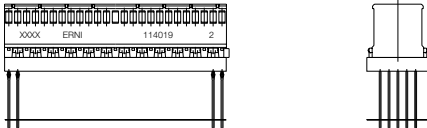
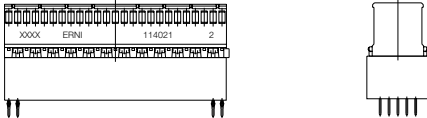







Configuration	Used For	No. of Pins	Part Number
Type B Without Shield, Without Peg Version 1 * 		125	104703
Type B Without Shield, Without Peg Version 2 * 		125	114015
Type B Without Shield, Without Peg Version 3 * 		125	114017
Type B Without Shield, Without Peg Version 4 * 		125	114019
Type B Without Shield, Without Peg Version 5 * 		125	114021

2.0 mm ERmet Hard Metric Connector System

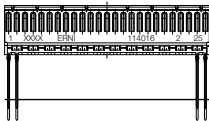
Vertical Female Connectors Type B

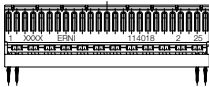

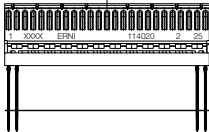
Ordering Information

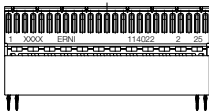
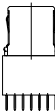
Configuration	Used For	No. of Pins	Part Number	
Type B With Shield, Without Peg Version 6 *			125	104113
Type B With Shield, Without Peg Version 7 *			125	114016
Type B With Shield, Without Peg Version 8 *			125	114018
Type B With Shield, Without Peg Version 9 *			125	114020
Type B With Shield, Without Peg Version 10 *			125	114022











2.0 mm ERmet Hard Metric Connector System

Vertical Female Connectors Type B

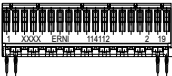

2.0 mm ERmet

Ordering Information

Configuration	Used For	No. of Pins	Part Number
Type B With Shield, Without Peg Version 6 *			
 		110	114114
Type B With F-row Shield, Without Peg Version 6 *	CompactPCI™		
 	P2 / P4	110	114134
Type B Without Shield, Without Peg Version 1 *			
 		95	114111
Type B With Shield, Without Peg Version 6 *			
 		95	114112
Type B With F-row Shield, Without Peg Version 6 *	CompactPCI™		
 	P2 / P4	95	114133

2.0 mm ERmet Hard Metric Connector System

Right Angle Female Connectors Type AB for Daughter Cards



125 signal contacts
50 mm without multifunction block

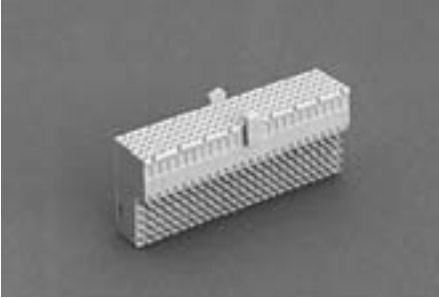

The ERmet type AB female connector provides 125 contacts in a 5 row x 25 fully loaded configuration, 110 contacts in a 5 row x 22 position fully loaded configuration or 95 pins in a 5 row x 19 position configuration. The 19 position connector is used in the rJ2 location and the 22 position connector is used in the rJ2 and rJ5 locations of the CompactPCI® rear transition card. The connector is designed for gas tight, pressfit installation and is provided in two different configurations: with integrated ground return shields and without integrated upper ground return shields. Lower ground return shields are available separately.

The ERmet type AB female connector has an uninterrupted pin field with no multifunction cavity but does have integral pre-alignment guides. This connector can be used alone or in conjunction with either a type A, B or C ERmet connector. This connector will provide the necessary alignment for rear transition applications.

Dimensional drawings and board hole pattern

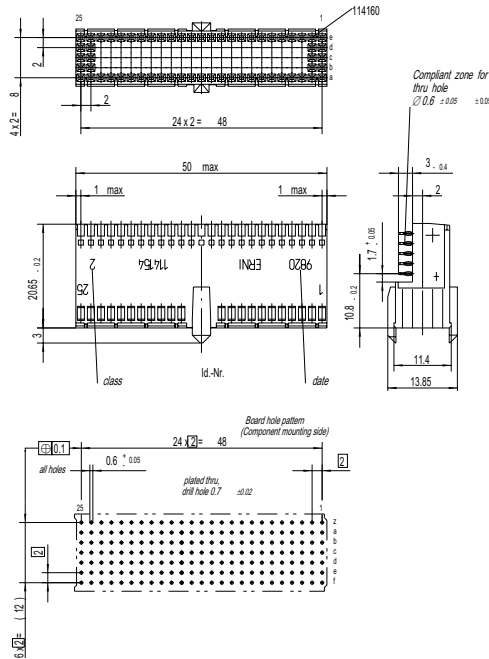

Note: The numbering on the connectors themselves is in accordance with the EC-61076-4-101 standard. All dimensions in mm.

2.0 mm ERmet Hard Metric Connector System

Right Angle Female Connectors Type AB for Daughter Cards



2.0 mm ERmet

Ordering Information







Configuration	Used For	No. of Pins	Part Number
Type AB Without Shield, Without Peg 		125	114154
Type AB With Shield, Without Peg 		125	114538
Type AB Without Shield, Without Peg 	CompactPCI™ rJ2, rJ5	110	104933
Type AB With Shield, Without Peg 	CompactPCI™ rJ2, rJ5	110	114809
Type AB Without Shield, Without Peg 	CompactPCI™ rJ3	95	114529
Type AB With Shield, Without Peg 	CompactPCI™ rJ3	95	114810

2.0 mm ERmet Hard Metric Connector System

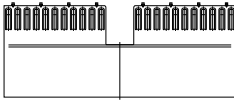
Right Angle Female Connectors Type AB for Daughter Cards

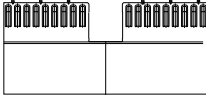

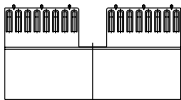
Ordering Information

Configuration	Used For	No. of Pins	Part Number
Lower Shield For Type A And AB 			044446
Lower Shield For Type A And Type AB 			114231
Lower Shield For Type A And Type AB 			923110

2.0 mm ERmet Hard Metric Connector System

Vertical Male Connectors Type AB for Backplanes



2.0 mm ERmet

125 signal contacts
50 mm without multifunction block

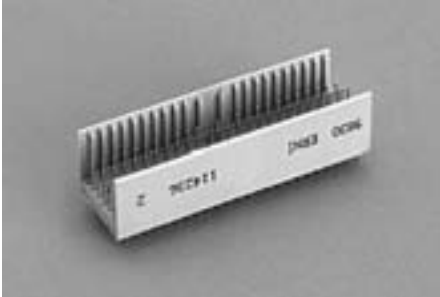

The ERmet type AB vertical male connector provides 125 signal contacts and 44 ground shield contacts in 5+2 row x 25 position, fully loaded configuration. This connector is used in the P1 and P4 positions of a CompactPCI® backplane. With 15 different standard pin lengths to choose from, this is one of the most versatile connectors available. The connector is designed for gas tight pressfit installation. The ERmet type AB male connector has an uninterrupted pin field with pre-alignment guides, but does not accept coding keys. This connector can be used alone, or it can be used with either type A, C, L, M or N ERmet connectors.

Dimensional drawings and board hole pattern

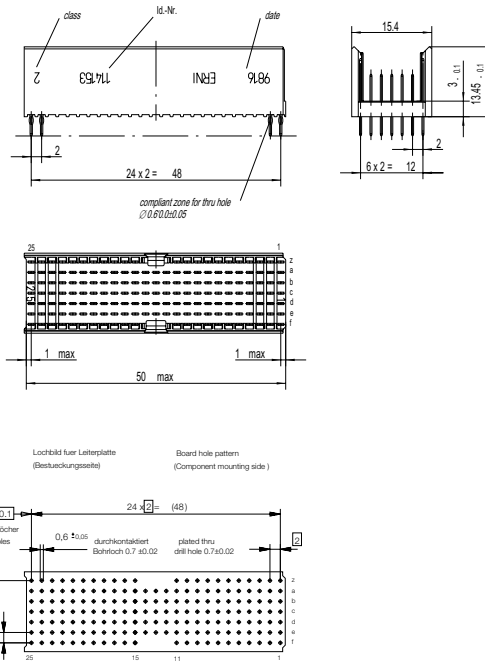

Note: The numbering on the connectors themselves is in accordance with the EC 61076-4-101 standard. All dimensions in mm.

2.0 mm ERmet Hard Metric Connector System

Vertical Male Connectors Type AB for Backplanes



Ordering Information

Configuration	Used For	No. of Pins	Part Number
Type AB Without Shield, Without Peg 		125	114236
Type AB With Shield, Without Peg 		169	114153
Type AB With Shield, Without Peg 		169	114539

Contact versions

ERNI can accommodate any pattern of male connector contact loading.
 For shield rows z and f (7 row connectors) or z and y (10 row connectors), level 3 contacts should be specified. For rear I/O and shrouds, choose contacts with the R1, R2 or R3 terminal length. Each contact has a unique letter designation. Use this letter designation when filling in the contact loading requirements on the ERNI Customer Request Form.

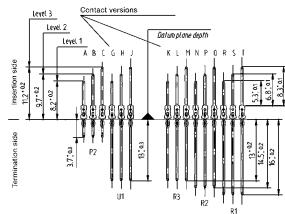

2.0 mm ERmet Hard Metric Connector System

Right Angle Female Connectors Type C for Daughter Cards



55 signal contacts
25 mm extension module

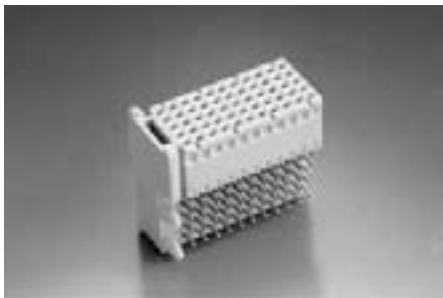

The ERmet type C female connector provides 55 contacts in a 5 row x 11 position fully loaded configuration. The connector is designed for gas tight, pressfit installation and is provided in two different configurations: with integrated upper ground return shields and without integrated upper ground return shields. Lower ground return shields are available separately.

The ERmet type C female connector has pre-alignment guides. This connector can be used alone or in conjunction with either a type A, B, L, M or N ERmet connector, however, it can only be installed at the lower end of a connector row.

The type C female is also available with a locating and strain relief peg that helps secure the connector to the printed circuit board (PCB).

Dimensional drawings and board hole pattern

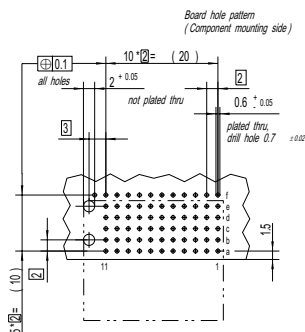
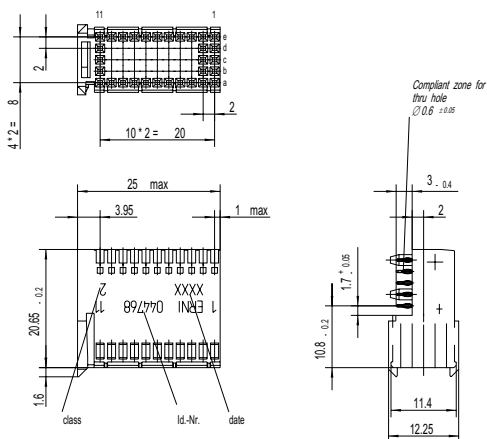

Note: The numbering on the connectors themselves is in accordance with the EC 61076-4-101 standard. All dimensions in mm.

2.0 mm ERmet Hard Metric Connector System

Right Angle Female Connectors Type C for Daughter Cards



Ordering Information

Configuration	Used For	No. of Pins	Part Number
Type C Without Shield, Without Peg 		55	044145
Type C With Shield, Without Peg 		55	064198
Type C Without Shield, With Peg 		55	044768
Type C With Shield, With Peg 		55	064556
Lower Shield For Type C 			044458

2.0 mm ERmet Hard Metric Connector System

Vertical Male Connectors Type C for Backplanes



2.0 mm ERmet

55 signal contacts
25 mm extension module

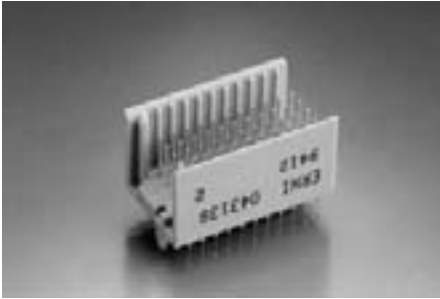

The ERmet type C vertical male connector provides 55 signal contacts and 22 ground shield contacts in 5+2 row x 11 position, fully loaded configuration. With 15 different standard pin lengths to choose from, this is one of the most versatile connectors available. The connector is designed for gas tight pressfit installation. The ERmet type C vertical male connector incorporates pre-alignment guides but has no multi function cavity. This connector is designed to be used alone or in conjunction with either type B, L, M or N ERmet connectors, however it can only be installed at the lower end of a connector row.

Dimensional drawings and board hole pattern

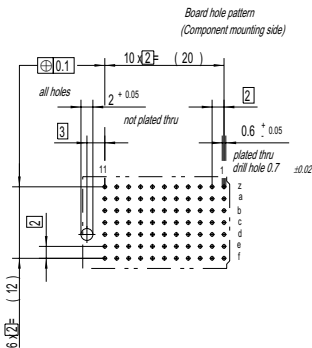
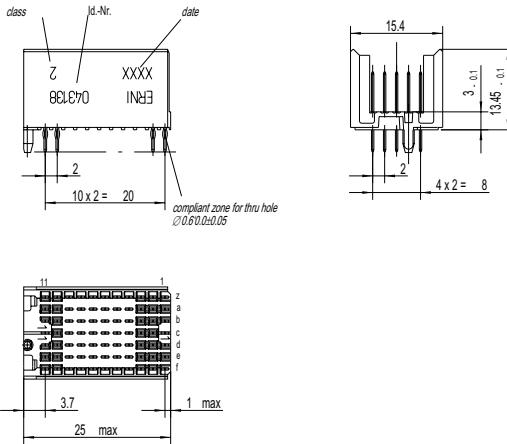







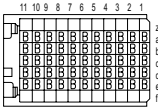

Note: The numbering on the connectors themselves is in accordance with the EC 61076-4-101 standard. All dimensions in mm.

2.0 mm ERmet Hard Metric Connector System

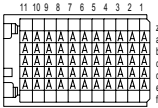
Vertical Male Connectors Type C for Backplanes

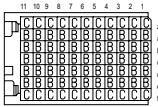

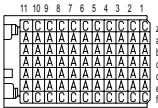
Ordering Information

Configuration	Used For	No. of Pins	Part Number
Type C Without Shield, With Peg  		55	043138
Type C Without Shield, With Peg  		55	044147
Type C With Shield, Without Peg  		77	054546
Type C With Shield, With Peg  		77	053009

Contact versions

ERNI can accommodate any pattern of male connector contact loading.

For shield rows z and f (7 row connectors) or z and y (10 row connectors), level 3 contacts should be specified. For rear I/O and shrouds, choose contacts with the R1, R2 or R3 terminal length. Each contact has a unique letter designation. Use this letter designation when filling in the contact loading requirements on the ERNI Customer Request Form.

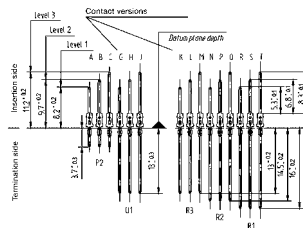



2.0 mm ERmet Hard Metric Connector System

Vertical Male Connectors Type C for Backplanes

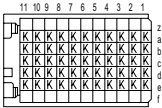
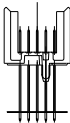
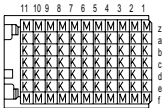
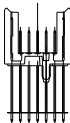

2.0 mm ERmet

Ordering Information

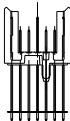
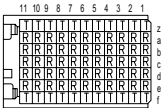
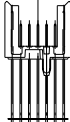
Configuration	Used For	No. of Pins	Part Number
Type C Without Shield, With Peg And With Extended Terminals  		55	054129
Type C With Shield, With Peg And With Extended Terminals  		77	064550
Type C With Shield, With Peg And With Extended Terminals  		77	064572
Type C With Shield, With Peg And With Extended Terminals  		77	103926

Contact versions

ERNI can accommodate any pattern of male connector contact loading.
 For shield rows z and f (7 row connectors) or z and y (10 row connectors), level 3 contacts should be specified. For rear I/O and shrouds, choose contacts with the R1, R2 or R3 terminal length. Each contact has a unique letter designation. Use this letter designation when filling in the contact loading requirements on the ERNI Customer Request Form.

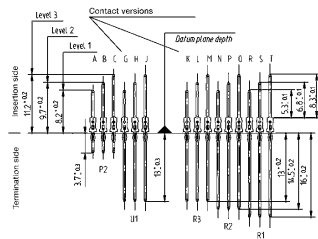

2.0 mm ERmet Hard Metric Connector System

Vertical Female Connectors Type C



55 signal contacts
25 mm extension module



The ERmet type C vertical female connector provides 55 contacts in a 5 row x 11 position fully loaded configuration. Versions with optional “z” and “f” row shields are available as well as extended terminals for use in stacking applications with rear shrouds.

Two spacer heights are also available: 3.1 mm and 9.6 mm to provide necessary component clearance.

The ERmet type C vertical female has no multifunctional cavity but is equipped with pre-alignment guides. The pressfit terminals provide a convenient and reliable gas tight connection.

This connector may be used alone or in conjunction with either a type A or B vertical female connector, however it can only be installed at the lower end of a connector row.

Dimensional drawings and board hole pattern

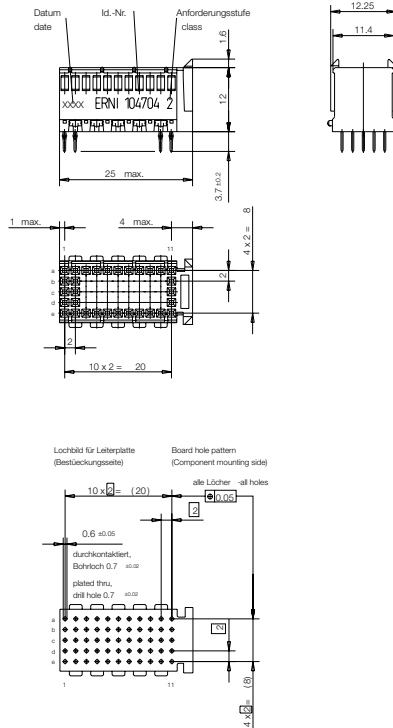

Note: The numbering on the connectors themselves is in accordance with the EC-61076-4-101 standard. All dimensions in mm.

2.0 mm ERmet Hard Metric Connector System

Vertical Female Connectors Type C



* Termination + Board To Board Distance

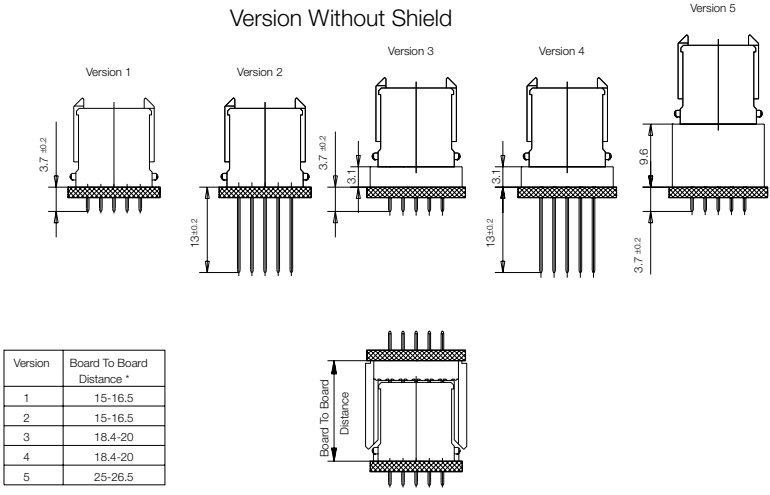

* based on contact level 1
 other board to board distances for remaining levels on request
 (Please contact our Customer Service)

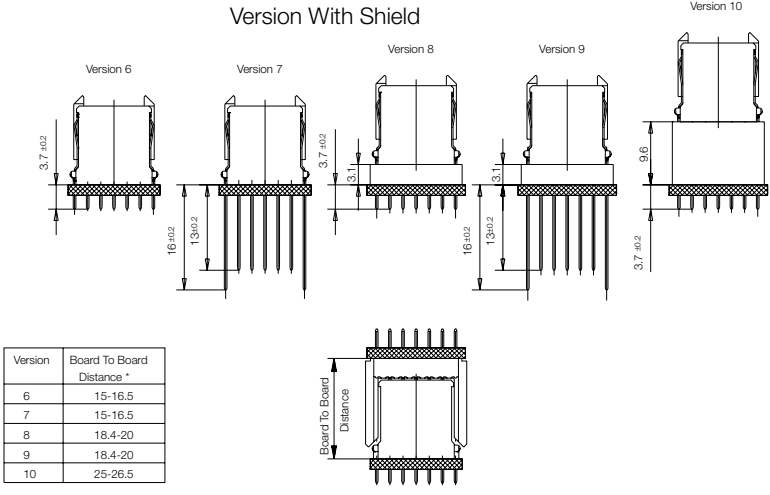

* based on contact level 1
 other board to board distances for remaining levels on request
 (Please contact our Customer Service)





Note: All dimensions in mm.

2.0 mm ERmet Hard Metric Connector System

Vertical Female Connectors Type C

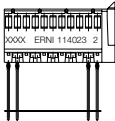
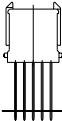
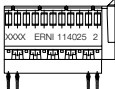

Ordering Information

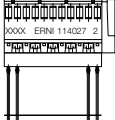
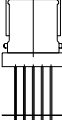
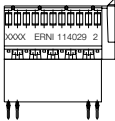
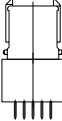
Configuration	Used For	No. of Pins	Part Number	
Type C Without Shield, Without Peg Version 1 *			55	104704
Type C Without Shield, Without Peg Version 2 *			55	114023
Type C Without Shield, Without Peg Version 3 *			55	114025
Type C Without Shield, Without Peg Version 4 *			55	114027
Type C Without Shield, Without Peg Version 5 *			55	114029







2.0 mm ERmet Hard Metric Connector System

Vertical Female Connectors Type C

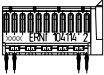

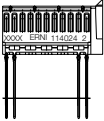
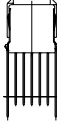
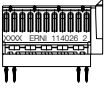
2.0 mm ERmet

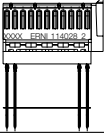
Ordering Information

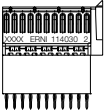
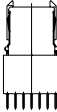
Configuration	Used For	No. of Pins	Part Number	
Type C With Shield, Without Peg Version 6 *			55	104114
Type C With Shield, Without Peg Version 7 *			55	114024
Type C With Shield, Without Peg Version 8 *			55	114026
Type C With Shield, Without Peg Version 9 *			55	114028
Type C With Shield, Without Peg Version 10 *			55	114030

2.0 mm ERmet Hard Metric Connector System

Right Angle Female Connectors Type D for Daughter Cards



176 signal contacts
50 mm with multifunction block (for positioning and coding)



The ERmet type D female connector provides 176 signal contacts and 44 ground shield contacts in a 8 row x 25 position (3 positions used by multifunction cavity), fully loaded configuration.

The connector provides for a gas tight, pressfit installation and is designed for two different configurations: with integrated upper ground return shields and without integrated upper ground return shields.

The ERmet type D female connector has a multifunction cavity that incorporates pre-alignment guides and accepts optional coding keys. This connector is designed to be used by itself or in conjunction with either a type E or F ERmet 2mm H.M. connector.

The type D female is also available with locating and strain relief peg that helps secure the connector to the printed circuit board (PCB).

Dimensional drawings and board hole pattern

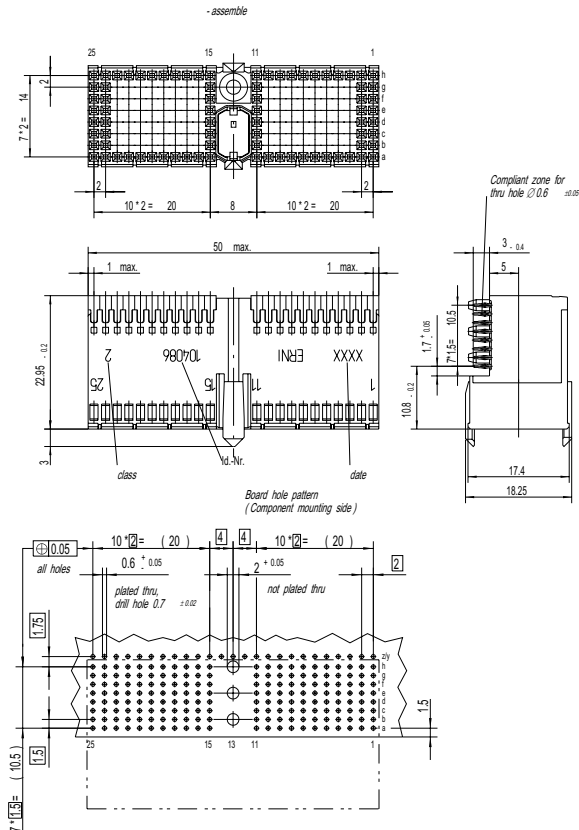

Note: The numbering on the connectors themselves is in accordance with the EC 61076-4-101 standard. All dimensions in mm.

2.0 mm ERmet Hard Metric Connector System

Right Angle Female Connectors Type D for Daughter Cards



2.0 mm ERmet

Ordering Information

Configuration	Used For	No. of Pins	Part Number
Type D Without Shield, With Peg 		176	104086
Type D With Shield, Without Peg 		176	104935
Type D With Upper Shield, With Peg 		176	104415
Lower Shield For Type D And DE 			103847

2.0 mm ERmet Hard Metric Connector System

Vertical Male Connectors Type D for Backplanes



176 signal contacts
50 mm with multifunction block (for positioning and coding)

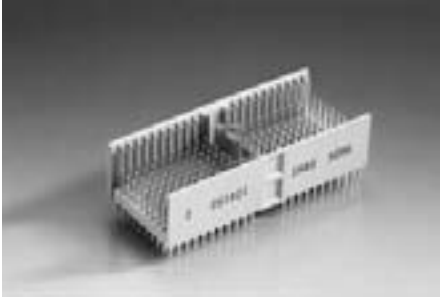

The ERmet type D vertical male connector provides up to 176 signal contacts and 44 ground shield contacts in 8+2 row x 25 position (3 positions used by multifunction cavity), fully loaded configuration. With 15 different standard pin lengths to choose from, this is one of the most versatile connectors available. The connector is designed for gas tight pressfit installation.

The ERmet type D male connector has a multifunction cavity that incorporates pre-alignment guides and accepts optional coding keys. This connector is designed to be used alone or in conjunction with either type E, DE or F ERmet 2mm H.M. connectors.

Dimensional drawings and board hole pattern

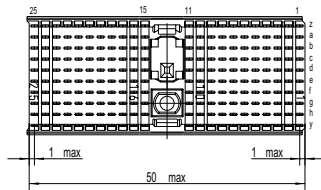
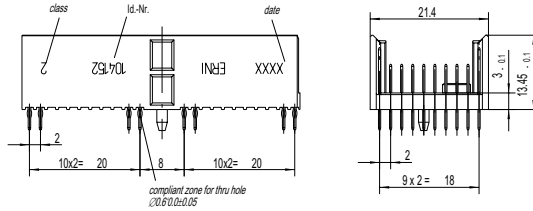

Lochbild fuer Leiterplatte (Bestueckungsseite) Board hole pattern (Component mounting side)

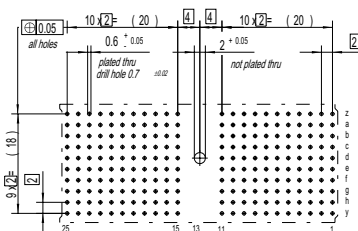

Note: The numbering on the connectors themselves is in accordance with the EC 61076-4-101 standard. All dimensions in mm.

2.0 mm ERmet Hard Metric Connector System

Vertical Male Connectors Type D for Backplanes



2.0 mm ERmet

Ordering Information

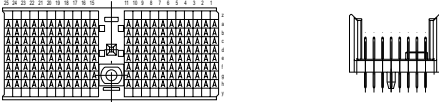
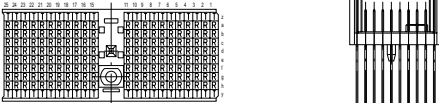
Configuration	Used For	No. of Pins	Part Number
Type D With Peg 		220	104152
Type D With Peg 		220	104517
Type D With Peg and Extended Terminals 		220	933008

Contact versions

ERNI can accommodate any pattern of male connector contact loading. For shield rows z and f (7 row connectors) or z and y (10 row connectors), level 3 contacts should be specified. For rear I/O and shrouds, choose contacts with the R1, R2 or R3 terminal length. Each contact has a unique letter designation. Use this letter designation when filling in the contact loading requirements on the ERNI Customer Request Form.

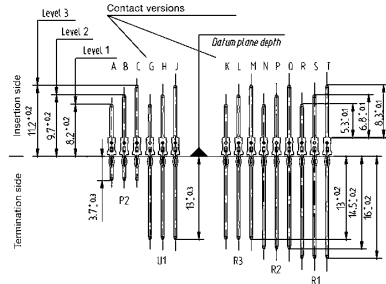

2.0 mm ERmet Hard Metric Connector System

Vertical Female Connectors Type D



176 signal contacts
50 mm with multifunction block (for positioning and coding)



The ERmet type D vertical female connector provides 176 signal contacts in a 8 row x 25 position (3 positions used by multifunction cavity), fully loaded configuration. The connector provides for a gas tight, pressfit installation and is designed for two different configurations: with and without integrated ground return shields. The ERmet type D vertical female connector has a multifunction cavity that incorporates pre-alignment guides and accepts optional coding keys. This connector is designed to be used by itself or in conjunction with either a type E or F ERmet 2mm H.M. connector.

Dimensional drawings and board hole pattern

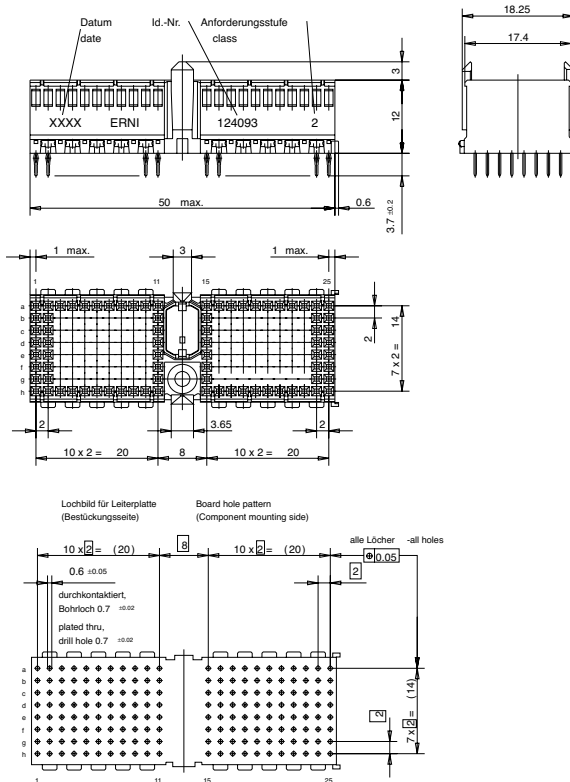

Note: The numbering on the connectors themselves is in accordance with the EC 61076-4-101 standard. All dimensions in mm.

2.0 mm ERmet Hard Metric Connector System

Vertical Female Connectors Type D



2.0 mm ERmet

Ordering Information

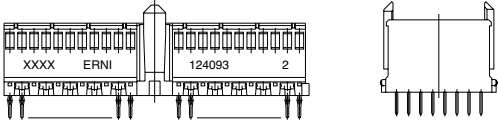
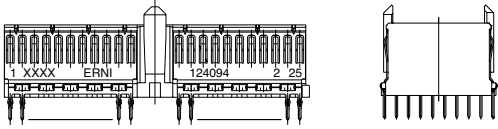
Configuration	Used For	No. of Pins	Part Number
<p>Type D Without Shield, Without Peg</p> 		176	124093
<p>Type D With Shield, Without Peg</p> 		176	124094

2.0 mm ERmet Hard Metric Connector System

Right Angle Female Connectors Type E for Daughter Cards



200 signal contacts
50 mm without multifunction block



The ERmet type E female connector provides 200 signal contacts and 50 ground shield contacts in a 8 row x 25 position fully loaded configuration.

The connector provides for a gas tight, pressfit installation and is designed for two different configurations: with integrated upper ground return shields and without integrated upper ground return shields.

The ERmet type E female connector has an uninterrupted pin field with no multifunction cavity. This connector is not designed to be used alone, but is intended to be used in conjunction with either a type D, DE or F ERmet 2mm H.M. connector.

Dimensional drawings and board hole pattern

Note: The numbering on the connectors themselves is in accordance with the EC 6 1076-4-101 standard. All dimensions in mm.

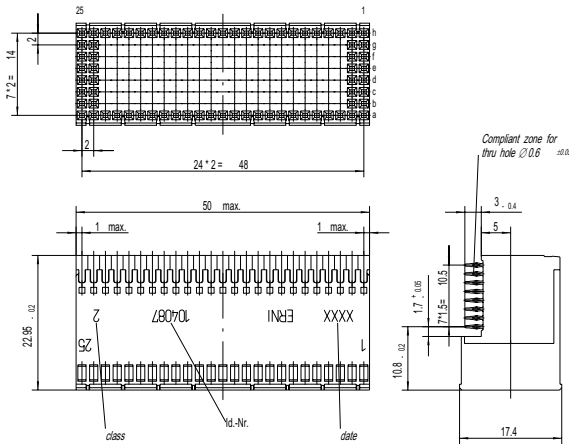

Board hole pattern
(Component mounting side)

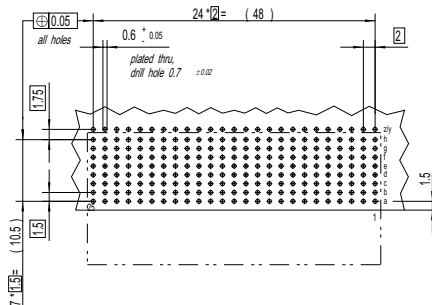



2.0 mm ERmet Hard Metric Connector System

Right Angle Female Connectors Type E for Daughter Cards

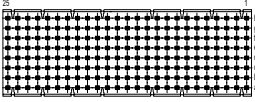
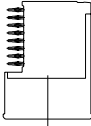
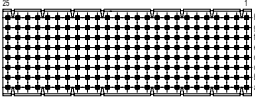
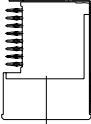
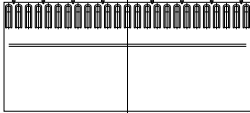

2.0 mm ERmet

Ordering Information

Configuration	Used For	No. of Pins	Part Number
Type E Without Shield, Without Peg  		200	104087
Type E With Upper Shield, Without Peg  		200	104416
Lower Shield For Type E  			103849

2.0 mm ERmet Hard Metric Connector System

Verticale Male Connectors Type E for Backplanes



200 signal contacts
50 mm without multifunction block



The ERmet type E vertical male connector provides 200 signal contacts and 50 ground shield contacts in an 8+2 row x 25 position fully loaded configuration. This connector is also available in an 8+2 row x 22 positions and 8+2 row x 19 positions. With 15 different standard pin lengths to choose from, this is one of the most versatile connectors available. The connector is designed for gas tight pressfit installation.

The ERmet type E vertical male connector has an uninterrupted pin field with no multifunction cavity. This connector is not designed to be used alone, but is intended to be used in conjunction with either type D, DE or F ERmet 2mm H.M. connectors.

Dimensional drawings and board hole pattern

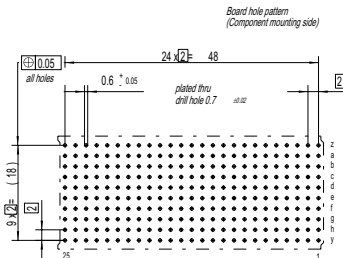
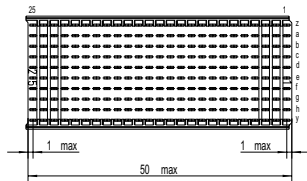
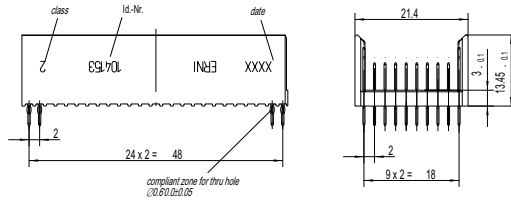

Note: The numbering on the connectors themselves is in accordance with the EC 6 1076-4-101 standard. All dimensions in mm.







2.0 mm ERmet Hard Metric Connector System

Verticale Male Connectors Type E for Backplanes

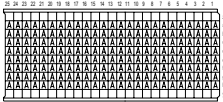

2.0 mm ERmet

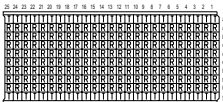
Ordering Information

Configuration	Used For	No. of Pins	Part Number
Type E Without Peg 		200	104518
Type E Without Peg 		250	104153
Type E Without Peg, With Extended Terminals 		250	933007

Contact versions

ERNI can accommodate any pattern of male connector contact loading. For shield rows z and f (7 row connectors) or z and y (10 row connectors), level 3 contacts should be specified. For rear I/O and shrouds, choose contacts with the R1, R2 or R3 terminal length. Each contact has a unique letter designation. Use this letter designation when filling in the contact loading requirements on the ERNI Customer Request Form.

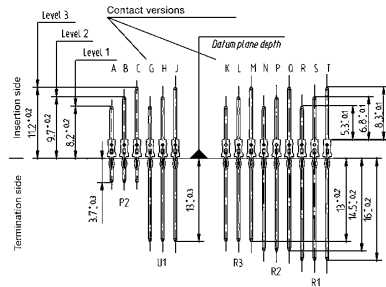

2.0 mm ERmet Hard Metric Connector System

Verticale Female Connectors Type E



200 signal contacts
50 mm without multifunction block



The ERmet type E vertical female connector provides 200 signal contacts in a 8 row x 25 position fully loaded configuration.

The connector provides for a gas tight, pressfit installation and is designed for two different configurations: with and without integrated ground return shields.

The ERmet type E vertical female connector has an uninterrupted pin field with no multifunction cavity. This connector is not designed to be used alone, but is intended to be used in conjunction with either a type D or F ERmet 2mm H.M. connector.

Dimensional drawings and board hole pattern

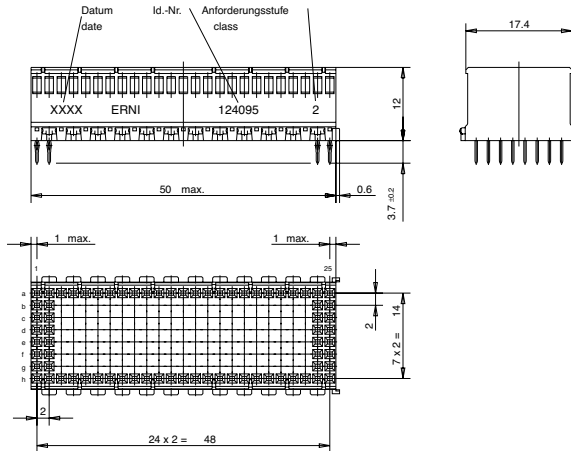

Note: The numbering on the connectors themselves is in accordance with the EC 61076-4-101 standard. All dimensions in mm.

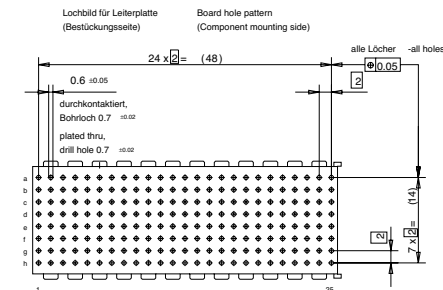

2.0 mm ERmet Hard Metric Connector System

Verticale Female Connectors Type E



2.0 mm ERmet

Ordering Information

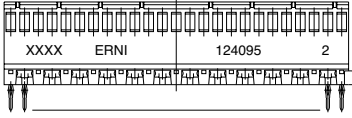
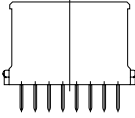
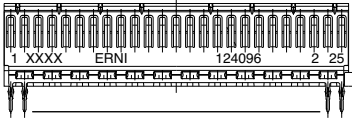
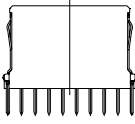
Configuration	Used For	No. of Pins	Part Number
<p>Type E Without Shield, Without Peg</p> 		200	124095
<p>Type E With Shield, Without Peg</p> 		200	124096

2.0 mm ERmet Hard Metric Connector System

Right Angle Female Connectors Type DE for Daughter Cards



200 signal contacts
50 mm without multifunction block



The ERmet type DE female connector provides 200 signal contacts and 25 ground shield contacts in an 8 row x 25 position fully loaded configuration.

The connector provides for a gas tight, pressfit installation and is designed for two different configurations: with integrated upper ground return shields and without integrated upper ground return shields.

The ERmet type DE female connector has an uninterrupted pin field and integral pre-alignment guide. This connector can be used alone or in conjunction with type D, E or F ERmet 2mm H.M. connector.

Dimensional drawings and board hole pattern

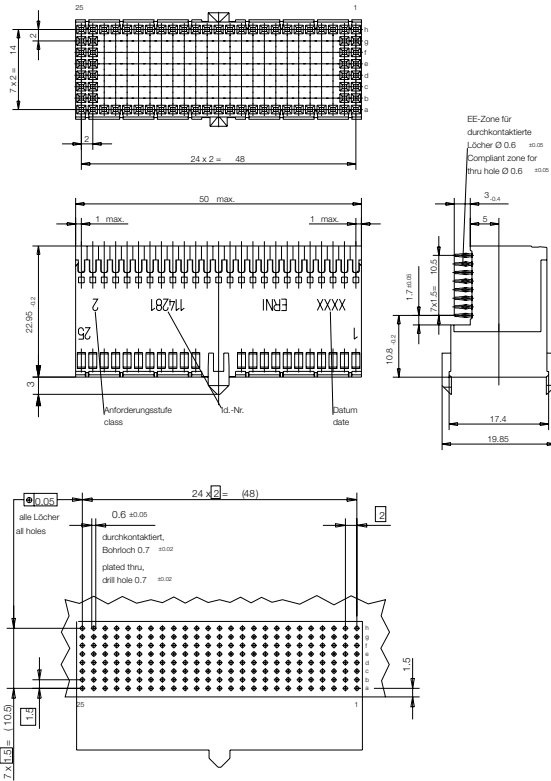

Note: The numbering on the connectors themselves is in accordance with the EC 61076-4-101 standard. All dimensions in mm.

2.0 mm ERmet Hard Metric Connector System

Right Angle Female Connectors Type DE for Daughter Cards



2.0 mm ERmet

Ordering Information

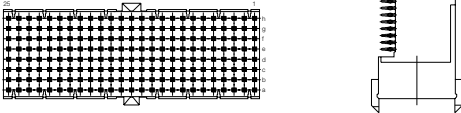
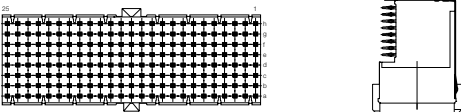
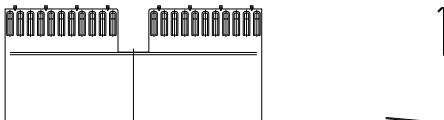
Configuration	Used For	No. of Pins	Part Number
Type DE Without Shield, Without Peg 		200	114281
Type DE With Shield, Without Peg 		200	124118
Lower Shield For Type D And DE 			103847

2.0 mm ERmet Hard Metric Connector System

Verticale Male Connectors Type DE for Backplanes



200 signal contacts
50 mm without multifunction block

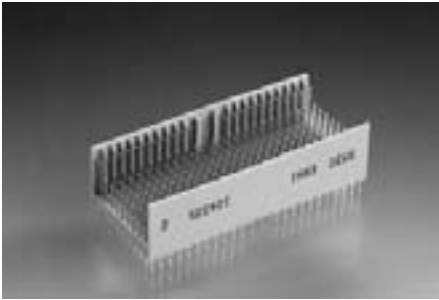

The ERmet type DE vertical male connector provides 200 signal contacts and 44 ground shield contacts in a 8+2 row x 25 position fully loaded configuration. With 15 different standard pin lengths to choose from, this is one of the most versatile connectors available. The connector is designed for gas tight pressfit installation. The ERmet type DE vertical male connector has an uninterrupted pin field with pre-alignment guides but does not accept coding keys. This connector can be used alone, or it can be used with either type D or F ERmet connectors.

Dimensional drawings and board hole pattern

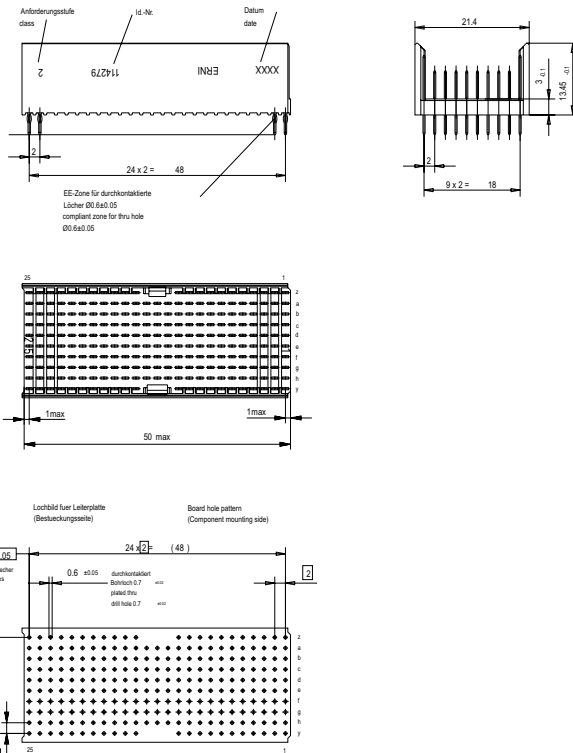

Note: The numbering on the connectors themselves is in accordance with the EC-61076-4-101 standard. All dimensions in mm.

2.0 mm ERmet Hard Metric Connector System

Verticale Male Connectors Type DE for Backplanes



2.0 mm ERmet

Ordering Information

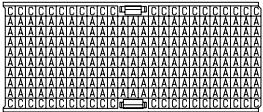
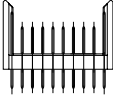
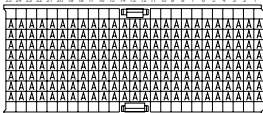
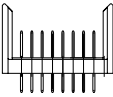
Configuration	Used For	No. of Pins	Part Number
Type DE Without Peg 		244	114279
Type DE Without Peg 		200	124335

Contact versions

ERNI can accommodate any pattern of male connector contact loading.

For shield rows z and f (7 row connectors) or z and y (10 row connectors), level 3 contacts should be specified. For rear I/O and shrouds, choose contacts with the R1, R2 or R3 terminal length. Each contact has a unique letter designation. Use this letter designation when filling in the contact loading requirements on the ERNI Customer Request Form.

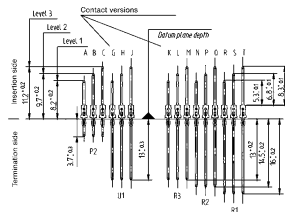

2.0 mm ERmet Hard Metric Connector System

Right Angle Female Connectors Type F for Daughter Cards



88 signal contacts
25 mm extension module



The ERmet type F female connector provides 88 signal contacts and 22 ground shield contacts in an 8 row x 11 position fully loaded configuration.

The connector provides for a gas tight, pressfit installation and is designed for two different configurations: with and without integrated ground return shields.

The ERmet type F female connector has integral pre-alignment guides but no multifunction cavity.

The type F female is also available with optional locating and strain relief pegs that help secure the connector to the printed circuit board (PCB). This connector is designed to be used alone or with either type D, DE or E ERmet connectors, however it can only be installed at the lower end of a connector field.

Dimensional drawings and board hole pattern

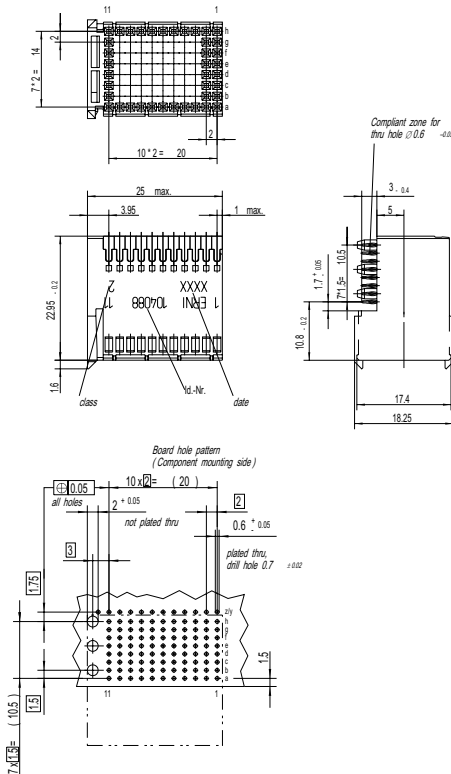

Note: The numbering on the connectors themselves is in accordance with the EC 61076-4-101 standard. All dimensions in mm.

2.0 mm ERmet Hard Metric Connector System

Right Angle Female Connectors Type F for Daughter Cards



2.0 mm ERmet

Ordering Information

Configuration	Used For	No. of Pins	Part Number
Type F Without Shield, With Peg		88	104088
Type F With Shield, With Peg		88	104417
Lower Shield For Type F			103851

2.0 mm ERme Hard Metric Connector System

Verticale Male Connectors Type F for Backplanes



88 signal contacts
25 mm extension module



The ERmet type F vertical male connector provides 88 signal contacts and 22 ground shield contacts in a 8+2 row x 11, fully loaded configuration. With 15 different standard pin lengths to choose from, this is one of the most versatile connectors available. The connector is designed for gas tight pressfit installation.

The ERmet type F vertical male connector incorporates pre-alignment guides but has no multifunction cavity. This connector is designed to be used alone. The type F connector can also be used in conjunction with either a type D, E, or DE ERmet connector, however, it can only be installed at the lower end of a connector row.

Dimensional drawings and board hole pattern

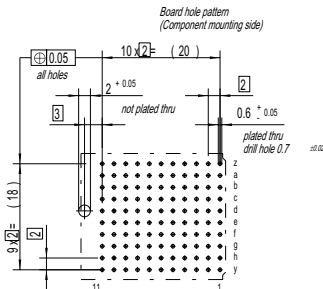
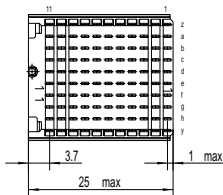
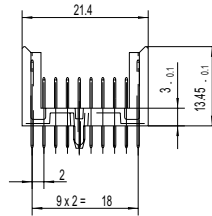
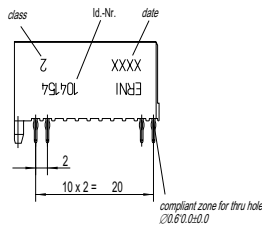

Note: The numbering on the connectors themselves is in accordance with the EC-61076-4-101 standard. All dimensions in mm.





2.0 mm ERmet Hard Metric Connector System

Verticale Male Connectors Type F for Backplanes

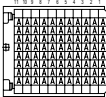

2.0 mm ERmet

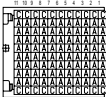
Ordering Information

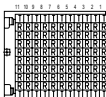
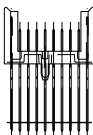
Configuration	Used For	No. of Pins	Part Number
Type F With Peg  		88	104519
Type F With Peg  		110	104154
Type F With Peg And Extended Terminals  		110	933006

Contact versions

ERNI can accommodate any pattern of male connector contact loading. For shield rows z and f (7 row connectors) or z and y (10 row connectors), level 3 contacts should be specified. For rear I/O and shrouds, choose contacts with the R1, R2 or R3 terminal length. Each contact has a unique letter designation. Use this letter designation when filling in the contact loading requirements on the ERNI Customer Request Form.

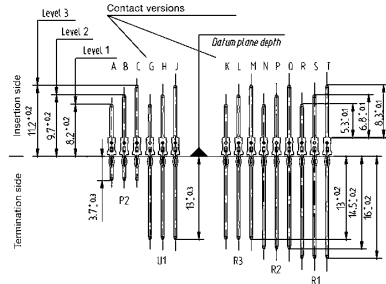

2.0 mm ERmet Hard Metric Connector System

Verticale Female Connectors Type F



88 signal contacts
25 mm extension module



The ERmet type F vertical female connector provides 88 signal contacts and in an 8 row x 11 position fully loaded configuration.

The connector provides for a gas tight, pressfit installation and is designed for two different configurations: with and without integrated ground return shields.

The ERmet type F vertical female connector has integral pre-alignment guides but no multifunction cavity. This connector is designed to be used alone or with either type D or E ERmet connectors, however it can only be installed at the lower end of a connector field.

Dimensional drawings and board hole pattern

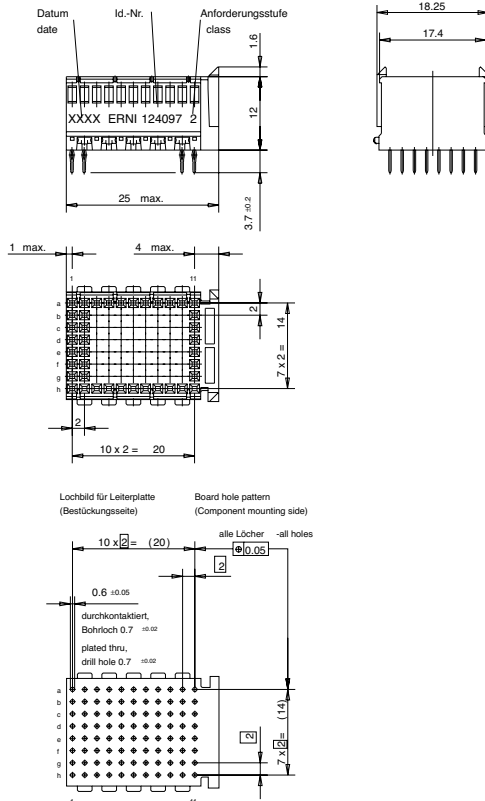

Note: The numbering on the connectors themselves is in accordance with the EC 61076-4-101 standard. All dimensions in mm.

2.0 mm ERmet Hard Metric Connector System

Verticale Female Connectors Type F



2.0 mm ERmet

Ordering Information

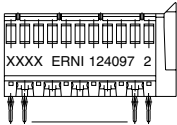
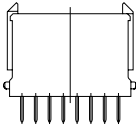
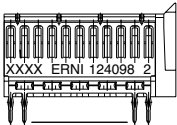
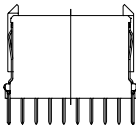
Configuration	Used For	No. of Pins	Part Number
Type F Without Shield, Without Peg 		88	124097
Type F With Shield, Without Peg 		88	124098

2.0 mm ERmet Hard Metric Connector System

Right Angle Female Connectors Type L for Daughter Cards



6 special contacts
 50 mm with multifunction block (for positioning and coding)



The ERmet type L female is an insulator that provides up to 6 contact positions for special power or coax contacts in a fully loaded configuration.

The ERmet type L female connector has a multifunction cavity that incorporates pre-alignment guides and accepts optional coding keys. This connector is designed to be used alone or in conjunction with either a type B, C, M or N ERmet connector.

The type L female is also available with a locating and strain relief peg that helps secure the connector to the printed circuit board (PCB).

Dimensional drawings and board hole pattern

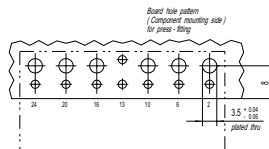
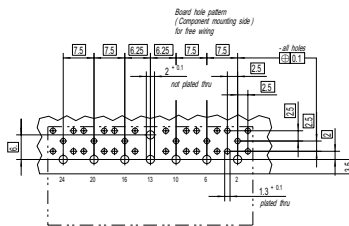
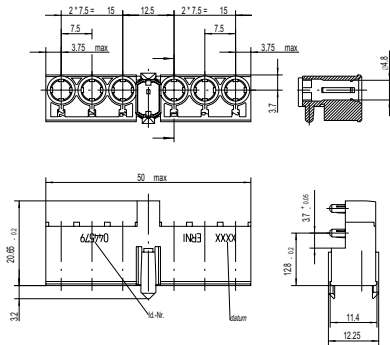

Note: The numbering on the connectors themselves is in accordance with the EC 61076-4-101 standard. All dimensions in mm.

2.0 mm ERmet Hard Metric Connector System

Right Angle Female Connectors Type L for Daughter Cards



2.0 mm ERmet

Ordering Information

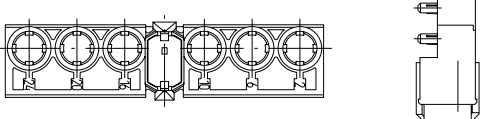
Configuration	Used For	No. of Pins	Part Number
<p>Type L with 6 cavities for special contacts</p> 			<p>044579</p>

2.0 mm ERmet Hard Metric Connector System

Verticale Male Connectors Type L for Backplanes



6 special contacts
50 mm with multifunction block

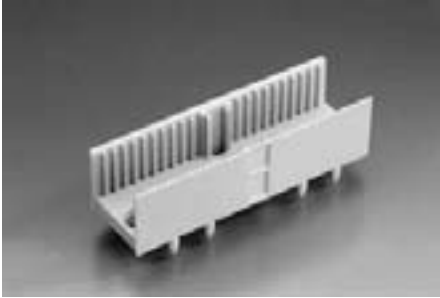

The ERmet type L male connector is an insulation body that could be loaded with up to 6 special power or coax contacts in a fully loaded configuration. The ERmet type L male connector has a multifunction cavity that incorporates pre-alignment guides and accepts optional coding keys. This connector is designed to be used alone or in conjunction with either a type B, C, M, or N ERmet connector. The type L male is available with a locating peg that helps secure the connector to the printed circuit board (PCB).

Dimensional drawings and board hole pattern

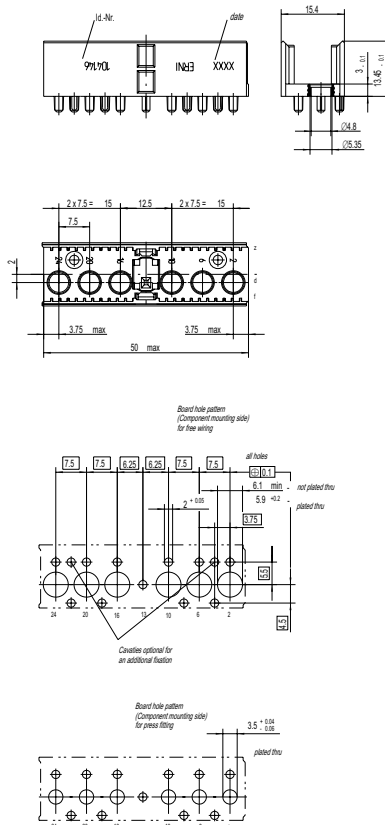

Note: The numbering on the connectors themselves is in accordance with the EC 61076-4-101 standard. All dimensions in mm.

2.0 mm ERmet Hard Metric Connector System

Verticale Male Connectors Type L for Backplanes



2.0 mm ERmet

Ordering Information

Configuration	Used For	No. of Pins	Part Number
Type L with 6 cavities for special contacts			104146

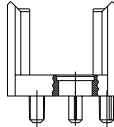
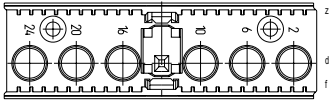

Contact versions

ERNI can accommodate any pattern of male connector contact loading.

For shield rows z and f (7 row connectors) or z and y (10 row connectors), level 3 contacts should be specified. For rear I/O and shrouds, choose contacts with the R1, R2 or R3 terminal length. Each contact has a unique letter designation. Use this letter designation when filling in the contact loading requirements on the ERNI Customer Request Form.

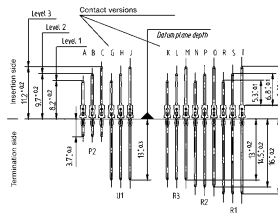

2.0 mm ERmet Hard Metric Connector System

Right Angle Female Connectors Type M for Daughter Cards



3 special and 55 signal contacts
50 mm with multifunction block

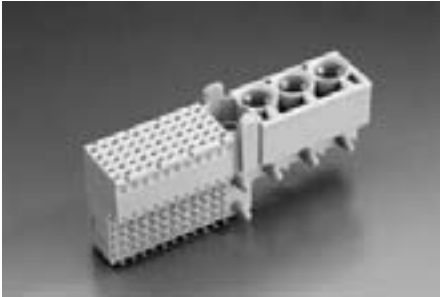

The ERmet type M female connector provides 55 contacts in a 5 row x 11 position (3 positions used by multifunction cavity), and also 3 contact positions for special power or coax contacts in a fully loaded configuration.

The connector is designed for gas tight, pressfit installation and is provided in two different configurations: with and without integrated upper ground return shields. Lower ground return shields are also available separately.

The ERmet type M female connector has a multifunction cavity that incorporates pre-alignment guides and accepts optional coding keys. This connector can be used alone or in conjunction with either a type A, B, C, L, or N ERmet connector.

The type M female is also available with a center pair of locating and strain relief pegs that help secure the connector to the printed circuit board (PCB).

Dimensional drawings and board hole pattern

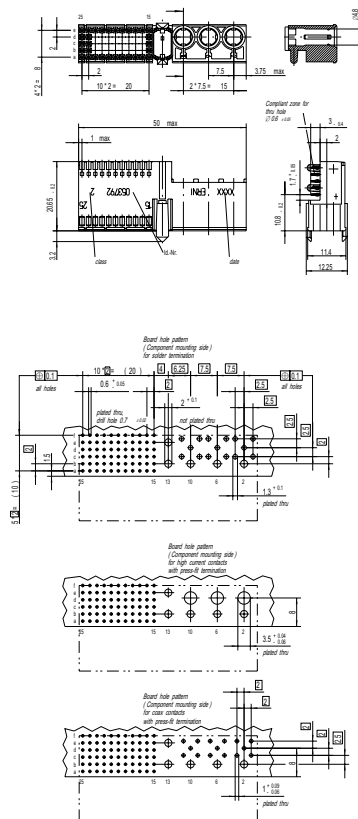

Note: The numbering on the connectors themselves is in accordance with the EC 61076-4-101 standard. All dimensions in mm.

2.0 mm ERmet Hard Metric Connector System

Right Angle Female Connectors Type M for Daughter Cards



2.0 mm ERmet

Ordering Information

Configuration	Used For	No. of Pins	Part Number
<p>Type M With 3 Cavities For Special Contacts</p>		55-3	053792
<p>Type M With 3 Cavities For Special Contacts With Upper Shield With Peg</p>		55-3	103804
<p>Lower Shield For Type M</p>			054354

2.0 mm ERmet Hard Metric Connector System

Verticale Male Connectors Type M for Backplanes



3 special and 55 signal contacts
50 mm with multifunction block

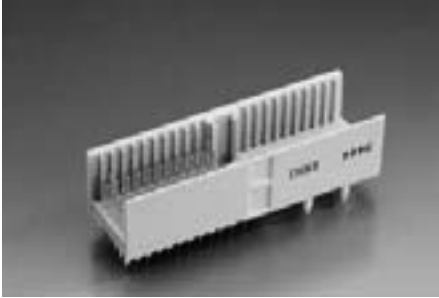

The ERmet male connector type M provides a maximum of 77 contacts in 7 rows by 11 positions. The two outer rows, z and f are for the shielding contacts of the male connector, along with 3 contact positions for special power or coax contacts. This type contains a multifunction cavity for coding and pre-alignment in the center position. This connector is designed to be used alone or in conjunction with either a type B, C, L, or N ERmet connector. The type M male is available with a locating peg that helps secure the connector to the printed circuit board (PCB).

Dimensional drawings and board hole pattern

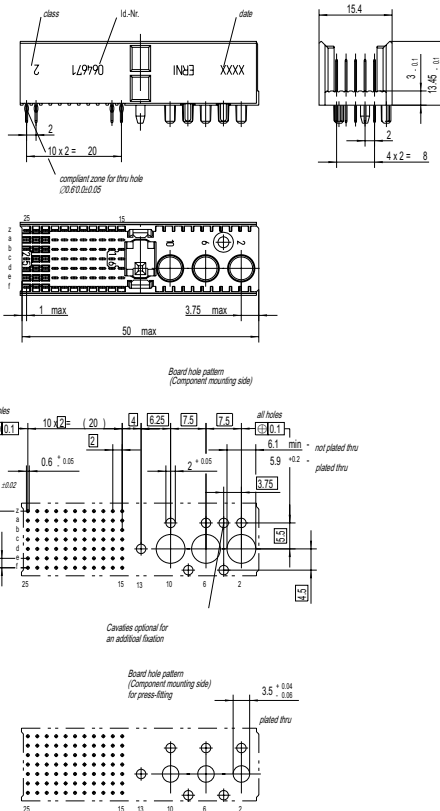

Note: The numbering on the connectors themselves is in accordance with the EC 61076-4-101 standard. All dimensions in mm.

2.0 mm ERmet Hard Metric Connector System

Verticale Male Connectors Type M for Backplanes



2.0 mm ERmet

Ordering Information

Configuration	Used For	No. of Pins	Part Number
Type M With 3 Cavities For Special Contacts 		77-3	054087
Type M With 3 Cavities For Special Contacts 		55-3	064671

Contact versions

ERNI can accommodate any pattern of male connector contact loading.

For shield rows z and f (7 row connectors) or z and y (10 row connectors), level 3 contacts should be specified. For rear I/O and shrouds, choose contacts with the R1, R2 or R3 terminal length. Each contact has a unique letter designation. Use this letter designation when filling in the contact requirements on the ERNI Customer Request Form.

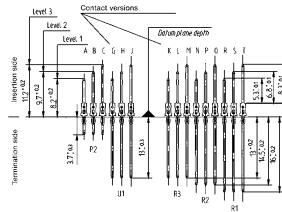

2.0 mm ERmet Hard Metric Connector System

Right Angle Female Connectors Type N for Daughter Cards



3 cavities for special contacts
 25 mm extension module



The ERmet female connector type N is a connector housing with 3 contact positions for special power or coax contacts. The type N female is available with a locating and strain relief peg that helps secure the connector to the printed circuit board (PCB).

Dimensional drawings and board hole pattern

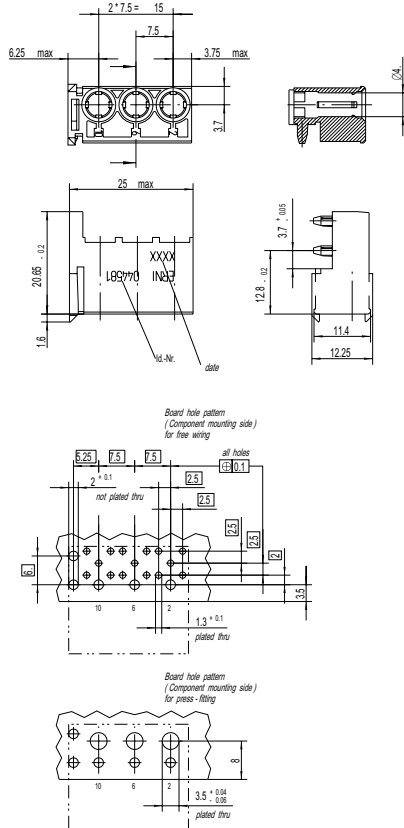

Note: The numbering on the connectors themselves is in accordance with the EC 6 1076-4-101 standard. All dimensions in mm.



2.0 mm ERmet Hard Metric Connector System

Right Angle Female Connectors Type N for Daughter Cards

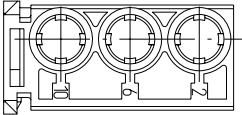

2.0 mm ERmet

Ordering Information

Configuration	Used For	No. of Pins	Part Number
<p>Type N With 3 Cavities For Special Contacts</p> 			<p>044581</p>

2.0 mm ERmet Hard Metric Connector System

Verticale Male Connectors Type N for Backplanes



3 cavities for special contacts
25 mm extension module

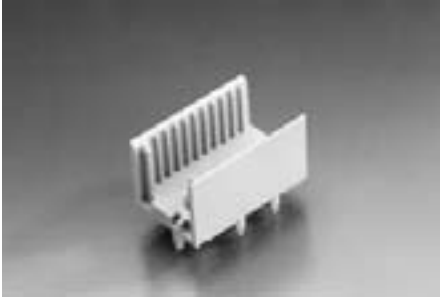

The ERmet type N male connector is a connector housing with 3 contact positions for special coax or high power contacts.

The type N male is available with a locating and strain relief peg that helps secure the connector to the printed circuit board (PCB).

Dimensional drawings and board hole pattern

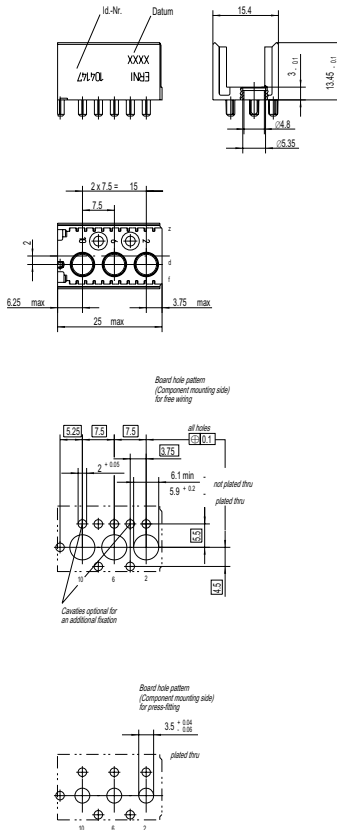

Note: The numbering on the connectors themselves is in accordance with the EC 61076-4-101 standard. All dimensions in mm.

2.0 mm ERmet Hard Metric Connector System

Verticale Male Connectors Type N for Backplanes



2.0 mm ERmet

Ordering Information

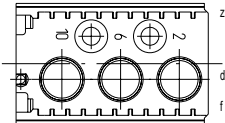
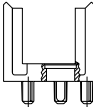
Configuration	Used For	No. of Pins	Part Number
3 cavities for special contacts  			104147

Contact versions

ERNI can accommodate any pattern of male connector contact loading.

For shield rows z and f (7 row connectors) or z and y (10 row connectors), level 3 contacts should be specified. For rear I/O and shrouds, choose contacts with the R1, R2 or R3 terminal length. Each contact has a unique letter designation. Use this letter designation when filling in the contact loading requirements on the ERNI Customer Request Form.

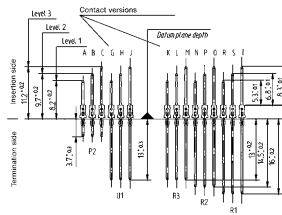

2.0 mm ERmet Hard Metric Connector System

Shrouds Type A for Backplanes



The ERmet shroud type A is possible for a maximum of 175 contacts in 7 rows by 25 positions. The two outer rows, z and f are for the shielding contacts of the female connector. This type contains a multifunction block for coding and pre-alignment which uses 3 positions. For CompactPCI applications the shroud type A is used on the position rP1 and rP4.

Dimensional drawings

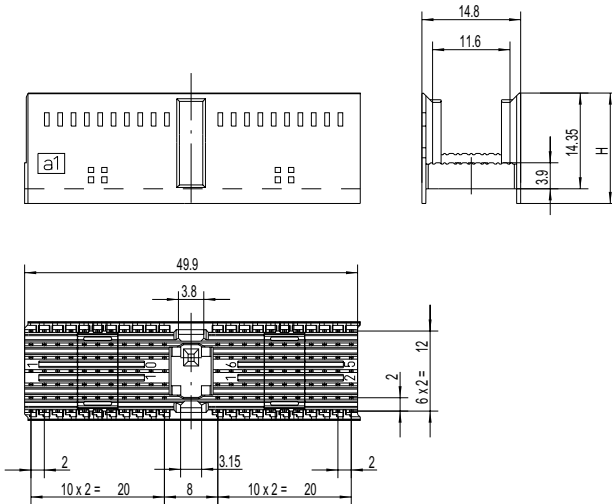

H	Ident-Nr. / Part No.
14.35	114436
14.95	054795
15.75	054794
16.55	054793

Sammelzeichnung
Combination Drawing

Note: All dimensions in mm.



2.0 mm ERmet Hard Metric Connector System

Shrouds Type A for Backplanes

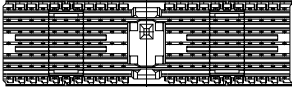
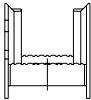
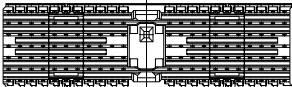
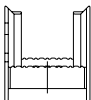
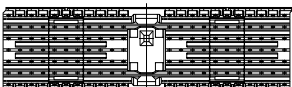

2.0 mm ERmet

Ordering Information

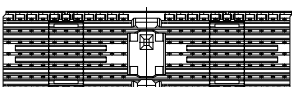
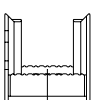
Configuration	Used For	No. of Pins	Part Number
Type A Shroud 25 Positions 	Height 14.35 	CompactPCI™ rP1, rP4	114436
Type A Shroud 25 Positions 	Height 14.95 	CompactPCI™ rP1, rP4	054795
Type A Shroud 25 Positions 	Height 15.75 	CompactPCI™ rP1, rP4	054794
Type A Shroud 25 Positions 	Height 16.55 	CompactPCI™ rP1, rP4	054793

2.0 mm ERmet Hard Metric Connector System

Shrouds Type A for Backplanes

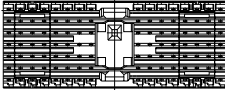
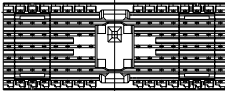
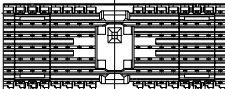
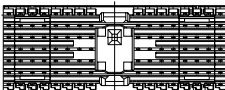

Ordering Information

Configuration	Used For	No. of Pins	Part Number
Type A Shroud 19 Positions 	Height 14.35		124312
Type A Shroud 19 Positions 	Height 14.95		923109
Type A Shroud 19 Positions 	Height 15.75		923108
Type A Shroud 19 Positions 	Height 16.55		923107

2.0 mm ERmet Hard Metric Connector System

Shrouds Type B for Backplanes



2.0 mm ERmet



The ERmet™ shroud type B is possible for a maximum of 175 contacts in 7 rows by 25 positions. The two outer rows, z and f are for the shielding contacts of the female connector. For this type, without multifunton block for coding and pre-alignment, we recommend use only in combination with types A or C.

Dimensional drawings

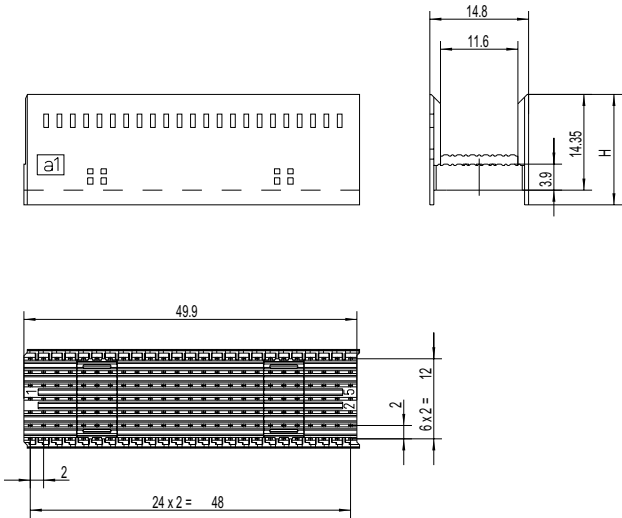

H	Ident-Nr. / Part No.
14.35	114437
14.95	054797
15.75	054798
16.55	054799

Sammelzeichnung
Combination Drawing

Note: All dimensions in mm.

2.0 mm ERmet Hard Metric Connector System

Shrouds Type B for Backplanes

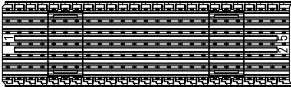
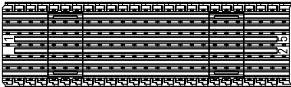
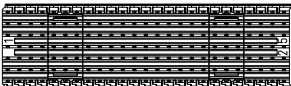
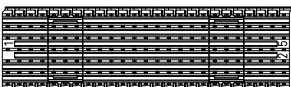

Ordering Information

Configuration	Used For	No. of Pins	Part Number
Type B Shroud 25 Positions 	Height 14.35		114437
Type B Shroud 25 Positions 	Height 14.95		054797
Type B Shroud 25 Positions 	Height 15.75		054798
Type B Shroud 25 Positions 	Height 16.55		054799

2.0 mm ERmet Hard Metric Connector System

Shrouds Type B for Backplanes



2.0 mm ERmet

Ordering Information

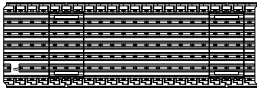
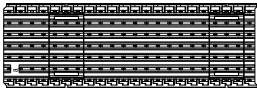
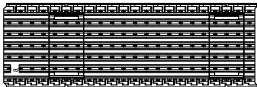
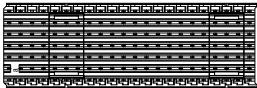
Configuration	Used For	No. of Pins	Part Number
Type B Shroud 22 Positions 	Height 14.35		114619
Type B Shroud 22 Positions 	Height 14.95		064692
Type B Shroud 22 Positions 	Height 15.75		064693
Type B Shroud 22 Positions 	Height 16.55		064694

2.0 mm ERmet Hard Metric Connector System

Shrouds Type B for Backplanes

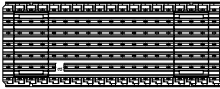
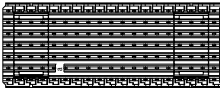
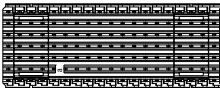
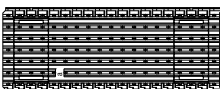

Ordering Information

Configuration	Used For	No. of Pins	Part Number
Type B Shroud 19 Positions 	Height 14.35		114618
Type B Shroud 19 Positions 	Height 14.95		064622
Type B Shroud 19 Positions 	Height 15.75		064623
Type B Shroud 19 Positions 	Height 16.55		064624

2.0 mm ERmet Hard Metric Connector System

Shrouds Type C for Backplanes



2.0 mm ERmet



The ERmet shroud type C is possible for a maximum of 77 contacts in 7 rows by 11 positions with the length of 25 mm. The two outer rows, z and f are for the shielding contacts of the female connector.

Dimensional drawings

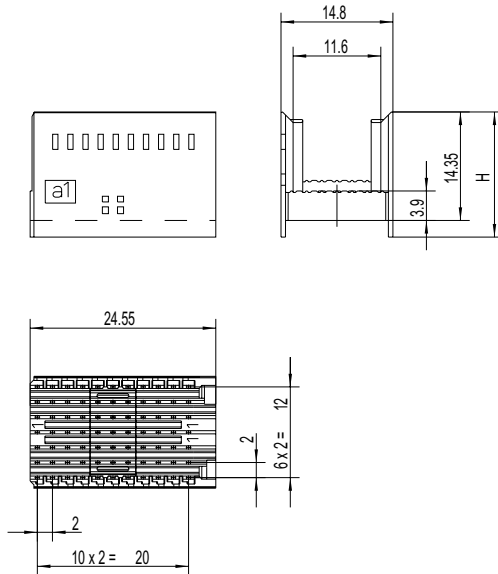

H	Ident-Nr. / Part No.
14.35	114438
14.95	064172
15.75	064171
16.55	064170

Sammelzeichnung
Combination Drawing





Note: All dimensions in mm.

2.0 mm ERmet Hard Metric Connector System

Shrouds Type C for Backplanes

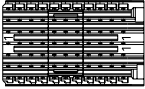

Ordering Information

Configuration	Used For	No. of Pins	Part Number
Type C Shroud 11 Positions 	Height 14.35		114438
Type C Shroud 11 Positions 	Height 14.95		064172
Type C Shroud 11 Positions 	Height 15.75		064171
Type C Shroud 11 Positions 	Height 16.55		064170

2.0 mm ERmet Hard Metric Connector System

Shrouds Type AB for Backplanes



2.0 mm ERmet

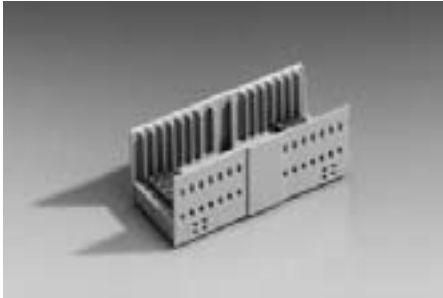

The ERmet shroud type AB is possible for a maximum of 169 contacts in 7 rows by 25 positions. The two outer rows, z and f are for the shielding contacts of the female connector. This type has pre-alignment flanges but no multi-function block for coding.

The male shroud type AB, is also available in a smaller version for planned CompactPCI applications, it is used at the locations rP2 and rP5 with 154, respectively, 110 contacts at 22 positions and on location rP3 with 133 respectively, 95 contacts at 19 positions.

Dimensional drawings

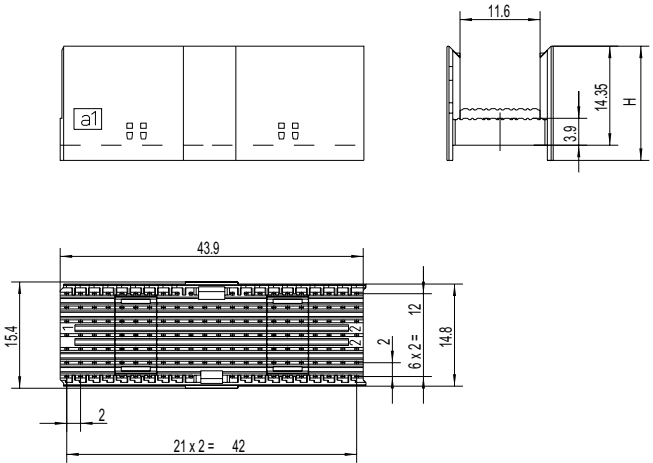

H	Ident-Nr. / Part No.
14.35	114425
14.95	114426
15.75	114427
16.55	114428

Sammelzeichnung
Combination Drawing

Note: All dimensions in mm.

2.0 mm ERmet Hard Metric Connector System

Shrouds Type AB for Backplanes

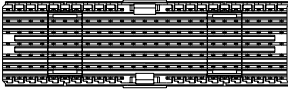
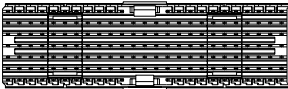
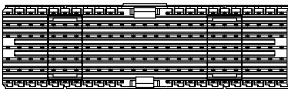
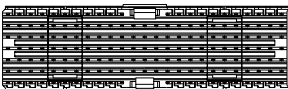

Ordering Information

Configuration	Used For	No. of Pins	Part Number
Type AB Shroud 25 Positions 	Height 14.35		114482
Type AB Shroud 25 Positions 	Height 14.95		114483
Type AB Shroud 25 Positions 	Height 15.75		114484
Type AB Shroud 25 Positions 	Height 16.55		114485







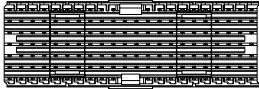

2.0 mm ERmet Hard Metric Connector System

Shrouds Type AB for Backplanes

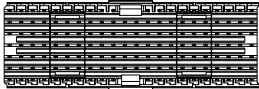

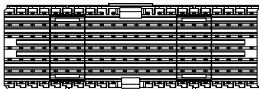
2.0 mm ERmet

Ordering Information

Configuration	Used For	No. of Pins	Part Number
Type AB Shroud 22 Positions 	Height 14.35  <i>CompactPCI™</i> rP2, rP5		114425
Type AB Shroud 22 Positions 	Height 14.95  <i>CompactPCI™</i> rP2, rP5		114426
Type AB Shroud 22 Positions 	Height 15.75  <i>CompactPCI™</i> rP2, rP5		114427
Type AB Shroud 22 Positions 	Height 16.55  <i>CompactPCI™</i> rP2, rP5		114428

2.0 mm ERmet Hard Metric Connector System

Shrouds Type AB for Backplanes

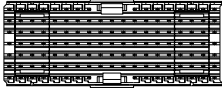
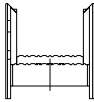
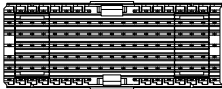
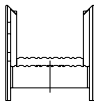
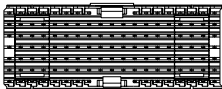
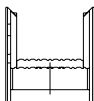
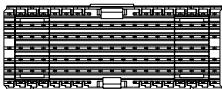
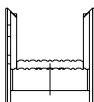

Ordering Information

Configuration		Used For	No. of Pins	Part Number
Type AB Shroud 19 Positions	Height 14.35	CompactPCI™		
		rP3		114487
Type AB Shroud 19 Positions	Height 14.95	CompactPCI™		
		rP3		114488
Type AB Shroud 19 Positions	Height 15.75	CompactPCI™		
		rP3		114489
Type AB Shroud 19 Positions	Height 16.55	CompactPCI™		
		rP3		114490

2.0 mm ERmet Hard Metric Connector System

Shrouds Type D for Backplanes



2.0 mm ERmet

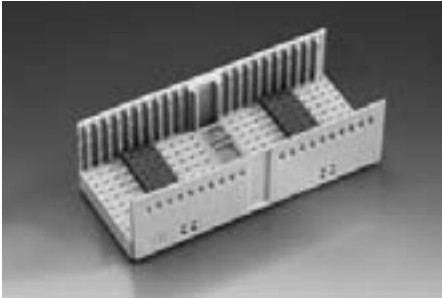

The ERmet shroud type D is possible for a maximum of 220 contacts in 10 rows by 25 positions with the length of 50 mm. The two outer rows, z and y are for the shielding contacts of the female connector. This type contains a multi-function block for coding and pre-alignment which uses 3 positions

Dimensional drawings

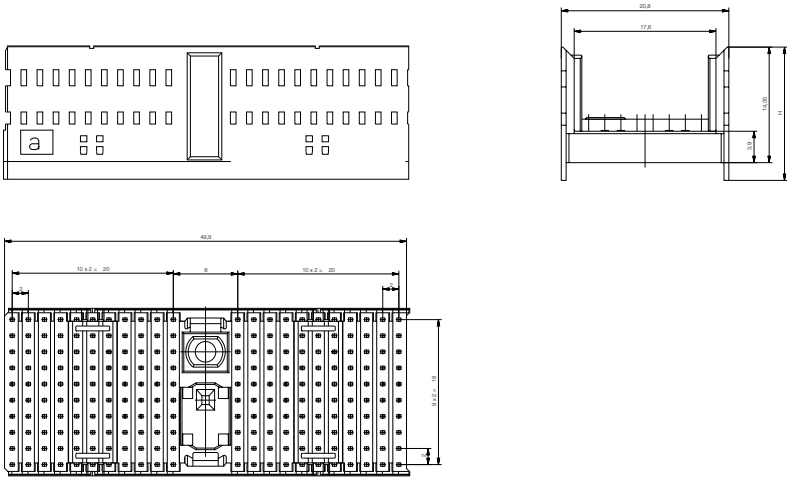

H	Ident-Nr. / Part No.
14.35	114467
14.95	114468
15.75	114469
16.55	114470

Note: All dimensions in mm.

2.0 mm ERmet Hard Metric Connector System

Shrouds Type D for Backplanes

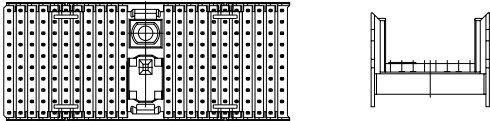
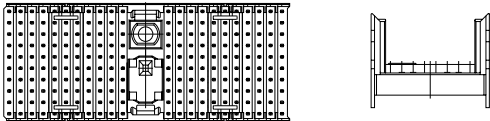
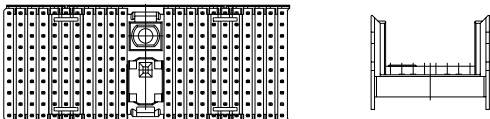
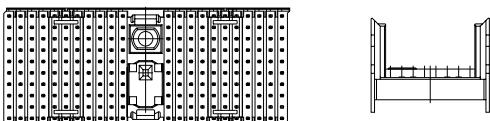

Ordering Information

Configuration	Used For	No. of Pins	Part Number
Type D Shroud 25 Positions 	Height 14.35		114467
Type D Shroud 25 Positions 	Height 14.95		114468
Type D Shroud 25 Positions 	Height 15.75		114469
Type D Shroud 25 Positions 	Height 16.55		114470

2.0 mm ERmet Hard Metric Connector System

Shrouds Type E for Backplanes



2.0 mm ERmet

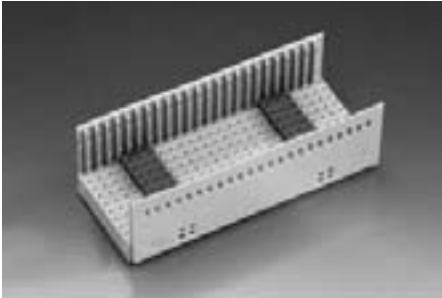

The ERmet shroud type E is possible for a maximum of 220 contacts in 10 rows by 25 positions with the length of 50 mm. The two outer rows, z and y are for the shielding contacts of the female connector. For this type; without multi-function block for coding and pre-alignment, we recommend use only in combination with types D or F.

Dimensional drawings

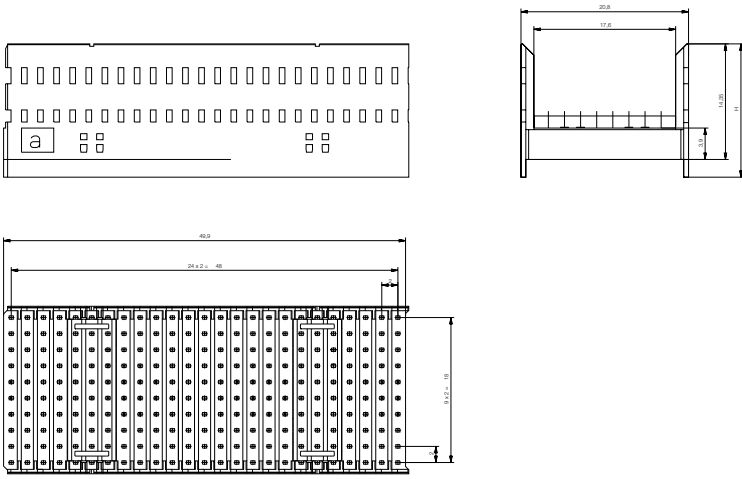

H	Ident-Nr. / Part No.
14.35	114472
14.95	114473
15.75	114474
16.55	114475

Note: All dimensions in mm.

2.0 mm ERmet Hard Metric Connector System

Shrouds Type E for Backplanes

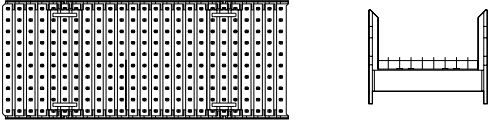
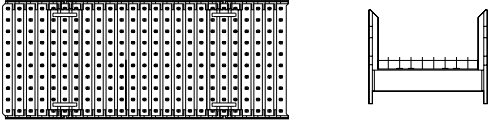
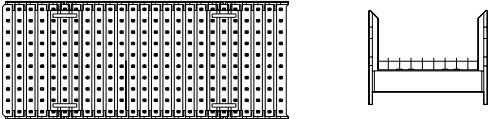
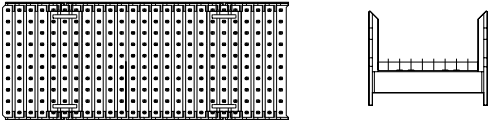

Ordering Information

Configuration	Used For	No. of Pins	Part Number
Type E Shroud 25 Positions 	Height 14.35		114472
Type E Shroud 25 Positions 	Height 14.95		114473
Type E Shroud 25 Positions 	Height 15.75		114474
Type E Shroud 25 Positions 	Height 16.55		114475

2.0 mm ERmet Hard Metric Connector System

Shrouds Type F for Backplanes



2.0 mm ERmet

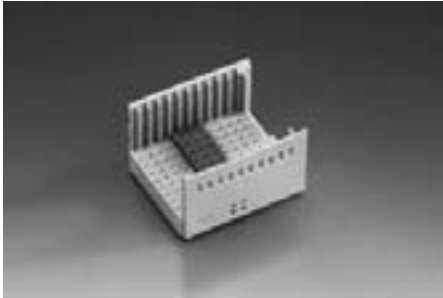

The ERmet shroud type F is possible for a maximum of 110 contacts in 10 rows by 11 positions with the length of 25 mm. The two outer rows, z and y are for the shielding contacts of the female connector.

Dimensional drawings

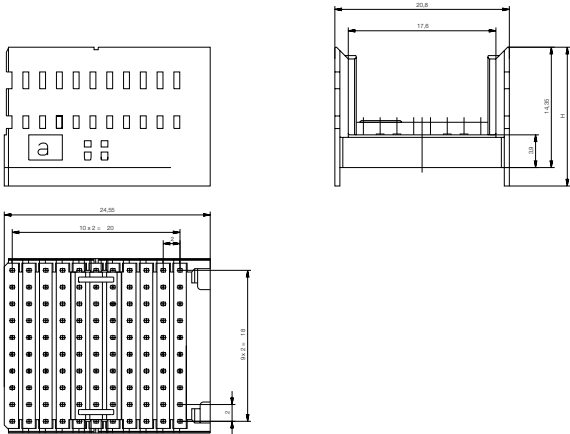

H	Ident-Nr. / Part No.
14.35	114477
14.95	114478
15.75	114479
16.55	114480

Note: All dimensions in mm.

2.0 mm ERmet Hard Metric Connector System

Shrouds Type F for Backplanes

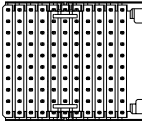
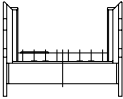
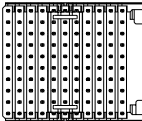
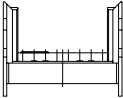
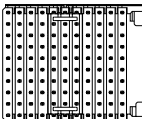
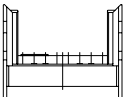
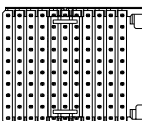
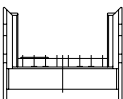

Ordering Information

Configuration	Used For	No. of Pins	Part Number
Type F Shroud 11 Positions 	Height 14.35 		114477
Type F Shroud 11 Positions 	Height 14.95 		114478
Type F Shroud 11 Positions 	Height 15.75 		114479
Type F Shroud 11 Positions 	Height 16.55 		114480

2.0 mm ERmet Hard Metric Connector System

Right Angle Female Monoblock Modules



2.0 mm ERmet

220 signal contacts
94 mm with multifunction block

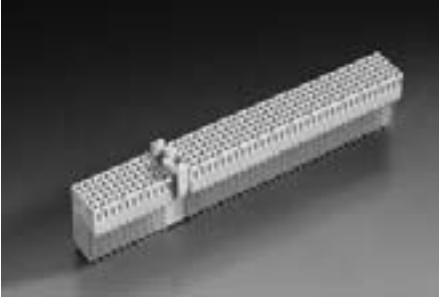

The ERmet™ female monoblock connector integrates the type A and the type B modules into one single piece. The monoblock provides a maximum of 220 contacts in 5 rows by 44 positions. The monoblock has integrated pre-centering and as an option integrated coding, acc. to PICMG Spec. for 3.3V or 5.0V, which requires 3 positions. For applications requiring the use of shielding, the female connector is supplied with a with an upper shield. Lower shield may be ordered separately. The monoblock has been designed especially for CompactPCI applications for the positions P1/P2 and for the positions P4/P5. The monoblock has a length of 94mm (3U) and can also be used for other applications in 19" rack systems.

Dimensional drawings

Note: The numbering on the connectors themselves is in accordance with the EC 61076-4-101 standard. All dimensions in mm.

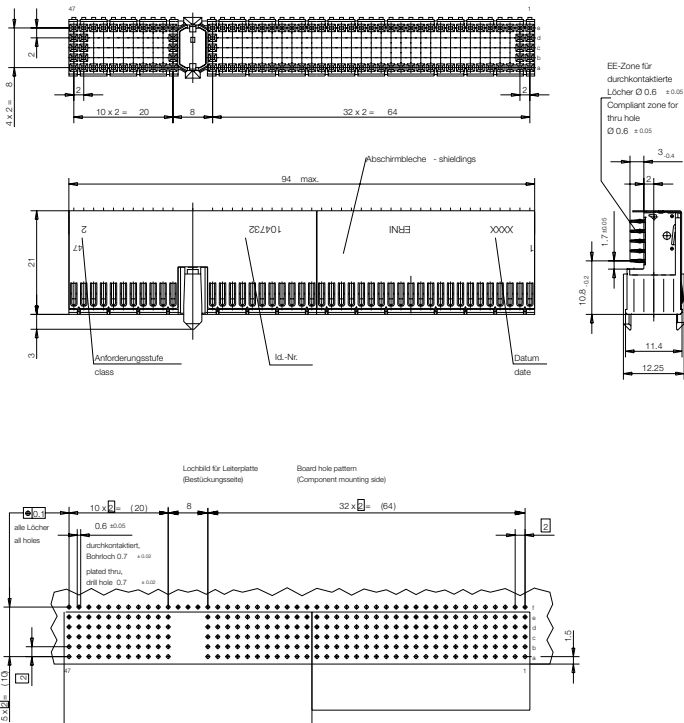

2.0 mm ERmet Hard Metric Connector System

Right Angle Female Monoblock Modules

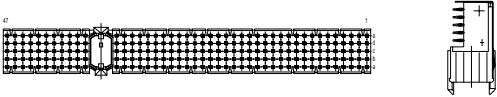
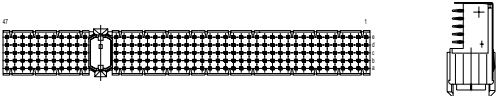
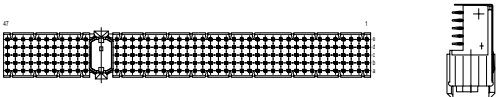

Ordering Information

Configuration	Used For	No. of Pins	Part Number
Monoblock With Shield, Without Peg 	CompactPCI™ J4/J5	308	104732
Monoblock With Shield, Without Peg, With Cadmium Yellow Coding Key 	CompactPCI™ J4/J5	308	104733
Monoblock With Shield, Without Peg, With Brilliant Blue Coding Key 	CompactPCI™ J4/J5	308	104734

2.0 mm ERmet Hard Metric Connector System

Vertical Male Monoblock Modules



2.0 mm ERmet

220 signal contacts
94 mm with multifunction block



The ERmet™ vertical male monoblock connector integrates the type A and the type B in one single piece. The monoblock provides a maximum of 308 contacts in 7 rows by 44 positions. The two outer rows, z and f are for the shielding contacts of the female connector. The monoblock has integrated pre-centering and as option integrated coding acc. to PICMG Spec. for 3.3V or 5.0V, which requires 3 positions. The monoblock has been designed especially for CompactPCI applications. Available are versions with standard pin length for the positions P1 and P2 and versions with extended terminals for rear I/O for the positions P4 and P5. The monoblock has a length of 94mm (3U) and can also be used for other applications in 19" rack systems.

Dimensional drawings

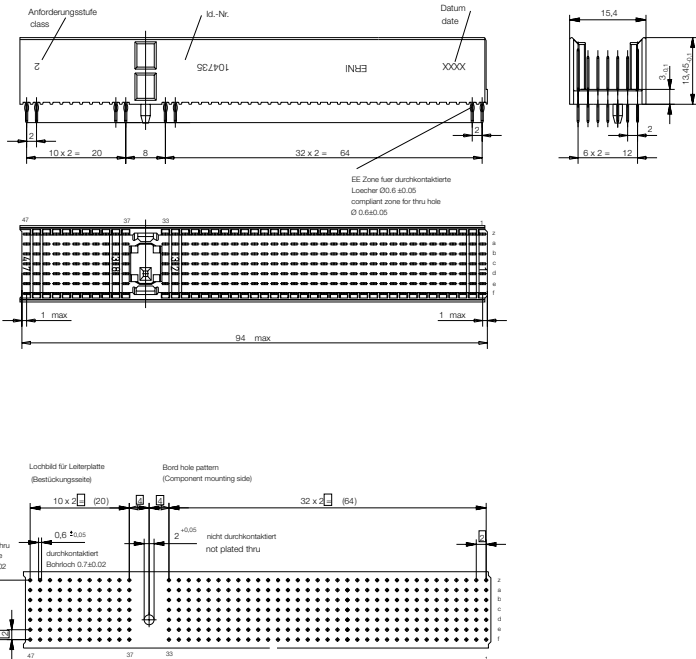





Note: The numbering on the connectors themselves is in accordance with the EC 61076-4-101 standard. All dimensions in mm.

2.0 mm ERmet Hard Metric Connector System

Vertical Male Monoblock Modules



Ordering Information

Configuration	Used For	No. of Pins	Part Number
Monoblock With Peg, With Shield 	CompactPCI™ P1/P2	308	104735
Monoblock With Shield, Without Peg, With Cadmium Yellow Coding Key 	CompactPCI™ P1/P2	308	104736
Monoblock With Shield, Without Peg, With Brilliant Blue Coding Key 	CompactPCI™ P1/P2	308	104737
Monoblock With Peg, With Shield And With Extended Terminals 	CompactPCI™ P1 Per PICMG 2.0 R 2.1 P2	308	104765
Monoblock With Peg, With Shield And With Extended Terminals 	CompactPCI™ P1 Per PICMG 2.0 R 2.1 P2	308	104766

Contact versions

ERNI can accommodate any pattern of male connector contact loading.

For shield rows z and f (7 row connectors) or z and y (10 row connectors), level 3 contacts should be specified. For rear I/O and shrouds, choose contacts with the R1, R2 or R3 terminal length. Each contact has a unique letter designation. Use this letter designation when filling in the contact loading requirements on the ERNI Customer Request Form.

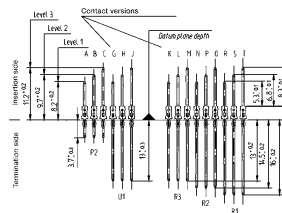

2.0 mm ERmet Hard Metric Connector System

Dust Covers For Type A, B, AB, D, E and DE



2.0 mm ERmet



The dust and protection cover for the male connectors for the ERmet™ 2.0 mm connector system acc. to IEC 61076-4-101 protect the mating area at the frontside of the backplane and what is more important the transfer area on the rearside of the backplane against damage of the contacts. They are also a protection for transportation and against dust. The dust and protection cover is available in two versions for type A, B, AB and for type D, E, DE with or without grip.

Dimensional Drawings

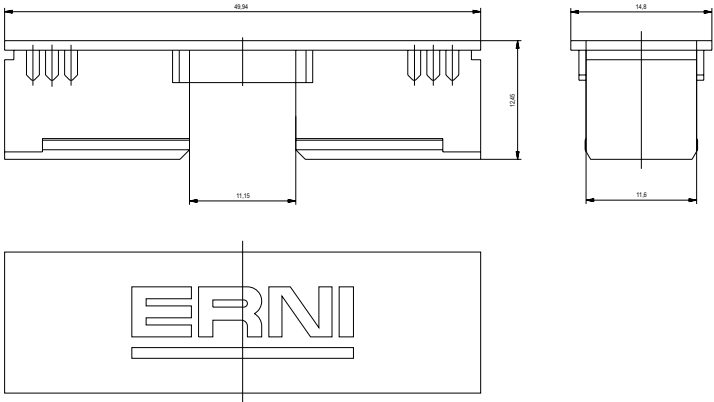

Note: All dimensions in mm

2.0 mm ERmet Hard Metric Connector System

Dust Covers For Type A, B, AB, D, E and DE



Ordering Information

Configuration	Used For	No. of Pins	Part Number
A, B, AB Dust Cover Without Handle For Vacuum Pickup			104070
D, E, DE Dust Cover Without Handle For Vacuum Pickup			104939
A, B, AB Dust Cover With Handle For Hand Placement			114039
D, E, DE Dust Cover With Handle For Hand Placement			114040

2.0 mm ERmet Hard Metric Connector System

Coding Keys



2.0 mm ERmet

Ordering Information

Coding keys for male connectors and shrouds

Coding Key	Code No.	Colour	Part Number
	3568	Pastel Orange RAL 2003 Fincke 00233197	043342
	3478	Steel Blue RAL 5011 Fincke 00251197	043343
	3467	Slate Grey RAL 7015 Fincke 00235197	043344
	3456	Cadmium Yellow RAL 1021 Fincke 00252197	043345
	2578	Reseda Green RAL 6011 Fincke 00237197	043346
	1567	Brilliant Blue RAL 5007 Fincke 00245197	043347
	1356	Blue/Lilac RAL 4005 Fincke 00246197	043348
	4678	Ocher Yellow RAL 1024 Fincke 00313197	043349
	1248	Strawberry Red RAL 3018 Fincke 00312197	043350
	1236	Nut Brown RAL 8011 Fincke 00272197	043351

Coding keys for female connectors

Coding Key	Code No.	Colour	Part Number
	1247	Pastel Orange RAL 2003 Fincke 00233197	043332
	1256	Steel Blue RAL 5011 Fincke 00251197	043333
	1258	Slate Grey RAL 7015 Fincke 00235197	043334
	1278	Cadmium Yellow RAL 1021 Fincke 00252197	043335
	1346	Reseda Green RAL 6011 Fincke 00237197	043336
	2348	Brilliant Blue RAL 5007 Fincke 00245197	043337
	2478	Blue/Lilac RAL 4005 Fincke 00246197	043338
	1235	Ocher Yellow RAL 1024 Fincke 00313197	043339
	3567	Strawberry Red RAL 3018 Fincke 00312197	043340
	4578	Nut Brown RAL 8011 Fincke 00272197	043341
		Mounting Device For Coding-Keys	053593

2.0 mm ERmet Hard Metric Connector System

Guide Pin for ERmet 10 Row Type D



The optional applicable guide pin for the 10 row ERmet type D connector made of stainless steel is suited for the secure pre-centering when mating. The guide pin will be screwed with the connector and the pcb after the male connector has been pressed-in.

Ordering Information

Description	Part Number
Guide Pin	104790
Toothed Lock Washer	104788
Hexagon Nut #2-56 UNC-2A	104789
Kit (Including Guide Pin, Toothed Lock Washer and Hexagon Nut)	104791

2.0 mm ERmet Hard Metric Connector System

Special Contacts for Type L, M and N

ERNI

2.0 mm ERmet



Ordering Information For Coax Contacts

Characteristic Impedance	Contact Version	Cable Type	Part Number
50 Ohm	Male; Crimp-Version	RG 178 B/U; RG 196 A/U	013686
50 Ohm	Female; Crimp-Version	RG 178 B/U; RG 196 A/U	013687
50 Ohm	Male; PCB-Solder-Version; Right Angle		053299
50 Ohm	Female; Crimp-Version	RG 316 Protected	053395
50 Ohm	Male; Crimp-Version	RG 316 Protected	053400
50 Ohm	Female; Crimp-Version	RG 174 /U; RG 188 A/U; RG 316 /U	054238
50 Ohm	Male; Press-Fit-Version; Right Angle		104875
50 Ohm	Female; Crimp-Version	RG 174 /U; RG 188 A/U; RG 316 /U	594207
50 Ohm	Male; Crimp-Version	RG 174 /U; RG 188 A/U; RG 316 /U	594213
50 Ohm	Female; PCB-Solder-Version		914382
75 Ohm	Male; PCB-Solder-Version; Right Angle		053306
75 Ohm	Male; Crimp-Version	RG 179 B/U; RG 187 A/U	053408
75 Ohm	Female; Crimp-Version	RG 179 B/U; RG 187 A/U	053410

Ordering Information for High Power Contacts

Max. Current	Contact Version	Comments	Part Number
10 A	Female; Crimp-Version		594178
20 A	Female; Crimp-Version		594180
30 A	Female; Crimp-Version		053452
40 A	Female; Crimp-Version		594182
40 A	Female; Press-Fit-Version R3		044965
10 A	Female; Solder-Version		594172
20 A	Female; Solder-Version		594174
40 A	Female; Solder-Version		594176
40 A	Female; Solder-Version; Right Angle		053298
10 A	Male; Crimp-Version		594227
20 A	Male; Crimp-Version	First Made Last Break; Only Usable With Part No. 044965	053430
20 A	Male; Crimp-Version		594229
30 A	Male; Crimp-Version		033319
40 A	Male; Crimp-Version		594231
10 A	Male; Press-Fit-Version R1	First Made Last Break	103855
40 A	Male; Press-Fit-Version R1	First Made Last Break; Only Usable With Part No. 044965	044846
40 A	Male; Press-Fit-Version R1		044847
10 A	Male; Solder- Version		594221
20 A	Male; Solder- Version		594223
40 A	Male; Solder- Version		594225
10 A	Male; Solder-Version	First Made Last Break; Only Usable With Part No. 044965	053444



Modular press-fit tools for male and female connectors

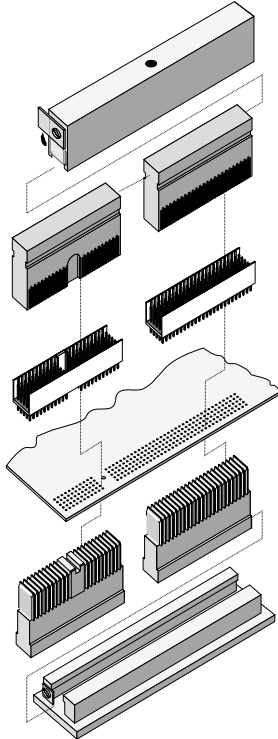

Modular press-fit tool male connector modules 5+2

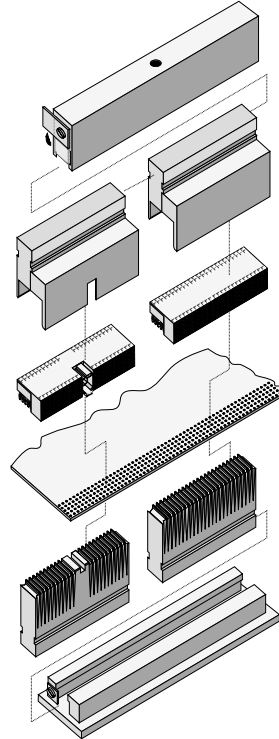

Modular press-fit tool for female connector modules 5+2

ERmet connectors can be end to end mounted in modular layout. To be able to press-fit the selected connector layout for your application in a rationalized way, we have designed the necessary press-fit tools to be modular too. This is true of the tools both for male connectors and for female connectors. The tool bases, also termed anvils, are fixed in a tool holder. Each connector module requires an appropriately sized tool module.

The standard tool holders are designed for two 50 mm modules (modules A, B, L and M), press-fitting a total module length of 100 mm. Due to the modular tool configuration, press-fitting can be carried out in any order. Using filler elements, it is also possible to press-fit just individual modules.

For details on how to order press-fit tools, please contact the factory.



Press-In-Tools For The Female Connectors

Ordering Information

Design	Module	Upper Tools	Lower Tools	Comments
Female	A	220006	220020	Standard
Female	B/AB	220006	220021	Standard
Female	C	220007	220022	Standard
Female	L	220008	220023	Standard; High Power Contact, Press-fit
Female	L	220008	220402	Standard; Coax-Contact, Press-fit
Female	M	220009	220024	Standard; High Power Contact, Press-fit
Female	M	220009	220323	Standard; Coax-Contact, Press-fit
Female	M	220009	220415	Standard; Coax-Contact, Solder
Female	N	220010	220025	Standard; High Power Contact, Press-fit
Female	N	220010	220287	Standard; Coax-Contact, Press-fit
Female	A	220093	220020	Upper Shield
Female	B/AB	220093	220021	Upper Shield
Female	C	220096	220022	Upper Shield
Female	M	220322	220024	Upper Shield ; High Power Contact, Press-fit
Female	M	220322	220323	Upper Shield ; Coax- Contact, Press-fit
Female	A	220436	220437	Lower Shield
Female	A/AB	220436	220437	Lower Shield
Female	C	220453	220454	Lower Shield
Female	D	220253	220250	Standard
Female	E/DE	220253	220251	Standard
Female	F	220254	220252	Standard
Female	D	220256	220250	Upper Shield
Female	E/DE	220256	220251	Upper Shield
Female	F	220257	220252	Upper Shield
Female	D	220455	220458	Lower Shield
Female	E/DE	220455	220456	Lower Shield
Female	F	220457	220458	Lower Shield
Female	B19/AB19	220175	220176	VME/64
Female	B19/AB19	220179	220176	VME/64 Upper Shield
Female	B19/AB19	220449	220450	VME/64 Lower Shield
Female	B22/AB22	220183	220184	PCI
Female	B22/AB22	220187	220184	PCI Upper Shield
Female	B22/AB22	220451	220452	PCI Lower Shields
Vertical Fem.	A	220204	220026	Standard
Vertical Fem.	B	220204	220027	Standard
Vertical Fem.	B19	220356	220174	VME/64
Vertical Fem.	B22	220357	220182	PCI
Vertical Fem.	C	220341	220028	Standard
Vertical Fem.	D	220477	220247	Standard
Vertical Fem.	E	220477	220248	Standard
Vertical Fem.	F	220478	220249	Standard



Press-In-Tools For The Male Connectors

Ordering Information

Design	Module	Upper Tools	Lower Tool	Comment
Male	A	220011	220026	Standard
Male	A	220469	220026	Standard; Integrated Coding
Male	B	220012	220027	Standard
Male	AB25	220376	220027	Standard
Male	AB22	220401	220182	Standard
Male	AB19	220400	220174	Standard
Male	C	220013	220028	Standard
Male	L	220014	220029	Standard; High Power Contact, Press-fit
Male	L	220420	220421	Standard; Coax-Contact, Press-fit
Male	M	220015	220030	Standard; High Power Contact, Press-fit
Male	M	220422	220423	Standard; Coax-Contact, Press-fit
Male	N	220016	220031	Standard; High Power Contact, Press-fit
Male	N	220424	220425	Standard; Coax-Contact, Press-fit
Male	B19	220173	220174	VME/64
Male	B22	220181	220182	PCI
Male	D	220244	220247	Standard
Male	E	220245	220248	Standard
Male	F	220246	220249	Standard
Male	DE	220410	220248	Standard

Toolholder

Ordering Information

Description	Part Number	Length	Comment
Holder Upper Tool	220001	100mm long	with mounting pivot Ø 20
Holder Upper Tool	220002	100 mm long	with quick change
Holder Upper Tool	220188	150 mm long	with mounting pivot Ø 20
Holder Upper Tool	220003	150 mm long	with quick change
Holder Upper Tool	220004	250 mm long	with mounting pivot Ø20
Holder Upper Tool	220005	250 mm long	with quick change
Holder Lower Tool	220191	100 mm long	for lowerable table
Holder Lower Tool	220267	150 mm long	for lowerable table
Holder Lower Tool	220268	250 mm long	for lowerable table

2.0 mm ERmet Hard Metric Connector System

3U CompactPCI® Daughter Card Layout



The 3U CompactPCI® backplane and daughter card layouts are provided to clarify the contact numbering and connector nomenclature used within the specification. As is typical of some telecommunication applications, the CompactPCI® specification numbers the signals and

connectors from the bottom up. Manufacturers and users should note that the connectors themselves are labeled in accordance to IEC 61076-4-101 and prevailing industry practice from the top down.

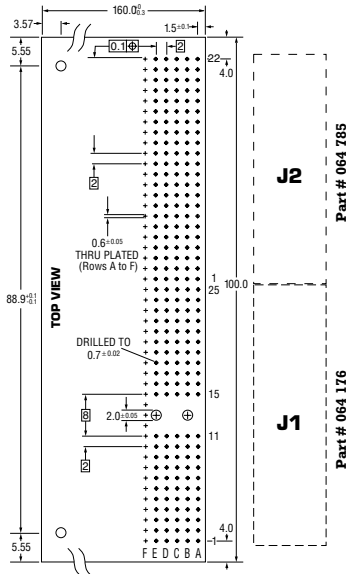

Note that the backplane and daughter card are numbered in accordance with the CompactPCI® specification. The numbering on the connectors themselves is different and in accordance with the IEC 61076-4-101 standard. All dimensions are in millimeters (mm) unless otherwise noted.

2.0 mm ERmet Hard Metric Connector System

3U CompactPCI® Backplane Layout



The 3U CompactPCI® backplane layout is provided to clarify the contact numbering and connector nomenclature used within the specification. As is typical of some telecommunication applications, the CompactPCI® specification numbers the signals and con-

nectors from the bottom up. Manufacturers and users should note that the connectors themselves are labeled in accordance to IEC 61076-4-101 and prevailing industry practice from the top down.

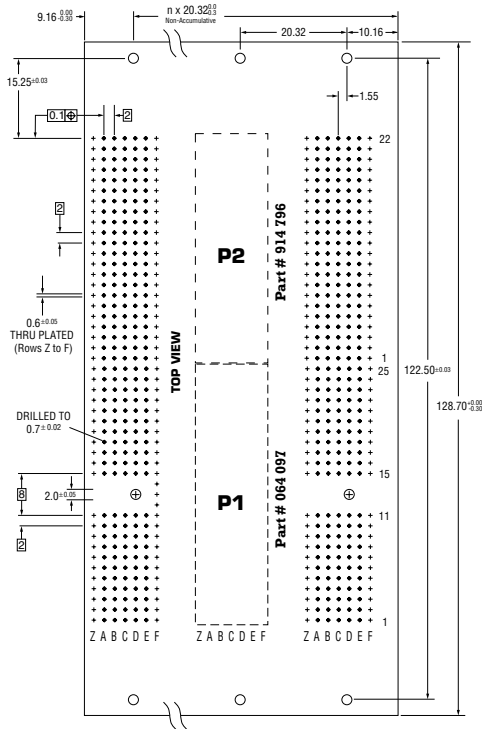

Note that the backplane is numbered in accordance with the CompactPCI® specification. The numbering on the connectors themselves is different and in accordance with the IEC 61076-4-101 standard. All dimensions are in millimeters (mm) unless otherwise noted.

2.0 mm ERmet Hard Metric Connector System

6U CompactPCI® Daughter Card Layout



2.0 mm ERmet

The 6U CompactPCI® backplane layout is provided to clarify the contact numbering and connector nomenclature used within the specification.

As is typical of some telecommunication applications, the CompactPCI® specification numbers the signals and connectors from the bottom up. Manufacturers and users should note that the connectors themselves are labeled in accordance to IEC 61076-4-101 and prevailing industry

practice from the top down.

In many applications, the J3, J4 and J5 connectors are used for user I/O. The J3 connector matches the VME64 extensions P0 connector exactly and falls symmetrically on the centerline of the daughter card. Designers should note that this connector is not on the same grid as the J1, J2, J4 and J5 connectors.

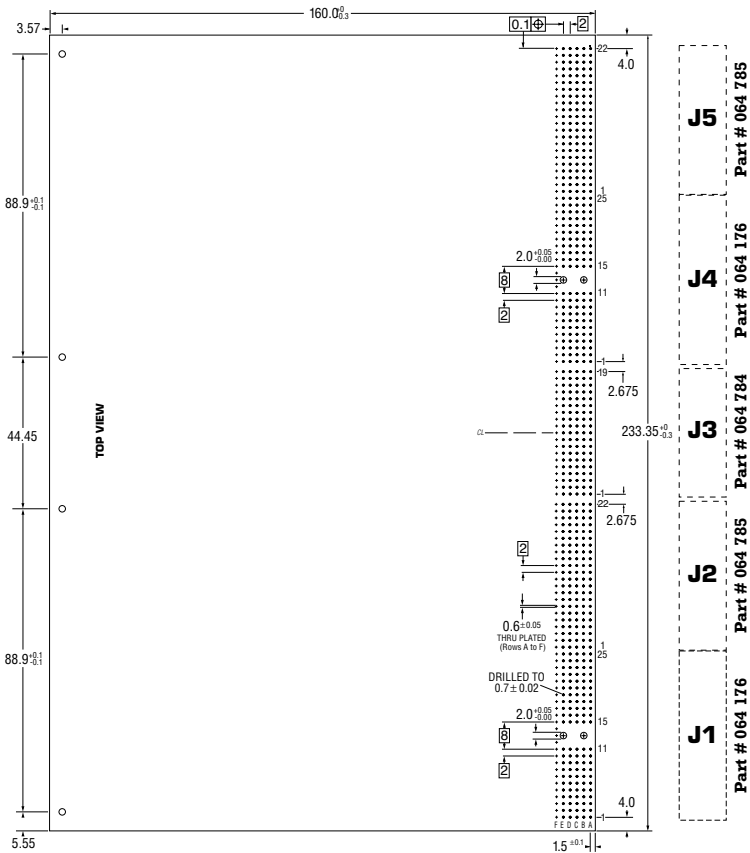

Note that the daughter card is numbered in accordance with the CompactPCI® specification. The numbering on the connectors themselves is different and in accordance with the IEC 61076-4-101 standard.

All dimensions are in millimeters (mm) unless otherwise noted.

2.0 mm ERmet Hard Metric Connector System

6U CompactPCI® Backplane Layout



The 6U CompactPCI® backplane layout is provided to clarify the contact numbering and connector nomenclature used within the specification.

As is typical of some telecommunication applications, the CompactPCI® specification numbers the signals and connectors from the bottom up. Manufacturers and users should note that the connectors themselves are labeled in accordance to IEC 61076-4-101 and prevailing industry practice from the top down.

In many applications, the P3, P4 and P5 connectors are designed for user I/O. Therefore connectors with 16 mm rear tails are used with shrouds installed on the rear side. The P3 connector matches the VME64 extensions J0 connector exactly, and falls symmetrically on the centerline of the backplane. Designers should note that this connector is not on the same grid as the P1, P2, P4 and P5 connectors.

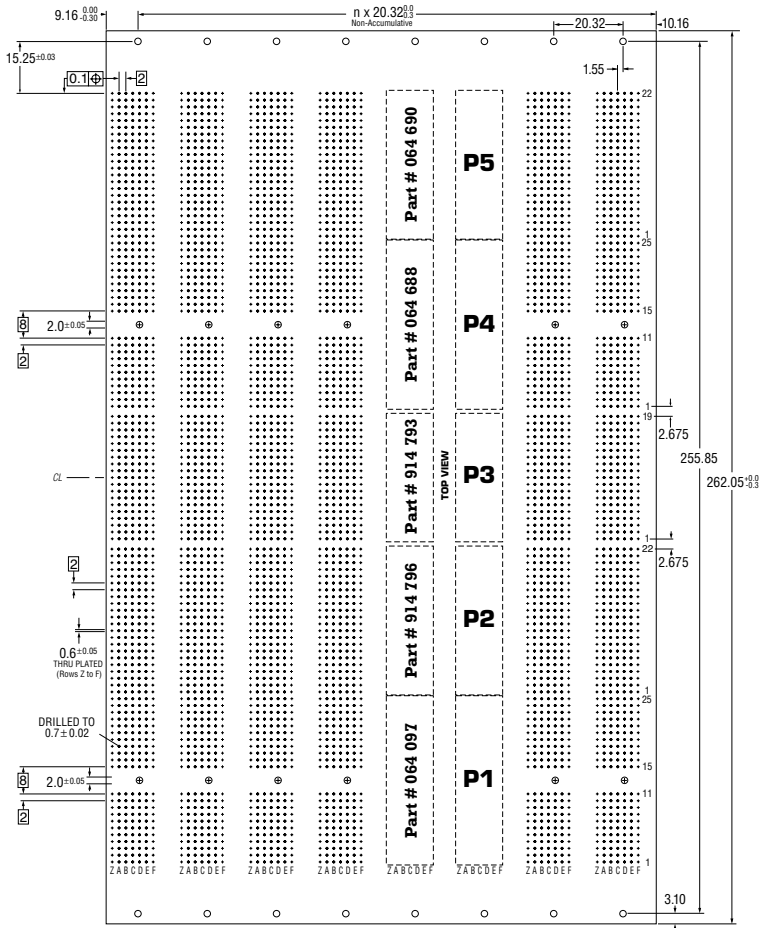

Note that the backplane is numbered in accordance with the CompactPCI® specification. The numbering on the connectors themselves is different and in accordance with the IEC 61076-4-101 standard.

All dimensions are in millimeters (mm) unless otherwise noted.

2.0 mm ERmet Hard Metric Connector System

9U 10-Row 2mm Daughter Card Layout



This 9U eurocard compatible daughtercard layout is provided for designers who need over 1400 signal pins in a eurocard format. This is one of the highest I/O densities

that is currently available in a eurocard format. This design is to be used with the ERmet 8+2 row connectors.

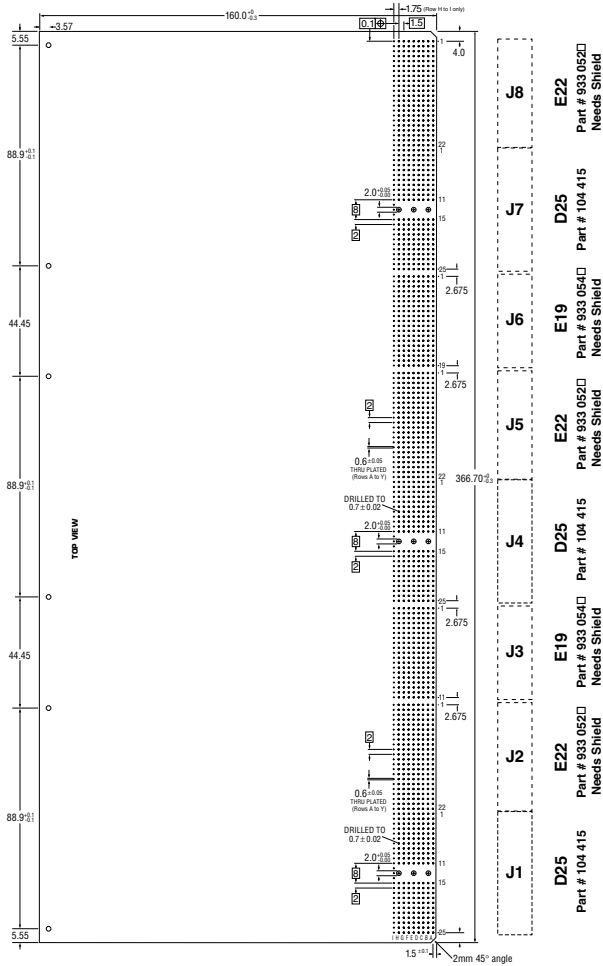

Note that the numbering scheme conforms with the Type V numbering as defined in VITA30-199x Draft 0.5 dated 9 June 1999 and is from the top down. This numbering scheme is identical to the numbering established for the connector within the IEC 61076-4-101 standard.

2.0 mm ERmet Hard Metric Connector System

9U 10-Row 2mm Backplane Layout



This 9U eurocard compatible backplane layout is provided for designers who need over 1400 signal pins in a eurocard format. This is one of the highest I/O densities that is currently available in a eurocard format. This design is to be

used with the ERmet 8+2 row connectors. Note that the backplane connectors have a 5HP or 25.4 mm slot to slot spacing.

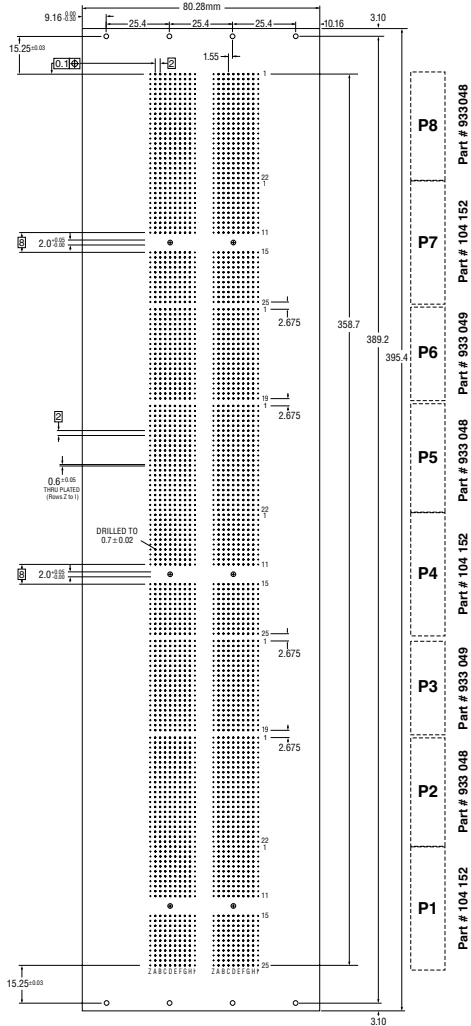

Note that the numbering scheme conforms with the Type V numbering as defined in VITA30-199x Draft 0.5 dated 9 June 1999 and is from the top down. This numbering scheme is identical to the numbering established for the connector within the IEC 61076-4-101 standard.

2.0 mm ERmet Hard Metric Connector System

IEEE 1301 Daughter Cards for IEC 61076-4-101 2mm HM Connectors



The 2mm HM Connector was originally developed to be used within subrack and backplanes designed in accordance with IEEE 1301 Standard for Metric Equipment Practices for Microcomputers. This was a standard that was popular with the large telecommunication companies. Although IEEE 1301 never became as popular as the IEEE

1101 line of Eurocard Packaging, engineers still may occasionally need to layout daughter cards and backplanes to this standard. Note that this layout is drawn to show both the connector grid for 5+2 row connectors and 8+2 row connectors.

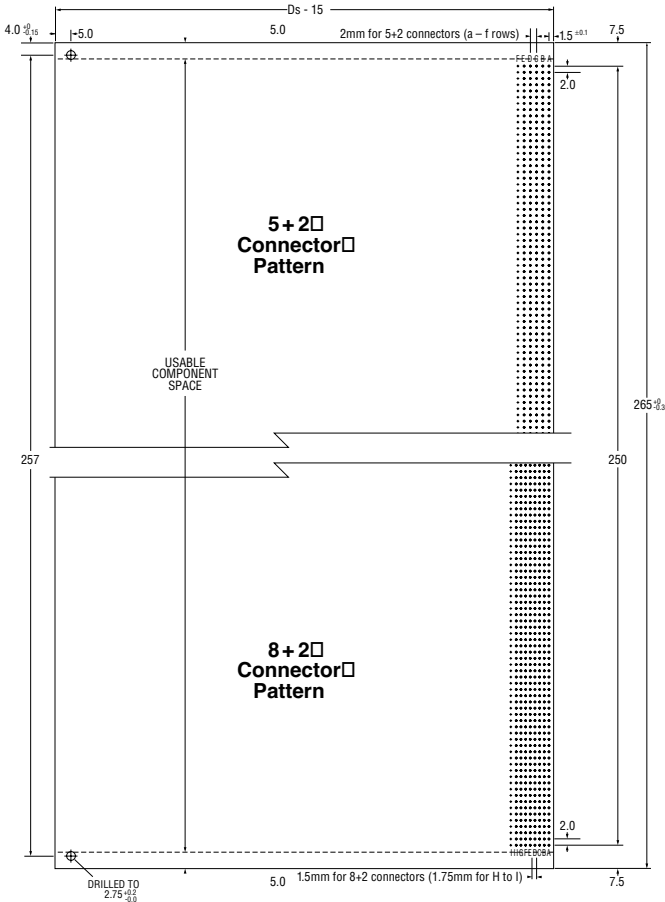

2.0 mm ERmet Hard Metric Connector System

IEEE 1301 Backplane Layouts For IEC 61076-4-101 2mm HM Connectors



The 2mm HM Connector was originally developed to be used within subrack and backplanes designed in accordance with IEEE 1301 Standard for Metric Equipment Practices for Microcomputers. This was a standard that was popular with the large telecommunication companies. Although IEEE 1301 never became as popular as the IEEE

1101 line of Eurocard Packaging, engineers still may occasionally need to layout daughter cards and backplanes to this standard. Note that this layout is drawn to show both the connector grid for 8+2 connectors and 5+2 row connectors. Although this standard defines multiple heights, this drawing is for the popular 12 SU height.

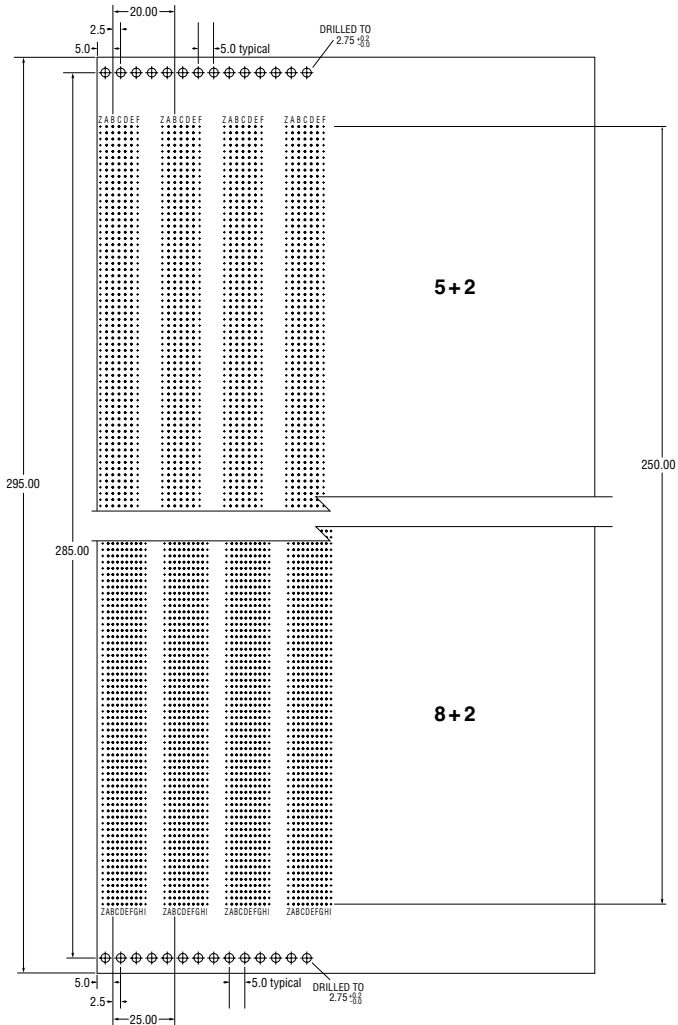

2.0 mm ERmet Hard Metric Connector System

VME64 Extensions Daughter Card



2.0 mm ERmet

The 6U VME64 Extensions document, IEEE 1101.10 defines the daughter card locations for a 2mm HM P0 connector.

This connector is the same connector defined as the J3 connector defined in the VITA 30 2mm equipment practice and used for CompactPCI daughter cards.

Note that the 2mm HM connector is located symmetrically

in between the upper P1 and lower P2 connectors.

This connector is mounted 1.5 mm from the rear board edge but the 160 pin VME64x connector is mounted 2.76 mm from the rear board edge.

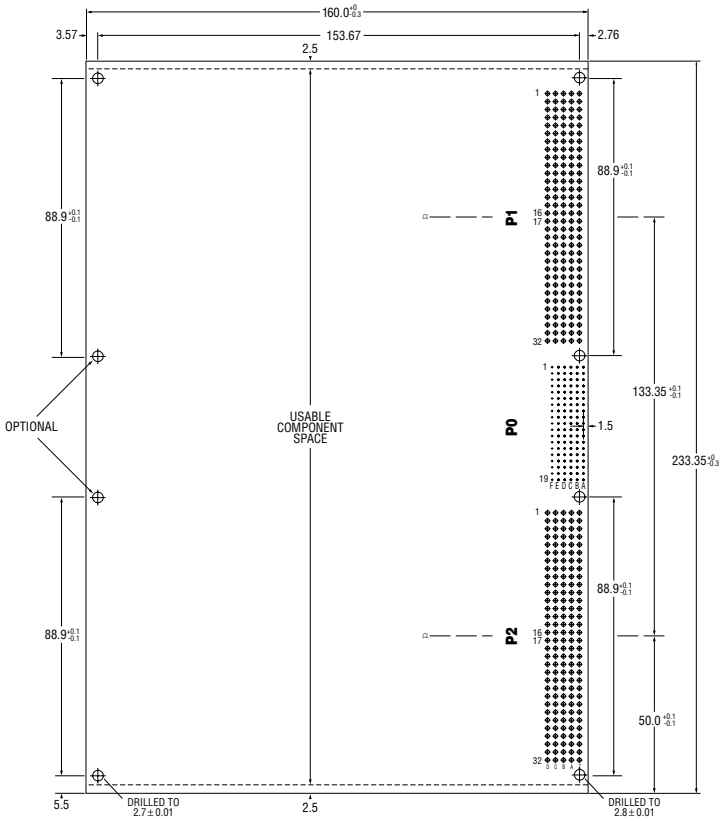

Note that the numbering of the P0 connector conforms to IEEE 1101.1 and 1101.10 and is from the top down. This also is the same numbering scheme established by the connector standard IEC 61076-4-101.

2.0 mm ERmet Hard Metric Connector System

VME64 Extensions Backplane



The 6U VME64 Extensions backplane layout depicts the nomenclature and numbering conventions used in the IEEE 1101.10 draft standard. The J0 center connector is the same 19 position ERmet 2mm H. M. connector used in CompactPCI®. The design of this connector allows it to mate properly with the J1 and J2 connectors which are in accordance with

DIN 41612. Note that there is a 1.85 mm offset between the "C" row of the J0 connector and the "B" row of the 2.54 mm (.100") J1/J2 connectors. On the daughter card, pin 10 of the P0 connector falls exactly on the board's centerline, and pin "A 1" is placed 1.5 mm from the board's edge.

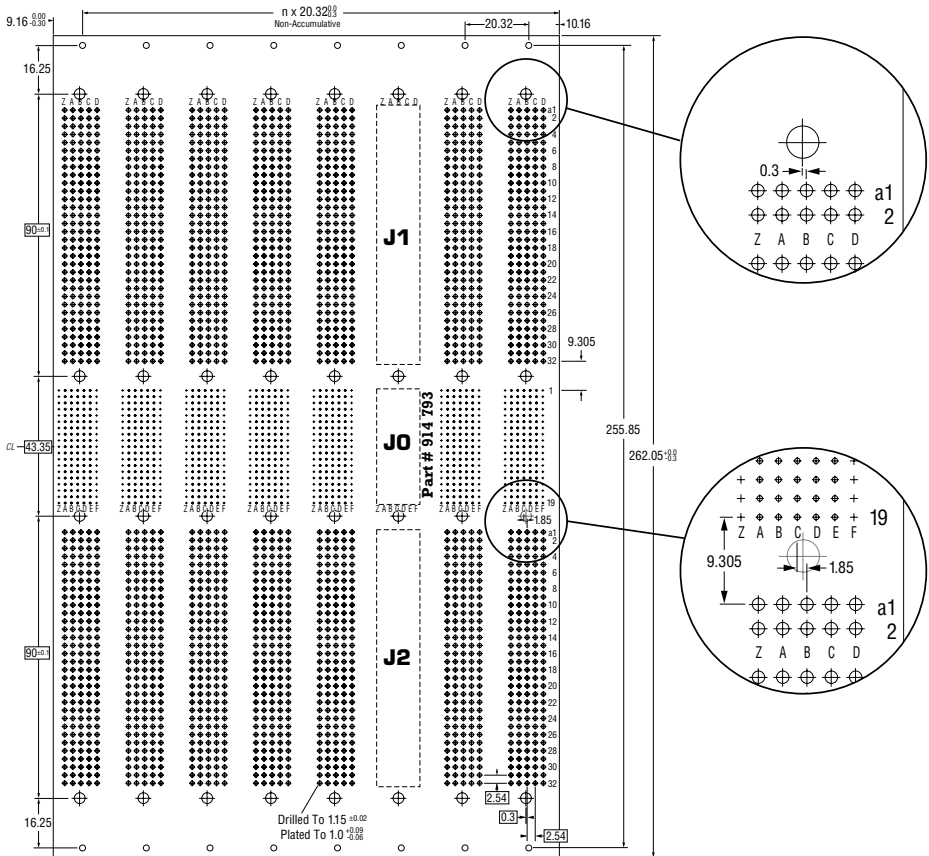

Note that the numbering of the P0 connector conforms to IEEE 1101.1 and 1101.10 and is from the top down. This also is the same numbering scheme established by the connector standard IEC 61076-4-101.

2.0 mm ERmet Hard Metric Connector System

64 Bit CompactPCI® System Slot Pin Assignments



2.0 mm ERmet

In the case of the 64 bit CompactPCI®, both the P1 and P2 connectors are fully assigned with no pins available for user defined I/O. For such systems, only 6U designs can have rear panel I/O.

3U cards, 6U implementations provide optional P3, P4 and P5 connectors, which all have undefined pins for user I/O. 6U CompactPCI® provides more user defined pins than any other bus structure today.

Although CompactPCI® is designed to be accomplished on

PIN	Z ^(m)	A	B	C	D	E	F	
22	GND	GA4 ⁽⁶⁾	GA3 ⁽⁶⁾	GA2 ⁽⁶⁾	GA1 ⁽⁶⁾	GA0 ⁽⁶⁾	GND	P2
21	GND	CLK6	GND	RSV	RSV	RSV	GND	
20	GND	CLK5	GND	RSV	GND	RSV	GND	
19	GND	GND	GND	RSV ⁽⁶⁾	RSV ⁽⁶⁾	RSV ⁽⁶⁾	GND	
18	GND	BRSVP2A18	BRSVP2B18	BRSVP2C18	GND ⁽⁶⁾	BRSVP2E18	GND	
17	GND	BRSVP2A17	GND	PRST#	REQ6#	GNT6#	GND	
16	GND	BRSVP2A16	BRSVP2B16	DEG#	GND	BRSVP2E16	GND	
15	GND	BRSVP2A15	GND	FAL#	REQ5#	GNT5#	GND	
14	GND	AD[35]	AD[34]	AD[33]	GND	AD[32]	GND	
13	GND	AD[38]	GND	V(I/O) ⁽⁵⁾	AD[37]	AD[36]	GND	
12	GND	AD[42]	AD[41]	AD[40]	GND	AD[39]	GND	
11	GND	AD[45]	GND	V(I/O) ⁽⁵⁾	AD[44]	AD[43]	GND	
10	GND	AD[49]	AD[48]	AD[47]	GND	AD[46]	GND	
9	GND	AD[52]	GND	V(I/O) ⁽⁵⁾	AD[51]	AD[50]	GND	
8	GND	AD[56]	AD[55]	AD[54]	GND	AD[53]	GND	
7	GND	AD[59]	GND	V(I/O) ⁽⁵⁾	AD[58]	AD[57]	GND	
6	GND	AD[63]	AD[62]	AD[61]	GND	AD[60]	GND	
5	GND	C/BE[5]#	GND	V(I/O) ⁽⁵⁾	C/BE[4]#	PAR6A	GND	
4	GND	V(I/O) ⁽⁵⁾	BRSVP2B4	C/BE[7]#	GND	C/BE[6]#	GND	
3 ⁽⁸⁾	GND	CLK4	GND	GNT3#	REQ4#	GNT4#	GND	
2 ⁽⁸⁾	GND	CLK2	CLK3	SYSEN# ⁽⁹⁾	GNT2#	REQ3#	GND	
1 ⁽⁸⁾	GND	CLK1	GND	REQ1#	GNT1#	REQ2#	GND	
25	GND	5V	REQ64#	ENUM#	3.3V	5V	GND	P1
24	GND	AD[1]	5V	V(I/O) ⁽⁵⁾⁽¹⁰⁾	AD[0]	ACK64#	GND	
23	GND	3.3V	AD[4]	AD[3]	5V ⁽¹⁰⁾	AD[2]	GND	
22	GND	AD[7]	GND	3.3V ⁽¹⁰⁾	AD[6]	AD[5]	GND	
21	GND	3.3V	AD[9]	AD[8]	M66EN ⁽⁵⁾	C/BE[0]#	GND	
20	GND	AD[12]	GND	V(I/O) ⁽⁵⁾	AD[11]	AD[10]	GND	
19	GND	3.3V	AD[15]	AD[14]	GND ⁽¹⁰⁾	AD[13]	GND	
18	GND	SERR#	GND	3.3V	PAR	C/BE[1]#	GND	
17	GND	3.3V	IPMBSCL	IPMBSDA	GND ⁽¹⁰⁾	PERR#	GND	
16	GND	DEVSEL#	GND	V(I/O) ⁽¹⁰⁾⁽⁵⁾	STOP#	LOCK#	GND	
15	GND	3.3V	FRAME#	IRDY#	GND ⁽¹⁰⁾	TRDY#	GND	
12-14				KEY AREA				
11	GND	AD[18]	AD[17]	AD[16]	GND ⁽¹⁰⁾	C/BE[2]#	GND	
10	GND	AD[21]	GND	3.3V	AD[20]	AD[19]	GND	
9	GND	C/BE[3]#	GND ⁽¹⁰⁾	AD[23]	GND ⁽¹⁰⁾	AD[22]	GND	
8	GND	AD[26]	GND	V(I/O) ⁽⁵⁾	AD[25]	AD[24]	GND	
7	GND	AD[30]	AD[29]	AD[28]	GND ⁽¹⁰⁾	AD[27]	GND	
6	GND	REQ0#	GND	3.3V ⁽¹⁰⁾	CLK0	AD[31]	GND	
5	GND	BRSVP1A5	BRSVP1B5	RST#	GND ⁽¹⁰⁾	GNT0#	GND	
4	GND	IPMB PWR	HEALTHY# ⁽⁷⁾	V(I/O) ⁽⁵⁾⁽¹⁰⁾	INTP	INTS	GND	
3	GND	INTA#	INTB#	INTC#	5V ⁽¹⁰⁾	INTD#	GND	
2	GND	TCK ⁽⁶⁾	5V	TMS ⁽⁶⁾	TDO ⁽⁶⁾	TDI ⁽⁶⁾	GND	
1	GND	5V	-12V	TRST# ⁽⁶⁾	+12V	5V	GND	
PIN	Z ^(m)	A	B	C	D	E	F	

Per CompactPCI® Specification 2.0 R3.0, October 1, 1999, Tabelle 15

- (1) Early mate pins.
- (2) Late mate pins.
- (3) 3.3 V or 5.0 V.
- (4) Grounded in system slot.
- (5) Ground for a 33 MHz backplane. Bussed slot to slot in 66 MHz systems.
- (6) Each slot may have a unique geographic address encoding. See the CompactPCI® specification for details.
- (7) Backplane must leave pin open and provide # bypass capacitor.
- (8) JTAG is being discouraged. These pins will be redefined.
- (9) To be used for I²C bus.
- (10) Daughtercards do not make use of "z" row grounds.

Note: Chart numbering conforms to the CompactPCI® specification. Connector numbering is from top to bottom in accordance with the IEC standard.

2.0 mm ERmet Hard Metric Connector System

64 Bit CompactPCI® Peripheral Slot Pin Assignments



In the case of the 64 bit CompactPCI®, both the P1 and P2 connectors are fully assigned with no pins available for user defined I/O. For such systems, only 6U designs can have rear panel I/O. Although CompactPCI® is designed to be accomplished

on 3U cards, 6U implementations provide optional P3, P4 and P5 connectors, which all have undefined pins for user I/O. 6U CompactPCI® provides more user defined pins than any other bus structure today.

PIN	Z ^(m)	A	B	C	D	E	F		
22	GND	GA4 ⁽⁶⁾	GA3 ⁽⁶⁾	GA2 ⁽⁶⁾	GA1 ⁽⁶⁾	GA0 ⁽⁶⁾	GND	P2	
21	GND	RSV	RSV	RSV	RSV	RSV	GND		
20	GND	RSV	RSV	RSV	GND	RSV	GND		
19	GND	RSV	RSV	RSV	RSV	RSV	GND		
18	GND	BRSVP2A18	BRSVP2B18	BRSVP2C18	GND	BRSVP2E18	GND		
17	GND	BRSVP2A17	GND	RSV	RSV	RSV	GND		
16	GND	BRSVP2A16	BRSVP2B16	RSV	GND ⁽⁹⁾	BRSVP2E16	GND		
15	GND	BRSVP2A15	GND	RSV	RSV	RSV	GND		
14	GND	AD[35]	AD[34]	AD[33]	GND	AD[32]	GND		C O N N E C T O R
13	GND	AD[38]	GND	V(I/O) ⁽³⁾	AD[37]	AD[36]	GND		
12	GND	AD[42]	AD[41]	AD[40]	GND	AD[39]	GND		
11	GND	AD[45]	GND	V(I/O) ⁽³⁾	AD[44]	AD[43]	GND		
10	GND	AD[49]	AD[48]	AD[47]	GND	AD[46]	GND		
9	GND	AD[52]	GND	V(I/O) ⁽³⁾	AD[51]	AD[50]	GND		
8	GND	AD[56]	AD[55]	AD[54]	GND	AD[53]	GND		
7	GND	AD[59]	GND	V(I/O) ⁽³⁾	AD[58]	AD[57]	GND		
6	GND	AD[63]	AD[62]	AD[61]	GND	AD[60]	GND		
5	GND	C/BE[5]#	GND	V(I/O) ⁽³⁾	C/BE[4]#	PAR64	GND		
4	GND	V(I/O) ⁽³⁾	BRSVP2B4	C/BE[7]#	GND	C/BE[6]#	GND		
3 ⁽⁵⁾	GND	RSV	GND	RSV	RSV	RSV	GND		
2 ⁽³⁾	GND	RSV	RSV	UNC ⁽⁴⁾	RSV	RSV	GND		
1 ⁽³⁾	GND	RSV	GND	RSV	RSV	RSV	GND		
25	GND	5V	REQ64#	ENUM#	3.3V	5V	GND	P1	
24	GND	AD[1]	5V	V(I/O) ⁽³⁾⁽¹⁾	AD[0]	ACK64#	GND		
23	GND	3.3V	AD[4]	AD[3]	5V ⁽¹⁾	AD[2]	GND		
22	GND	AD[7]	GND	3.3V ⁽¹⁾	AD[6]	AD[5]	GND		
21	GND	3.3V	AD[9]	AD[8]	M66EN ⁽¹⁰⁾	C/BE[0]#	GND		
20	GND	AD[12]	GND	V(I/O) ⁽³⁾	AD[11]	AD[10]	GND		
19	GND	3.3V	AD[15]	AD[14]	GND ⁽¹⁾	AD[13]	GND		
18	GND	SERR#	GND	3.3V	PAR	C/BE[1]#	GND		
17	GND	3.3V	IPMBSCL	IPMBSDA	GND ⁽¹⁾	PERR#	GND		
16	GND	DEVSEL#	GND	V(I/O) ⁽³⁾	STOP#	LOCK#	GND		
15	GND	3.3V	FRAME#	IRDY#	BD SEL# ⁽²⁾	TRDY#	GND		
12-14				KEY AREA					
11	GND	AD[18]	AD[17]		AD[16]	GND ⁽¹⁾	C/BE[2]#		GND
10	GND	AD[21]	GND		3.3V	AD[20]	AD[19]		GND
9	GND	C/BE[3]#	IDSEL ⁽²⁾		AD[23]	GND ⁽¹⁾	AD[22]		GND
8	GND	AD[26]	GND		V(I/O) ⁽³⁾	AD[25]	AD[24]	GND	
7	GND	AD[30]	AD[29]		AD[28]	GND ⁽¹⁾	AD[27]	GND	
6	GND	REQ#	GND		3.3V ⁽¹⁾	CLK	AD[31]	GND	
5	GND	BRSVP1A5	BRSVP1B5		RST#	GND ⁽¹⁾	GNT#	GND	
4	GND	IPMB PWR	HEALTHY ⁽⁷⁾		V(I/O) ⁽³⁾⁽¹⁾	INTP	INTS	GND	
3	GND	INTA#	INTB#		INTC#	5V ⁽¹⁾	INTD#	GND	
2	GND	TCK ⁽⁸⁾	5V		TMS ⁽⁸⁾	TDO ⁽⁸⁾	TDI ⁽⁸⁾	GND	
1	GND	5V	-12V		TRST# ⁽⁹⁾	+12V	5V	GND	
PIN	Z ^(m)	A	B	C	D	E	F		

Per CompactPCI® Specification 2.0 R3.0, October 1, 1999, Tabelle 13

- (1) Early mate pins.
- (2) Late mate pins.
- (3) 3.3 V or 5.0 V.
- (4) Grounded in system slot.
- (5) Ground for a 33 MHz backplane. Bussed slot to slot in 66 MHz systems.
- (6) Each slot may have a unique geographic address encoding. See the CompactPCI® specification for details.
- (7) Backplane must leave pin open and provide # bypass capacitor.
- (8) JTAG is being discouraged. These pins will be redefined.
- (9) To be used for I²C bus.
- (10) Daughtercards do not make use of "z" row grounds.

Note: Chart numbering conforms to the CompactPCI® specification. Connector numbering is from top to bottom in accordance with the IEC standard.

2.0 mm ERmet Hard Metric Connector System

32 Bit CompactPCI® System Slot Pin Assignments



2.0 mm ERmet

The CompactPCI® specification defines a 32 bit implementation. The 32 bit implementation makes the entire P2/J2 connector (upper) available for user defined I/O for slots 2-8. The controller card slot (usually slot 1) makes use of some P2 pins for such functions as clock, arbitration,

grant/requests and some other system functions.

In many 32 bit systems, the backplane connector in the P2 position will have 16 mm rear tails and a shroud so I/O signals may pass through the backplane to rear mounted cards or cable assemblies.

PIN	Z ⁽¹⁾	A	B	C	D	E	F	
22	GND	GA4 ⁽²⁾	GA3 ⁽²⁾	GA2 ⁽²⁾	GA1 ⁽²⁾	GA0 ⁽²⁾	GND	P2
21	GND	CLK6#	GND	BP(I/O)	BP(I/O)	BP(I/O)	GND	
20	GND	CLK5#	GND	BP(I/O)	BP(I/O)	BP(I/O)	GND	
19	GND	GND	GND	BP(I/O) ⁽³⁾	BP(I/O) ⁽³⁾	BP(I/O) ⁽³⁾	GND	
18	GND	BP(I/O)	BP(I/O)	BP(I/O)	BP(I/O)	BP(I/O)	GND	
17	GND	BP(I/O)	BP(I/O)	PRST#	REQ6#	GNT6#	GND	
16	GND	BP(I/O)	BP(I/O)	DEG#	GND	BP(I/O)	GND	
15	GND	BP(I/O)	BP(I/O)	FAL#	REQ5#	GNT5#	GND	
14	GND	BP(I/O)	BP(I/O)	BP(I/O)	BP(I/O)	BP(I/O)	GND	
13	GND	BP(I/O)	BP(I/O)	BP(I/O)	BP(I/O)	BP(I/O)	GND	
12	GND	BP(I/O)	BP(I/O)	BP(I/O)	BP(I/O)	BP(I/O)	GND	
11	GND	BP(I/O)	BP(I/O)	BP(I/O)	BP(I/O)	BP(I/O)	GND	
10	GND	BP(I/O)	BP(I/O)	BP(I/O)	BP(I/O)	BP(I/O)	GND	
9	GND	BP(I/O)	BP(I/O)	BP(I/O)	BP(I/O)	BP(I/O)	GND	
8	GND	BP(I/O)	BP(I/O)	BP(I/O)	BP(I/O)	BP(I/O)	GND	
7	GND	BP(I/O)	BP(I/O)	BP(I/O)	BP(I/O)	BP(I/O)	GND	
6	GND	BP(I/O)	BP(I/O)	BP(I/O)	BP(I/O)	BP(I/O)	GND	
5	GND	BP(I/O)	BP(I/O)	BP(I/O)	BP(I/O)	BP(I/O)	GND	
4	GND	V(I/O)	BP(I/O)	BP(I/O)	BP(I/O)	BP(I/O)	GND	
3	GND	CLK4	GND	GNT3#	REQ4#	GNT4#	GND	
2	GND	CLK2	CLK3	SYSEN# ⁽¹⁰⁾	GNT2#	REQ3#	GND	
1	GND	CLK1	GND	REQ1#	GNT1#	REQ2#	GND	
25	GND	5V	REQ64#	ENUM#	3.3V	5V	GND	P1
24	GND	AD[1]	5V	V(I/O) ⁽¹¹⁾	AD[0]	ACK64#	GND	
23	GND	3.3V	AD[4]	AD[3]	5V ⁽¹⁾	AD[2]	GND	
22	GND	AD[7]	GND	3.3V ⁽¹⁾	AD[6]	AD[5]	GND	
21	GND	3.3V	AD[9]	AD[8]	M66EN ⁽⁴⁾	C/BE[0]#	GND	
20	GND	AD[12]	GND	V(I/O) ⁽⁵⁾	AD[11]	AD[10]	GND	
19	GND	3.3V	AD[15]	AD[14]	GND ⁽¹⁾	AD[13]	GND	
18	GND	SERR#	GND	3.3V	PAR	C/BE[1]#	GND	
17	GND	3.3V	IPMB SCL	IPMB SDA	GND ⁽¹⁾	PERR#	GND	
16	GND	DEVSEL	GND	V(I/O) ^{(11),(5)}	STOP#	LOCK#	GND	
15	GND	3.3V	FRAME#	IRDY	GND ⁽²⁾	TRDY#	GND	
12-14				KEY AREA				
11	GND	AD[18]	AD[17]	AD[16]	GND ⁽¹⁾	C/BE[2]#	GND	
10	GND	AD[21]	GND	3.3V	AD[20]	AD[19]	GND	
9	GND	C/BE[3]#	GND ⁽²⁾	AD[23]	GND ⁽¹⁾	AD[22]	GND	
8	GND	AD[26]	GND	V(I/O) ⁽⁵⁾	AD[25]	AD[24]	GND	
7	GND	AD[30]	AD[29]	AD[28]	GND ⁽¹⁾	AD[27]	GND	
6	GND	REQ0#	GND	3.3V ⁽¹⁾	CLK	AD[31]	GND	
5	GND	BRSVP1A5	BRSVP1B5	RST#	GND ⁽¹⁾	GNT0#	GND	
4	GND	IPMB PWR	HEALTHY# ⁽⁷⁾	V(I/O) ^{(11),(1)}	INTP	INTS	GND	
3	GND	INTA#	INTB#	INTC#	5V ⁽¹⁾	INTD#	GND	
2	GND	TCK ⁽⁸⁾	5V	TMS ⁽⁸⁾	TDO ⁽⁸⁾	TDI ⁽⁸⁾	GND	
1	GND	5V	-12V	TRST# ⁽⁸⁾	+12V	5V	GND	
PIN	Z⁽¹⁾	A	B	C	D	E	F	C O N N E C T O R

Per CompactPCI® Specification 2.0 R3.0, October 1, 1999, Tabelle 16

- (1) Early mate pins.
- (2) Late mate pins.
- (3) 3.3 V or 5.0 V.
- (4) Grounded in 33 MHz backplane. Bussed slot to slot in 66 MHz systems
- (5) Each slot may have a unique geographic address encoding. See the CompactPCI® specification for details.
- (6) Daughter cards do not make use of the "Z" row grounds.
- (7) Backplane must leave pin open and provide # bypass capacitor.
- (8) JTAG is being discouraged. These pins will be redefined.
- (9) To be used for I²C bus.
- (10) Grounded in system slot.

Notes: All P2 terminals should be 16 mm long with shroud installed unless they are used for a secondary bus.

Chart numbering conforms to the CompactPCI® specification. Connector numbering is from top to bottom in accordance with the IEC standard.

2.0 mm ERmet Hard Metric Connector System

32 Bit CompactPCI® Peripheral Slot Pin Assignments



The CompactPCI® specification defines a 32 bit implementation. The 32 bit implementation makes the entire P2/J2 connector (upper) available for user defined I/O for slots 2-8. The controller card slot (usually slot 1) makes use of some P2 pins for such functions as clock, arbitration,

grant/requests and some other system functions. In many 32 bit systems, the backplane connector in the P2 position will have 16 mm rear tails and a shroud so I/O signals may pass through the backplane to rear mounted cards or cable assemblies.

PIN	Z ⁽¹⁾	A	B	C	D	E	F		
22	GND	GA4 ⁽²⁾	GA3 ⁽²⁾	GA2 ⁽²⁾	GA1 ⁽²⁾	GA0 ⁽²⁾	GND	P2	
21	GND	BP(I/O)	BP(I/O)	BP(I/O)	BP(I/O)	BP(I/O)	GND		
20	GND	BP(I/O)	BP(I/O)	BP(I/O)	BP(I/O)	BP(I/O)	GND		
19	GND	BP(I/O)	BP(I/O)	BP(I/O)	BP(I/O)	BP(I/O)	GND		
18	GND	BP(I/O)	BP(I/O)	BP(I/O)	BP(I/O)	BP(I/O)	GND		
17	GND	BP(I/O)	BP(I/O)	BP(I/O)	BP(I/O)	BP(I/O)	GND		
16	GND	BP(I/O)	BP(I/O)	BP(I/O)	BP(I/O)	BP(I/O)	GND		
15	GND	BP(I/O)	BP(I/O)	BP(I/O)	BP(I/O)	BP(I/O)	GND		
14	GND	BP(I/O)	BP(I/O)	BP(I/O)	BP(I/O)	BP(I/O)	GND		
13	GND	BP(I/O)	BP(I/O)	BP(I/O)	BP(I/O)	BP(I/O)	GND		
12	GND	BP(I/O)	BP(I/O)	BP(I/O)	BP(I/O)	BP(I/O)	GND		
11	GND	BP(I/O)	BP(I/O)	BP(I/O)	BP(I/O)	BP(I/O)	GND		
10	GND	BP(I/O)	BP(I/O)	BP(I/O)	BP(I/O)	BP(I/O)	GND		
9	GND	BP(I/O)	BP(I/O)	BP(I/O)	BP(I/O)	BP(I/O)	GND		
8	GND	BP(I/O)	BP(I/O)	BP(I/O)	BP(I/O)	BP(I/O)	GND		
7	GND	BP(I/O)	BP(I/O)	BP(I/O)	BP(I/O)	BP(I/O)	GND		
6	GND	BP(I/O)	BP(I/O)	BP(I/O)	BP(I/O)	BP(I/O)	GND		
5	GND	BP(I/O)	BP(I/O)	BP(I/O)	BP(I/O)	BP(I/O)	GND		
4	GND	BP(I/O)	BP(I/O)	BP(I/O)	BP(I/O)	BP(I/O)	GND		
3	GND	BP(I/O)	BP(I/O)	BP(I/O)	BP(I/O)	BP(I/O)	GND		
2	GND	BP(I/O)	BP(I/O)	BP(I/O)	BP(I/O)	BP(I/O)	GND		
1	GND	BP(I/O)	BP(I/O)	BP(I/O)	BP(I/O)	BP(I/O)	GND		
KEY AREA									
25	GND	5V	REQ64#	ENUM#	3.3V	5V	GND	P1	
24	GND	AD[1]	5V	V(I/O) ⁽³⁾⁽¹⁾	AD[0]	ACK64#	GND		
23	GND	3.3V	AD[4]	AD[3]	5V ⁽¹⁾	AD[2]	GND		
22	GND	AD[7]	GND	3.3V ⁽¹⁾	AD[6]	AD[5]	GND		
21	GND	3.3V	AD[9]	AD[8]	M66EN ⁽⁴⁾	C/BE[0]#	GND		
20	GND	AD[12]	GND	V(I/O) ⁽³⁾	AD[11]	AD[10]	GND		
19	GND	3.3V	AD[15]	AD[14]	GND ⁽¹⁾	AD[13]	GND		
18	GND	SERR#	GND	3.3V	PAR	C/BE[1]#	GND		
17	GND	3.3V	IPMB SCL	IPMB SDA	GND ⁽¹⁾	PERR#	GND		
16	GND	DEVSEL	GND	V(I/O) ⁽¹⁾⁽⁵⁾	STOP#	LOCK#	GND		
15	GND	3.3V	FRAME#	IRDY	BD SEL# ⁽²⁾	TRDY#	GND		
KEY AREA									
11	GND	AD[18]	AD[17]	AD[16]	GND ⁽¹⁾	C/BE[2]#	GND		
10	GND	AD[21]	GND	3.3V	AD[20]	AD[19]	GND		
9	GND	C/BE[3]#	IDSEL ⁽⁶⁾	AD[23]	GND ⁽¹⁾	AD[22]	GND		
8	GND	AD[26]	GND	V(I/O) ⁽³⁾	AD[25]	AD[24]	GND		
7	GND	AD[30]	AD[29]	AD[28]	GND ⁽¹⁾	AD[27]	GND		
6	GND	REQ#	GND	3.3V ⁽¹⁾	CLK	AD[31]	GND		
5	GND	BRSVP1A5	BRSVP1B5	RST#	GND ⁽¹⁾	GNT#	GND		
4	GND	IPMB PWR	HEALTHY# ⁽⁷⁾	V(I/O) ⁽³⁾⁽¹⁾	INTP	INTS	GND		
3	GND	INTA#	INTB#	INTC#	5V ⁽¹⁾	INTD#	GND		
2	GND	TCK ⁽⁸⁾	5V	TMS ⁽⁸⁾	TDO ⁽⁸⁾	TDI ⁽⁸⁾	GND		
1	GND	5V	-12V	TRST# ⁽⁸⁾	+12V	5V	GND		
PIN	Z ⁽¹⁾	A	B	C	D	E	F		

Per CompactPCI® Specification 2.0 R3.0, October 1, 1999, Tabelle 14

- (1) Early mate pins.
- (2) Late mate pins.
- (3) 3.3 V or 5.0 V.
- (4) Grounded in 33 MHz backplane. Bussed slot to slot in 66 MHz systems
- (5) Each slot may have a unique geographic address encoding. See the CompactPCI® specification for details.
- (6) Daughter cards do not make use of the "Z" row grounds.
- (7) Backplane must leave pin open and provide # bypass capacitor.
- (8) JTAG is being discouraged. These pins will be redefined.

Notes: All P2 terminals should be 16 mm long with shroud installed unless they are used for a secondary bus. Chart numbering conforms to the CompactPCI® specification. Connector numbering is from top to bottom in accordance with the IEC standard.

2.0 mm ERmet Hard Metric Connector System

cPCI Computer Telephony P4 Pin Assignments



Mechanical Specifications - Backplane and Chassis

Pos#	Row Z	Row A	Row B	Row C	Row D	Row E	Row F						
25	NP	SGA4	M	SGA3	M	SGA2	M	SGA1	M	SGA0	M	FG	L
24	NP	GA4	M	GA3	M	GA2	M	GA1	M	GA0	M	FG	L
23	NP	+12V	M	/CT_Reset	M	/CT_EN	S	-12v	M	CT_MC	M	FG	L
22	NP	PFS0#	M	RSVD	M	RSVD	M	RSVD	M	RSVD	M	FG	L
21	NP	-SELbat	L	PFS1#	M	RSVD	M	RSVD	M	SELvatRtn	L	FG	L
20	NP	NP		NP		NP		NP		NP		NP	
19	NP	NP		NP		NP		NP		NP		NP	
18	NP	VRG	M	NP		NP		NP		VRGTN	M	NP	
17	NP	NP		NP		NP		NP		NP		NP	
16	NP	NP		NP		NP		NP		NP		NP	
15	NP	-VBAT	L	NP		NP		NP		VBATRtn	L	NP	
12-14	KEY AREA (keep unobstructed on backplane to ease routing constraints)												
11	NP	CT_D29	M	CT_D30	M	CT_D31	M	V(I/O)	L	/CT_FRAME A	M	GND	L
10	NP	CT_D27	M	+3.3V	M	CT_D28	M	+5V	L	/CT_FRAME B	M	GND	L
9	NP	CT_D24	M	CR_D25	M	CT_D26	M	GND	L	/FR_COMP	M	GND	L
8	NP	CT_D21	M	CT_D22	M	CT_D23	M	+5V	L	CT_C8_A	M	GND	L
7	NP	CT_D19	M	+5V	M	CT_D20	M	GND	L	CT_C8_B	M	GND	L
6	NP	CT_D16	M	CT_C17	M	CT_D18	M	GND	L	CT_NETREF_1	M	GND	L
5	NP	CT_D13	M	CT_D14	M	CT_D15	M	+3.3V	L	CT_NETREF_2	M	GND	L
4	NP	CT_D11	M	+5V	M	CT_D12	M	+3.3V	L	SCLK	M	GND	L
3	NP	CT_D8	M	CT_D9	M	CT_D10	M	GND	L	SCLK-D	M	GND	L
2	NP	CT_D4	M	CT_D5	M	CT_D6	M	CT_D7	M	GND	L	GND	L
1	NP	CT_D0	M	+3.3V	M	CTP_D1	M	CT_D2	M	CT_D3	M	GND	L

Per CompactPCI® Specification PICMG 2.5 R1.0, April 3, 1998, Table 1

Key to P4 Pin Assignments

- CT_name = H.110 TDM bus signals
- +5V = +5V power
- +3.3V = +3.3V power
- GND = LOGIC GROUND
- V(I/O) = I/O cell power
- FG = Frame Ground
- RSVD = reserved for future use
- NP = a pin and pad to Not be Populated
- SELvat = short loop battery
- SELvatRtn = short loop battery return
- Vbat = telecom power distribution bus
- VbatRtn = return bus pin for -Vbat
- SGA0-SGA4 = shelf enumeration bus signals
- GA0-GA4 = slot ID signals; not bussed
- VRG = bus for ringing voltage
- VRGRtn = bus for ringing voltage
- PFS0#-PFS1# = busses for power fail sense
- KEY AREA = area utilized for key
- S = Short (Level 1) front side pins
- M = Medium (Level 2) front side pins
- L = Long (Level 3) front side pins

2.0 mm ERmet Hard Metric Connector System

cPCI Computer Telephony Safety Classifications for J4/P4



Pos#	Row Z	Row A	Row B	Row C	Row D	Row E	Row F
25							
24							
23							
22							
21							
20	NP	NP	NP	NP	NP	NP	NP
19	NP	NP	NP	NP	NP	NP	NP
18	NP	HAZ	IN/C-NP	IN/C-NP	IN/C-NP	HAZ	NP
17	NP	NP	NP	NP	NP	NP	NP
16	NP	NP	NP	NP	NP	NP	NP
15	NP	HAZ	IN/C-NP	IN/C-NP	IN/C-NP	HAZ	NP
14	KEY AREA (keep unobstructed on backplane to ease routing constraints)						
13							
12							
11							
10							
9							
8							
7							
6							
5							
4							

Per CompactPCI® Computer Telephony Specification PICMG 2.5 R1.0, April 3, 1998, Table 11

2.0 mm ERme Hard Metric Connector System

cPCI Computer Telephony P5 Pin Assignments



Pos#	Row Z	Row A	Row B	Row C	Row D	Row E	Row F
22	NP-IN/C	U T1	S T9	S T17	S T25	S IN/C	S GND-IN/C
21	NP-IN/C	U R1	S R9	S R17	S R25	S IN/C	S GND-IN/C
20	NP-IN/C	U T2	S T10	S T18	S T26	S IN/C	S GND-IN/C
19	NP-IN/C	U R2	S R10	S R18	S R26	S IN/C	S GND-IN/C
18	NP-IN/C	U T3	S T11	S T19	S T27	S IN/C	S GND-IN/C
17	NP-IN/C	U R3	S R11	S R19	S R27	S IN/C	S GND-IN/C
16	NP-IN/C	U T4	S T12	S T20	S T28	S IN/C	S GND-IN/C
15	NP-IN/C	U R4	S R12	S R20	S R28	S IN/C	S GND-IN/C
13	NP-IN/C	U R5	S R13	S R21	S R29	S IN/C	S GND-IN/C
12	NP-IN/C	U T6	S T14	S T22	S T30	S IN/C	S GND-IN/C
11	NP-IN/C	U R6	S R14	S R22	S R30	S IN/C	S GND-IN/C
10	NP-IN/C	U T7	S T15	S T23	S T31	S IN/C	S GND-IN/C
9	NP-IN/C	U R7	S R15	S R23	S R31	S IN/C	S GND-IN/C
8	NP-IN/C	U T8	S T16	S T24	S T32	S IN/C	S GND-IN/C
7	NP-IN/C	U R8	S R16	S R24	S R32	S IN/C	S GND-IN/C
6	NP-IN/C	U IN/C	S IN/C	S IN/C	S IN/C	S IN/C	S GND-IN/C
5	NP-IN/C	U IN/C	S IN/C	S IN/C	S IN/C	S IN/C	S GND-IN/C
4	NP-IN/C	U Uo0	M Uo1	M GND_FT	M GND_FT	M GND_FT	M GND-IN/C
3	NP-IN/C	U Ui0	M Ui1	M Uo4	M Uo5	M Uo6	M GND-IN/C
2	NP-IN/C	U Uo2	M Uo3	M Ui4	M Ui5	M Ui6	M GND-IN/C
1	NP-IN/C	U Ui2	M Ui3	M +5V_FT	M +12V_FT	M -12V_FT	M GND-IN/C

Per CompactPCI® Computer Telephony Specification PICMG 2.5 R1.0, April 3, 1998, Table 3

Key to P5 Pin Assignments

- Tn = Tip
- Rn = Ring
- IN/C = No Connect required for safety agency Insulation requirements
- NP = a position required to be Not Populated (i.e., no conductive element present)
- NP-IN/C = a position which may be either Not Populated or Insulation No Connect
- GND-IN/C = a position which may be either LOGIC GROUND or Insulation No Connect
- +nV_FT = positive supply voltage feed-through from CT Front Card
- nV_FT = negative supply voltage feed-through from CT Front Card
- GND_FT = logic ground feed-through from CT Front Card
- Uin = Universal Input - user defined input signal (input to CT Front Card)
- Uon = Universal Output - user defined input signal (output to CT Front Card)
- U = a pin of unspecified length

- S = Short (Level 1) front side pins
- M = Medium (Level 2) front side pins
- L = Long (Level 3) front side pins

2.3.2.1. P5 Telephony I/O Pins

Tn - Tip - short (Level 1) pins for connecting to the nominally positive side of a balanced pair telephony connection

Rn - Ring - short (Level 1) pins for connecting to the nominally negative side of a balanced pair telephony connection

2.0 mm ERmet Hard Metric Connector System

cPCI Computer Telephony Safety Classifications for J5/P5



Pos#	Row Z	Row A	Row B	Row C	Row D	Row E	Row F
22	NP-IN/C					S IN/C	L
21	NP-IN/C					S IN/C	L
20	NP-IN/C					S IN/C	L
19	NP-IN/C					S IN/C	L
18	NP-IN/C					S IN/C	L
17	NP-IN/C					S IN/C	L
16	NP-IN/C					S IN/C	L
15	NP-IN/C					S IN/C	L
14	NP-IN/C					S IN/C	L
13	NP-IN/C					S IN/C	L
12	NP-IN/C					S IN/C	L
11	NP-IN/C					S IN/C	L
10	NP-IN/C					S IN/C	L
9	NP-IN/C					S IN/C	L
8	NP-IN/C					S IN/C	L
7	NP-IN/C					S IN/C	L
6	NP-IN/C	IN/C		IN/C		IN/C	L
5	NP-IN/C	IN/C		IN/C		IN/C	L
4	NP-IN/C						L
3	NP-IN/C						L
2	NP-IN/C						L
1	NP-IN/C						L

Per CompactPCI® Computer Telephony Specification PICMG 2.5 R1.0, April 3, 1998, Table 12

2.0 mm ERmet Hard Metric Connector System

PXI Generic Peripheral Slot Pinout



2.0 mm ERmet

PIN	Row F	Row E	Row D	Row C	Row B	Row A	PMC Slot		
22	GND	PXI_RSVA22	PXI_RSVB22	PXI_RSVC22	PXI_RSVD22	PXI_RSVE22	GND	P2/J2	
21	GND	PXI_LBR0	GND	PXI_LBR1	PXI_LBR2	PXI_LBR3	GND		
20	GND	PXI_LBL4	PXI_LBR5	PXI_LBL0	GND	PXI_LBL1	GND		
19	GND	PXI_LBL2	GND	PXI_LBL3	PXI_LBL4	PXI_LBL5	GND		
18	GND	PXI_TRIG3	PXI_TRIG4	PXI_TRIG5	GND	PXI_TRIG6	GND		
17	GND	PXI_TRIG2	GND	PRST#	PXI_STAR	PXI_CLK10	GND		
16	GND	PXI_TRIG1	PXI_TRIG0	DEG#	GND	PXI_TRIG7	GND		
15	GND	PXI_BRSVA15	GND	FAL#	PXI_LBL6	PXI_LBR6	GND		
14	GND	AD[35]	AD[34]	AD[33]	GND	AD[32]	GND		
13	GND	AD[38]	GND	V[1/0]	AD[37]	AD[36]	GND		
12	GND	AD[42]	AD[41]	AD[40]	GND	AD[39]	GND		
11	GND	AD[45]	GND	V[1/0]	AD[44]	AD[43]	GND		
10	GND	AD[49]	AD[48]	AD[47]	GND	AD[46]	GND		
9	GND	AD[52]	GND	V[1/0]	AD[51]	AD[50]	GND		
8	GND	AD[56]	AD[55]	AD[54]	GND	AD[53]	GND		
7	GND	AD[59]	GND	V[1/0]	AD[58]	AD[57]	GND		
6	GND	AD[63]	AD[62]	AD[61]	GND	AD[60]	GND		
5	GND	C/BE[5]#	GND	V[1/0]	C/BE[4]#	PAR64	GND		
4	GND	V[1/0]	PXI_BRSVB4	C/BE[7]#	GND	C/BE[6]#	GND		
3	GND	PXI_LBR7	GND	PXI_LBR8	PXI_LBR9	PXI_LBR10	GND		
2	GND	PXI_LBR11	PXI_LBR12	SYSEN#	PXI_LBL7	PXI_LBL8	GND		
1	GND	PXI_LBL9	GND	PXI_LBL10	PXI_LBL11	PXI_LBL12	GND		
25	GND	5V	REQ64#	ENUM#	3.3V	5V	GND	P1/J1	
24	GND	AD[1]	5V	V[1/0]	AD[0]	ACK64#	GND		
23	GND	3.3V	AD[4]	AD93]	5V	AD[2]	GND		
22	GND	AD[7]	GND	3.3V	AD[6]	AD[5]	GND		
21	GND	3.3V	AD[9]	AD[8]	M66EN	C/BE[0]#	GND		
20	GND	AD[12]	GND	V[1/0]	AD[11]	AD[10]	GND		
19	GND	3.3V	AD[15]	AD[14]	GND	AD[13]	GND		
18	GND	SERR#	GND	3.3V	PAR	C/BE[1]#	GND		
17	GND	3.3V	SDONE	SBO#	GND	PERR#	GND		
16	GND	DEVSEL#	GND	V[1/0]	STOP#	LOCK#	GND		
15	GND	3.3V	FRAME#	IRDY	GND	TRDY#	GND		
12-14	GND	Key Area							
11	GND	AD[8]	AD[17]	AD[16]	GND	C/BE[2]#	GND		
10	GND	AD[21]	GND	3.3V	AD[20]	AD[19]	GND		
9	GND	C/BE[3]#	IDSEL	AD[23]	GND	AD[22]	GND		
8	GND	AD[26]	GND	V[1/0]	AD[25]	AD[24]	GND		
7	GND	AD[30]	AD[29]	AD[28]	GND	AD[27]	GND		
6	GND	REQ#	GND	3.3V	CLK	AD[31]	GND		
5	GND	BRSVP1A5	BRSVP1B5	RST#	GND	GNT#	GND		
4	GND	BRSVP1A4	GND	V[1/0]	INTP	INTS	GND		
3	GND	INTA#	INTB#	INTC#	5V	INTD#	GND		
2	GND	TCK	5V	TMS	TDO	TDI	GND		
1	GND	5V	-12V	TRST#	+12V	5V	GND		
PIN	Row F	Row E	Row D	Row C	Row B	Row A	PMC Slot		

Per PXI Specification R1.0 August 20, 1997, Table 4.9
 Signals in Bold are PXI specific

2.0 mm ERmet Hard Metric Connector System

PXI System Slot Pinout



PIN	Z	A	B	C	D	E	F	
22	GND	PXI_RSVA22	PXI_RSVB22	PXI_RSVC22	PXI_RSVD22	PXI_RSVE22	GND	P2/J2
21	GND	CLK6	GND	RSV	RSV	RSV	GND	
20	GND	CLK5	GND	RSV	GND	RSV	GND	
19	GND	GND	GND	RSV	RSV	RSV	GND	
18	GND	PXI_TRIG3	PXI_TRIG4	PXI_TRIG5	GND	PXI_TRIG6	GND	
17	GND	PXI_TRIG2	GND	PRST#	REQ6#	GNT6#	GND	
16	GND	PXI_TRIG1	PXI_TRIG0	DEG#	GND	PXI_TRIG7	GND	
15	GND	PXI_BRSA15	GND	FAL#	REQ5#	GBT5#	GND	
14	GND	AD[35]	AD[34]	AD[33]	GND	AD[32]	GND	
13	GND	AD[38]	GND	V[I/O]	AD[37]	AD[36]	GND	
12	GND	AD[42]	AD[41]	AD[40]	GND	AD[39]	GND	
11	GND	AD[45]	GND	V[I/O]	AD[44]	AD[43]	GND	
10	GND	AD[49]	AD[48]	AD[47]	GND	AD[46]	GND	
9	GND	AD[52]	GND	V[I/O]	AD[51]	AD[50]	GND	
8	GND	AD[56]	AD[55]	AD[54]	GND	AD[53]	GND	
7	GND	AD[59]	GND	V[I/O]	AD[58]	AD[57]	GND	
6	GND	AD[63]	AD[62]	AD[61]	GND	AD[60]	GND	
5	GND	C/BE[5]#	GND	V[I/O]	C/BE[4]#	PAR6	GND	
4	GND	V[I/O]	PXI_BRSVB4	C/BE[7]#	GND	C/BE[6]#	GND	
3	GND	CLK4	GND	GNT3#	REQ4#	GNT4#	GND	
2	GND	CLK2	CLK3	SYSEN#	GNT2#	REQ3#	GND	
1	GND	CLK1	GND	REQ1#	GNT1#	REQ2#	GND	
25	GND	5V	REQ64#	ENUM#	3.3V	5V	GND	
24	GND	AD[1]	5V	V[1/0]	AD[0]	ACK64#	GND	
23	GND	3.3V	AD[4]	AD[3]	5V	AD[2]	GND	
22	GND	AD[7]	GND	3.3V	AD[6]	AD[5]	GND	
21	GND	3.3V	AD[9]	AD[8]	M66EN	C/BE[0]#	GND	
20	GND	AD[12]	GND	V[I/O]	AD[11]	AD[10]	GND	
19	GND	3.3V	AD[15]	AD[14]	GND	AD[13]	GND	
18	GND	SERR#	GND	3.3V	PAR	C/BE[1]	GND	
17	GND	3.3V	SDONE	SBO#	GND	PERR#	GND	
16	GND	DEVSEL#	GND	V[I/O]	STOP#	LOCK#	GND	
15	GND	3.3V	FRAME#	IRDY#	GND	TRDY#	GND	
12-14		Key Area						
11	GND	AD[18]	AD[17]	AD[16]	GND	C/BE[2]#	GND	
10	GND	AD[21]	GND	3.3V	AD[20]	AD[19]	GND	
9	GND	C/BE[3]#	IDSEL	AD[23]	GND	AD[22]	GND	
8	GND	AD[26]	GND	V[I/O]	AD[25]	AD[24]	GND	
7	GND	AD[30]	AD[29]	AD[28]	GND	AD[27]	GND	
6	GND	REQ#	GND	3.3V	CLK	AD[31]	GND	
5	GND	BRSVP1A5	BRSVP1B5	RST#	GND	GNT#	GND	
4	GND	BRSVP1A4	GND	V[I/O]	INTP	INTS	GND	
3	GND	INTA#	INTB#	INTC#	5V	INTD#	GND	
2	GND	TCK	5V	TMS	TDO	TDI	GND	
1	GND	5V	-12V	TRST#	+12V	5V	GND	
PIN	Z	A	B	C	D	E	F	

Per PXI Specification R1.0 August 20, 1997, Table 4.10
 Signals in Bold are PXI specific

2.0 mm ERmet Hard Metric Connector System

PXI Star Trigger Slot Pinout



2.0 mm ERmet

PIN	Z	A	B	C	D	E	F	
22	GND	PXI_RSVA22	PXI_RSVB22	PXI_RSVC22	PXI_RSVD22	PXI_RSVE22	GND	P2/J2
21	GND	PXI_LBR0	GND	PXI_LBR1	PXI_LBR2	PXI_LBR3	GND	
20	GND	PXI_LBR4	PXI_LBR5	PXI_STAR0	GND	PXI_STAR1	GND	
19	GND	PXI_STAR2	GND	PXI_STAR3	PXI_STAR4	PXI_STAR5	GND	
18	GND	PXI_TRIG3	PXI_TRIG4	PXI_TRIG5	GND	PXI_TRIG6	GND	
17	GND	PXI_TRIG2	GND	PRST#	PXI_CLK10_IN	PXI_CLK10	GND	
16	GND	PXI_TRIG1	PXI_TRIG0	DEG#	GND	PXI_TRIG7	GND	
15	GND	PXI_BRSVA15	GND	FAL#	PXI_STAR6	PXILBR6	GND	
14	GND	AD[35]	AD[34]	AD[33]	GND	AD[32]	GND	
13	GND	AD[38]	GND	V[I/O]	AD[37]	AD[36]	GND	
12	GND	AD[42]	AD[41]	AD[40]	GND	AD[39]	GND	
11	GND	AD[45]	GND	V[I/O]	AD[44]	AD[43]	GND	
10	GND	AD[49]	AD[48]	AD[47]	GND	AD[46]	GND	
9	GND	AD[52]	GND	V[I/O]	AD[51]	AD[50]	GND	
8	GND	AD[56]	AD[55]	AD[54]	GND	AD[53]	GND	
7	GND	AD[59]	GND	V[I/O]	AD[58]	AD[57]	GND	
6	GND	AD[63]	AD[62]	AD[61]	GND	AD[60]	GND	
5	GND	C/BE[5]#	GND	V[I/O]	C/BE[4]#	PAR64	GND	
4	GND	V[I/O]	PXI_BRSVB4	C/BE[7]#	GND	C/BE[6]#	GND	
3	GND	PXI_LBR7	GND	PXI_LBR8	PXI_LBR9	PXI_LBR10	GND	
2	GND	PXI_LBR11	PXI_LBR12	SYSEN#	PXI_STAR7	PXI_STAR8	GND	
1	GND	PXI_STAR9	GND	PXI_STAR10	PXI_STAR11	PXI_STAR12	GND	
25	GND	5V	REQ64#	ENUM#	3.3V	5V	GND	
24	GND	AD[1]	5V	V[I/O]	AD[0]	ACK64#	GND	
23	GND	3.3V	AD[4]	AD[3]	5V	AD[2]	GND	
22	GND	AD[7]	GND	3.3V	AD[6]	AD[5]	GND	
21	GND	3.3V	AD[9]	AD[8]	M66#N	C/BE[0]#	GND	
20	GND	AD[12]	GND	V[I/O]	AD[11]	AD[10]	GND	
19	GND	3.3V	AD[15]	AD[14]	GND	AD[13]	GND	
18	GND	SERR#	GND	3.3V	PAR	C/BE[1]#	GND	
17	GND	3.3V	SDONE	SBO#	GND	PERR#	GND	
16	GND	DEVSEL#	GND	V[I/O]	STOP#	LOCK#	GND	
15	GND	3.3V	FRAME#	IRDY#	GND	TRDY#	GND	
12-14			Key Area					
11	GND	AD[18]	AD[17]	AD[16]	GND	C/BE[2]#	GND	
10	GND	AD[21]	GND	3.3V	AD[20]	AD[19]	GND	
9	GND	C/BE[3]#	IDSEL	AD[23]	GND	AD[22]	GND	
8	GND	AD[26]	GND	V[I/O]	AD[25]	AD[24]	GND	
7	GND	AD[30]	AD[29]	AD[28]	GND	AD[27]	GND	
6	GND	REQ#	GND	3.3V	CLK	AD[31]	GND	
5	GND	BRSVP1A5	BRSVP1B5	RST#	GND	GNT#	GND	
4	GND	BRSVP1A4	GND	V[I/O]	INTP	INTS	GND	
3	GND	INTA#	INTB#	INTC#	5V	INTD#	GND	
2	GND	TCK	5V	TMS	TDO	TDI	GND	
1	GND	5V	-12V	TRST#	+12V	5V	GND	
PIN	Z	A	B	C	D	E	F	

Per PXI Specification R1.0 August 20, 1997, Table 4.11
 Signals in Bold are PXI specific

2.0 mm ERmet Hard Metric Connector System

VME64x on CompactPCI® J4/P4 and J5/P5 Pin Assignments



PIN	A	B	C	D	E	F	
22	ResU(1)	+3.3V	D00	D08	D01	GND	P5/J5 C O N N E C T O R
21	ResU(1)	ACFAIL*	+3.3V	D09	D02	GND	
20	GND	SYSCLK	D10	+3.3V	BERR*	GND	
19	MPR	+3.3V	D03	D11	D04	GND	
18	MCLK	SYSFAIL	+3.3V	D12	D05	GND	
17	GND	SYSRST*	D13	+3.3V	RTRY1*	GND	
16	MSD	+3.3V	D06	D14	D07	GND	
15	MMD	AM5	+3.3V	D15	LWORD*	GND	
14	GND	WRITE*	A23	+3.3V	DS1*	GND	
13	MCTL	+3.3V	A22	A21	A20	GND	
12	BCLR*	AM0	+V1	A19	A18	GND	
11	GND	AMI	A17	+V2	DS0*	GND	
10	BBSY*	+3.3V	A16	A15	A07	GND	
9	BGOIN*	AM2	-V1	A14	A06	GND	
8	GND	AM3	A13	-V2	DTACK*	GND	
7	BGOOUT*	GAP*	A05	A12	A04	GND	
6	BG1IN*	AM4	GA0*	A11	A03	GND	
5	GND	ResB[z13] ⁽²⁾	A10	GA1*	AS*	GND	
4	BG1OUT*	GA2*	A02	A09	A01	GND	
3	BG2IN*	RsvB[z15]	GA3*	A08	A24	GND	
2	GND	RsvB[z17]	A25	GA4*	PETRY*	GND	
1	BG2OUT*	+5V	A26	A27	A28	GND	
25	BG3IN*	RsvB[z19]	+5V	A29	A30	GND	
24	GND	RsvB[z21]	A31	+5V	RsvB[d19]	GND	
23	BG3OUT*	+5V	D16	D17	D18	GND	
22	BR0*	RsvB[z23]	+5V	D19	D20	GND	
21	GND	RsvB[z25]	D21	+5V	RsvB[d21]	GND	
20	BR1*	+5V	D22	D23	D24	GND	
19	BR2*	SERA	+5V	D25	D26	GND	
18	GND	SERB	D27	+12V	RsvB[d23]	GND	
17	BR3*	-12V	D28	D29	D30	GND	
16	LI/!(1)	SBB	VPC(2)	D31	ResB[d25] ⁽²⁾	GND	
15	LI/0*(1)	SBA	ResU(1)	GND(3)	ResB[z27] ⁽²⁾	GND	
12-14	Key Area						
11	IACK*	IACKIN*	IACKOUT*	IRQ7*	IRQ6*	GND	
10	IRQ5*	IRQ4*	IRQ3*	IRQ2*	IRQ1*	GND	
9	GND	GND	GND	GND	GND	GND	
8	UD	UD	UD	UD	UD	GND	
7	UD	UD	UD	UD	UD	GND	
6	UD	UD	UD	UD	UD	GND	
5	UD	UD	UD	UD	UD	GND	
4	UD	UD	UD	UD	UD	GND	
3	UD	UD	UD	UD	UD	GND	
2	UD	UD	UD	UD	UD	GND	
1	UD	UD	UD	UD	UD	GND	
PIN	A	B	C	D	E	F	

Per PICMG 2.2 R1.0 August 7, 1998, Table 1

Notes:

- (1) These signals are not bused (feed through the backplane).
 - (2) ResB is the ResBus (reserved bused) signal pins
- Connector Key is Reseda Green (ERNI P/N 043346 male, 043336 female)

2.0 mm ERmet Hard Metric Connector System

PMC Mezzanine Card I/O Pin Assignments



2.0 mm ERmet

Single PMC's I/O Signal Mapping to CompactPCI® 3U J2 Connector

PIN	Row F	Row E	Row D	Row C	Row B	Row A	J2 C O N N E C T O R
22	GND	UD	UD	UD	UD	UD	
21	GND	UD	UD	UD	UD	UD	
20	GND	UD	UD	UD	UD	UD	
19	GND	UD	UD	UD	UD	UD	
18	GND	UD	UD	UD	UD	UD	
17	GND	UD	UD	UD	UD	UD	
16	GND	UD	UD	UD	UD	UD	
15	GND	UD	UD	UD	UD	UD	
14	GND	+5V	+5V	+3.3V	+3.3V	+3.3V	
13	GND	1	2	3	4	5	
12	GND	6	7	8	9	10	
11	GND	11	12	13	14	15	
10	GND	16	17	18	19	20	
9	GND	21	22	23	24	25	
8	GND	26	27	28	29	30	
7	GND	31	32	33	34	35	
6	GND	36	37	38	39	40	
5	GND	41	42	43	44	45	
4	GND	46	47	48	49	50	
3	GND	51	52	53	54	55	
2	GND	56	57	58	59	60	
1	GND	61	62	63	64	VI/O	
PIN	Row F	Row E	Row D	Row C	Row B	Row A	

Per PICMG 2.3 R1.0 August 7, 1998, Table 1

Notes: 1. Entries in table are of the PMC Jn4 pin number.

2. UD are the remaining user defined I/O pins that can be used for other I/O functions.

Dual PMC Slot's I/O Signal Mapping to CompactPCI® 6U J3/P3 & J4/P4 Connectors

PIN	Row F	Row E	Row D	Row C	Row B	Row A	PMC Slot	J4 C O N N E C T O R
9	GND	GND	GND	GND	GND	GND		
8	GND	1	2	3	4	5	A	
7	GND	6	7	8	9	10	A	
6	GND	11	12	13	14	15	A	
5	GND	16	17	18	19	20	A	
4	GND	21	22	23	24	25	A	
3	GND	26	27	28	29	30	A	
2	GND	31	32	33	34	35	A	
1	GND	36	37	38	39	40	A	
19	GND	41	42	43	44	45	A	
18	GND	46	47	48	49	50	A	
17	GND	51	52	53	54	55	A	
16	GND	56	57	58	59	60	A	
15	GND	61	62	63	64	VI/O	A	
14	GND	+5V	+5V	+3.3V	+3.3V	+3.3V	A&B	
13	GND	1	2	3	4	5	B	
12	GND	6	7	8	9	10	B	
11	GND	11	12	13	14	15	B	
10	GND	16	17	18	19	20	B	
9	GND	21	22	23	24	25	B	
8	GND	26	27	28	29	30	B	
7	GND	31	32	33	34	35	B	
6	GND	36	37	38	39	40	B	
5	GND	41	42	43	44	45	B	
4	GND	46	47	48	49	50	B	
3	GND	51	52	53	54	55	B	
2	GND	56	57	58	59	60	B	
1	GND	61	62	63	64	VI/O	B	
PIN	Row F	Row E	Row D	Row C	Row B	Row A	PMC Slot	

Per PICMG 2.3 R1.0 August 7, 1998, Table 2

Notes: 1. Entries in table are of the PMC Jn4 pin number.

2.0 mm ERmet Hard Metric Connector System

PMC Mezzanine Card I/O Pin Assignments



Single PMC Slot's I/O Signal Mapping to CompactPCI® J5/P5 Connector

PIN	Row F	Row E	Row D	Row C	Row B	Row A	J5 C O N N E C T O R
22	GND	1	2	3	4	5	
21	GND	6	7	8	9	10	
20	GND	11	12	13	14	15	
19	GND	16	17	18	19	20	
18	GND	21	22	23	24	25	
17	GND	16	17	18	19	30	
16	GND	31	32	33	34	35	
15	GND	36	37	38	39	40	
14	GND	41	42	43	44	45	
13	GND	46	47	48	49	50	
12	GND	51	52	53	54	55	
11	GND	1	2	3	4	5	
10	GND	6	7	8	9	10	
9	GND	11	12	13	14	15	
8	GND	16	17	18	19	20	
7	GND	21	22	23	24	25	
6	GND	26	27	28	29	30	
5	GND	31	32	33	34	35	
4	GND	36	37	38	39	40	
3	GND	41	42	43	44	45	
2	GND	46	47	48	49	50	
1	GND	51	52	53	54	55	
PIN	Row F	Row E	Row D	Row C	Row B	Row A	

Per PICMG 2.3 R1.0 August 7, 1998, Table 3

- Notes: 1. Entries in table are of the PMC Jn4 pin number.
 2. UD are the remaining user defined I/O pins that can be used for other I/O functions.

Dual PMC Slot's I/O Signal Mapping to CompactPCI® J5/P5 Connector

PIN	Row F	Row E	Row D	Row C	Row B	Row A	PMC Slot	J5 C O N N E C T O R
22	GND	1	2	3	4	5	A	
21	GND	6	7	8	9	10	A	
20	GND	11	12	13	14	15	A	
19	GND	16	17	18	19	20	A	
18	GND	21	22	23	24	25	A	
17	GND	16	17	18	19	30	A	
16	GND	31	32	33	34	35	A	
15	GND	36	37	38	39	40	A	
14	GND	41	42	43	44	45	A	
13	GND	46	47	48	49	50	A	
12	GND	51	52	53	54	55	A	
11	GND	1	2	3	4	5	B	
10	GND	6	7	8	9	10	B	
9	GND	11	12	13	14	15	B	
8	GND	16	17	18	19	20	B	
7	GND	21	22	23	24	25	B	
6	GND	26	27	28	29	30	B	
5	GND	31	32	33	34	35	B	
4	GND	36	37	38	39	40	B	
3	GND	41	42	43	44	45	B	
2	GND	46	47	48	49	50	B	
1	GND	51	52	53	54	55	B	
PIN	Row F	Row E	Row D	Row C	Row B	Row A	PMC Slot	

Per PICMG 2.3 R1.0 August 7, 1998, Table 4

- Notes: 1. Entries in table are of the PMC Jn4 pin number.

2.0 mm ERmet Hard Metric Connector System

IP Mezzanine Module I/O Pin Assignments



2.0 mm ERmet

I/O Signal Mapping to CompactPCI® J2 Connector

PIN	Row F	Row E	Row D	Row C	Row B	Row A	IP Module	J2 C O N N E C T O R
22	GND	B5	B4	B3	B2	B1	IP-B	
21	GND	B10	B9	B8	B7	B6	IP-B	
20	GND	B15	B14	B13	B12	B11	IP-B	
19	GND	B20	B19	B18	B17	B16	IP-B	
18	GND	B25	B24	B23	B22	B21	IP-B	
17	GND	B30	B29	B28	B27	B26	IP-B	
16	GND	B35	B34	B33	B32	B31	IP-B	
15	GND	B40	B39	B38	B37	B36	IP-B	
14	GND	B45	B44	B43	B42	B41	IP-B	
13	GND	B50	B49	B48	B47	B46	IP-B	
12	GND	+5V	+5V	+3.3V	+3.3V	+3.3V		
11	GND	A5	A4	A3	A2	A1	IP-A	
10	GND	A10	A9	A8	A7	A6	IP-A	
9	GND	A15	A14	A13	A12	A11	IP-A	
8	GND	A20	A19	A18	A17	A16	IP-A	
7	GND	A25	A24	A23	A22	A21	IP-A	
6	GND	A30	A29	A28	A27	A26	IP-A	
5	GND	A35	A34	A33	A32	A31	IP-A	
4	GND	A40	A39	A38	A37	A36	IP-A	
3	GND	A45	A44	A43	A42	A41	IP-A	
2	GND	A50	A49	A48	A47	A46	IP-A	
1	GND	+5V	+5V	+3.3V	+3.3V	+3.3V		
PIN	Row F	Row E	Row D	Row C	Row B	Row A	IP Module	

Per PICMG 2.4 R1.0 August 7, 1998, Table 1

2.0 mm ERmet Hard Metric Connector System

IP Mezzanine Module I/O Pin Assignments



I/O Signal Mapping to CompactPCI® J5 and J4 Connector

PIN	Row F	Row E	Row D	Row C	Row B	Row A	IP Module	J5 C O N N E C T O R
22	GND	D5	D4	D3	D2	D1	IP-D	
21	GND	D10	D9	D8	D7	D6	IP-D	
20	GND	D15	D14	D13	D12	D11	IP-D	
19	GND	D20	D19	D18	D17	D16	IP-D	
18	GND	D25	D24	D23	D22	D21	IP-D	
17	GND	D30	D29	D28	D27	D26	IP-D	
16	GND	D35	D34	D33	D32	D31	IP-D	
15	GND	D40	D39	D38	D37	D36	IP-D	
14	GND	D45	D44	D43	D42	D41	IP-D	
13	GND	D50	D49	D48	D47	D46	IP-D	
12	GND	+5V	+5V	+3.3V	+3.3V	+3.3V		
11	GND	C5	C4	C3	C2	C1	IP-C	
10	GND	C10	C9	C8	C7	C6	IP-C	
9	GND	C15	C14	C13	C12	C11	IP-C	
8	GND	C20	C19	C18	C17	C16	IP-C	
7	GND	C25	C24	C23	C22	C21	IP-C	
6	GND	C30	C29	C28	C27	C26	IP-C	
5	GND	C35	C34	C33	C32	C31	IP-C	
4	GND	C40	C39	C38	C37	C36	IP-C	
3	GND	C45	C44	C43	C42	C41	IP-C	
2	GND	C50	C49	C48	C47	C46	IP-C	
1	GND	+5V	+5V	+3.3V	+3.3V	+3.3V		
25	GND	B5	B4	B3	B2	B1	IP-B	
24	GND	B10	B9	B8	B7	B6	IP-B	
23	GND	B15	B14	B13	B12	B11	IP-B	
22	GND	B20	B19	B18	B17	B16	IP-B	
21	GND	B25	B24	B23	B22	B21	IP-B	
20	GND	B30	B29	B28	B27	B26	IP-B	
19	GND	B35	B34	B33	B32	B31	IP-B	
18	GND	B40	B39	B38	B37	B36	IP-B	
17	GND	B45	B44	B43	B42	B41	IP-B	
16	GND	B50	B49	B48	B47	B46	IP-B	
15	GND	+5V	+5V	+3.3V	+3.3V	+3.3V		
12 – 14	Key Area							
11	GND	A5	A4	A3	A2	A1	IP-A	
10	GND	A10	A9	A8	A7	A6	IP-A	
9	GND	A15	A14	A13	A12	A11	IP-A	
8	GND	A20	A19	A18	A17	A16	IP-A	
7	GND	A25	A24	A23	A22	A21	IP-A	
8	GND	A20	A19	A18	A17	A16	IP-A	
7	GND	A25	A24	A23	A22	A21	IP-A	
6	GND	A30	A29	A28	A27	A26	IP-A	
5	GND	A35	A34	A33	A32	A31	IP-A	
4	GND	A40	A39	A38	A37	A36	IP-A	
3	GND	A45	A44	A43	A42	A41	IP-A	
2	GND	A50	A49	A48	A47	A46	IP-A	
1	GND	+5V	+5V	+3.3V	+3.3V	+3.3V		
PIN	Row F	Row E	Row D	Row C	Row B	Row A	IP Module	J4 C O N N E C T O R

Per PICMG 2.4 R1.0 August 7, 1998, Table 2



BELLCORE Requirements Summary
 In accordance with Bellcore GR-1217

	CENTRAL OFFICE	UNCONTROLLED ENVIRONMENT
Prequalification Tests for Quality Level II, Level III	Shocks and Vibration - 24 hr., 18 shocks Temperature Life - 500 hr., 85°C Humidity and Temp Cycle - 25°C – 65°C MFG TEST - 10 days, less gas concentration	Shocks and Vibration - 24 hr., 18 shocks Temperature Life - 1,000 hr., 105°C Humidity and Temp Cycle - 5°C – 85°C MFG TEST - 20 days, more gas concentration
Level I	<ul style="list-style-type: none"> • Commercial Grade • Vendor Qualification Process 	<ul style="list-style-type: none"> • Commercial Grade • Vendor Qualification Process
Level II	Level I with: <ul style="list-style-type: none"> • Tested for less than 1 in 1,000 failures over 10 year life • Monitor parametric attributes • Approved by OEM • Ship to stock allowed • Requalify every 5 years 	Level I with: <ul style="list-style-type: none"> • Tested for less than 1 in 1,000 failures over 10 year life • Monitor parametric attributes • Approved by OEM • Ship to stock allowed • Requalify every 5 years
Level III	Level II with: <ul style="list-style-type: none"> • Tested for less than 1 in 10,000 failures over 25 year life • Monitor parametric attributes • Ship to stock allowed, provided that connector manufacturer's data are reviewed on lot-on-lot basis • Requalify every 3 years 	Level II with: <ul style="list-style-type: none"> • Tested for less than 1 in 10,000 failures over 25 year life • Monitor parametric attributes • Ship to stock allowed, provided that connector manufacturer's data are reviewed on lot-on-lot basis • Requalify every 3 years



Annular Ring – The circular area around a hole that is measured by the difference between the radius of the wall of the hole, subtracted from the radius of the clearance or pad around the hole.

ANSI – Abbreviation for American National Standards Institute.

Artwork – The representation of the electrical layout of a printed circuit on a transparency.

Attenuation – When a signal travels along the bus, its amplitude decreases due to energy losses from heating, radiation, and so forth.

AWG – Abbreviation for American Wire Gage. A particular series of specified diameters and thicknesses established as a standard in the U.S.A. and used for nonferrous sheets, rods and wires.

Backplane – (1) A wiring board usually constructed as a printed circuit, used in micro and mini computers to provide the required connections between logic, memory and I/O modules. (2) A two-sided or multilayer printed circuit board into which function cards can be plugged. The backplane transfers signals between the function cards. Mounted on the component side of the backplane are connectors into which function cards can be plugged.

On the solder side of the backplane are termination points (studs, power bugs, quick disconnects) for the distribution of power and ground.

Bellcore – Bell Research Corporation, originally the research division for AT&T.

Bus – A circuit over which data or power is transmitted.

Bus Structure – A set of rules governing the circuit design of a system such as: CompactPCI®, VME, Multibus I, Multibus II and Q-Bus, to name a few.

Characteristic Impedance – Impedance is referred to as Z_0 , in ohms. It is the resistance seen by a digital signal and is measured between the signal line and the reference plane. This impedance is a function of the signal line geometry and is independent of the line length. Impedance is the key parameter which interrelates all performance characteristics of the backplane, including delay, noise and distributed capacitance.

CompactPCI® – A bus structure developed by the PICMG based on the desktop PCI architecture.

Compliant – A pin whose physical structure is designed to elastically deform upon insertion into a hole.

Component Side – The side of a printed wiring board or backplane into which connectors, resistors, capacitors and so forth are inserted.

Component Density – The ratio of the number of components to a given area of a board.

Conductor Width – The width of a given trace.

Conductor Spacing – The distance between adjacent traces on a printed wiring board.

Crosstalk – (1) The interaction observed due to electromagnetic coupling of adjacent conductors. (2) A false signal picked up by a signal line (in an inductive manner) from an adjacent signal line.

Current – The net transfer of electric charge, per unit time, along a conductor. An amount equal to the voltage/resistance and measured in Amperes.

Data Bus – A bus structure used specifically to transmit data, or bits of information.

Date Code – Stamped or printed on a component the week and year the component was made (i.e. 9023 is the 23rd week of the year 1990, or June 3rd-7th, 1990).

Daughter Card – Same as function card or function board.

Decommitted – To physically remove material from an area of a board so as to break the electrical connection to that plane.

Decouple – To prevent transfer or feedback of energy from one circuit to another.

Dielectric – (1) A material which is an electrical insulator that can sustain an electrical field with minimum power loss. (2) Any insulating medium that intervenes between two conductors.

Dielectric Constant – The property of a material that governs the propagation delay of a signal it surrounds, denoted by ϵ_r .

DIN – (1) Stands for Deutsches Institut für Normung, a German organization which established many mechanical specifications for connectors and packaging. (2) Vernacular for Standard European connector having 96 pins arranged in 3 rows of 32 pins each. The rows are labeled A, B, C.

DIP – Abbreviation for Dual-In-line Package. A device that has two rows or parallel pins. Usually the pins in each row are on .100" centers.

Discrete Resistor – An individual resistor, as opposed to a resistor network.

Distributed Capacitance – Distributed capacitance, referred to as C_0 , is the amount of capacitance per unit length of a signal line.

ECL – Abbreviation for Emitter-Coupled-Logic, a form of current-mode logic in which the emitters of two transistors are connected to a current carrying resistor in such a way that only one will turn on at time.

ECTF – The Enterprise Computer Telephony Forum is a trade association that has developed a number of specifications related to computer telephony. Their web address is: <http://www.ectf.org>.

EIA – Electronics Industry Association.

2.0 mm ERmet Hard Metric Connector System

Glossary Of Terminology



EMI – Electromagnetic interference.

Etch – To incise an area of a printed wiring board by immersing the board in an acid batch. The parts of the board not covered with an acid-resistant coating will be eroded.

ERNIPRESS – The particular compliant section design utilized by ERNI for many DIN 41612 and D-Sub pressfit contacts. This coined, elastic section provides a very reliable gas tight connection with the plated through hole in the backplane or daughter card.

Eye of the Needle – This is the compliant section design utilized by ERNI for our 2 mm ERmet pressfit contacts. This pierced and coined elastic section provides a very reliable gas tight connection with the plated through hole in the backplane or daughter card.

Function Card – A printed circuit board that plugs into a slot position of a backplane. Function cards can be custom designed by the user or bought as a standard off-the-shelf item. A series of these cards can make up a system or sub-system to run machinery or many other electronic functions.

GND – An abbreviation for ground. The potential referred to as zero volts. An electrical connection between any circuit and the reference potential.

Ground Guard – The pair of traces which surround a third conductor to minimize crosstalk.

Ground Plane – A common conductive surface that receives and returns power/signal transmissions.

Ground Shield – A conductor (usually a plane), at some reference potential (e.g. zero volts), which surrounds some other insulated conductor.

IEC 61076-4-101 – Global specification that governs 2mm Hard Metric equipment practices.

IEC 917 (DIN 43355) – Defines a basic pitch of 0.5 mm, with x 0.5 mm as the multiple pitch, and a system unit of 25 mm. This, in turn, relates to Hard Metric Equipment practices, IEE 1301 and DIN 43356, used for mechanical arrangement of electrical/electronic equipment, including associated board layout and connections.

I/O – Abbreviation for input/output.

IEEE – Abbreviation for the Institute of Electronic and Electrical Engineers.

Impedance – Resistance of a signal line measured in ohms. One of the important electrical characteristics of a backplane, impedance is determined by the physical dimensions of trace width, dielectric thickness, dielectric constant, and so forth.

Inductance – The ratio of the voltage to the rate of change of current in a circuit ($V/\Delta I$).

Layer – A plane in a printed wiring board which has a copper covering in some specified pattern (e.g. plane, traces and pads).

Microstrip – (1) The name given to a signal line referenced above a single ground plane. (2) The outer etched portion of a backplane transmission line.

Output – The current, voltage, power, or signal which a circuit or device delivers.

Terminals where a device delivers its information.

Pad – The circular area that commits a hole to an uncommitted layer or trace.

PCMCIA – (Personal Computer Memory Card International Association). A standard for removable cards.

PICMG – The PCI Industrial Computer Manufacturer's Group is a trade association that has developed a number of specifications related to personal computer architectures and CompactPCI. Their web address is <http://www.picmg.org>.

Pin-out – A term used to describe the actual connections for each pin of a connector on a printed wiring board.

Plated through-hole – A hole in a printed wiring board, used to commit external or internal layers to one another produced by electro deposition of a conductive pattern.

Plating – To form a thin, adherent layer of material (usually metal) on an object.

PMC – PCI mezzanine card interface, defined by IEEE 1386

Pressfit – An interference connection used in the assembly process to eliminate the need for solder to make the electrical connection.

Propagation Delay – (1) Referred to as tpd, commonly expressed in nanoseconds per inch (ns/in.). It is the time required for a pulse to travel through a transmission line system. (2) The time it takes for a signal to spread or distribute across an entire circuit.

Rack – (See Subrack) – A sheet metal assembly that is made up of mounting bars and side plates to which a backplane can be mounted and printed wiring boards can be inserted

Resistance – The opposition that a material or device offers to the flow of current, equal to the voltage drop across the element, divided by the current through the element.

RFI – Radio Frequency Interference.

Risetime – Often designated as tr, in picoseconds. It is the time it takes the signal to transition from 10 percent to 90 percent of its final value.

Skew – The time difference between the arrival of two related signals, often due to differences in their propagation paths.

Shroud – A male connector body designed to fit over the extended tails of a long tail connector which allows a female connector to be mated from the rear side for midplane or rear I/O applications.

2.0 mm ERmet Hard Metric Connector System

Glossary Of Terminology



Signal – An electrical pulse which conducts across a backplane.

Solder or Extended Tail – A term used to specify the length of the pins on any connector. Typically the pins will protrude through the printed wiring board. Extended pins extend much further.

Solder Mask – The coating on a printed wiring board, placed there for protection. Also aids in assembly and soldering.

S-Parameters – A popular mathematical representation of high frequency characteristics of a component such as a connector utilized for signal integrity measurement and analytical techniques. Often utilized in applications where SPICE modeling is not practical.

SPICE – Software Program for Integrated Circuit Emulation. One of several computer based techniques for simulating the electrical performance of various circuit components such as connectors and integrated circuits within a actual or theoretical circuit configuration.

Stripline – (1) The name given to a signal, referenced between two ground planes, at a defined spacing.
(2) The etched portion of a backplane transmission line that is between two ground planes in a multilayer printed circuit board.

Subrack – A card cage assembly, usually designed to support a backplane, card guides and daughter cards.

Terminated – A line or trace is considered terminated at any point there is a resistor connected to it.

Tolerance – The permissible variations in the dimensions of manufactured parts or electrical components.

Trace – The conductor that physically joins two or more points on a printed wiring board.

Transition Board – A perpendicular board assembly used to plug into extended connector terminals on the rear side of the backplane as in mid plane chassis designs or when it is not desirable to utilize cables to interface to the rear connectors.

Transmission Line – A line is referred to as a transmission line when its capacitance and inductance are distributed over the line. Such a line will convey a signal without distortion and will appear as a purely resistive input impedance.

TTL – Transistor-Transistor Logic. A logic circuit containing two transistors, for driving large output capacitances at high speed.

Two Sided – A printed wiring board with only the outer layers containing traces. This product may or may not contain plated through holes.

U – An EIA unit of measurement equal to 1.75" for equipment racks.

Un-terminated – Any bussed trace that is not connected.

Vcc – Typically, the collector voltage level for a transistor. The designation of the primary voltage level on a printed wiring board, usually at the potential of +5 volts.

Via – A plated through-hole that is there for the sole purpose of conducting a signal trace or potential from one layer of the printed wiring board to another.

VITA – The VME International Trade Association is a trade association that supports VME and other imbedded industry computer manufacturers. It also supports an ANSI recognized standards producing organization, the VSO. VITA's web address is <http://www.vita.com>

VME – The initials for the backplane bus architecture known as Versa-Module -Europa.

Voltage – The electromotive force determined by the potential difference between two conductors, measured in volts.

VSO – The VITA Standards Organization. An ANSI recognized standards producing organization concerned with computer architectures. See VITA.

Wirewrap – A termination technique, used mainly to prototype computers and computer systems, identifiable by the presence of elongated pins to which signal wires and voltage and ground connections can be created.

2.0 mm ERmet Hard Metric Connector System

ERNI Customer Request Form



If you need a specially loaded configuration for your application, please use this form. Fill out the grid diagram for the connector style you desire (A, B, C, or M) and mark which pin (A, B, C, D, E, F, K, L, M, N, P, Q, R, S or T) is required in each position. Unloaded positions or rows may be left blank.

Date Submitted _____

Connector Type A

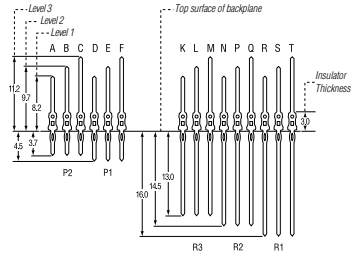
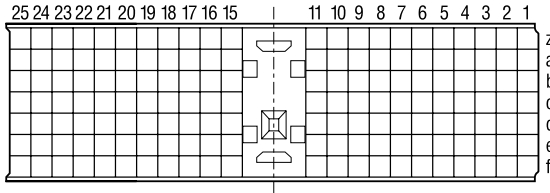

Connector Type B

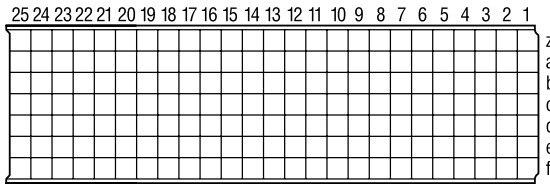

Connector Type C

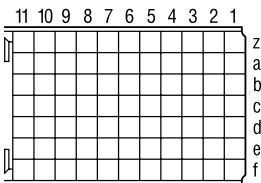

Connector Type M

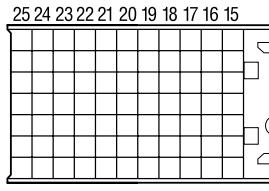

Sample Qty. Required

Date Samples Needed

Estimated Annual Usage

Special Markings or Other Requirements

Connector with location peg Connector without location peg

Name: _____ Tel: _____ Ext. _____

Title: _____ Fax: _____

Company: _____ E-mail: _____

Address: _____

City: _____ State: _____ Zip: _____

2.0 mm ERmet Hard Metric Connector System

ERNI Customer Request Form



2.0 mm ERmet

If you need a specially loaded configuration for your application, please use this form. Fill out the grid diagram for the connector style you desire and mark which pin (A, B, C, D, E, F, K, L, M, N, P, Q, R, S or T) is required in each position. Unloaded positions or rows may be left blank.

Date Submitted _____

Monoblock Connector

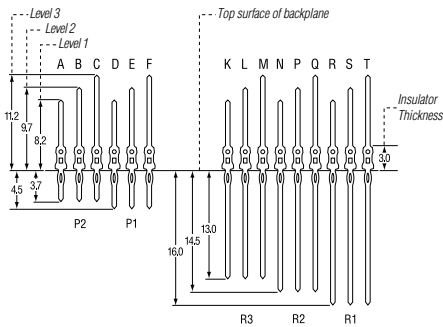
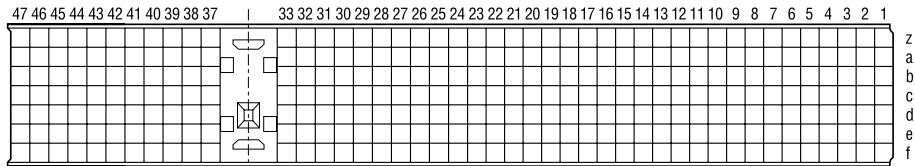

Sample Qty. Required

Date Samples Needed

Estimated Annual Usage

Special Markings or Other Requirements

Name: _____ Tel: _____ Ext. _____

Title: _____ Fax: _____

Company: _____ E-mail: _____

Address: _____

City: _____ State: _____ Zip: _____

2.0 mm ERmet Hard Metric Connector System Applications

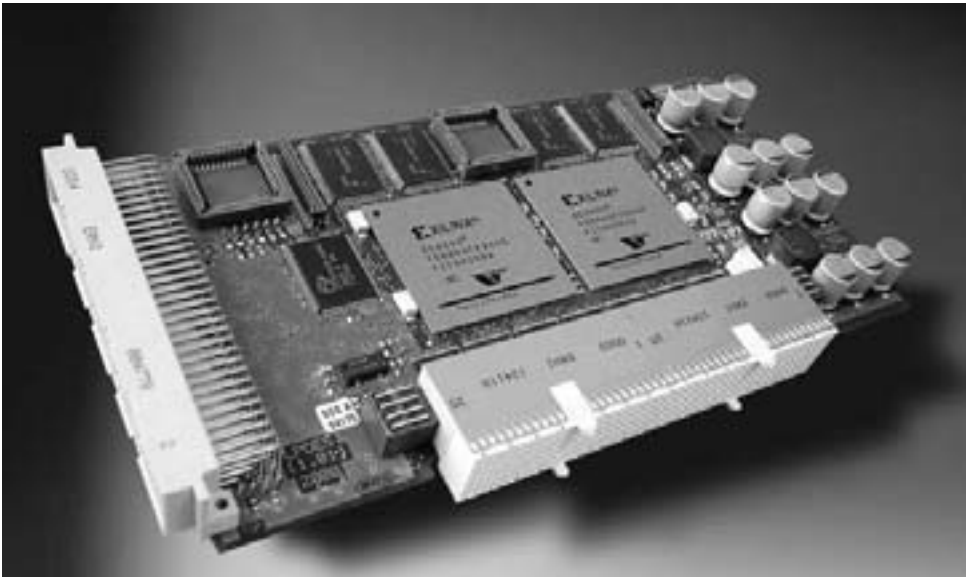
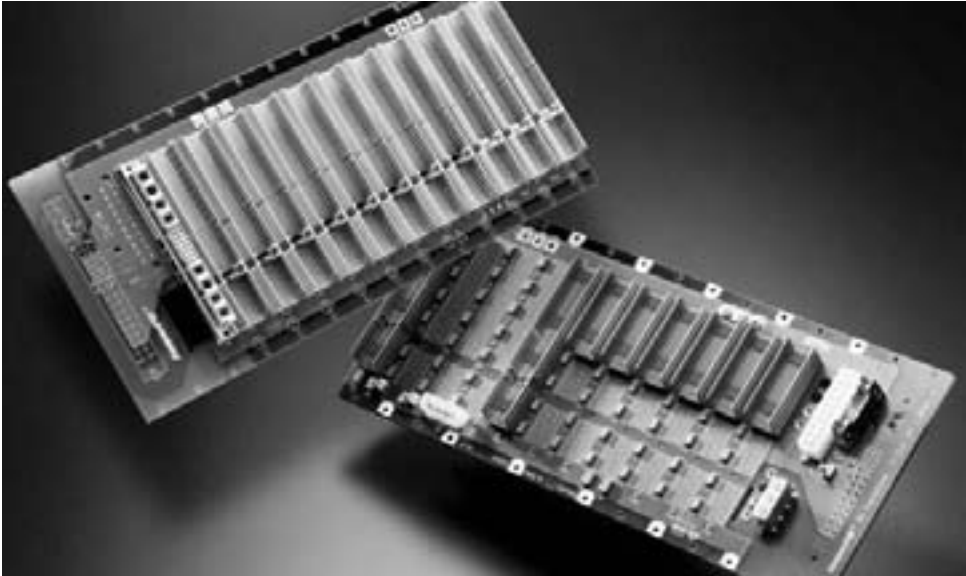

2.0 mm ERmet Hard Metric Connector System

Right Angle Male Connectors Type A for Daughter Cards



2.0 mm ERmet

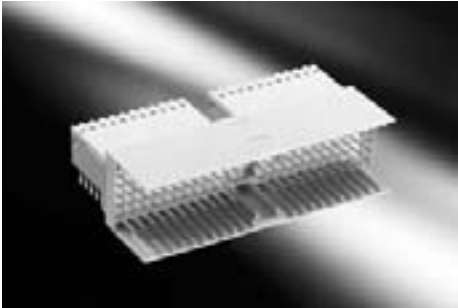

The ERmet type A right angle male connector provides 110 contacts in a 5 row x 25 position (3 positions used by multi-function cavity), fully loaded configuration.

The connector is designed for gas tight, pressfit installation and is provided in two different configurations: with integrated upper ground return shield and without integrated upper ground return shield.

The ERmet type A right angle male connector has a multifunction cavity that incorporates pre-alignment guides and accepts optional coding keys. This connector is designed to be used alone or in conjunction with either a type B or C.

Sequential mating can be achieved by the use of the three available configurations listed below. The available chicklet configurations are denoted A, B, and C, to correspond with the contact mating lengths found in ERmet 2mm male connectors. Within each chicklet, the contact mating length will always be the same and the shield pins will always be Level 3.

Dimensional Drawing

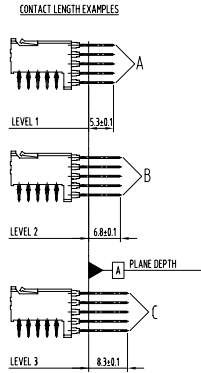
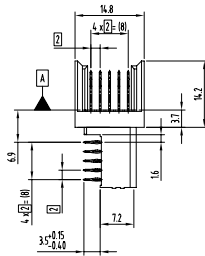
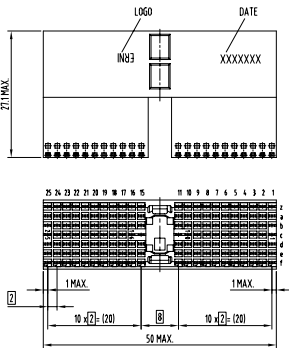

BOARD HOLE PATTERN (COMPONENT MOUNTING SIDE)

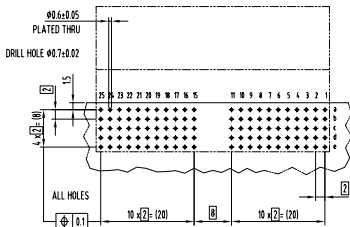

All dimensions in mm

2.0 mm ERmet Hard Metric Connector System

Right Angle Male Connectors Type A for Daughter Cards

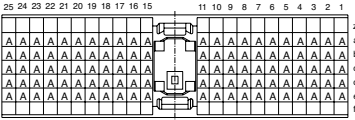
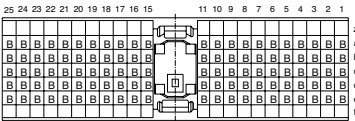
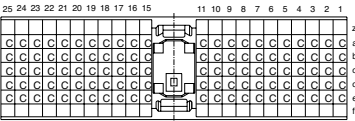
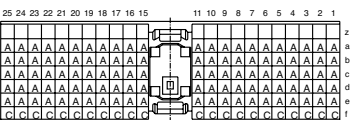
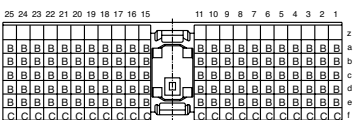
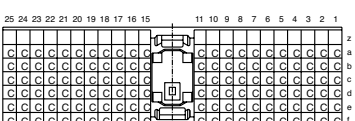

Ordering Information

Configuration	Shielding	Positions	Part Number
Type A 	without shield	25	923761
Type A 	without shield	25	923760
Type A 	without shield	25	923822
Type A 	with shield	25	923763
Type A 	with shield	25	923762
Type A 	with shield	25	923823

2.0 mm ERmet Hard Metric Connector System

Right Angle Male Connectors Type B for Daughter Cards



2.0 mm ERmet

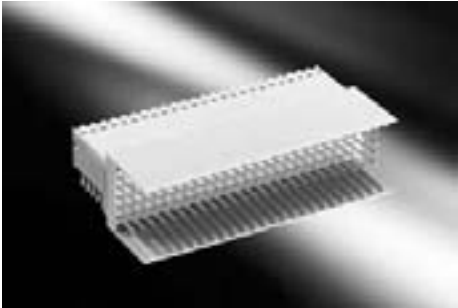

The ERmet type B right angle male connector provides 125 contacts in a 5 row x 25 position fully loaded configuration. The connector is designed for gas tight, pressfit installation and is provided in two different configurations: with integrated upper ground return shield and without integrated upper ground return shield.

The ERmet type B right angle male connector has an uninterrupted pin field with no multifunction cavity. This connector is not designed to be used alone, but is intended to be used in conjunction with either a type A or C ERmet connector.

Sequential mating can be achieved by the use of the three available configurations listed below. The available chicklet configurations are denoted A, B, and C, to correspond with the contact mating lengths found in ERmet 2mm male connectors. Within each chicklet, the contact mating length will always be the same and the shield pins will always be Level 3.

Dimensional Drawing

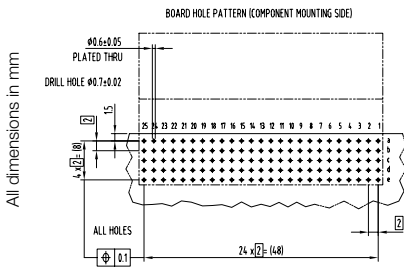
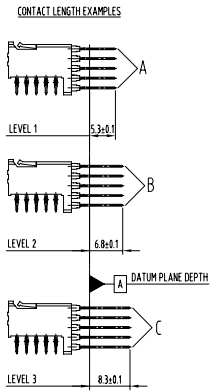
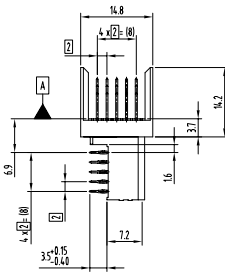
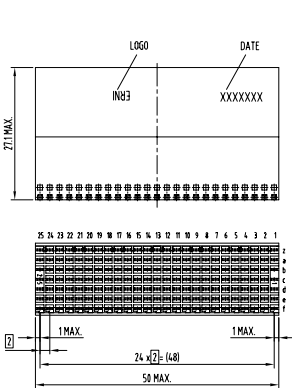

All dimensions in mm

2.0 mm ERmet Hard Metric Connector System

Right Angle Male Connectors Type B for Daughter Cards



Ordering Information

Configuration	Shielding	Positions	Part Number
<p>Type B</p>	without shield	25	923766
<p>Type B</p>	without shield	25	923764
<p>Type B</p>	without shield	25	923768
<p>Type B</p>	with shield	25	923767
<p>Type B</p>	with shield	25	923765
<p>Type B</p>	with shield	25	923769

2.0 mm ERmet Hard Metric Connector System

Right Angle Male Connectors Type C for Daughter Cards



2.0 mm ERmet

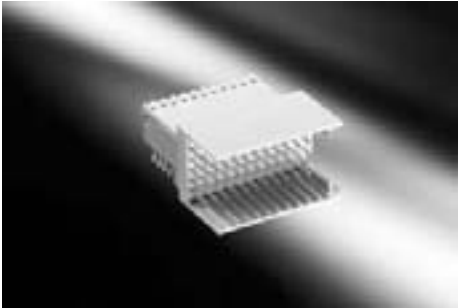

The ERmet type C male connector provides 55 contacts in a 5 row x 11 position fully loaded configuration.

The connector is designed for gas tight, pressfit installation and is provided in two different configurations: with integrated upper ground return shield and without integrated upper ground return shield.

The ERmet type C female connector has pre-alignment guides. This connector can be used alone or in conjunction with either a type A, B, L, M or N ERmet connector, however it can only be installed at the lower end of a connector row.

Sequential mating can be achieved by the use of the three available configurations listed below. The available chicklet configurations are denoted A, B, and C, to correspond with the contact mating lengths found in ERmet 2mm male connectors. Within each chicklet, the contact mating length will always be the same and the shield pins will always be Level 3.

Dimensional Drawing

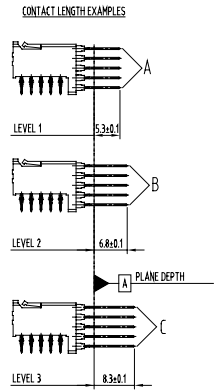
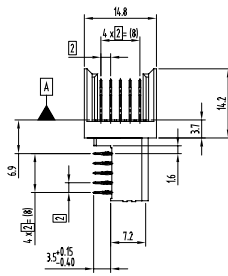
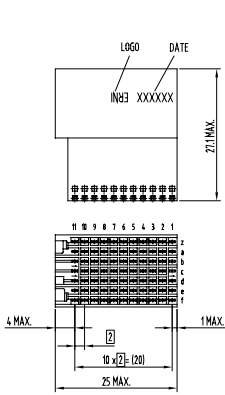

BOARD HOLE PATTERN (COMPONENT MOUNTING SIDE)

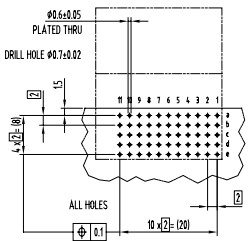

All dimensions in mm

2.0 mm ERmet Hard Metric Connector System

Right Angle Male Connectors Type C for Daughter Cards

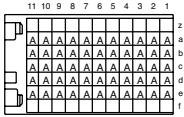
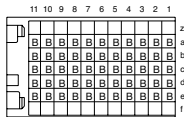
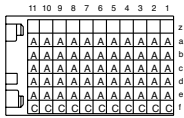
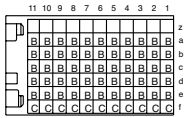
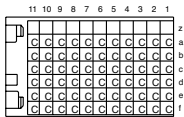

Ordering Information

Configuration	Shielding	Positions	Part Number
Type C 	without shield	11	923828
Type C 	without shield	11	923830
Type C 	with shield	11	923829
Type C 	with shield	11	923831
Type C 	with shield	11	923833

2.0 mm ERmet Hard Metric Connector System

ERmet Thru Hole Reflow (THR) Female Connectors



2.0 mm ERmet

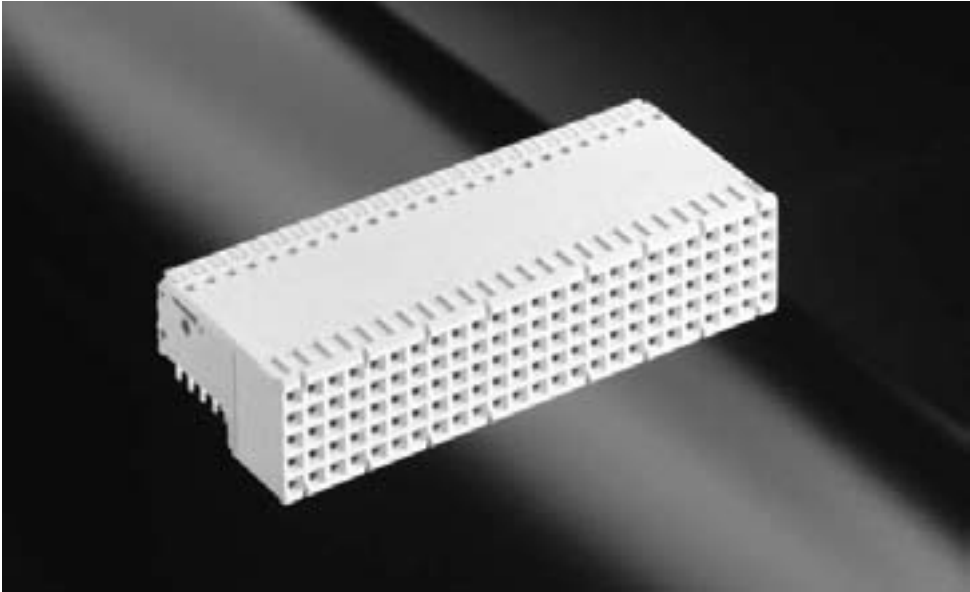

General

In the case of modern boards with SMT population, 2.0 mm H.M. ERmet thru hole reflow (THR) female connectors have been developed. The connectors have been designed for fully automatic SMT assembly. Safe positioning before the SMT soldering process is ensured by means of kinked terminations.

For fully automatic feed-in into the automatic assembly machines, the connectors are supplied in a tray packaging. The high temperature resistant thermoplastic of the insulation body allows for the use of all standard reflow processes.

Technical Characteristics

- Pitch: 2.0 mm
- Modules: A, B, C, AB
- Current rating: 1.5 A (20 °C)
- Air- and creepage distance: 0.6 mm
- Mating cycles: > 250
- Materials:
 - Insulator: LCP
 - Contact: Cu alloy
- Plating:
 - Mating area: Gold plated
 - Termination area: Sn
- PCB-Layout: conform to pressfit Female Connectors
- Tray packaging

2.0 mm ERmet Hard Metric Connector System

ERmet Thru Hole Reflow (THR) Female Connectors



Ordering Information

Configuration	Number of Pins	Termination	Partnumber
Type A without Shield	110	THR	124698
Type A with Shield	110	THR	223214
Type AB without Shield	125	THR	123700
Type AB with Shield	125	THR	154876
Type AB 22 with Shield	110	THR	174402
Type B without Shield	125	THR	124699
Type B with Shield	125	THR	154875
Type B 22 without Shield	110	THR	123768
Type B 22 with Shield	110	THR	154872
Type B 19 without Shield	95	THR	154673
Type B 19 with Shield	95	THR	123796
Type C without Shield	55	THR	223385
Type C with Shield	55	THR	223386

2.0 mm ERmet Hard Metric Connector System

CompactPCI Connectors acc. to PIGMG 2.0 Rev. 3.0



2.0 mm ERmet



General

Late in 1999 PCI Industrial Computer Manufacturers Group (PICMG) introduced the new revision 3.0 of the CompactPCI Core Specification. Version 3.0 of this specification comprises a.o. hot swap and computer telephony specifications such as pin sequencing. For CompactPCI, the metric ERmet connectors are specified in accordance with IEC 61076-4-101 which are available in build types A, B, AB, and as monoblock versions. This new version of the CompactPCI specification has the consequence a.o. that for 3 HE backplanes on position P2 a male connector, build type B with long connection pins for AB transfer and AB

shrouds are inserted into position rP2. At the rear card end, on position rJ2, a shielded female connector in build type AB is specified. For 6 HE backplanes, on P3 and P5, the male connector - build type B with long connection pins - for AB transfer and AB shrouds have to be inserted into positions rP3 and rP5. At the rear card end, on positions rJ3 and rJ5, a shielded female connector, build type AB, has been specified here. On P4, a blade contact strip, build type A with long connection pins for A shroud and A shroud frames, has been specified on position rP4. For the rear card end, a shielded female connector, build type A, has been defined on rJ4. For male connectors with shrouds in build types A and B, the specification only requires a series a grounding for the upper screening panel.

All necessary connectors required in accordance with the new CompactPCI specification are available from ERNI. In addition, for CompactPCI applications, ERNI also offers an economic solution for a male connector with long terminal pins, which is populated with shield contacts on row a only. In addition to the new AB compatible male connectors for CompactPCI, ERNI also supplies shrouds. Here, all shrouds are available in four different heights (3.9 mm, 4.5 mm, 5.3 mm, and 6.1 mm) in order to adapt to the printed circuit board thickness of the backplanes.

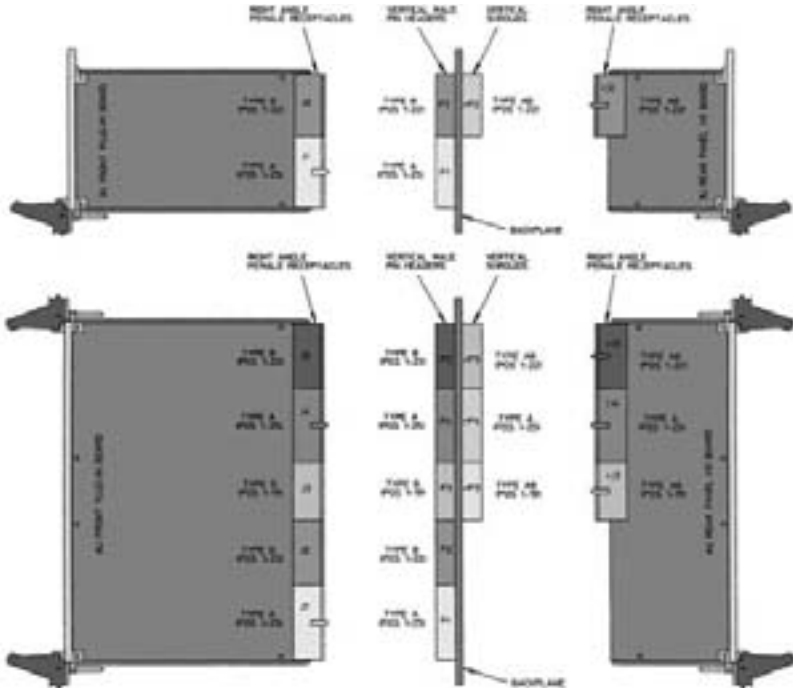

2.0 mm ERmet Hard Metric Connector System

CompactPCI Connectors acc. to PIGMG 2.0 Rev. 3.0



Ordering Informations

Male Connectors For Backplanes	Location On The PCB	Number Of Positions*	Contact Loading*	Part Number
Type A With Peg	P1	25	CB---BC	923190
Type A With Peg And Extended Terminals For Shrouding	P1 Special	25	TP---PT	923197
Type A Without Peg And With Extended Terminals For Shrouding	P1	25	TS---ST	923342
Type B (AB Compatible) With Extended Terminals For Shrouding	P2, P5	22	TSSSSS-	923345
Type B (AB Compatible) With Extended Terminals For Shrouding	P3	19	TSSSSST	923341
Type B (AB Compatible) With Extended Terminals For Shrouding	P3	19	TSSSSS-	923346
Type A With Extended Terminals For Shrouding	P4	25	S---ST	923347
Type A With Peg And Extended Terminals For Shrouding	P4	25	TRRRRT	064688
Type A With Peg And Extended Terminals For Shrouding	P4	25	TSSSSST	103975
Type A Without Peg	P4 Telecom	25	-----	923160
Type A Without Peg And With Extended Terminals For Shrouding	P4 Telecom	25	-----	923212
Type B (AB Compatible) With Extended Terminals For Shrouding	P5 Telecom	22	-----	923339
Type B (AB Compatible) With Extended Terminals For Shrouding	P2, P5	22	TSSSSST	923340

Female Connectors For Daughter Cards	Location On The PCB	Number Of Positions*	Part Number
Type A With Shield, Without Peg	J1, J4	25	064176
Type A With Split Shield, Partially Loaded	J4 Telecom	25	140512
Type A With Split Shield, Partially Loaded	rJ4 Telecom	25	104697
Type AB With Shield, Without Peg	rJ2, rJ5	22	114809
Type AB With Shield, Without Peg	rJ3	19	114810
Type B With Upper Shield	J2, J5	22	064785
Type B With Upper Shield	J3	19	064784

Shrouds For Male Connectors	Location On The PCB	Number Of Positions*	Height	Part Number
Type A Shroud 25 Positions	rP1, rP4	25	14.35	114436
Type A Shroud 25 Positions	rP1, rP4	25	14.95	054795
Type A Shroud 25 Positions	rP1, rP4	25	15.75	054794
Type A Shroud 25 Positions	rP1, rP4	25	16.55	054793
Type AB Shroud 22 Positions	rP2, rP5	22	14.95	114426
Type AB Shroud 22 Positions	rP2, rP5	22	15.75	114427
Type AB Shroud 22 Positions	rP2, rP5	22	16.55	114428
Type AB Shroud 19 Positions	rP3	19	14.35	114487
Type AB Shroud 19 Positions	rP3	19	14.95	114488
Type AB Shroud 19 Positions	rP3	19	15.75	114489
Type AB Shroud 19 Positions	rP3	19	16.55	114490

Coding Keys	Application	Code Number	Color	Part Number
Coding Keys For Male Connectors And Shrouds	5.0 Volts P1	1567	Brilliant Blue	043347
Coding Keys For Male Connectors And Shrouds	3.3 Volts P1	3456	Cadmium Yellow	043345
Coding Keys For Male Connectors And Shrouds	Telecom P4	1248	Strawberry Red	043350
Coding Keys For Female Connectors	5.0 Volts J1	2348	Brilliant Blue	043337
Coding Keys For Female Connectors	3.3 Volts P1	1278	Cadmium Yellow	043335
Coding Keys For Female Connectors	Telecom J4	3567	Strawberry Red	043340

* Length = 50mm Pitch = 2.0mm => 50 / 2 = 25 Positions

**Cross Sectional Loading From Z To F

Mouser Electronics

Authorized Distributor

Click to View Pricing, Inventory, Delivery & Lifecycle Information:

[ERNI Electronics:](#)

[114437](#) [114015](#) [104790](#) [064219](#) [114231](#) [064690](#) [220012](#) [064783](#) [220027](#) [220174](#) [220173](#)



Компания «ЭлектроПласт» предлагает заключение долгосрочных отношений при поставках импортных электронных компонентов на взаимовыгодных условиях!

Наши преимущества:

- Оперативные поставки широкого спектра электронных компонентов отечественного и импортного производства напрямую от производителей и с крупнейших мировых складов;
- Поставка более 17-ти миллионов наименований электронных компонентов;
- Поставка сложных, дефицитных, либо снятых с производства позиций;
- Оперативные сроки поставки под заказ (от 5 рабочих дней);
- Экспресс доставка в любую точку России;
- Техническая поддержка проекта, помощь в подборе аналогов, поставка прототипов;
- Система менеджмента качества сертифицирована по Международному стандарту ISO 9001;
- Лицензия ФСБ на осуществление работ с использованием сведений, составляющих государственную тайну;
- Поставка специализированных компонентов (Xilinx, Altera, Analog Devices, Intersil, Interpoint, Microsemi, Aeroflex, Peregrine, Syfer, Eurofarad, Texas Instrument, Miteq, Cobham, E2V, MA-COM, Hittite, Mini-Circuits, General Dynamics и др.);

Помимо этого, одним из направлений компании «ЭлектроПласт» является направление «Источники питания». Мы предлагаем Вам помощь Конструкторского отдела:

- Подбор оптимального решения, техническое обоснование при выборе компонента;
- Подбор аналогов;
- Консультации по применению компонента;
- Поставка образцов и прототипов;
- Техническая поддержка проекта;
- Защита от снятия компонента с производства.



Как с нами связаться

Телефон: 8 (812) 309 58 32 (многоканальный)

Факс: 8 (812) 320-02-42

Электронная почта: org@eplast1.ru

Адрес: 198099, г. Санкт-Петербург, ул. Калинина, дом 2, корпус 4, литера А.