



# MAX5391L/MAX5391N Evaluation Systems

## General Description

The MAX5391L and MAX5391N evaluation kits (EV kits) are fully assembled and tested PCBs that feature the MAX5391L (10k $\Omega$ ) and MAX5391N (100k $\Omega$ ) dual digital potentiometers, respectively. The MAX5391L/MAX5391N dual volatile potentiometers communicate through an SPI™-compatible 3-wire serial interface.

The MAX5391LEVMINIQU+ and MAX5391NEVMINIQU+ evaluation systems (EV systems) include the MAX5391L EV kit and MAX5391N EV kit, respectively, and a MINIUSB+ interface board. The MINIUSB+ interface board can be used to enable PC communication through the USB interface. Windows® 2000-, Windows XP®, and Windows Vista®-compatible software provides a professional user interface for exercising the MAX5391L/MAX5391N features. The program is menu-driven and offers a graphical user interface (GUI) complete with buttons, track bars, and edit boxes. The EV kit software can be used to evaluate the MAX5386M, MAX5393, and MAX5388. The EV kits can also be interfaced directly to a user-supplied 3-wire system.

The MAX5391L/MAX5391N ICs can be powered from a 1.7V, 2.6V, 3.3V, or 5V source generated from the MINIUSB+ interface board and EV kit circuitry, or a user-supplied external 1.7V to 5.25V DC power supply. Order the MAX5391LEVMINIQU+ or MAX5391NEVMINIQU+ EV system for a PC-based evaluation of the MAX5391L or MAX5391N, respectively.

The EV kits also contain PCB footprints for the MAX5386M, MAX5388, and MAX5393. To evaluate these parts, order samples and install the ICs on U1, U4, and U3, respectively.

SPI is a trademark of Motorola, Inc.

Windows, Windows XP, and Windows Vista are registered trademarks of Microsoft Corp.

## Features

- ◆ 1.7V to 5.25V Single-Supply Operation
- ◆ PC-USB to 3-Wire Interface or Stand-Alone 3-Wire Serial-Interface Operation
- ◆ Easy-to-Use Menu-Driven Software
- ◆ Includes Windows 2000-, Windows XP-, and Windows Vista-Compatible Software
- ◆ Fully Assembled and Tested

## Ordering Information

PART	TYPE
MAX5391LEVMINIQU+	EV System
MAX5391NEVMINIQU+	EV System

+Denotes lead(Pb)-free and RoHS compliant.

## Component Lists

### MAX5391L EV System (MAX5391LEVMINIQU+)

PART	QTY	DESCRIPTION
MAX5391LEVKIT+	1	EV kit
MINIUSB+	1	Maxim command module

### MAX5391N EV System (MAX5391NEVMINIQU+)

PART	QTY	DESCRIPTION
MAX5391NEVKIT+	1	EV kit
MINIUSB+	1	Maxim command module

### MAX5391L/MAX5391N EV Kits

DESIGNATION	QTY	DESCRIPTION
C1, C2, C3, C7, C10, C11, C14, C15, C19, C20, C23, C24, C25	13	1 $\mu$ F $\pm$ 10%, 16V X5R ceramic capacitors (0603) Murata GRM188R71C105K or TDK C1608X5R1C105K
C4, C8, C12, C16	4	0.1 $\mu$ F $\pm$ 10%, 50V X7R ceramic capacitors (0603) Murata GRM188R71H104K or TDK C1608X7R1H104K
C5, C6, C9, C13	0	Not installed, ceramic capacitors (0603)
C26	1	10 $\mu$ F $\pm$ 10%, 6.3V X5R ceramic capacitor (0805) Murata GRM21BR60J106K or TDK C2012X5R0J106K



# MAX5391L/MAX5391N Evaluation Systems

## Component Lists (continued)

### MAX5391L/MAX5391N EV Kits (continued)

DESIGNATION	QTY	DESCRIPTION
J1	1	2 x 4-pin header
J2	1	2 x 8-pin header
J3	1	8-pin female receptacle
JU1, JU3–JU6, JU8–JU18	16	2-pin headers
JU2, JU7, JU19	3	3-pin headers
JU20	1	4-pin header
R1	1	40.2kΩ ±1% resistor (0603)
R2	1	100kΩ ±1% resistor (0603)
U1	0	Not installed, dual digital potentiometer (16 TQFN-EP*)
U2	1	See the <i>EV Kit-Specific Component List</i>
U3	0	Not installed, digital potentiometer (14 TSSOP)
U4	0	Not installed, digital potentiometer (10 μMAX®)

DESIGNATION	QTY	DESCRIPTION
U5	1	Adjustable output LDO regulator (5 SC70) Maxim MAX8512EXK+ (Top Mark: ADW)
U6	1	2.6V LDO regulator (5 SC70) Maxim MAX8511EXK26+ (Top Mark: AAW)
U7	1	Single 1.8V to 5V level translator (6 SC70)
U8	1	Dual 1.8V to 5V level translator (8 SSOP)
—	20	Shunts (JU1–JU20)
—	1	PCB: MAX5386/5388/5391/5393 EVALUATION KIT+

\*EP = Exposed pad.

## EV Kit-Specific Component List

PART	DESIGNATION	DESCRIPTION
MAX5391LEVKIT+	U2	256-tap 10kΩ digital potentiometer (16 TQFN-EP*) Maxim MAX5391LATE+ (Top Mark: AHJ)
MAX5391NEVKIT+		256-tap 100kΩ digital potentiometer (16 TQFN-EP*) Maxim MAX5391NATE+ (Top Mark: AHL)

## Component Suppliers

SUPPLIER	PHONE	WEBSITE
Murata Electronics North America, Inc.	770-436-1300	www.murata-northamerica.com
TDK Corp.	847-803-6100	www.component.tdk.com

**Note:** Indicate that you are using the MAX5386M, MAX5388, MAX5391, or MAX5393 when contacting these component suppliers.

μMAX is a registered trademark of Maxim Integrated Products, Inc.

# MAX5391L/MAX5391N Evaluation Systems

## MAX5391L/MAX5391N EV Kit Files

FILE	DESCRIPTION
INSTALL.EXE	Installs the EV kit files on the computer
MAX5391L.EXE	Application programs
MAX5391N.EXE	
FTD2XX.INF	USB driver file
UNINST.INI	Uninstalls the EV kit software
USB_Driver_Help.PDF	USB driver installation help file

## Quick Start

### Required Equipment

- MAX5391L or MAX5391N EV system  
MAX5391L/MAX5391N EV kit  
MINIUSB+ command module (USB cable included)
- User-supplied Windows 2000, Windows XP, or Windows Vista PC with a spare USB port
- One or two multimeters

**Note:** In the following sections, software-related items are identified by bolding. Text in **bold** refers to items directly from the EV kit software. Text in **bold and underlined** refers to items from the Windows operating system.

### Procedure

The MAX5391L/MAX5391N EV kits are fully assembled and tested. Follow the steps below to verify board operation:

- 1) Visit [www.maxim-ic.com/evkitsoftware](http://www.maxim-ic.com/evkitsoftware) to download the latest version of the EV kit software, 5391\_Rxx.ZIP. Save the EV kit software to a temporary folder and uncompress the ZIP file.
- 2) Install the EV kit software on the computer by running the INSTALL.EXE program inside the temporary folder. The program files are copied and icons are created in the Windows **Start | Programs** menu.
- 3) Verify that shunts are correctly installed on the jumpers, as listed in Table 1, for proper operation of the EV kit.
- 4) Connect the multimeters to measure voltages across the MAX5391L/MAX5391N (U2) WA and LA PCB pads and WB and LB PCB pads.
- 5) Connect the MINIUSB+ interface board to the EV kit J2 and J3 connectors.
- 6) Connect the included USB cable from the PC to the MINIUSB+ interface board. A **Building Driver Database** window pops up in addition to a **New Hardware Found** message when installing the USB driver for the first time. If a window is not seen that is similar to the one described above after 30s, remove the USB cable from the board and reconnect it. Administrator privileges are required to install the USB device driver on Windows 2000, Windows XP, and Windows Vista.
- 7) Follow the directions of the **Add New Hardware Wizard** to install the USB device driver. Choose the **Search for the best driver for your device** option. Specify the location of the device driver to be **C:\Program Files\MAX5391L** or **C:\Program Files\MAX5391N** (default installation directory) using the **Browse** button. During device driver installation, Windows may show a warning message indicating that the device driver Maxim uses does not contain a digital signature. This is not an error condition and it is safe to proceed with installation. Refer to the USB\_Driver\_Help.PDF document included with the software if you have problems during this step.
- 8) Start the EV kit software by opening its icon in the **Start | Programs** menu.
- 9) Observe as the program automatically detects the USB connection and starts the main program.
- 10) Using the **Device Connected** combo box, select MAX5391 from the list and then press the **Default** button. The EV kit software main window appears, as shown in Figure 1.
- 11) The EV kit is now ready for additional testing.

Evaluate: MAX5386M/MAX5388/MAX5391/MAX5393

# MAX5391L/MAX5391N Evaluation Systems

**Table 1. Jumper Configuration for MAX5391L/MAX5391N EV Kit Operation**

JUMPER	SHUNT POSITION	EV KIT FUNCTION
JU1	Installed*	1.7V LDO output enabled
	Not installed	1.7V LDO output disabled
JU7	1-2*	MAX5391L/MAX5391N VDD voltage = 1.7V
	2-3	MAX5391L/MAX5391N VDD voltage dependent on jumper JU20 configuration
JU8	Not installed	MAX5391L/MAX5391N HA disconnected from the U2 VDD voltage source
	Installed*	MAX5391L/MAX5391N HA connected to the U2 VDD voltage source
JU9	Not installed	MAX5391L/MAX5391N LA disconnected from GND
	Installed*	MAX5391L/MAX5391N LA connected to GND
JU10	Not installed	MAX5391L/MAX5391N HB disconnected from the U2 VDD voltage source
	Installed*	MAX5391L/MAX5391N HB connected to the U2 VDD voltage source
JU11	Not installed	MAX5391L/MAX5391N LB disconnected from GND
	Installed*	MAX5391L/MAX5391N LB connected to GND
JU20	1-2	VPOWER = 5V
	1-3*	VPOWER = 3.3V
	1-4	VPOWER = 2.6V

\*Default position.

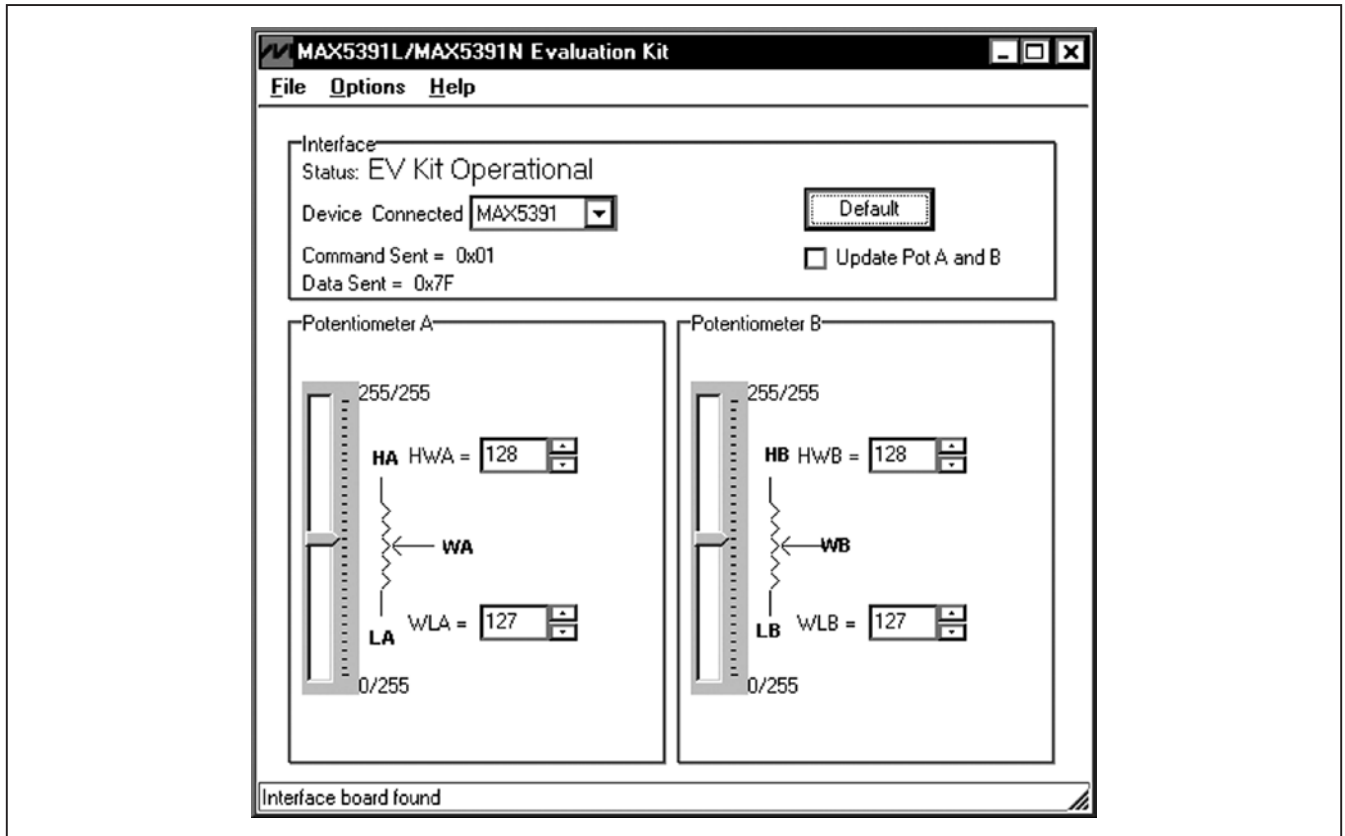

Figure 1. MAX5391L/MAX5391N Evaluation Kit Software Main Window

# MAX5391L/MAX5391N Evaluation Systems

## Detailed Description of Software

### Graphical User Interface (GUI) Panel

The EV kit software GUI shown in Figure 1 is a Windows program that provides a convenient means to control the MAX5391L and MAX5391N dual potentiometers. Use the mouse or press the Tab key to navigate through the GUI controls. The correct SPI write operations are generated to update the MAX5391L/MAX5391N internal memory registers when any of these controls are executed.

The software divides the EV kit functions into group boxes. The **Interface** group box indicates the EV kit **Status** and the last write operation **Command Sent** and **Data Sent** indicators. This data confirms proper device operation. The **Device Connected** combo box selects the Maxim part being evaluated and enables the **Update Pot A and B** checkbox function when choosing the MAX5391 option from the list. The **Default** button programs both potentiometers to their midscale positions. The lower **Potentiometer A** and **Potentiometer B** group boxes provide controls to change the respective wiper positions. The main window's bottom status bar provides the USB interface circuit communication status.

### Software Startup

Upon startup, the EV kit software automatically searches for the USB interface board's circuit connection. In the **Interface** group box, the **Device Connected** combo box allows the user to select the proper part being evaluated. Upon selection of the device being evaluated, the **Update Pot A and B** checkbox is enabled/disabled. The EV kit enters the normal operating mode when the USB connection is detected and the part has been selected. Since the MAX5391L/MAX5391N do not have read capability, all the edit boxes are set to question marks (??) and the **Potentiometer\_** track bars are set to midscale. If the USB connection is not detected, the software prompts the user to retry, exit the program, or enter the demo mode.

### Demo Mode

The EV kit software enters the demo mode, when the USB connection is not detected, by selecting **Cancel** on the **MAX5391L/MAX5391N Evaluation Kit Interface Circuit** pop-up window (Figure 2). The software can also enter demo mode at any time from the main window by selecting the **Options | Demo Mode** menu item. When in demo mode, all software communication to the EV kit circuit is disabled; however, most of the software GUI is functional. Demo mode allows the user to evaluate the software without hardware connectivity. To exit demo mode, deselect the **Options | Demo Mode** menu item.

### Potentiometer A and B Wiper Positions

The wiper position track bars (WA, WB) in the **Potentiometer A** and **Potentiometer B** group boxes are used to independently change the wiper position between the H\_ and L\_ end points. Use the computer mouse or arrow keys to move the wiper position between the 256 position points. The wiper position can also be changed by entering the desired integer value in the edit boxes, or by pressing the up or down arrows in the respective edit box. A change in the **W\_** wiper position track bars, or **HW\_/WL\_** edit boxes, writes to the registers and the wiper position is updated with the data sent. The wiper position is shown in the **HW\_** and **WL\_** edit boxes. The **HW\_** edit box shows the wiper position with respect to the potentiometer H\_ end point and the **WL\_** edit box shows the wiper position with respect to the potentiometer L\_ end point.

Potentiometers A and B can be updated simultaneously by checking the **Update Pot A and B** checkbox. When enabled, the **Potentiometer A** group box sends the same data to both digital potentiometers and enables control of both digital potentiometers together.

Evaluate: MAX5386M/MAX5388/MAX5391/MAX5393

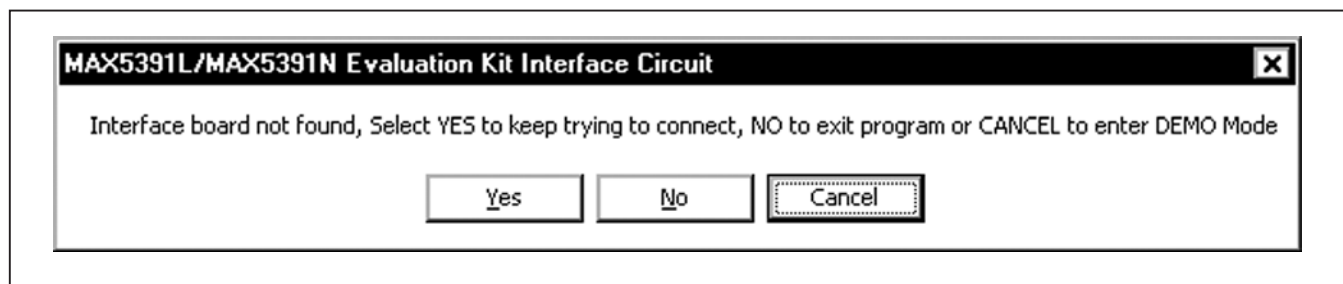

Figure 2. MAX5391L/MAX5391N Evaluation Kit Interface Circuit Pop-Up Window

# MAX5391L/MAX5391N Evaluation Systems

## Factory Default

Pressing the **Default** button resets potentiometer A and B wiper positions to the factory-default midscale position.

## Status Indicator

The **Status** indicator in the **Interface** group box displays **EV Kit Operational** when the EV kit enters the normal operating mode after the USB connection is detected. If the USB connection is not detected, or when the software enters the demo mode, the **Status** indicator displays **Demo Mode**. Demo mode is used to exercise the software without hardware connectivity.

## Command Sent Indicator

The **Command Sent** indicator in the **Interface** group box displays the last command sent from the master (software) to the MAX5391L/MAX5391N IC. There are three commands available in the MAX5391L/MAX5391N IC, which are listed in Table 2.

## Data Sent Indicator

The **Data Sent** indicator displays the last data sent for the write to potentiometer A (0x00), potentiometer B (0x01) or both potentiometer (0x03) commands. The MAX5391L/MAX5391N ICs use an 8-bit (MSBs, D7:0) data byte to set the wiper position. Refer to the MAX5391/MAX5393 IC data sheet for additional information.

## Keyboard Navigation

Press the Tab key to select each GUI control. The selected control is indicated by a dotted outline. Using Shift + Tab moves the selection to the previously selected control. Buttons respond to the keyboard's space bar and some controls respond to the keyboard's up and down arrow keys. Activate the program's menu bar by pressing the F10 key and then pressing the letter of the desired menu item. Most menu items have one letter underlined, indicating their shortcut key.

When a number is entered into the edit boxes, it is sent to the device by pressing the Enter key. It is also sent when Tab or Shift + Tab is pressed.

## Simple SPI Commands

There are two methods for communicating with the EV kit, through the normal user-interface panel (Figure 1), or through the SPI commands available by selecting the **3-Wire Interface** utility from the main program's **Options | Advanced Users Interface** menu bar. A window is displayed (Figure 3) that allows SPI send/receive data operations.

On the **3-wire interface** tab, the **Connection** group box defines the hardware connections of the interface. For the EV kit, **K10** is selected from the **Clock (SCK)(SCLK)** drop-down list, **K12** from the **Data from master to slave (MOSI)(DIN)** drop-down list, **K11** from the **Data from slave to master (MISO)(DOU)** drop-down list, **K9** from the **Chip-select (CS) for data framing** drop-down list, and the **Use standard connections for high-speed SPI** checkbox is checked (see Figure 3).

The **Configuration** group box allows the user to configure the logic level and data rate. For the EV kit, check the **Send & Receive MSB first** checkbox and verify that the **CPOL=1(clock idles high)** and **CPHA=1(sample 2nd edge)** checkboxes are unchecked (see Figure 3).

The **Send and Receive Data** group box allows the user to send data to the MAX5391L/MAX5391N. The **Data bytes to be written** edit box indicates data to be sent from the master (microcontroller) to the device (MAX5391L or MAX5391N). Eight-bit hexadecimal numbers should be comma delimited. Press the **Send Now** button to transmit the data from the master to the device. Data appearing in the **Data bytes received** edit box is data read from the device. The **Data bytes received** edit box in the EV kit software always shows a default value of **0xFF** since the MAX5391L/MAX5391N do not send data back to the master.

**Note:** The SPI dialog boxes accept numeric data in hexadecimal format. Hexadecimal numbers must be prefixed by \$ or 0x. Figure 3 shows a simple SPI write-byte operation using the included 3-wire interface diagnostics tool. In this example, the software is sending command 0x11 (write to potentiometers A and B) and data 0x7F. The data sequence sets potentiometer A and B wiper positions to 127.

# MAX5391L/MAX5391N Evaluation Systems

Evaluate: MAX5386M/MAX5388/MAX5391/MAX5393

Table 2. MAX5391L/MAX5391N SPI Command

MAX5391L/ MAX5391N REGISTER	COMMAND		DESCRIPTION
	BINARY	HEX	
VREGA	00000000	0x00	SPI data is written to potentiometer A. Wiper WA position updates with SPI data.
VREGB	00000001	0x01	SPI data is written to potentiometer B. Wiper WB position updates with SPI data.
VREGAB	00000011	0x03	SPI data is written to potentiometers A and B. Wipers WA and WB position updates with SPI data.

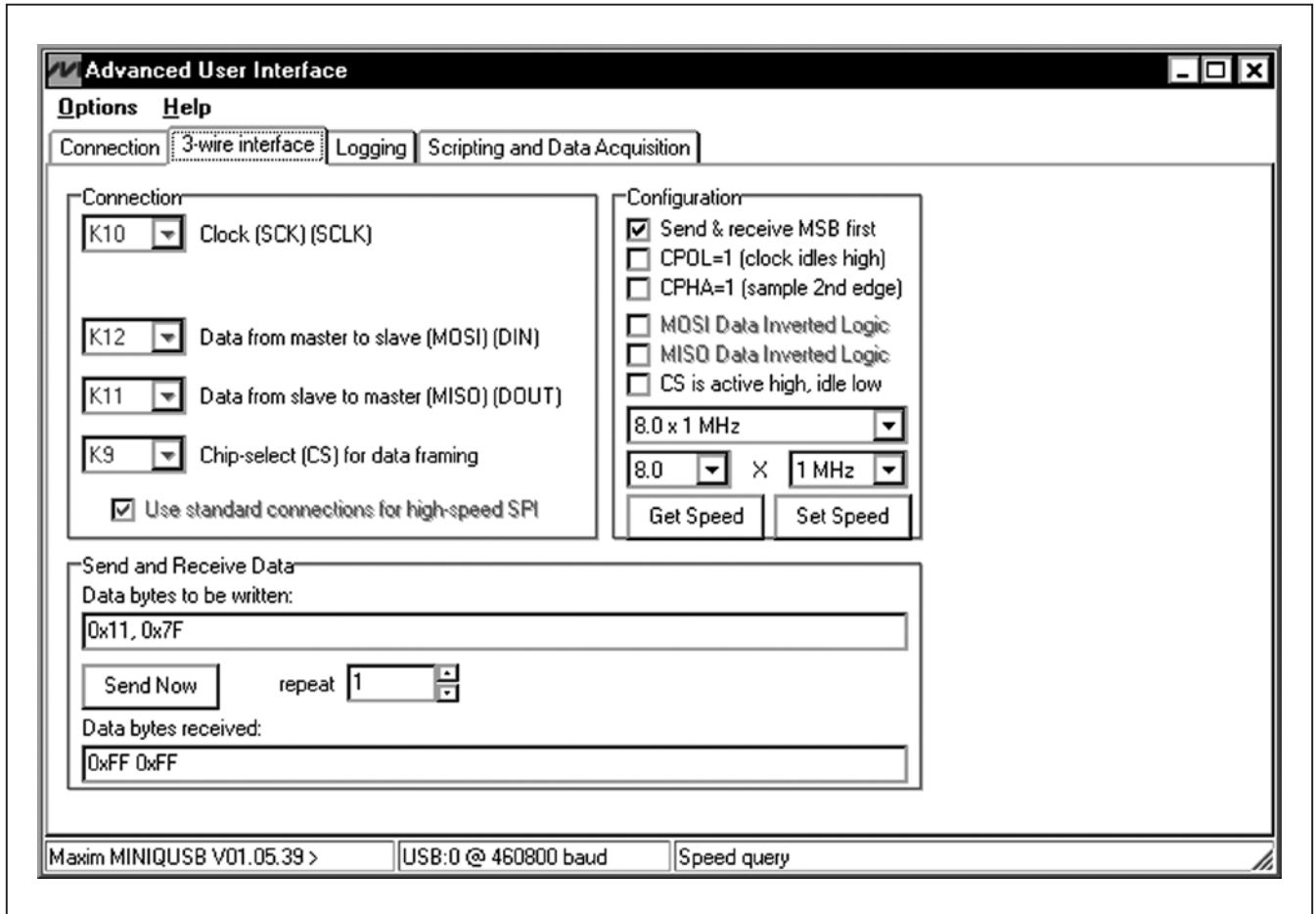

Figure 3. Simple Low-Level 3-Wire Interface

# MAX5391L/MAX5391N Evaluation Systems

## General Troubleshooting

### Problem: Software reports it cannot find the interface circuit

- Is the USB cable connected to the MINIQUSB+ board?
- Has Windows plug-and-play detected the board? Bring up **Control Panel->System->Device Manager**, and look at what device nodes are indicated for USB. If there is an **Unknown device node** attached to the USB, uninstall it—this forces plug-and-play to try again.
- If using an off-board SPI interface, is the power ground connected to the EV kit ground (GND) at one of the header J1 pin connections (J1-2, J1-4, J1-6, or J1-8)?

## Detailed Description of Hardware

The MAX5391L/MAX5391N EV kits are assembled and tested PCBs that feature the MAX5391L and MAX5391N dual digital potentiometers. Potentiometers A and B have an end-to-end resistance of 10kΩ (MAX5391L) and 100kΩ (MAX5391N). Each wiper can be programmed independently among 256 tap positions. Each EV kit uses a MAX5391L or MAX5391N IC in a 16-pin thin QFN package on a proven two-layer PCB design.

The EV kits provide connector J1 to interface with the MAX5391L/MAX5391N CS, DIN, SCLK, and GND signals directly to a user-supplied 3-wire system. Connector J1 also provides a connection for the EV kit's 1.7V to 5.5V VPOWER power-supply input.

**Table 3. VPOWER Rail (JU20)**

SHUNT POSITION	VPOWER RAIL
1-2	5V (MINIQUSB+ circuitry)
1-3	3.3V (MINIQUSB+ circuitry)
1-4	2.6V (LDO U6)
Not installed	External source applied at the EV kit VDD and GND PCB pads

**Note:** LDO U6 output is disabled when the MINIQUSB+ board is not installed at headers J2 and J3.

The EV kits are typically used with a MINIQUSB+ interface board for communicating with a PC through the 3-wire serial interface. Logic-level translators (U7 and U8) provide proper SPI interface translation when using 1.7V to 5.5V to power the MAX5391L/MAX5391N VDD input.

### EV Kit VDD Input Source

The VPOWER rail is typically supplied as 3.3V or 5V by the MINIQUSB+ interface board circuitry or 2.6V using LDO regulator U6. LDO regulator U5 output is set to 1.7V and is powered from the VPOWER rail. The VPOWER rail and U5 are used to set the MAX5391L/MAX5391N VDD input to 5V, 3.3V, 2.6V or 1.7V.

Regulator U5 has an adjustable output that can be configured to a different voltage by replacing resistor R1. Use the following equation to set U5 output voltage:

$$R1 = 10^5 \times \left( \frac{V_{OUT}}{1.225} - 1 \right)$$

where R1 is in ohms and VOUT is the desired U5 output voltage.

Jumper JU20 selects the source for each EV kit circuit VPOWER rail. See Table 3 for proper jumper configuration for setting VPOWER rail.

Alternatively, the EV kit's VDD PCB pad can be used to supply an external 1.7V to 5.25V to the circuit's VPOWER rail by removing the shunt at jumper JU20.

Jumper JU1 enables/disables LDO U5 output. Install a shunt across JU1 to enable U5 1.7V output. Remove the shunt at JU1 to disable U5 output. See Table 4 for proper jumper JU1 configuration.

**Table 4. U5 LDO Function (JU1)**

SHUNT POSITION	U5 1.7V OUTPUT
Installed*	Enabled
Not installed	Disabled

\*Default position.



# MAX5391L/MAX5391N Evaluation Systems

**Table 5. MAX5391L/MAX5391N VDD Power Source (JU7, JU1, JU20)**

SHUNT POSITION			MAX5391L/MAX5391N VDD PIN
JU7	JU1	JU20	
1-2*	Installed*	X	1.7V
1-2	Not installed	X	Not powered
2-3	X	1-2	5V
		1-3	3.3V
		1-4	2.6V
		Not installed	External source applied at the VDD and GND PCB pads

\*Default position.  
X = Don't care.

## MAX5391L/MAX5391N VDD Input Configuration

Jumper JU7 selects the power source for the MAX5391L/MAX5391N VDD input. Install a shunt across pins 1-2 of jumper JU7 to operate the IC extended VDD input power supply rail to 1.7V. Install a shunt across pins 2-3 to operate the IC VDD input from the VPOWER rail. See Table 5 for proper jumper configuration for the MAX5391L/MAX5391N VDD power-supply input.

## SPI Clock and Data-/Chip-Select Inputs

The MAX5391L/MAX5391N features a clock and data-/chip-select input pins for SPI-compatible communication to control the wiper position. The clock and data-/chip-select pins can be driven by the MINIQUSB+ interface circuit or the PCB header (J1), along with a user-supplied external SPI-compatible controller. An external SPI-compatible controller can be connected to  $\overline{CS}$  (J1-3), DIN (J1-5), SCLK (J1-7), and GND (J1-2, J1-4, J1-6, J1-8) on header J1 to communicate with the MAX5391L/MAX5391N IC. When using an external SPI-compatible controller, verify that the MINIQUSB+ interface board has been disconnected from the EV kit's J2 and J3 headers. See Table 6 for header J1 pin assignments.

## Potentiometer, Voltage-Divider or Variable Resistor, with Ground Reference

Each EV kit provides an option to configure the MAX5391L/MAX5391N as a potentiometer or voltage-divider, open ended or with ground reference, respectively. Use jumpers JU8 and JU9 for potentiometer A, and jumpers JU10 and JU11 for potentiometer B configurations. Tables 7 and 8 list jumper options for configuring potentiometers A and B, respectively.

The MAX5391L/MAX5391N can also be configured as a variable resistor by shorting the H<sub>-</sub> and W<sub>-</sub> pads together using a wire. When operating as a variable resistor, any power source connected to the H<sub>-</sub>, W<sub>-</sub>, or L<sub>-</sub> pads must be voltage and current limited to the maximum conditions stated in the MAX5391/MAX5393 IC data sheet.

**Note:** To test the device in resistor mode, the ohmmeter must be GND referenced to the MAX5391L/MAX5391N. This can be accomplished by connecting the L<sub>-</sub> pin to GND or the H<sub>-</sub> pin to U2 VDD. Resistance can then be measured between W<sub>-</sub> and L<sub>-</sub> or W<sub>-</sub> and H<sub>-</sub> PCB pads.

## Evaluating the MAX5386M/MAX5388/MAX5393 ICs

The MAX5391L and MAX5391N EV kits are populated with additional PCB footprints (U1, U4, and U3) and various jumpers to evaluate the MAX5386M, MAX5388, and MAX5393, respectively.

An additional MAX5391L/MAX5391N can be placed at U1 for evaluation. PCB pads C5 or C6 are available for the IC BYP input. Use ceramic capacitors less than 1 $\mu$ F at C5 or C6 for proper operation of the IC charge pump. Refer to the MAX5386M, MAX5388, or MAX5393 evaluation system data sheets for additional information when evaluating the MAX5386, MAX5388, or MAX5393 digital potentiometers.

**Table 6. Header J1 Pin Assignments**

PIN	SIGNAL
J1-1	VPOWER
J1-2, J1-4, J1-6, J1-8	GND
J1-3	$\overline{CS}$
J1-5	DIN
J1-7	SCLK

**Evaluate: MAX5386M/MAX5388/MAX5391/MAX5393**

# MAX5391L/MAX5391N Evaluation Systems

**Table 7. JU8 and JU9 Jumper Functions (Potentiometer A)**

SHUNT POSITION		HA PAD	LA PAD	MAX5391L/MAX5391N FUNCTION
JU8	JU9			
Not installed*	Not installed	Not connected	Not connected	Potentiometer open ended
	Installed*		Connected to GND	Potentiometer with GND reference
Installed	Not installed	Connected to U2 VDD	Not connected	Voltage-divider open ended
	Installed		Connected to GND	Voltage-divider with GND reference

\*Default position.

**Table 8. JU10 and J11 Jumper Functions (Potentiometer B)**

SHUNT POSITION		HB PAD	LB PAD	MAX5391L/MAX5391N FUNCTION
JU10	JU11			
Not installed*	Not installed	Not connected	Not connected	Potentiometer open ended
	Installed*		Connected to GND	Potentiometer with GND reference
Installed	Not installed	Connected to U2 VDD	Not connected	Voltage-divider open end
	Installed		Connected to GND	Voltage-divider with GND reference

\*Default position.

**Table 9. Jumper Configuration (JU1–JU20)**

JUMPER	SHUNT POSITION	EV KIT FUNCTION
JU1	Installed*	1.7V LDO output enabled
	Not installed	1.7V LDO output disabled
JU2	1-2	MAX5386M voltage = 1.7V
	2-3*	MAX5386M VDD voltage dependent on jumper JU20 configuration
JU3	Not installed	MAX5386M HA disconnected from the U1 VDD voltage source
	Installed*	MAX5386M HA connected to the U1 VDD voltage source
JU4	Not installed	MAX5386M LA disconnected from GND
	Installed*	MAX5386M LA connected to GND
JU5	Not installed	MAX5386M HB disconnected from the U1 VDD voltage source
	Installed*	MAX5386M HB connected to the U1 VDD voltage source
JU6	Not installed	MAX5386M LB disconnected from GND
	Installed*	MAX5386M LB connected to GND
JU7	1-2*	MAX5391L/MAX5391N VDD voltage = 1.7V
	2-3	MAX5391L/MAX5391N VDD voltage dependent on jumper JU20 configuration
JU8	Not installed	MAX5391L/MAX5391N HA disconnected from the U2 VDD voltage source
	Installed*	MAX5391L/MAX5391N HA connected to the U2 VDD voltage source
JU9	Not installed	MAX5391L/MAX5391N LA disconnected from GND
	Installed*	MAX5391L/MAX5391N LA connected to GND
JU10	Not installed	MAX5391L/MAX5391N HB disconnected from the U2 VDD voltage source
	Installed*	MAX5391L/MAX5391N HB connected to the U2 VDD voltage source
JU11	Not installed	MAX5391L/MAX5391N LB disconnected from GND
	Installed*	MAX5391L/MAX5391N LB connected to GND

# MAX5391L/MAX5391N Evaluation Systems

**Table 9. Jumper Configuration (JU1–JU20) (continued)**

JUMPER	SHUNT POSITION	EV KIT FUNCTION
JU12	Not installed	MAX5393 HA disconnected from the U3 VDD voltage source
	Installed*	MAX5393 HA connected to the U3 VDD voltage source
JU13	Not installed	MAX5393 LA disconnected from GND
	Installed*	MAX5393 LA connected to GND
JU14	Not installed	MAX5393 HB disconnected from the U3 VDD voltage source
	Installed*	MAX5393 HB connected to the U3 VDD voltage source
JU15	Not installed	MAX5393 LB disconnected from GND
	Installed*	MAX5393 LB connected to GND
JU16	Not installed	MAX5388 LA disconnected from GND
	Installed*	MAX5388 LA connected to GND
JU17	Not installed	MAX5388 HB disconnected from the U4 VDD voltage source
	Installed*	MAX5388 HB connected to the U4 VDD voltage source
JU18	Not installed	MAX5388 LB disconnected from GND
	Installed*	MAX5388 LB connected to GND
JU19	1-2	MAX5393 VDD voltage = 1.7V
	2-3*	MAX5393 VDD voltage dependent on jumper JU20 configuration
JU20	1-2	VPOWER = 5V
	1-3*	VPOWER = 3.3V
	1-4	VPOWER = 2.6V

\*Default position.

**Evaluate: MAX5386M/MAX5388/MAX5391/MAX5393**

# MAX5391L/MAX5391N Evaluation Systems

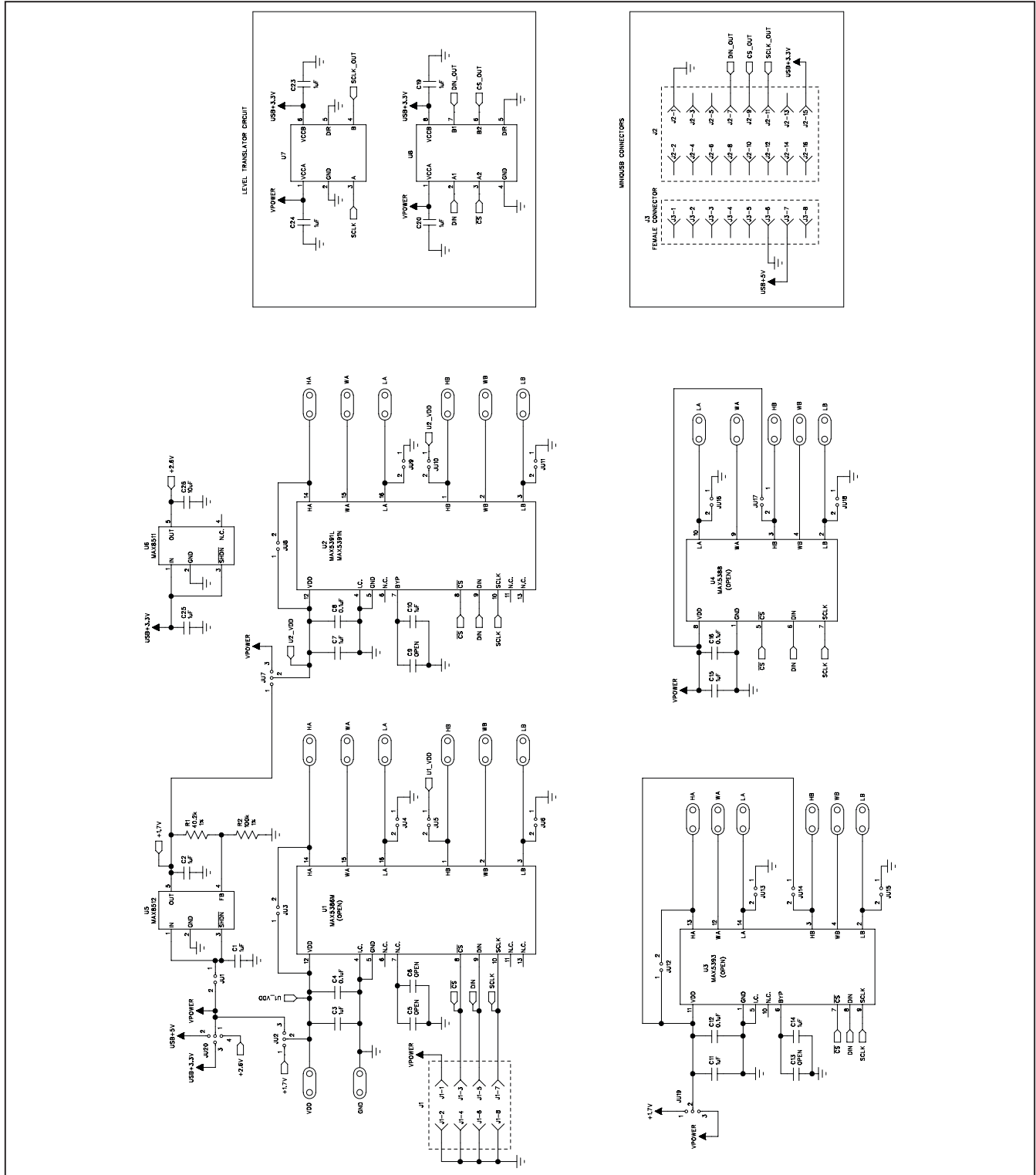

Figure 4. MAX5391L/MAX5391N EV Kit Schematic

# MAX5391L/MAX5391N Evaluation Systems

Evaluate: MAX5386M/MAX5388/MAX5391/MAX5393

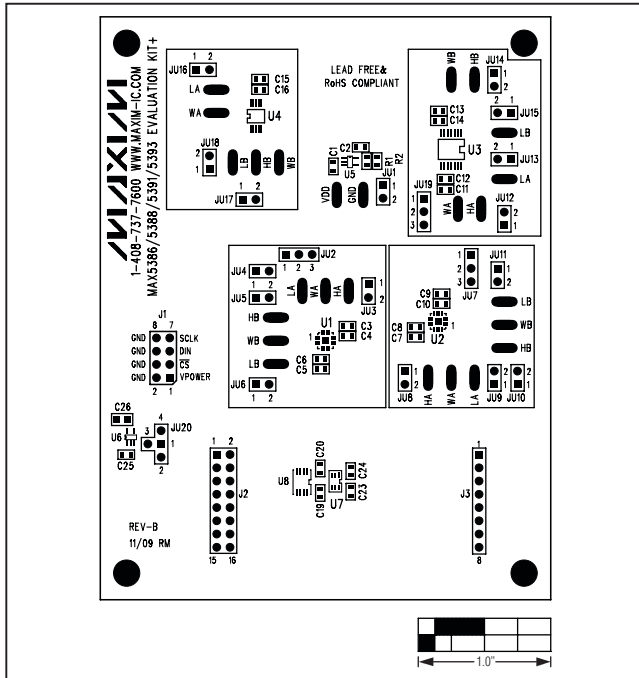

Figure 5. MAX5391L/MAX5391N EV Kit Component Placement Guide—Component Side

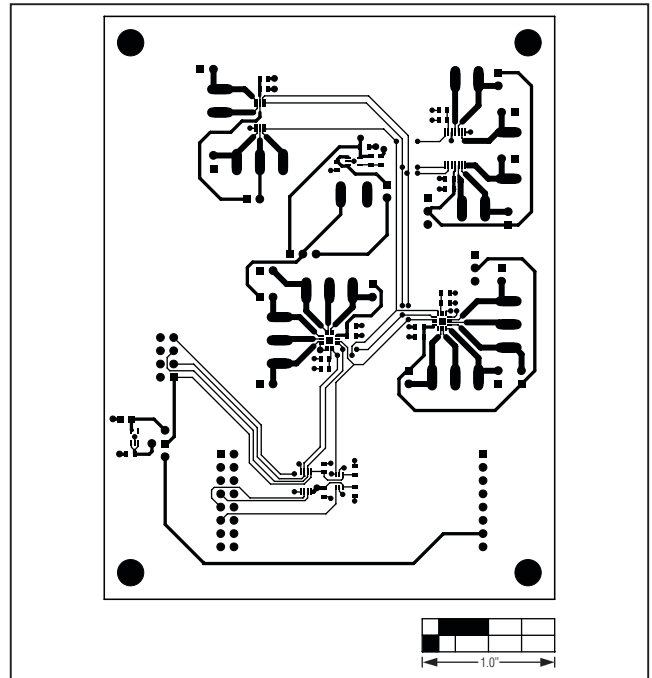

Figure 6. MAX5391L/MAX5391N EV Kit PCB Layout—Component Side

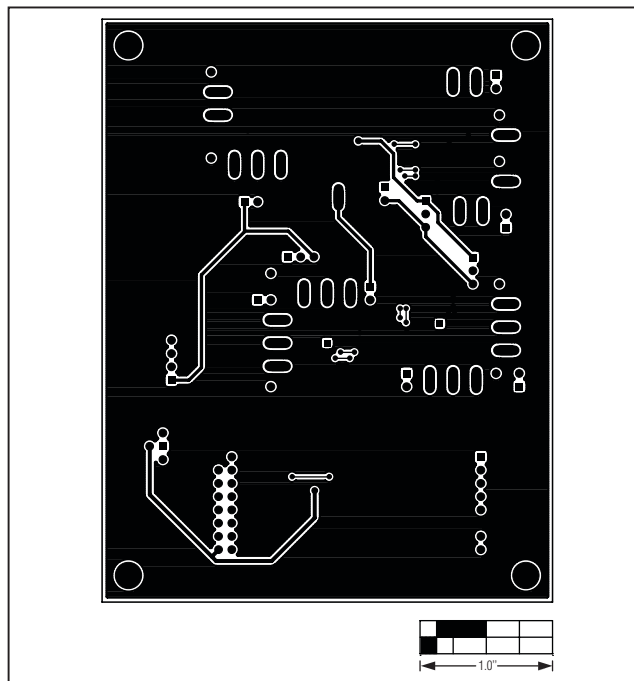

Figure 7. MAX5391L/MAX5391N EV Kit PCB Layout—Solder Side

Maxim cannot assume responsibility for use of any circuitry other than circuitry entirely embodied in a Maxim product. No circuit patent licenses are implied. Maxim reserves the right to change the circuitry and specifications without notice at any time.

Maxim Integrated Products, 120 San Gabriel Drive, Sunnyvale, CA 94086 408-737-7600 \_\_\_\_\_ 13



Компания «ЭлектроПласт» предлагает заключение долгосрочных отношений при поставках импортных электронных компонентов на взаимовыгодных условиях!

Наши преимущества:

- Оперативные поставки широкого спектра электронных компонентов отечественного и импортного производства напрямую от производителей и с крупнейших мировых складов;
- Поставка более 17-ти миллионов наименований электронных компонентов;
- Поставка сложных, дефицитных, либо снятых с производства позиций;
- Оперативные сроки поставки под заказ (от 5 рабочих дней);
- Экспресс доставка в любую точку России;
- Техническая поддержка проекта, помощь в подборе аналогов, поставка прототипов;
- Система менеджмента качества сертифицирована по Международному стандарту ISO 9001;
- Лицензия ФСБ на осуществление работ с использованием сведений, составляющих государственную тайну;
- Поставка специализированных компонентов (Xilinx, Altera, Analog Devices, Intersil, Interpoint, Microsemi, Aeroflex, Peregrine, Syfer, Eurofarad, Texas Instrument, Miteq, Cobham, E2V, MA-COM, Hittite, Mini-Circuits, General Dynamics и др.);

Помимо этого, одним из направлений компании «ЭлектроПласт» является направление «Источники питания». Мы предлагаем Вам помощь Конструкторского отдела:

- Подбор оптимального решения, техническое обоснование при выборе компонента;
- Подбор аналогов;
- Консультации по применению компонента;
- Поставка образцов и прототипов;
- Техническая поддержка проекта;
- Защита от снятия компонента с производства.



#### Как с нами связаться

**Телефон:** 8 (812) 309 58 32 (многоканальный)

**Факс:** 8 (812) 320-02-42

**Электронная почта:** [org@eplast1.ru](mailto:org@eplast1.ru)

**Адрес:** 198099, г. Санкт-Петербург, ул. Калинина, дом 2, корпус 4, литера А.