



M23 A Series



M23 B Series



M40 C Series



M23 Checkmate™ (A & B Series)



M23 Hybrid DMC Series

MotionGrade™ DIN Style Connectors



Standard products. Custom solutions.

© 2013 Amphenol Sine Systems Corporation. Every effort has been made to ensure that the information contained in this document is accurate at the time of publication. Specifications or information stated in this document are subject to change without notice.

Table of Contents

We Are Amphenol	1
Standard products. Custom solutions.	2
Product Overviews	3-4
Ordering Guide	5-9
Coding Key Chart	10
M23 A Series Overview	
Features & Benefits, Technical Specifications	11-12
Standard Products	13-18
M23 B Series Overview	
Features & Benefits, Technical Specifications	19-20
Standard Products	21-25
M23 Hybrid DMC Series Overview	
Features & Benefits, Technical Specifications	27-28
Standard Products	28
M40 C Series Overview	
Features & Benefits, Technical Specifications	29-30
Standard Products	31
Cord Grip & FlexGrip Backshell Options	33-34
Cable Prep & Assembly	35-36
Receptacle Assembly	37
Contacts & Tooling	39-40

We are Amphenol.

We are a global leader in providing you with world-class interconnection options and solutions.

We fulfill the needs of Industrial, Factory Automation, Heavy Duty, Automotive, Diagnostic and Custom-design markets.

Our engineers design innovative combinations of industry standard connectors and application specific shielding components to create assembly systems that set the standards for performance, reliability, and cost effectiveness. Our engineering, materials, and manufacturing organizations meet the high standards imposed by ISO 9001 as well as many customer specific quality systems. Our performance has earned us ship to stock and world class performance awards from many major OEMs.

We are one of the largest interconnect solution suppliers in the world and supplies a wide range of product solutions worldwide. Amphenol, and all our subsidiaries, design, manufacture and market electrical, electronic and fiber-optic connectors, interconnect systems and coaxial and specialty cable. Amphenol has a diversified presence in high growth markets including: Information Technology and Data Communications Equipment, Mobile Devices, Mobile Networks, Broadband Communication, Military and Commercial Aerospace, Industrial and Automotive.



Standard products. Custom solutions.

Our MotionGrade™ DIN Style Automation product lines, which include M23 "A", "B", Checkmate™, Hybrid DMC and M40 Series, have key placement in all areas of Automation. Based on our superior build quality, high-performance capabilities and having been developed to be compatible with all other existing standard products industry-wide, our MotionGrade™ DIN Style products are the perfect alternatives for you.

We can custom design, engineer and manufacture cable assemblies to your exact customer specifications and produce large or small quantities, all to the highest standards, delivered on-time and in-specification, all with a significant cost-savings over the competition.

By combining locally-based Program Management & Engineering, along with the associated cost advantages derived from manufacturing in our low-cost production centers in North America and Asia, our Team will work with you to design the most cost-efficient and reliable interconnect system available.



Product Overviews

Amphenol Sine Systems' MotionGrade™ M23 and M40 Connector Systems are designed to excel in performance and reliability in our customers' most demanding environments. Amphenol's MotionGrade™ M23 and M40 products are ideally suited for advanced servo drive encoder feedback applications, packaging, robotic, printing, machine tool, medical and automation environments where control signal transmission or power are required in a robust and compact delivery system.



M23 A Series See Pg. 11 12, 16 and 17 positions available

- 10A Max Current; 160V (12 pos), 125V (16-17 pos); 18-26AWG
- High-performance, cost-effective
- Superior environmental seal retention
- Compatible with existing standard products industry-wide



M23 B Series See Pg. 19 6, 8 and 9 positions available

- 30A Max Current; 630V Max Voltage; 14-16AWG
- High-performance, cost-effective
- Superior environmental seal retention
- Compatible with existing standard products industry-wide



M40 C Series See Pg. 29 6 and 8 positions available

- 75A Max Current; 630V Max Voltage; 8-12AWG
- High-performance, cost-effective
- Superior environmental seal retention
- Compatible with existing standard products industry-wide



M23 Checkmate™ See Pg. 11, 19

A Series: 12 and 17 positions available

B Series: 6, 8 and 9 positions available

- 10A Max Current; 160V (12 pos), 125V (17 pos); 14-20AWG
- NEWLY designed locking mechanism intermateable with other commercially available M23 quick-locking systems
- Vibration resistant, aerospace-style, MIL-38999 dual-ratcheting locking springs; IP-rated metal coupling system
- Distinctive alignment arrows with lock/unlock identifiers (ensures a solid connection every time)
- quarter-turn lock for quick-mating vs traditional threaded-style coupling



M23 Hybrid DMC Series See Pg. 27

2 Power + PE + 1 Signal + 4 Quad Element Ethernet

- 18A (2.0mm), 1A (1.0mm), 0.5A (Quad Element) Max Current
- 850V (2.0/1.0mm Contacts), 30VDC (Quad Element) Max. Volt.
- High-performance, cost-effective
- Superior environmental seal retention
- Ideally suited for advanced servo-drive encoder feedback applications where POWER, SIGNAL and COMMUNICATION is required in a robust and compact delivery system.

MotionGrade™ M23 A, B and C Series | Ordering Guide

Step 1-Choose Your Connector Type		Step 2- Choose Contact Type			Step 3-Choose Backend Hardware		
A Series	Description	Type	P/N Socket	P/N Pin	P/N Cord Grip	P/N Flex Grip	Mates with...
MA1CAE1200	M23, Str Plug, 12 Pos, E Type	Pin or Socket	SC000044(18-22) SC000030 (24-28)	SC000035(18-22) SC000146(24-28)	MA3CG-S(x) S1=4.5-7.5MM S2=7.5-11MM S3=11-15MM	1.MA4FSR-A8.5 2.MA4FSR-A10.5 3. MA4FSR-A12.8	MA1RAP1201 MA1LAP1200 MA1JAP1200
MA1CAP1200	M23, Str Plug, 12 Pos, P Type	Pin or Socket	SC000044(18-22) SC000030 (24-28)	SC000035(18-22) SC000146(24-28)	MA3CG-S(x) S1=4.5-7.5MM S2=7.5-11MM S3=11-15MM	1.MA4FSR-A8.5 2.MA4FSR-A10.5 3. MA4FSR-A12.8	MA1RAE1201 MA1LAE1200 MA1JAE1200
MA1CAE1600	M23, Str Plug, 16 Pos, E Type	Pin or Socket	SC000044(18-22) SC000030 (24-28)	SC000035(18-22) SC000146(24-28)	MA3CG-S(x) S1=4.5-7.5MM S2=7.5-11MM S3=11-15MM	1.MA4FSR-A8.5 2.MA4FSR-A10.5 3. MA4FSR-A12.8	MA1RAP1601 MA1LAP1600 MA1JAP1600
MA1CAP1600	M23, Str Plug, 16 Pos, P Type	Pin or Socket	SC000044(18-22) SC000030 (24-28)	SC000035(18-22) SC000146(24-28)	MA3CG-S(x) S1=4.5-7.5MM S2=7.5-11MM S3=11-15MM	1.MA4FSR-A8.5 2.MA4FSR-A10.5 3. MA4FSR-A12.8	MA1RAE1601 MA1LAE1600 MA1JAE1600
MA1CAE1700	M23, Str Plug, 17 Pos, E Type	Pin or Socket	SC000044(18-22) SC000030 (24-28)	SC000035(18-22) SC000146(24-28)	MA3CG-S(x) S1=4.5-7.5MM S2=7.5-11MM S3=11-15MM	1.MA4FSR-A8.5 2.MA4FSR-A10.5 3. MA4FSR-A12.8	MA1RAP1701 MA1LAP1700 MA1JAP1700
MA1CAP1700	M23, Str Plug, 17 Pos, P Type	Pin or Socket	SC000044(18-22) SC000030 (24-28)	SC000035(18-22) SC000146(24-28)	MA3CG-S(x) S1=4.5-7.5MM S2=7.5-11MM S3=11-15MM	1.MA4FSR-A8.5 2.MA4FSR-A10.5 3. MA4FSR-A12.8	MA1RAE1701 MA1LAE1700 MA1JAE1700
MA1EAE1200	M23, Rotatable 90° Plug, 12 Pos, E Type	Pin or Socket	SC000044(18-22) SC000030 (24-28)	SC000035(18-22) SC000146(24-28)	MA3CG-S(x) S1=4.5-7.5MM S2=7.5-11MM S3=11-15MM	1.MA4FSR-A8.5 2.MA4FSR-A10.5 3. MA4FSR-A12.8	MA1RAP1201 MA1LAP1200 MA1JAP1200
MA1EAP1200	M23, Rotatable 90° Plug, 12 Pos, P Type	Pin or Socket	SC000044(18-22) SC000030 (24-28)	SC000035(18-22) SC000146(24-28)	MA3CG-S(x) S1=4.5-7.5MM S2=7.5-11MM S3=11-15MM	1.MA4FSR-A8.5 2.MA4FSR-A10.5 3. MA4FSR-A12.8	MA1RAE1201 MA1LAE1200 MA1JAE1200
MA1EAE1600	M23, Rotatable 90° Plug, 16 Pos, E Type	Pin or Socket	SC000044(18-22) SC000030 (24-28)	SC000035(18-22) SC000146(24-28)	MA3CG-S(x) S1=4.5-7.5MM S2=7.5-11MM S3=11-15MM	1.MA4FSR-A8.5 2.MA4FSR-A10.5 3. MA4FSR-A12.8	MA1RAP1601 MA1LAP1600 MA1JAP1600
MA1EAP1600	M23, Rotatable 90° Plug, 16 Pos, P Type	Pin or Socket	SC000044(18-22) SC000030 (24-28)	SC000035(18-22) SC000146(24-28)	MA3CG-S(x) S1=4.5-7.5MM S2=7.5-11MM S3=11-15MM	1.MA4FSR-A8.5 2.MA4FSR-A10.5 3. MA4FSR-A12.8	MA1RAE1601 MA1LAE1600 MA1JAE1600
MA1EAE1700	M23, Rotatable 90° Plug, 17 Pos, E Type	Pin or Socket	SC000044(18-22) SC000030 (24-28)	SC000035(18-22) SC000146(24-28)	MA3CG-S(x) S1=4.5-7.5MM S2=7.5-11MM S3=11-15MM	1.MA4FSR-A8.5 2.MA4FSR-A10.5 3. MA4FSR-A12.8	MA1RAP1701 MA1LAP1700 MA1JAP1700
MA1EAP1700	M23, Rotatable 90° Plug, 17 Pos, P Type	Pin or Socket	SC000044(18-22) SC000030 (24-28)	SC000035(18-22) SC000146(24-28)	MA3CG-S(x) S1=4.5-7.5MM S2=7.5-11MM S3=11-15MM	1.MA4FSR-A8.5 2.MA4FSR-A10.5 3. MA4FSR-A12.8	MA1RAE1701 MA1LAE1700 MA1JAE1700
MA1LAE1200	M23, Str Recep., 12 Pos, E Type	Pin or Socket	SC000044(18-22) SC000030 (24-28)	SC000035(18-22) SC000146(24-28)	N/A	N/A	MA1CAP1200 MA1EAP1200
MA1LAP1200	M23, Str Recep., 12 Pos, P Type	Pin or Socket	SC000044(18-22) SC000030 (24-28)	SC000035(18-22) SC000146(24-28)	N/A	N/A	MA1CAE1200 MA1EAE1200

Step 1-Choose Your Connector Type		Step 2- Choose Contact Type			Step 3-Choose Backend Hardware		
A Series	Description	Type	P/N Socket	P/N Pin	P/N Cord Grip	P/N Flex Grip	Mates with...
MA1LAE1600	M23, Str Recep., 16 Pos, E Type	Pin or Socket	SC000044(18-22) SC000030 (24-28)	SC000035(18-22) SC000146(24-28)	N/A	N/A	MA1CAP1600 MA1EAP1600
MA1LAP1600	M23, Str Recep., 16 Pos, P Type	Pin or Socket	SC000044(18-22) SC000030 (24-28)	SC000035(18-22) SC000146(24-28)	N/A	N/A	MA1CAE1600 MA1EAE1600
MA1LAE1700	M23, Str Recep., 17 Pos, E Type	Pin or Socket	SC000044(18-22) SC000030 (24-28)	SC000035(18-22) SC000146(24-28)	N/A	N/A	MA1CAP1700 MA1EAP1700
MA1LAP1700	M23, Str Recep., 17 Pos, P Type	Pin or Socket	SC000044(18-22) SC000030 (24-28)	SC000035(18-22) SC000146(24-28)	N/A	N/A	MA1CAE1700 MA1EAE1700
MA1RAE1201	M23, Rotatable 90° Recep., 12 Pos, E Type	Pin or Socket	SC000044(18-22) SC000030 (24-28)	SC000035(18-22) SC000146(24-28)	N/A	N/A	MA1CAP1200 MA1EAP1200
MA1RAP1201	M23, Rotatable 90° Recep., 12 Pos, P Type	Pin or Socket	SC000044(18-22) SC000030 (24-28)	SC000035(18-22) SC000146(24-28)	N/A	N/A	MA1CAE1200 MA1EAE1200
MA1RAE1601	M23, Rotatable 90° Recep., 16 Pos, E Type	Pin or Socket	SC000044(18-22) SC000030 (24-28)	SC000035(18-22) SC000146(24-28)	N/A	N/A	MA1CAP1600 MA1EAP1600
MA1RAP1601	M23, Rotatable 90° Recep., 16 Pos, P Type	Pin or Socket	SC000044(18-22) SC000030 (24-28)	SC000035(18-22) SC000146(24-28)	N/A	N/A	MA1CAE1600 MA1EAE1600
MA1RAE1701	M23, Rotatable 90° Recep., 17 Pos, E Type	Pin or Socket	SC000044(18-22) SC000030 (24-28)	SC000035(18-22) SC000146(24-28)	N/A	N/A	MA1CAP1700 MA1EAP1700
MA1RAP1701	M23, Rotatable 90° Recep., 17 Pos, P Type	Pin or Socket	SC000044(18-22) SC000030 (24-28)	SC000035(18-22) SC000146(24-28)	N/A	N/A	MA1CAE1700 MA1EAE1700
MA1JAE1200	M23, Str Extension, 12 Pos, E Type	Pin or Socket	SC000044(18-22) SC000030 (24-28)	SC000035(18-22) SC000146(24-28)	MA3CG-S(x) S1=4.5-7.5MM S2=7.5-11MM S3=11-15MM	1.MA4FSR-A8.5 2.MA4FSR-A10.5 3. MA4FSR-A12.8	MA1CAP1200 MA1EAP1200
MA1JAP1200	M23, Str Extension, 12 Pos, P Type	Pin or Socket	SC000044(18-22) SC000030 (24-28)	SC000035(18-22) SC000146(24-28)	MA3CG-S(x) S1=4.5-7.5MM S2=7.5-11MM S3=11-15MM	1.MA4FSR-A8.5 2.MA4FSR-A10.5 3. MA4FSR-A12.8	MA1CAE1200 MA1EAE1200
MA1JAE1600	M23, Str Extension, 16 Pos, E Type	Pin or Socket	SC000044(18-22) SC000030 (24-28)	SC000035(18-22) SC000146(24-28)	MA3CG-S(x) S1=4.5-7.5MM S2=7.5-11MM S3=11-15MM	1.MA4FSR-A8.5 2.MA4FSR-A10.5 3. MA4FSR-A12.8	MA1CAP1600 MA1EAP1600
MA1JAP1600	M23, Str Extension, 16 Pos, P Type	Pin or Socket	SC000044(18-22) SC000030 (24-28)	SC000035(18-22) SC000146(24-28)	MA3CG-S(x) S1=4.5-7.5MM S2=7.5-11MM S3=11-15MM	1.MA4FSR-A8.5 2.MA4FSR-A10.5 3. MA4FSR-A12.8	MA1CAE1600 MA1EAE1600
MA1JAE1700	M23, Str Extension, 17 Pos, E Type	Pin or Socket	SC000044(18-22) SC000030 (24-28)	SC000035(18-22) SC000146(24-28)	MA3CG-S(x) S1=4.5-7.5MM S2=7.5-11MM S3=11-15MM	1.MA4FSR-A8.5 2.MA4FSR-A10.5 3. MA4FSR-A12.8	MA1CAP1700 MA1EAP1700

MotionGrade™ M23 A, B and C Series | Ordering Guide, cont.

NOTE: Type marked with (*) requires 2.0mm contacts, (**) requires 1.0 and 2.0mm contacts

Step 1-Choose Your Connector Type		Step 2- Choose Contact Type			Step 3-Choose Backend Hardware		
A Series	Description	Type	P/N Socket	P/N Pin	P/N Cord Grip	P/N Flex Grip	Mates with...
MA1JAP1700	M23, Str Extension, 17 Pos, P Type	Pin or Socket	SC000044(18-22) SC000030 (24-28)	SC000035(18-22) SC000146(24-28)	MA3CG-S(x) S1=4.5-7.5MM S2=7.5-11MM S3=11-15MM	1.MA4FSR-A8.5 2.MA4FSR-A10.5 3. MA4FSR-A12.8	MA1CAE1700 MA1EAE1700
MA3TNE1200-S(X)	M23,12 Position Panel Connector With Strain Relief, E Type	Pin or Socket	SC000044(18-22) SC000030 (24-28)	SC000035(18-22) SC000146(24-28)	S1=4.5-7.5MM S2=7.5-11MM S3=11-15MM	N/A	MA1CAP1200 MA1EAP1200
MA3TNP1200-S(X)	M23,12 Position Panel Connector With Strain Relief, P Type	Pin or Socket	SC000044(18-22) SC000030 (24-28)	SC000035(18-22) SC000146(24-28)	S1=4.5-7.5MM S2=7.5-11MM S3=11-15MM	N/A	MA1CAE1200 MA1EAE1200
MA3TNE1600-S(X)	M23,16 Position Panel Connector With Strain Relief, E Type	Pin or Socket	SC000044(18-22) SC000030 (24-28)	SC000035(18-22) SC000146(24-28)	S1=4.5-7.5MM S2=7.5-11MM S3=11-15MM	N/A	MA1CAP1600 MA1EAP1600
MA3TNP1600-S(X)	M23,16 Position Panel Connector With Strain Relief, P Type	Pin or Socket	SC000044(18-22) SC000030 (24-28)	SC000035(18-22) SC000146(24-28)	S1=4.5-7.5MM S2=7.5-11MM S3=11-15MM	N/A	MA1CAE1600 MA1EAE1600
MA3TNE1700-S(X)	M23,17 Position Panel Connector With Strain Relief, E Type	Pin or Socket	SC000044(18-22) SC000030 (24-28)	SC000035(18-22) SC000146(24-28)	S1=4.5-7.5MM S2=7.5-11MM S3=11-15MM	N/A	MA1CAP1700 MA1EAP1700
MA3TNP1700-S(X)	M23,17 Position Panel Connector With Strain Relief, P Type	Pin or Socket	SC000044(18-22) SC000030 (24-28)	SC000035(18-22) SC000146(24-28)	S1=4.5-7.5MM S2=7.5-11MM S3=11-15MM	N/A	MA1CAE1700 MA1EAE1700
Step 1-Choose your connector type		Step 2- Choose Contact Type			Step 3-Choose Backend Hardware		
B Series	Description	Type	P/N Socket or Pin (Refer to Type)		P/N Cord Grip	P/N Flex Grip	Mates with...
MB1CKN0600	M23, Str Plug, 6 Pos	Socket Only*	SC000045(2.0mm)(14-16)(6 Per)		MB3CG-S(x) S1=7.5-11MM S2=11-14.5MM S3=14.5-17MM	1.MB4FSR-B10.3 2.MB4FSR-B12.5 3. MB4FSR-B14.5 4. MB4FSR-B17	MB1LLN0600 MB1RJN0601 MB1JJN0600
MB1CKN0800	M23, Str Plug, 8 Pos	Socket Only**	SC000044(1.0mm)(18-22)(4Per) SC000030(1.0mm)(24-28)(4per) SC000045(2.0mm)(14-16)(4 Per)		MB3CG-S(x) S1=7.5-11MM S2=11-14.5MM S3=14.5-17MM	1.MB4FSR-B10.3 2.MB4FSR-B12.5 3. MB4FSR-B14.5 4. MB4FSR-B17	MB1LLN0800 MB1RJN0801 MB1JJN0800
MB1CKN0900	M23, Str Plug, 9 Pos	Socket Only**	SC000044(18-22)(1.0mm)(5Per) or SC000030(24-28)(1.0mm)(5Per) SC000045(14-16)(2.0mm)(4 Per)		MB3CG-S(x) S1=7.5-11MM S2=11-14.5MM S3=14.5-17MM	1.MB4FSR-B10.3 2.MB4FSR-B12.5 3. MB4FSR-B14.5 4. MB4FSR-B17	MB1LLN0900 MB1RJN0901 MB1JJN0900
MB1EJN0600	M23, Rotatable 90° Plug, 6 Pos	Socket Only*	SC000045(14-16)(2.0mm)(6 Per)		MB3CG-S(x) S1=7.5-11MM S2=11-14.5MM S3=14.5-17MM	1.MB4FSR-B10.3 2.MB4FSR-B12.5 3. MB4FSR-B14.5 4. MB4FSR-B17	MB1LLN0600 MB1RJN0601 MB1JJN0600
MB1EJN0800	M23, Rotatable 90° Plug, 8 Pos	Socket Only**	SC000044(18-22)(1.0mm)(4Per) or SC000030(24-28)(1.0mm)(4per) SC000045(14-16)(2.0mm)(4 Per)		MB3CG-S(x) S1=7.5-11MM S2=11-14.5MM S3=14.5-17MM	1.MB4FSR-B10.3 2.MB4FSR-B12.5 3. MB4FSR-B14.5 4. MB4FSR-B17	MB1LLN0800 MB1RJN0801 MB1JJN0800
MB1EJN0900	M23, Rotatable 90° Plug, 9 Pos	Socket Only**	SC000044(18-22)(1.0mm)(5Per) or SC000030(24-28)(1.0mm)(5per) SC000045(14-16)(2.0mm)(4 Per)		MB3CG-S(x) S1=7.5-11MM S2=11-14.5MM S3=14.5-17MM	1.MB4FSR-B10.3 2.MB4FSR-B12.5 3. MB4FSR-B14.5 4. MB4FSR-B17	MB1LLN0900 MB1RJN0901 MB1JJN0900
MB1LLN0600	M23, Str Recep., 6 Pos	Pin Only*	SC000036(14-16)(2.0mm)(6Per)		N/A	N/A	MB1CKN0600 MB1EJN0600
MB1LLN0800	M23, Str Recep., 8 Pos	Pin Only**	SC000035(18-22)(1.0mm)(4Per) SC000036(14-16)(2.0mm)(4 Per)		N/A	N/A	MB1CKN0600 MB1EJN0800

Step 1-Choose your connector type		Step 2- Choose Contact Type		Step 3-Choose Backend Hardware		
B Series	Description	Type	P/N Socket or Pin (Refer to Type)	P/N Cord Grip	P/N Flex Grip	Mates with...
MB1LLN0900	M23, Str, Recep., 9 Pos	Pin Only**	SC000035(18-22)(1.0mm)(5 Per) SC000036(14-16)(2.0mm)(4 Per)	N/A	N/A	MB1CKN0900 MB1EJN0900
MB1RJN0600	M23, Rotatable 90° Recep., 6 Pos	Pin Only*	SC000036 (14-16)(2.0mm)(6Per)	N/A	N/A	MB1CKN0600 MB1EJN0600
MB1RJN0800	M23, Rotatable 90° Recep., 8 Pos	Pin Only**	SC000035(18-22)(1.0mm)(4Per) SC000036(14-16)(2.0mm)(4 Per)	N/A	N/A	MB1CKN0800 MB1EJN0800
MB1RJN0900	M23, Rotatable 90° Recep., 9 Pos	Pin Only**	SC000035(18-22)(1.0mm)(5 Per) SC000036(14-16)(2.0mm)(4 Per)	N/A	N/A	MB1CKN0900 MB1EJN0900
MB1JJN0600	M23, Str Extension, 6 Pos	Pin Only*	SC000036 (14-16)(2.0mm)(6Per)	MB3CG-S(x) S1=7.5-11MM S2=11-14.5MM S3=14.5-17MM	1.MB4FSR-B10.3 2.MB4FSR-B12.5 3. MB4FSR-B14.5 4. MB4FSR-B17	MB1CKN0600 MB1EJN0600
MB1JJN0800	M23, Str Extension, 8 Pos	Pin Only**	SC000035(18-22)(1.0mm)(4Per) SC000036(14-16)(2.0mm)(4 Per)	MB3CG-S(x) S1=7.5-11MM S2=11-14.5MM S3=14.5-17MM	1.MB4FSR-B10.3 2.MB4FSR-B12.5 3. MB4FSR-B14.5 4. MB4FSR-B17	MB1CKN0800 MB1EJN0800
MB1JJN0900	M23, Str Extension, 9 Pos	Pin Only**	SC000035(18-22)(1.0mm)(5 Per) SC000036(14-16)(2.0mm)(4 Per)	MB3CG-S(x) S1=7.5-11MM S2=11-14.5MM S3=14.5-17MM	1.MB4FSR-B10.3 2.MB4FSR-B12.5 3. MB4FSR-B14.5 4. MB4FSR-B17	MB1CKN0900 MB1EJN0900
MB1GJN0600	M23, Female Panel Mount Conn, 6 Pos	Socket Only*	SC000045(14-16)(6 Per)	N/A	N/A	MB1JJN0600
MB1GJN0800	M23, Female Panel Mount Conn,8 Pos	Socket Only**	SC000044(18-22)(1.0mm)(4Per) or SC000030(24-28)(1.0mm)(4per) SC000045(2.0mm)(14-16)(4 Per)	N/A	N/A	MB1JJN0800
MB1GJN0900	M23, Female Panel Mount Conn, 9 Pos	Socket Only**	SC000044(18-22) (1.0mm)(5Per) or SC000030(24-28)(1.0mm)(5per) SC000045(2.0mm)(14-16)(4 Per)	N/A	N/A	MB1JJN0900
MB3TNN0600-S(X)	M23, Panel Connector With Strain Relief, 6 Pos	Pin Only*	SC000036(14-16)(6Per)	S1=7.5-11MM S2=11-14.5MM S3=14.5-17MM	N/A	MB1CKN0600 MB1EJN0600
MB3TNN0800-S(X)	M23, Panel Connector With Strain Relief, 8 Pos	Pin Only**	SC000035(18-22)(1.0mm)(4Per) SC000036(14-16)(2.0mm)(4 Per)	S1=7.5-11MM S2=11-14.5MM S3=14.5-17MM	N/A	MB1CKN0800 MB1EJN0800
MB3TNN0900-S(X)	M23, Panel Connector With Strain Relief, 9 Pos	Pin Only**	SC000035(18-22)(1.0mm)(5 Per) SC000036(14-16)(2.0mm)(4 Per)	S1=7.5-11MM S2=11-14.5MM S3=14.5-17MM	N/A	MB1CKN0900 MB1EJN0900
MB1LKN0600	M23, Jam Nut Recep., 6 Pos	Pin Only*	SC000036(14-16)(2.0mm)(6Per)	MB3CG-S(x) S1=7.5-11MM S2=11-14.5MM S3=14.5-17MM	1.MB4FSR-B10.3 2.MB4FSR-B12.5 3. MB4FSR-B14.5 4. MB4FSR-B17	MB1CKN0600 MB1EJN0600
MB1LKN0800	M23, Jam Nut Recep., 8 Pos	Pin Only**	SC000035(18-22)(1.0mm)(4Per) SC000036(14-16)(2.0mm)(4 Per)	MB3CG-S(x) S1=7.5-11MM S2=11-14.5MM S3=14.5-17MM	1.MB4FSR-B10.3 2.MB4FSR-B12.5 3. MB4FSR-B14.5 4. MB4FSR-B17	MB1CKN0800 MB1EJN0800
MB1LKN0900	M23, Jam Nut Recep., 9 Pos	Pin Only**	SC000035(18-22)(1.0mm)(5 Per) SC000036(14-16)(2.0mm)(4 Per)	MB3CG-S(x) S1=7.5-11MM S2=11-14.5MM S3=14.5-17MM	1.MB4FSR-B10.3 2.MB4FSR-B12.5 3. MB4FSR-B14.5 4. MB4FSR-B17	MB1CKN0900 MB1EJN0900

MotionGrade™ M23 A, B and C Series | Ordering Guide, cont.

NOTE: Type marked with (***) requires 2.0mm and 3.6mm contacts

Step 1-Choose your connector type		Step 2- Choose Contact Type		Step 3-Choose Backend Hardware		
M40 C SERIES	Description	Type	P/N Socket or Pin (Refer to Type)	P/N Cord Grip	P/N Flex Grip	Mates with...
MC1CJN0600	M40, Str Plug, 6 Pos	Socket Only***	SC000045(14-16)(2.0mm)(2Per) SC000046(8-12)(3.6mm)(4Per)	MC3CG-S(x) S1=9-12MM S2=12.5-14.5MM S3=14.5-17MM S4=17-19.5MM S5=19-21.5MM S6=21.5-24MM S7=25.5-26MM	MC4FSR-C18.5	MC1LKN0600 MC1NJN0600 MC1JJN0600
MC1CJN0800	M40, Str Plug, 8 Pos	Socket Only***	SC000045(14-16)(2.0mm)(4Per) SC000046(8-12)(3.6mm)(4Per)	MC3CG-S(x) S1=9-12MM S2=12.5-14.5MM S3=14.5-17MM S4=17-19.5MM S5=19-21.5MM S6=21.5-24MM S7=25.5-26MM	MC4FSR-C18.5	MC1LKN0800 MC1NJN0800 MC1JJN0800
MC1LKN0600	M40, Str Recep., 6 Pos	Pin Only***	SC000040(14-18)(2.0mm)(2Per) SC000041(8-12)(3.6mm)(4Per)	N/A	N/A	MC1CJN0600
MC1LKN0800	M40, Str Recep., 8 Pos	Pin Only***	SC000040(14-18)(2.0mm)(2Per) SC000041(8-12)(3.6mm)(4Per)	N/A	N/A	MC1CJN0800
MC1NJN0600	M40, Fixed 90° Recep., 6 Pos	Pin Only***	SC000040(14-18)(2.0mm)(2Per) SC000041(8-12)(3.6mm)(4Per)	N/A	N/A	MC1CJN0600
MC1NJN0800	M40, Fixed 90° Recep., 8 Pos	Pin Only***	SC000040(14-18)(2.0mm)(2Per) SC000041(8-12)(3.6mm)(4Per)	N/A	N/A	MC1CJN0800
MC1JJN0600	M40, Str Extension, 6 Pos	Pin Only***	SC000040(14-18)(2.0mm)(2Per) SC000041(8-12)(3.6mm)(4Per)	MC3CG-S(x) S1=9-12MM S2=12.5-14.5MM S3=14.5-17MM S4=17-19.5MM S5=19-21.5MM S6=21.5-24MM S7=25.5-26MM	MC4FSR-C18.5	MC1CJN0600
MC1JJN0800	M40, Str Extension, 8 Pos	Pin Only***	SC000040(14-18)(2.0mm)(2Per) SC000041(8-12)(3.6mm)(4Per)	MC3CG-S(x) S1=9-12MM S2=12.5-14.5MM S3=14.5-17MM S4=17-19.5MM S5=19-21.5MM S6=21.5-24MM S7=25.5-26MM	MC4FSR-C18.5	MC1CJN0800

MotionGrade™ M23 and M40 | Coding Key Chart

Insert Arrangements: A, B and C Series

Contact Size Legend		
		

M23 A Series (Face view: CW - clockwise, CCW - counter clockwise)

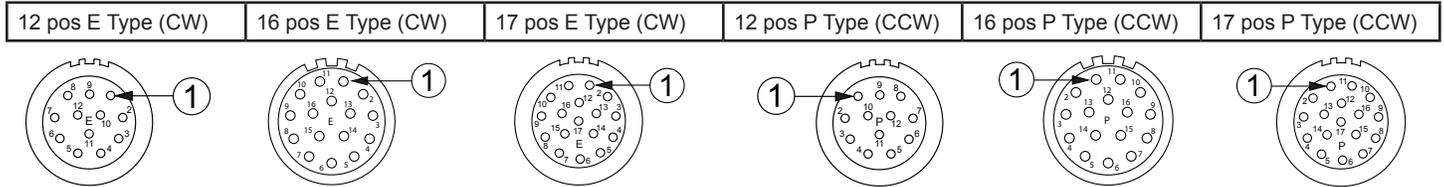

M23 B Series (Face view of socket insert)

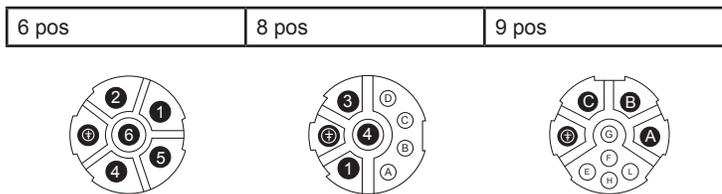

M40 C Series (Face view of socket insert)

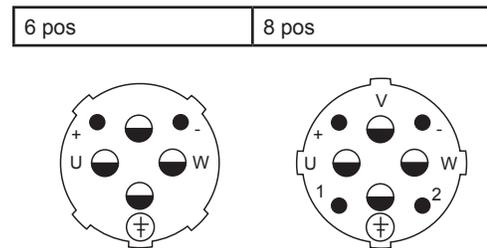

Coding Keys: M23 A Series Inserts Come with 3 Coding Keys.

NOTE: For interconnection, "F" mates with "S", "E" mates with "P" and "G" mates with "R".

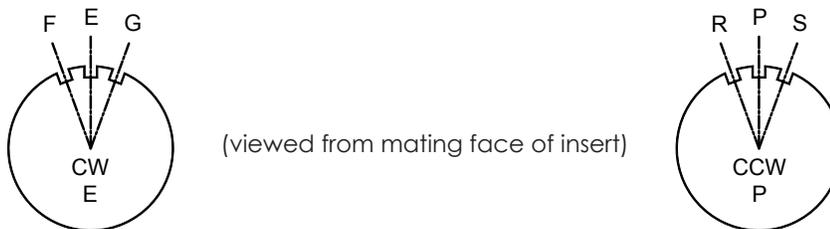

If you are ordering an "E" type connector, coding options are only: E, F & G.

Sample: MA1CA**E**1200 is "**E**" coding, MA1CA**F**1200 is "**F**" coding, MA1CA**G**1200 is "**G**" coding.
Standard coding is identified as "E".

If you are ordering a "P" type connector, coding options are only: P, R & S.

Sample: MA1CA**P**1200 is "**P**" coding, MA1CA**R**1200 is "**R**" coding, MA1CA**S**1200 is "**S**" coding.
Standard coding is identified as "P".

MotionGrade™ M23 A Series

Overview



Features & Benefits

Superior Shielding

First quality components coupled with a simplistic design provide maximum EMI/RFI shielding capabilities while reducing assembly preparation times.

Cable Strain Relief

Your choice of either the innovative design features of FlexGrip™ or traditional cable strain relieving similar to existing standard systems.

Fluid Resistance & Sealing

In combination with our strain relief systems, Amphenol utilizes advanced sealing technologies & materials to ensure highest reliability when subjected to the harshest environments.

RoHS Compliant

RoHS All materials meet the requirements of the European Directive 2002/95/EC, Issue 13.2.2003.

Approvals

ISO 9001/2000, UL & cUL Recognized, CYJV2/CYJV8 (12 Pos.), ECBT2/ECBT8 (16 & 17 Pos.)

Pending Approvals

VDE

Technical Specifications

Temperature Range	-20 to 130°C
Max. Current (AMP)	10A (12 Pos.), 9A (16, 17 Pos.)
Voltage Rating (AC/DC)	160V (12 Pos.), 125V (16, 17 Pos.)
Contact Resistance	< 15mΩ (12 Pos.), < 5mΩ (16, 17 Pos.)
Min. Mating Cycles	>50
Test Voltage Rating	2500V
Sealing Protection	IP66/67 (plugged condition)
Degree of Protection	3
Overvoltage Category	III
Strain Relief Clamp Range	4.5-15.0mm
Number of Contact (Size mm)	17 (0.6mm)
Wire Range (AWG)	18-30

Product Material

Housing Body	Zinc Die-cast
Coupling Nut	Nickel-plated
Insulation Inserts	PA66, UL94/V0
Contacts	Brass, Gold-plated
Sealing Material	DuPont Viton®

Dimensional Drawings

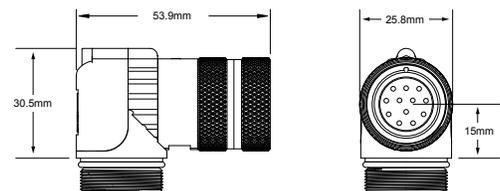
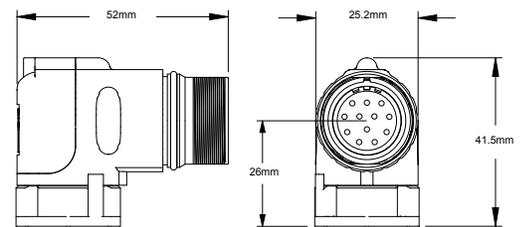
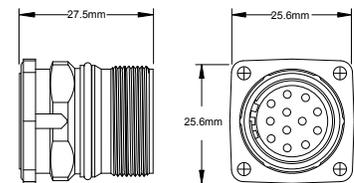
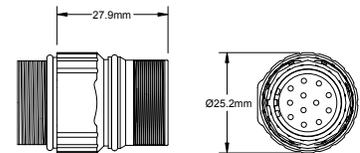
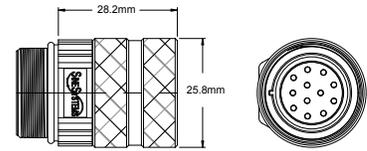

MotionGrade™ M23 A Series | Standard Products

All A Series plugs, receptacles and extensions accept pins or sockets. For keying options, please refer to Coding Key Chart on page 10. Contact your Sales Representative for more information.

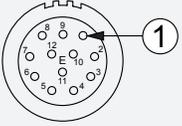
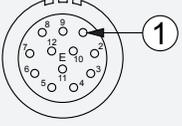
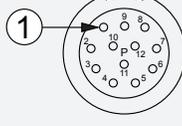
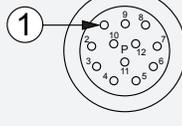
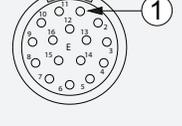
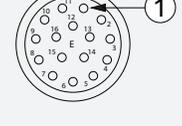
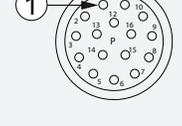
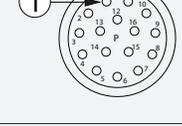
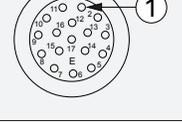
Part	Face View	Part Number	Description
		MA1CAE1200	M23, A Series, 12 pos., straight plug, E type, less contacts
		P30739-S(X)	 KIT: M23 Checkmate, A Series, straight plug, 12 pos., E Type, 1.0mm sockets. Options: -S1 (4.5-7.5mm) , -S2 (7.5-11mm) , -S3 (11-15mm)
		MA1CAP1200	M23, A Series, 12 pos., straight plug, P type, less contacts
		P30740-S(X)	 KIT: M23 Checkmate, A Series, straight plug, 12 pos., P Type, 1.0mm sockets. Options: -S1 (4.5-7.5mm) , -S2 (7.5-11mm) , -S3 (11-15mm)
		MA1CAE1600	M23, A Series, 16 pos., straight plug, E type, less contacts
		P30741-S(X)	 KIT: M23 Checkmate, A Series, straight plug, 16 pos., E Type, 1.0mm sockets. Options: -S1 (4.5-7.5mm) , -S2 (7.5-11mm) , -S3 (11-15mm)
		MA1CAP1600	M23, A Series, 16 pos., straight plug, P type, less contacts
		P30742-S(X)	 KIT: M23 Checkmate, A Series, straight plug, 16 pos., P Type, 1.0mm sockets. Options: -S1 (4.5-7.5mm) , -S2 (7.5-11mm) , -S3 (11-15mm)
		MA1CAE1700	M23, A Series, 17 pos., straight plug, E type, less contacts

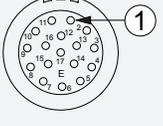
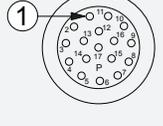
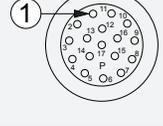
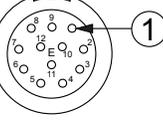
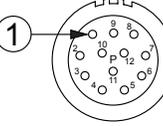
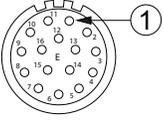
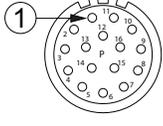
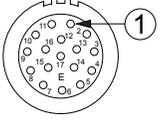
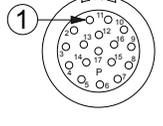
Part	Face View	Part Number	Description
		P30737-S(X)	CHECKMATE™ KIT: M23 Checkmate, A Series, straight plug, 17 pos., E Type, 1.0mm sockets. Options: -S1 (4.5-7.5mm) , -S2 (7.5-11mm) , -S3 (11-15mm)
		MA1CAP1700	M23, A Series, 17 pos., straight plug, P type, less contacts
		P30738-S(X)	CHECKMATE™ KIT: M23 Checkmate, A Series, straight plug, 17 pos., P Type, 1.0mm sockets. Options: -S1 (4.5-7.5mm) , -S2 (7.5-11mm) , -S3 (11-15mm)
		MA1EAE1200	M23, A Series, 12 pos., 90° rotatable plug, E type, less contacts
		MA1EAP1200	M23, A Series, 12 pos., 90° rotatable plug, P type, less contacts
		MA1EAE1600	M23, A Series, 16 pos., 90° rotatable plug, E type, less contacts
		MA1EAP1600	M23, A Series, 16 pos., 90° rotatable plug, P type, less contacts
		MA1EAE1700	M23, A Series, 17 pos., 90° rotatable plug, E type, less contacts
		MA1EAP1700	M23, A Series, 17 pos., 90° rotatable plug, P type, less contacts

MotionGrade™ M23 A Series | Standard Products, cont.

All A Series plugs, receptacles and extensions accept pins or sockets. For keying options, please refer to Coding Key Chart on page 10. Contact your Sales Representative for more information.

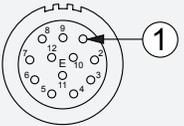
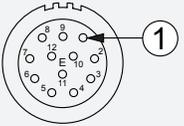
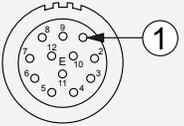
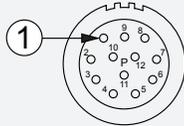
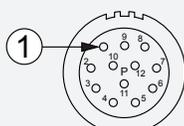
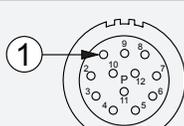
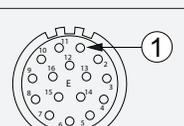
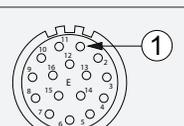
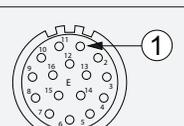
Part	Face View	Part Number	Description
		MA3TNE1200-S1	M23, A Series, 12 pos., panel connector with strain relief, E type, less contacts, cable diameter 4.5-7.5mm
		MA3TNE1200-S2	M23, A Series, 12 pos., panel connector with strain relief, E type, less contacts, cable diameter 7.5-11mm
		MA3TNE1200-S3	M23, A Series, 12 pos., panel connector with strain relief, E type, less contacts, cable diameter 11.0-15mm
		MA3TNP1200-S1	M23, A Series, 12 pos., panel connector with strain relief, P type, less contacts, cable diameter 4.5-7.5mm
		MA3TNP1200-S2	M23, A Series, 12 pos., panel connector with strain relief, P type, less contacts, cable diameter 7.5-11mm
		MA3TNP1200-S3	M23, A Series, 12 pos., panel connector with strain relief, P type, less contacts, cable diameter 11.0-15mm
		MA3TNE1600-S1	M23, A Series, 16 pos., panel connector with strain relief, E type, less contacts, cable diameter 4.5-7.5mm
		MA3TNE1600-S2	M23, A Series, 16 pos., panel connector with strain relief, E type, less contacts, cable diameter 7.5-11mm
		MA3TNE1600-S3	M23, A Series, 16 pos., panel connector with strain relief, E type, less contacts, cable diameter 11.0-15mm

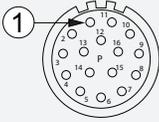
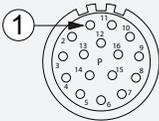
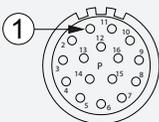
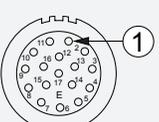
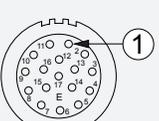
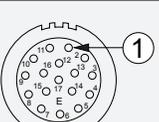
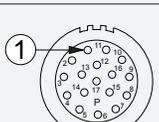
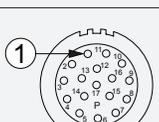
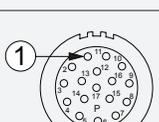
Part	Face View	Part Number	Description
		MA3TNP1600-S1	M23, A Series, 16 pos., panel connector with strain relief, P type, less contacts, cable diameter 4.5-7.5mm
		MA3TNP1600-S2	M23, A Series, 16 pos., panel connector with strain relief, P type, less contacts, cable diameter 7.5-11mm
		MA3TNP1600-S3	M23, A Series, 16 pos., panel connector with strain relief, P type, less contacts, cable diameter 11.0-15mm
		MA3TNE1700-S1	M23, A Series, 17 pos., panel connector with strain relief, E type, less contacts, cable diameter 4.5-7.5mm
		MA3TNE1700-S2	M23, A Series, 17 pos., panel connector with strain relief, E type, less contacts, cable diameter 7.5-11mm
		MA3TNE1700-S3	M23, A Series, 17 pos., panel connector with strain relief, E type, less contacts, cable diameter 11.0-15mm
		MA3TNP1700-S1	M23, A Series, 17 pos., panel connector with strain relief, P type, less contacts, cable diameter 4.5-7.5mm
		MA3TNP1700-S2	M23, A Series, 17 pos., panel connector with strain relief, P type, less contacts, cable diameter 7.5-11mm
		MA3TNP1700-S3	M23, A Series, 17 pos., panel connector with strain relief, P type, less contacts, cable diameter 11.0-15mm

MotionGrade™ M23 A Series | Standard Products, cont.

All A Series plugs, receptacles and extensions accept pins or sockets. For keying options, please refer to Coding Key Chart on page 10. Contact your Sales Representative for more information.

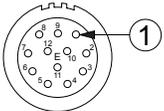
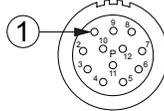
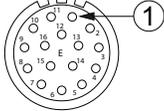
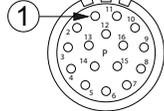
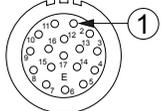
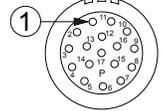
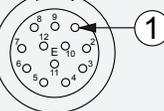
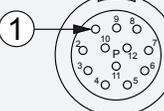
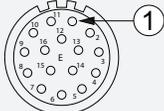
Part	Face View	Part Number	Description
		MA1LAE1200	M23, A Series, 12 pos., straight receptacle, flange mount, E type, less contacts
		MA1LAP1200	M23 A Series, 12 pos., straight receptacle, flange mount, P type, less contacts
		MA1LAE1600	M23, A Series, 16 pos., straight receptacle, flange mount, E type, less contacts
		MA1LAP1600	M23, A Series, 16 pos., straight receptacle, flange mount, P type, less contacts
		MA1LAE1700	M23, A Series, 17 pos., straight receptacle, flange mount, E type, less contacts
		MA1LAP1700	M23, A Series, 17 pos., straight receptacle, flange mount, P type, less contacts
		MA1RAE1201	M23, A Series, 12 pos., 90° rotatable receptacle, flange mount, E type, less contacts
		MA1RAP1201	M23, A Series, 12 pos., 90° rotatable receptacle, flange mount, P type, less contacts
		MA1RAE1601	M23, A Series, 16 pos., 90° rotatable receptacle, flange mount, E type, less contacts

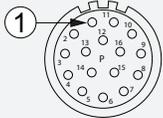
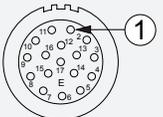
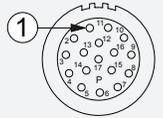
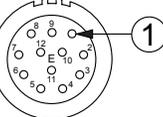
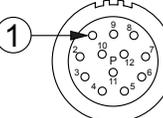
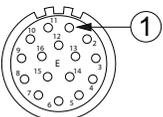
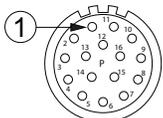
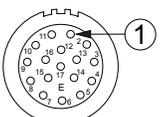
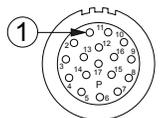
Part	Face View	Part Number	Description
		MA1RAP1601	M23, A Series, 16 pos., 90° rotatable receptacle, flange mount, P type, less contacts
		MA1RAE1701	M23, A Series, 17 pos., 90° rotatable receptacle, flange mount, E type, less contacts
		MA1RAP1701	M23, A Series, 17 pos., 90° rotatable receptacle, flange mount, P type, less contacts.
		MA1JAE1200	M23, A Series, 12 pos., straight extension connector, E type, less contacts
		MA1JAP1200	M23, A Series, 12 pos., straight extension connector, P type, less contacts
		MA1JAE1600	M23, A Series, 16 pos., straight extension connector, E type, less contacts
		MA1JAP1600	M23, A Series, 16 pos., straight extension connector, P type, less contacts
		MA1JAE1700	M23, A Series, 17 pos., straight extension connector, E type, less contacts
		MA1JAP1700	M23, A Series, 17 pos., straight extension connector, P type, less contacts

MotionGrade™ M23 B Series

Overview



Features & Benefits

Superior Shielding	First quality components coupled with a simplistic design provide maximum EMI/RFI shielding capabilities while reducing assembly preparation times.
Cable Strain Relief	Your choice of either the innovative design features of FlexGrip™ or traditional cable strain relieving similar to existing standard systems.
Fluid Resistance & Sealing	In combination with our strain relief systems, Amphenol utilizes advanced sealing technologies & materials to ensure highest reliability when subjected to the harshest environments.
RoHS Compliant	RoHS All materials meet the requirements of the European Directive 2002/95/EC, Issue 13.2.2003.
Approvals	ISO 9001/2000, E316693 Recognized (8 Pos.), E224856 Listed (6, 9 Pos.)
Pending Approvals	VDE

Technical Specifications

Temperature Range	-20 to 130°C
Max. Current (AMP)	28A (6 Pos. Power), 30A (8, 9 Pos. Power) 10A (8, 9 Pos. Signal)
Voltage Rating (AC/DC)	630V (6, 8, 9 Pos. Power), 250V (8, 9 Pos. Signal)
Contact Resistance	< 3mΩ (6, 8, 9 Pos. Power), < 5mΩ (8, 9 Pos. Signal)
Min. Mating Cycles	> 50
Test Voltage Rating	6000V (6, 8, 9 Pos. Power), 2500V (8, 9 Pos. Signal)
Sealing Protection	IP66/67 (plugged condition)
Protective Grounding	Per VDE 0627
Safety Protection	Per VDE 0623
Degree of Protection	3
Overvoltage Category	III
Strain Relief Clamp Range	7.5-17mm
Number of Contact (mm)	6 Pos: 6 Power 8 Pos: 4 Power (2.0mm) + 4 Signal (1.0mm) 9 Pos: 4 Power (2.0mm) + 5 Signal (1.0mm)
Wire Range (AWG)	14-18, 18-22
Product Material	
Housing Body	Zinc Die-cast
Coupling Nut	Nickel-plate
Insulation Inserts	PA66, UL94/V0
Contacts	Brass, Gold-plated
Sealing Material	DuPont Viton®

Dimensional Drawings

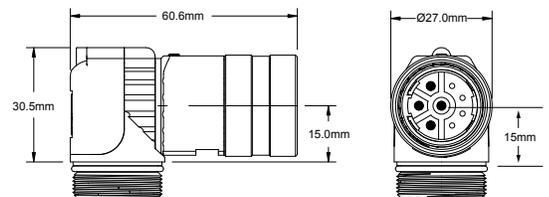
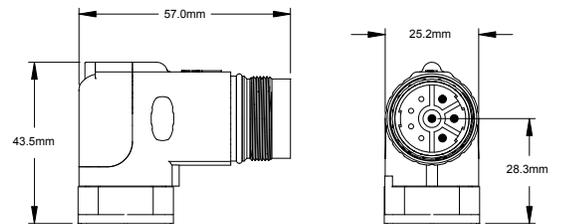
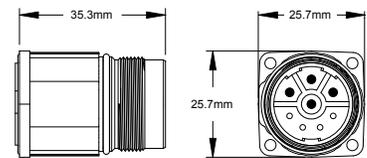
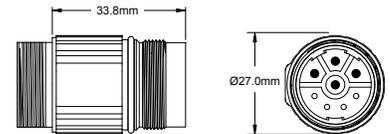
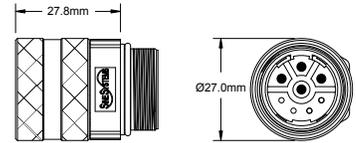

MotionGrade™ M23 B Series | Standard Products

Below are a listing of all available M23 B Series standard products. Contact your Sales Representative for more information.

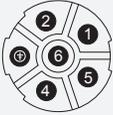
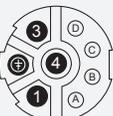
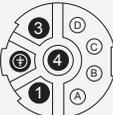
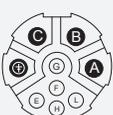
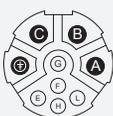
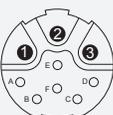
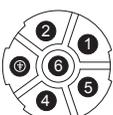
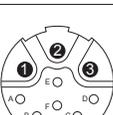
Part	Face View	Part Number	Description
		MB1CKN0600	M23, B Series, 6 pos., straight plug, less contacts.
		P30745-S(X)	 KIT: M23 Checkmate, B Series, 6 pos., 2.0mm sockets Options: -S1 (7.0-11.0mm) , -S2 (11.0-14.5mm) , -S3 (14.5-17.0mm)
		MB1CKN0800	M23, B Series, 8 pos. (4+4), straight plug, less contacts.
		P30744-S(X)	 KIT: M23 Checkmate, B Series, 8 pos., 2.0mm sockets Options: -S1 (7.0-11.0mm) , -S2 (11.0-14.5mm) , -S3 (14.5-17.0mm)
		MB1CKN0900	M23, B Series, 9 pos. (4+5), straight plug, less contacts.
		P30743-S(X)	 KIT: M23 Checkmate, B Series, 9 pos., 2.0mm sockets Options: -S1 (7.0-11.0mm) , -S2 (11.0-14.5mm) , -S3 (14.5-17.0mm)
		MB1CKNNG36	M23, B Series, 9 pos. (3+6), straight plug, less contacts. (Will accept up to 12AWG wire on the power.)
		MB1EJN0600	M23, B Series, 6 pos., 90°, rotatable plug, less contacts.
		MB1EJN0800	M23, B Series, 8 pos. (4+4), 90°, rotatable plug, less contacts
		MB1EJNNG36	M23, B Series, 9 pos. (3+6), 90° rotatable plug, less contacts. (Will accept up to 12AWG wire on the power.)

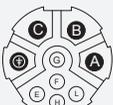
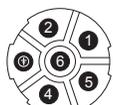
Part	Face View	Part Number	Description
		MB1EJN0900	M23, B Series, 9 pos. (4+5), 90°, rotatable plug, less contacts
		MB1GJN0600	M23, B Series, 6 pos., panel mount connector, female thread, less contacts.
		MB1GJN0800	M23, B Series, 8 pos. (4+4), panel mount connector, female thread, less contacts.
		MB1GJN0900	M23, B Series, 9 pos. (4+5), panel mount connector, female thread, less contacts.
		MB3TNN0600-S1	M23, B Series, 6 pos., panel connector with strain relief, male thread, less contacts, cable diameter 7.5-11mm
		MB3TNN0600-S2	M23, B Series, 6 pos., panel connector with strain relief, male thread, less contacts, cable diameter 11-15mm
		MB3TNN0600-S3	M23, B Series, 6 pos., panel connector with strain relief, male thread, less contacts, cable diameter 14.5-17mm
		MB3TNN0800-S1	M23, B Series, 8 pos.(4+4), panel connector with strain relief, male thread, less contacts, cable diameter 7.5-11mm
		MB3TNN0800-S2	M23, B Series, 8 pos.(4+4), panel connector with strain relief, male thread, less contacts, cable diameter 11-14.5mm

MotionGrade™ M23 B Series | Standard Products, cont.

Below are a listing of all available M23 B Series standard products. Contact your Sales Representative for more information.

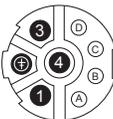
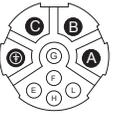
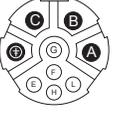
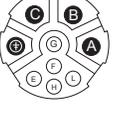
Part	Face View	Part Number	Description
		MB3TNN0800-S3	M23, B Series, 8 position (4+4), panel connector with strain relief, male thread, less contacts, cable diameter 14.5-17mm
		MB3TNN0900-S1	M23, B Series, 9 position (4+5), panel connector with strain relief, male thread, less contacts, cable diameter 7.5-11mm
		MB3TNN0900-S2	M23, B Series, 9 position (4+5), panel connector with strain relief, male thread, less contacts, cable diameter 11-14.5mm
		MB3TNN0900-S3	M23, B Series, 9 position (4+5), panel connector with strain relief, male thread, less contacts, cable diameter 14.5-17mm
		MB1LKN0600	M23, B Series, 6 position, jam nut receptacle, less contacts
		MB1LKN0800	M23, B Series, 8 position (4+4), jam nut receptacle, less contacts
		MB1LKN0900	M23, B Series, 9 position (4+5), jam nut receptacle, less contacts

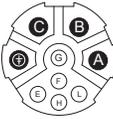
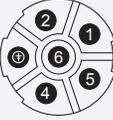
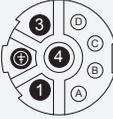
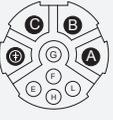
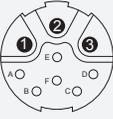
Part	Face View	Part Number	Description
		MB1JJN0600	M23, B Series, 6 position, straight extension connector, less contacts.
		MB1JJN0800	M23, B Series, 8 position (4+4), straight extension connector, less contacts.
		MB1JJN0900	M23, B Series, 9 position (4+5), straight extension connector, less contacts
		MB1LLN0600	M23, B Series, 6 position, straight receptacle, flange mount, less contacts
		MB1LLN0800	M23, B Series, 8 position (4+4), straight receptacle, flange mount, less contacts
		MB1LLN0900	M23, B Series, 9 position(4+5), straight receptacle, flange mount, less contacts
		MB1LLNNG36	M23, B Series, 9 position (3+6), straight receptacle, flange mount, less contacts (Will accept 12AWG wire on the power)

MotionGrade™ M23 B Series | **Standard Products**, cont.

Below are a listing of all available M23 B Series standard products. Contact your Sales Representative for more information.

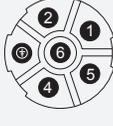
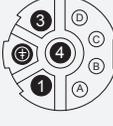
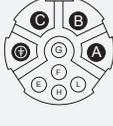
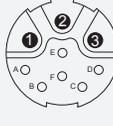
Part	Face View	Part Number	Description
		MB1RJN0601	M23, B Series, 6 position, 90° rotatable recep., less contacts
		MB1RJN0801	M23, B Series, 8 position (4+4), 90° rotatable recep., less contacts
		MB1RJN0901	M23, B Series, 9 position (4+5), 90° rotatable recep., less contacts
		MB1RJNNG36	M23, B Series, 9 position (3+6), 90° rotatable recep., less contacts (will accept 12AWG wire on the power)

Page intentionally left blank.

MotionGrade™ M23 Hybrid (DMC) Decentralized Motion Connector Series

Overview



Features & Benefits

Superior Shielding	First quality components coupled with a simplistic design provide maximum EMI/RFI shielding capabilities while reducing assembly preparation times.
Cable Strain Relief	Your choice of either the innovative design features of FlexGrip™ or traditional cable strain relieving similar to existing standard systems.
Fluid Resistance & Sealing	In combination with our strain relief systems, Amphenol utilizes advanced sealing technologies & materials to ensure highest reliability when subjected to the harshest environments.
RoHS Compliant Approvals	RoHS All materials meet the requirements of the European Directive 2002/95/EC, Issue 13.2.2003. ISO 9001/2000 UL & cUL Recognized ECBT2/ECBT8

Technical Specifications

Temperature Range	-20 to 130°C
Max. Current (AMP)	18A (2.0mm); 1A (1.0mm); 0.5A (Quad Element)
Voltage Rating (AC/DC)	850 (2.0mm/1.0mm Contacts); 30V (Quad Element)
Contact Resistance	< 15mΩ
Min. Mating Cycles	> 500
Transmission Rate	Quad Element -100MBit (CAT 5)

Technical Specifications, cont.

Test Voltage Rating	6000V (2.0mm); 1500V (1.0mm); 500V (Quad Element)
Sealing Protection	IP66/67 (plugged condition)
Protective Grounding	Per VDE 0627
Safety Protection	Per VDE 0623
Degree of Protection	3
Overvoltage Category	III
Strain Relief Clamp Range	7.5-11mm
Number of Contact (mm)	2 Power + PE (2.0mm) + 1 Signal (1.0mm) 4 Quad Element Ethernet (.7mm)
Wire Range (AWG)	14-18: 2.5 - 1.0mm ² (2.0mm) 18-22: 1.0 - 0.34mm ² (1.0mm) 28: 0.34 - 0.08mm ² (0.7mm)
Product Material	
Housing Body/Coupling Nut	Zinc Die-cast; Nickel-plate
Insulation Inserts	PA66, UL94/V0
Contacts	Brass, Gold-plated
Sealing Material	DuPont Viton®

Dimensional Drawings

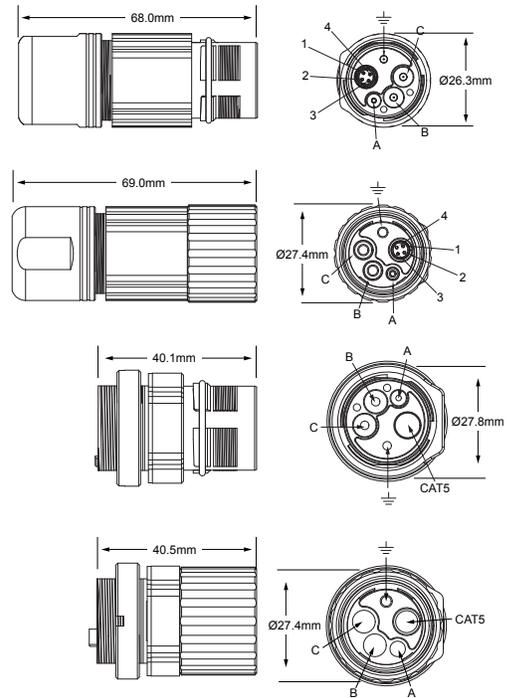

MotionGrade™ M23 Hybrid DMC | Standard Products

Below are a listing of all available M23 Hybrid DMC Series standard products. Contact your Sales Representative for more information.

Part	Face View	Part Number	Description
		MB3ZSN8HS1	M23, Hybrid, 2 Power + PE (2.0mm) + 1 Signal (1.0mm), 4 Quad Element Ethernet (.7mm), straight plug, male, less contacts
		MB3XSN8HS1	M23, Hybrid, 2 Power + PE (2.0mm) + 1 Signal (1.0mm), 4 Quad Element Ethernet (.7mm), straight plug, female, less contacts
		MB1YSN8H00	M23, Hybrid, 2 Power + PE (2.0mm) + 1 Signal (1.0mm), 4 Quad Element Ethernet (.7mm), straight receptacle, male, less contacts
		MB1WSN8H00	M23, Hybrid, 2 Power + PE (2.0mm) + 1 Signal (1.0mm), 4 Quad Element Ethernet (.7mm), straight receptacle, female, less contacts

MotionGrade™ M40 Series

Overview



Features & Benefits

Superior Shielding	First quality components coupled with a simplistic design provide maximum EMI/RFI shielding capabilities while reducing assembly preparation times.
Cable Strain Relief	Your choice of either the innovative design features of FlexGrip™ or traditional cable strain relieving similar to existing standard systems.
Fluid Resistance & Sealing	In combination with our strain relief systems, Amphenol utilizes advanced sealing technologies & materials to ensure highest reliability when subjected to the harshest environments.
RoHS Compliant	RoHS All materials meet the requirements of the European Directive 2002/95/EC, Issue 13.2.2003.
Approvals	ISO 9001/2000, UL Listed, E224856, CYJV/CYJV7
Pending Approvals	VDE

Technical Specifications

Temperature Range	-20°C to 130°C
Max. Current (AMP)	75A (Power), 30A (Signal)
Voltage Rating (AC/DC)	630V (Power), 250V (Signal)
Contact Resistance	< 1mΩ (Power), < 3mΩ (Signal)
Min. Mating Cycles	> 50
Test Voltage Rating	6000V (Power), 4000V (Signal)
Sealing Protection	IP67 (plugged condition)
Degree of Protection	3
Overvoltage Category	III
Strain Relief Clamp Range	7.5-11.0mm; 11.0-14.5mm; 14.5-17.0mm; 14.5-20.5mm; 20.5-26.0mm
Number of Contact (mm)	6 Pos: 2 (2.0mm) + 4 (3.6mm) 8 Pos: 4 (2.0mm) + 4 (3.6mm)
Wire Range (AWG)	Pins: 14-18AWG (2.0mm), 8-12AWG (3.6mm) Sockets: 14-18AWG (2.0mm), 8-12AWG (3.6mm)

Product Material

Housing Body/Coupling Nut	Zinc Die-cast/Brass, Nickel-plated
Insulation Inserts	PA66 / PBT, UL94/V0
Contacts	Brass, Gold-plated
Sealing Material	DuPont Viton®

Dimensional Drawings

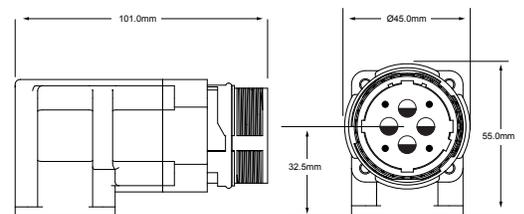
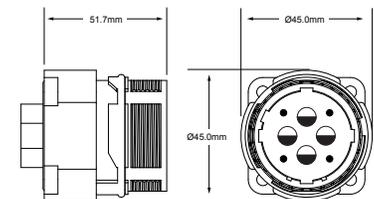
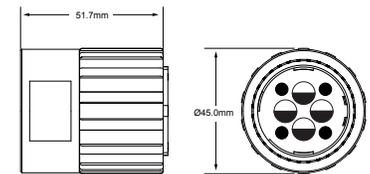
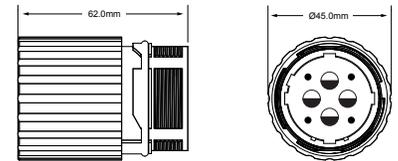

MotionGrade™ M40 | C Series Standard Products

Below are a listing of all available M40 C Series standard products. Contact your Sales Representative for more information.

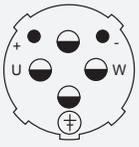
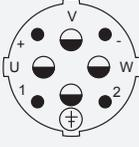
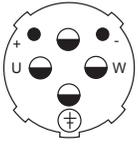
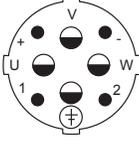
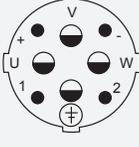
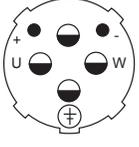
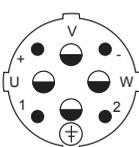
Part	Face View	Part Number	Description
		MC1CJN0600	M40, Series C, 6 pos. (4+2), straight plug, less contacts
		MC1CJN0800	M40, Series C, 8 pos. (4+4), straight plug, less contacts
		MC1JJN0600	M40, Series C, 6 pos. (4+2), extension connector, less contacts
		MC1JJN0800	M40, Series C, 8 pos. (4+4), extension connector, less contacts
		MC1LKN0600	M40, Series C, 6 pos. (4+2), straight receptacle, flange mount, less contacts
		MC1LKN0800	M40, Series C, 8 pos. (4+4), straight receptacle, flange mount, less contacts
		MC1NJN0600	M40, Series C, 6 pos. (4+2), 90° fixed receptacle, less contacts
		MC1NJN0800	M40, Series C, 8 pos. (4+4), 90° fixed receptacle, less contacts

Page intentionally left blank.

MotionGrade™ | Cord Grip & FlexGrip™ Backshell Options

Below are a listing of all available Cord Grip and FlexGrip™ backshells for both M23 and M40. Contact your Sales Representative for more information.

Part	Part Number	Description
	MA3CG-S1	M23, A Series, cord grip, cable range 4.5-7.5mm
	MA3CG-S2	M23, A Series, cord grip, cable range 7.5-11mm
	MA3CG-S3	M23, A Series, cord grip, cable range 11.0-15.0mm
	MA4FSR-A8.5	M23, A Series, FlexGrip™, cable range 7.5-8.5mm Note: FlexGrip™ Backshells must be potted to achieve IP67 ratings.
	MA4FSR-A10.5	M23, A Series, FlexGrip™, cable range 9.5-10.5mm Note: FlexGrip™ Backshells must be potted to achieve IP67 ratings.
	MA4FSR-A12.8	M23, A Series, FlexGrip™, cable range 11.5-12.8mm Note: FlexGrip™ Backshells must be potted to achieve IP67 ratings.
	MB3CG-S1	M23, B Series, cord grip, cable range 7.5-11mm
	MB3CG-S2	M23, B Series, cord grip, cable range 11.0-14.5mm
	MB3CG-S3	M23, B Series, cord grip, cable range 14.5-17mm

Part	Part Number	Description
	MB4FSR-B10.3	M23, B Series, FlexGrip™, cable range 9.5-10.3mm Note: FlexGrip™ Backshells must be potted to achieve IP67 ratings.
	MB4FSR-B12.5	M23, B Series, FlexGrip™, cable range 11.5-12.5mm Note: FlexGrip™ Backshells must be potted to achieve IP67 ratings.
	MB4FSR-B14.5	M23 B Series, FlexGrip™, cable range 13.5-14.5mm Note: FlexGrip™ Backshells must be potted to achieve IP67 ratings.
	MB4FSR-B17	M23 B Series, FlexGrip™, cable range 15.5-17mm Note: FlexGrip™ Backshells must be potted to achieve IP67 ratings.
	MC3CG-S1	M40, C Series, cord grip, cable range 9.0-12.5mm
	MC3CG-S2	M40, C Series, cord grip, cable range 12.5-14.5mm
	MC3CG-S3	M40, C Series, cord grip, cable range 14.5-17.0mm
	MC3CG-S4	M40, C Series, cord grip, cable range 17-19.5mm
	MC3CG-S5	M40, C Series, cord grip, cable range 19-21.5mm
	MC3CG-S6	M40, C Series, cord grip, cable range 21.5-24mm
	MC3CG-S7	M40, C Series, cord grip, cable range 25.5-26mm
	MC4FSR-C18.5	M40, C Series, FlexGrip™, cable range 17.5-18.5mm Note: FlexGrip™ Backshells must be potted to achieve IP67 ratings.

Cable Prep & Assembly

Steps 1-6 below show how to properly prepare a cable/connector using either a Cord Grip or FlexGrip™ backshell. Steps 7A-10A refer specifically to the Cord Grip option, while 7B-10B refer to the FlexGrip option. Contact Sales Representative for more information.

Step 1: Strip jacket material of P1 (Male) or P2 (Female) to 40mm (+/-1.0mm)

P1 (Male)



P2 (Female)



Step 2: Clean P1 (Male) or P2 (Female). Wrap copper foil (1/2") tightly onto shield braid, avoiding damage to foil. Cut excess braid wire off.



Step 3: Slide Cord Grip onto cable for P1 (Male) or P2 (Female).



Step 4: Strip P1 (Male) or P2 (Female) jacket material to 4mm (+/- 0.5mm)



Step 5: Crimp contacts onto P1 (Male) or P2 (Female)



Step 6: Insert crimped wires into backend of P1 (Male) or P2 (Female) connector body.



Step 7A: (Cord Grip Only) Thread Cord Grip Body onto backend of connector body tightly.



Step 8A: (Cord Grip Only) Slide EMI Shielding Ring onto copper foil surface, making sure EMI fines are seated properly onto copper foil.



Step 9A: (Cord Grip Only) Push Rubber Seal Grommet into backend of Cord Grip Body.

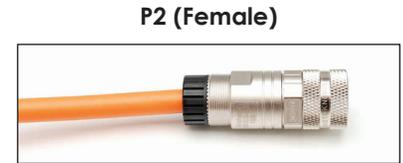

Step 10A: (Cord Grip Only) Thread Cord Grip Cap onto Cord Grip Body and tighten to torque specs. (insert torque specs here)



FlexGrip™ Prep Details: During cable prep specific to using the FlexGrip backshell, be sure excess shielding material is pulled back over the cable jacket and taped down. This allows for ease of sliding FlexGrip™ parts into place.

Note: ** Cable prep is same for P1 (Male) connectors using FlexGrip™ backshells as P2 (Female).

**

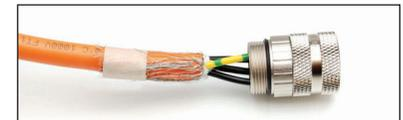

Step 7B: (FlexGrip™ Only) Thread into position the bottom part of the Two-Piece Clamp onto the backend of the connector body tightly, ensuring excess shielding material is still exposed underneath the Two-Piece Clamp.

**

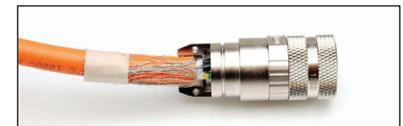

Step 8B: (FlexGrip™ Only) Place the top portion of the Two-Piece Clamp into position and use the enclosed screws to tighten into place.

**



Step 9B: (FlexGrip™ Only) Cut off excess shielding material behind Two-Piece Clamp.

**



Step 10B: (FlexGrip™ Only) Slide FlexGrip™ Shell over the backend portion of the Two-Piece Clamp hardware.

**



Receptacle Assembly

Assembly for M23 90° Receptacle

Step 1: Unscrew the backing of the 90° receptacle assembly.



Step 2: Remove the backing of the 90° receptacle assembly.



Step 3: Thread the crimped contact through the bottom and backing of the 90° receptacle assembly.



Step 4: Insert crimped wire into backend of the connector body.



Step 5: Insert the remainder of the crimped wires into backend of the connector body.



Step 6: Replace the backing of the 90° receptacle assembly.



Step 7: Screw the backing of the 90° receptacle assembly into position and tighten.

Complete.



Page intentionally left blank.

Contacts & Tooling

Contact Options

Below are a listing of all available machined contacts for the M23 and M40 product lines.

Series	Size	AWG	Type	Plating	Part Number	Contact	Extraction Tool
M23 A	1.0mm	18-22	Machined	Brass, Gold-plate	SC000035	Pin	50-54931-1
M23 A	1.0mm	24-28	Machined	Brass, Gold-plate	SC000146	Pin	50-54931-1
M23 A	1.0mm	18-22	Machined	Brass, Gold-plate	SC000044	Socket	50-54931-1
M23 A	1.0mm	24-28	Machined	Brass, Gold-plate	SC000030	Socket	50-54931-1

NOTE: M23 A Series connector configurations will accept pins or sockets.

M23 B	1.0mm	18-22	Machined	Brass, Gold-plate	SC000035	Pin	50-54931-1
M23 B	2.0mm	14-16	Machined	Brass, Gold-plate	SC000036	Pin	50-54931-2
M23 B	1.0mm	18-22	Machined	Brass, Gold-plate	SC000044	Socket	50-54931-1
M23 B	1.0mm	24-28	Machined	Brass, Gold-plate	SC000030	Socket	50-54931-1
M23 B	2.0mm	14-16	Machined	Brass, Gold-plate	SC000045	Socket	50-54931-2

NOTE: M23 B Series plugs accept sockets only. M23 B Series receptacles and extension connectors will accept pins only.

M23 Hybrid	#20	18-22	Machined	Brass, Gold-plate	SC000261	Pin	50-54931-1
M23 Hybrid	#14	14-18	Machined	Brass, Gold-plate	SC000262	Pin	50-54931-2
M23 Hybrid	#20	18-22	Machined	Brass, Gold-plate	SC000259	Socket	50-54931-1
M23 Hybrid	#14	14-18	Machined	Brass, Gold-plate	SC000260	Socket	50-54931-2
M23 Hybrid/Ethernet	0.7mm	22-28	Machined	Brass, Gold-plate	SC000263	Pin	N/A
M23 Hybrid/Ethernet	0.7MM	22-28	Machined	Brass, Gold-plate	SC000264	Socket	

M40 C	2.0mm	14-16	Machined	Brass, Gold-plate	SC000036	Pin	50-54931-2
M40 C	2.0mm	14-16	Machined	Brass, Gold-plate	SC000040	Pin	50-54931-2
M40 C	3.6mm	8-12	Machined	Brass, Gold-plate	SC000041	Pin	50-54931-3
M40 C	2.0mm	14-16	Machined	Brass, Gold-plate	SC000045	Socket	50-54931-2
M40 C	3.6mm	8-12	Machined	Brass, Gold-plate	SC000039	Socket	50-54931-3
M40 C	3.6mm	8-12	Machined	Brass, Gold-plate	SC000046	Socket	50-54931-3

NOTE: M40 C Series plugs accept sockets only. M40 C Series receptacles and extension connectors will accept pins only.

Crimp Tools

Below are a listing of all available crimp tools for the M23 and M40 product lines: Hand Crimp and Pneumatic. For each tool you must order the corresponding positioner separately.

Part	Part Number	Description
	AFM8	Universal Hand Crimp Tool, 1.0mm, wire range 20-32AWG *Uses Universal Positioner, P/N: SK2/2
	AF8	Universal Hand Crimp Tool, 2.0mm, wire range 12-26AWG *Uses Universal Positioner, P/N: UH2-5
	WA22	Pneumatic Crimp Tool, 1.0mm, wire range 20-32AWG *Uses Universal Positioner, P/N: SK2/2

Crimp Tools, cont.

Part	Part Number	Description
	WA27F	Pneumatic Crimp Tool, 2.0mm, wire range 12-26AWG *Uses Universal Positioner, P/N: UH2-5
	WA23	Pneumatic Crimp Tool, 3.6mm, wire range 8-10AWG *Uses Universal Positioner, P/N: WA23-101DA and MFX-3966

Extraction Tools

Below are a listing of all available extraction tools to assist with your contact/wire removal needs.

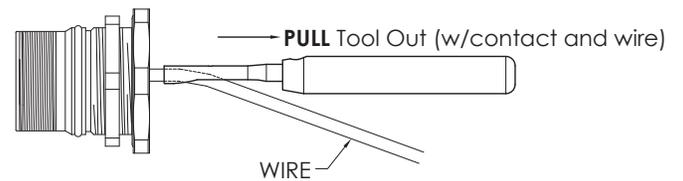
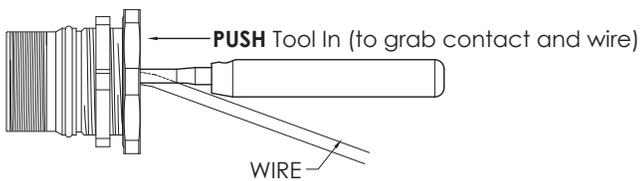

Part	Part Number	Description
	50-54931-1	Used for removal of 1.0mm contacts from inserts.
	50-54931-2	Used for removal of 2.0mm contacts from inserts.
	50-54931-3	Used for removal of 3.0mm contacts from inserts.

Amphenol Sine Systems

44724 Morley Drive
Clinton Township, MI 48036
United States
+1 586 465 3131
websitemanager@sineco.com
www.sineco.com

Amphenol Air LB France

29, voie d'yvois
Blagny F-08110 France
+33 3 24 22 78 49
accueil@amphenol-airlb.fr
www.amphenol-airlb.fr

Amphenol Air LB GmbH

Am Kleinbahnhof 4
Saarlouis, D-66740 Germany
+49 6831 981 00
info@amphenol-airlb.de
www.amphenol-airlb.de

Amphenol Alden Products

117 Noth Main Street
Brockton, MA 02301 United States
+1 508 427-7000
info@aldenproducts.com
www.Aldenproducts.com

Amphenol Australia Pty Ltd

2 Fiveways Blvd.
Melbourne, Keysborough, Victoria,
3173 Australia
+613 8796 8888
www.amphenol.com.au

Amphenol DaeShin Elect and Precision Co, Ltd

558 SongNae-Dong SoSa-Gu
Bucheon City, Kyunggi-Do,
420-130 Korea
+81 32 610 3800
info@amphenol.co.kr
www.amphenol.co.kr

Amphenol Fibersystem

1300 Central Expressway N.
Suite 100
Allen, TX 75013 United States
+1 214 547-2400
info@fibersystems.com
www.fibersystems.com

Amphenol Mexico Sales Op.

Prolongacion Reforma 61-6B2
Mexico City DF 01330, Mexico
+52 55 5258 99 84
info@amphenolmexico.com
www.amphenolmexico.com

Amphenol Interconnec India

105 Bhosari Industrial Area
Pune, 411 026 India
+91 20 2712 0462
info@amphenol-in.com
www.amphenol-in.com

Amphenol LTW Technology Co.,Ltd

9F, No. 657-12, Zhongzheng Road
Xinzhuan Dist, New Taipei City, 242 Taiwan
+886-2-2908-5626
info@ltw-tech.com
www.amphenolltw.com

Amphenol Limited

Thanet Way, Whistable
Kent, CT53JF United Kingdom
+44 (0) 1227 773 200
info@amphenol.co.uk
www.amphenol.co.uk

Amphenol PCD Shenzhen Co. LTD

Building 21, 1st Liao Keng Industrial Zone
Shi yan street, bao an district, Shenzhen
518108 China
+86 755 8173 8000
www.amphenolpcd.com.cn

Amphenol PCD, Inc.

72 Cherry Hill Drive
Beverly, MA 01915 United States
+1 978 624-3400
accueil@amphenolpcd.com
www.amphenolpcd.com

Amphenol Socapex S.A.S

948, Promenade de l'Arve, BP29
Thyez Cedex, 74311 France
+33 4 5089 2800
contact@amphenol-socapex.fr
www.amphenol-socapex.fr

Amphenol Terrier Technologies Systems

Unit 14, Northlake Industrial Park
Malcolm Moodie Crescent
Jet Park, South Africa
+27 11 397 6069
clive@terriertech.co.za
www.terriertech.co.za

Amphenol Tuchel Electronics - China

20 Tianshan Road-Changzhou
Changzou, Jiangsu, 213022 China
85 519 511 0301
www.amphenol.info

Amphenol Tuchel Electronics GmbH

August-Haeusser-Strasse 10
Heilbronn, D-74080 Germany
+49 (0) 7131 929 0
info@amphenol.de
www.amphenol.de



Компания «ЭлектроПласт» предлагает заключение долгосрочных отношений при поставках импортных электронных компонентов на взаимовыгодных условиях!

Наши преимущества:

- Оперативные поставки широкого спектра электронных компонентов отечественного и импортного производства напрямую от производителей и с крупнейших мировых складов;
- Поставка более 17-ти миллионов наименований электронных компонентов;
- Поставка сложных, дефицитных, либо снятых с производства позиций;
- Оперативные сроки поставки под заказ (от 5 рабочих дней);
- Экспресс доставка в любую точку России;
- Техническая поддержка проекта, помощь в подборе аналогов, поставка прототипов;
- Система менеджмента качества сертифицирована по Международному стандарту ISO 9001;
- Лицензия ФСБ на осуществление работ с использованием сведений, составляющих государственную тайну;
- Поставка специализированных компонентов (Xilinx, Altera, Analog Devices, Intersil, Interpoint, Microsemi, Aeroflex, Peregrine, Syfer, Eurofarad, Texas Instrument, Miteq, Cobham, E2V, MA-COM, Hittite, Mini-Circuits, General Dynamics и др.);

Помимо этого, одним из направлений компании «ЭлектроПласт» является направление «Источники питания». Мы предлагаем Вам помощь Конструкторского отдела:

- Подбор оптимального решения, техническое обоснование при выборе компонента;
- Подбор аналогов;
- Консультации по применению компонента;
- Поставка образцов и прототипов;
- Техническая поддержка проекта;
- Защита от снятия компонента с производства.



Как с нами связаться

Телефон: 8 (812) 309 58 32 (многоканальный)

Факс: 8 (812) 320-02-42

Электронная почта: org@eplast1.ru

Адрес: 198099, г. Санкт-Петербург, ул. Калинина, дом 2, корпус 4, литера А.