

Automotive ultrafast recovery diode

Datasheet - production data

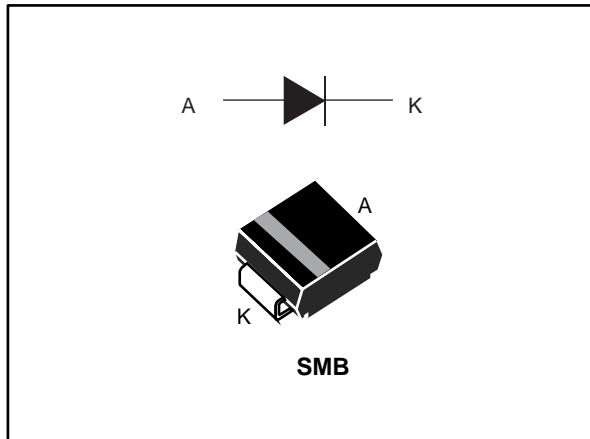

Description

This device uses ST's new 200 V planar Pt doping technology, and is specially suited for switching mode base drive and transistor circuits.

Packaged in SMB, it is intended for use in low voltage, high frequency inverters, freewheeling and polarity protection in automotive applications.

Table 1: Device summary

Symbol	Value
$I_{F(AV)}$	2 A
V_{RRM}	200 V
T_j (max.)	175 °C
V_F (typ.)	0.7 V
t_{rr} (typ.)	15 ns

Features

- AEC-Q101 qualified
- Very low conduction losses
- Negligible switching losses
- Low forward and reverse recovery times
- High junction temperature
- PPAP capable



1 Characteristics

Table 2: Absolute ratings (limiting values per diode at 25 °C, unless otherwise specified)

Symbol	Parameter		Value	Unit
V _{RRM}	Repetitive peak reverse voltage		200	V
I _{FRM}	Repetitive peak forward current	t _p = 5 μs, f = 5 kHz	60	A
I _{F(RMS)}	Forward rms current		60	A
I _{F(AV)}	Average forward current δ = 0.5, square wave	T _{lead} = 90 °C	2	A
I _{FSM}	Surge non repetitive forward current	t _p = 10 ms sinusoidal	75	A
T _{stg}	Storage temperature range		-65 to +175	°C
T _j	Maximum operating junction temperature ⁽¹⁾		-40 to +175	°C

Notes:

⁽¹⁾(dP_{tot}/dT_j) < (1/R_{th(j-a)}) condition to avoid thermal runaway for a diode on its own heatsink.

Table 3: Thermal parameters

Symbol	Parameter	Maximum	Unit
R _{th(j-l)}	Junction to lead	30	°C/W

Table 4: Static electrical characteristics (per diode)

Symbol	Parameter	Test conditions		Min.	Typ.	Max.	Unit
		T _j	I _F				
I _R ⁽¹⁾	Reverse leakage current	T _j = 25 °C	V _R = V _{RRM}	-		3	μA
		T _j = 125 °C		-	2	20	
V _F ⁽²⁾	Forward voltage drop	T _j = 25 °C	I _F = 6 A	-		1.20	V
		T _j = 25 °C	I _F = 2 A	-	0.89	1.0	
		T _j = 100 °C		-	0.76	0.85	
		T _j = 150 °C		-	0.70	0.80	

Notes:

⁽¹⁾Pulse test: t_p = 5 ms, δ < 2%

⁽²⁾Pulse test: t_p = 380 μs, δ < 2 %

To evaluate the conduction losses, use the following equation:

$$P = 0.68 \times I_{F(AV)} + 0.06 \times I_{F(RMS)}^2$$

Table 5: Dynamic characteristics

Symbol	Parameters	Test conditions	Min.	Typ.	Max.	Unit	
t_{rr}	Reverse recovery time	$T_j = 25\text{ °C}$	$I_F = 1\text{ A};$ $di_F/dt = -50\text{ A}/\mu\text{s};$ $V_R = 30\text{ V}$	-	23	30	ns
			$I_F = 1\text{ A};$ $di_F/dt = -100\text{ A}/\mu\text{s};$ $V_R = 30\text{ V}$	-	15	20	
t_{fr}	Forward recovery time	$T_j = 25\text{ °C}$	$I_F = 2\text{ A};$ $di_F/dt = 100\text{ A}/\mu\text{s};$ $V_{FR} = 1.1 \times V_{Fmax}$	-	40		
V_{FP}	Forward recovery voltage		$I_F = 2\text{ A};$ $di_F/dt = 100\text{ A}/\mu\text{s}$	-	2.0		V
I_{RM}	Reverse recovery current	$T_j = 125\text{ °C}$	$I_F = 2\text{ A};$ $di_F/dt = -200\text{ A}/\mu\text{s};$ $V_R = 160\text{ V}$	-	3	4	A

1.1 Characteristics (curves)

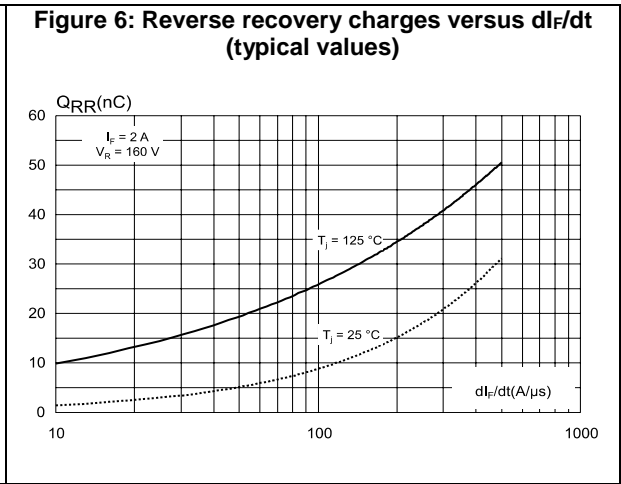
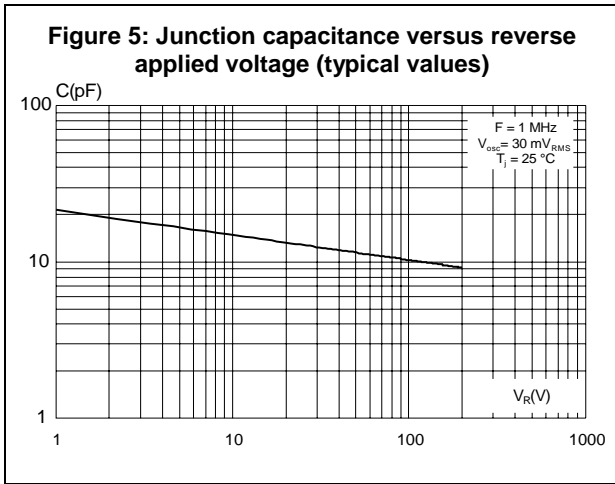
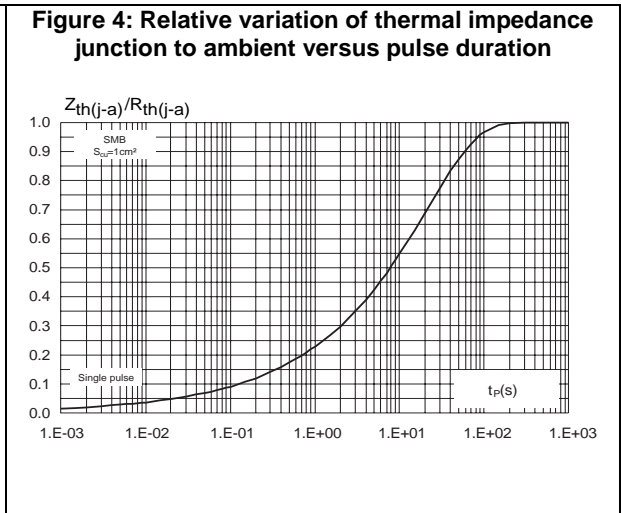
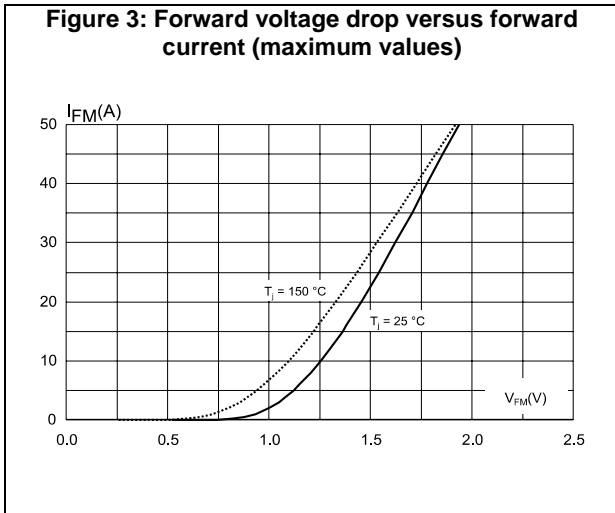
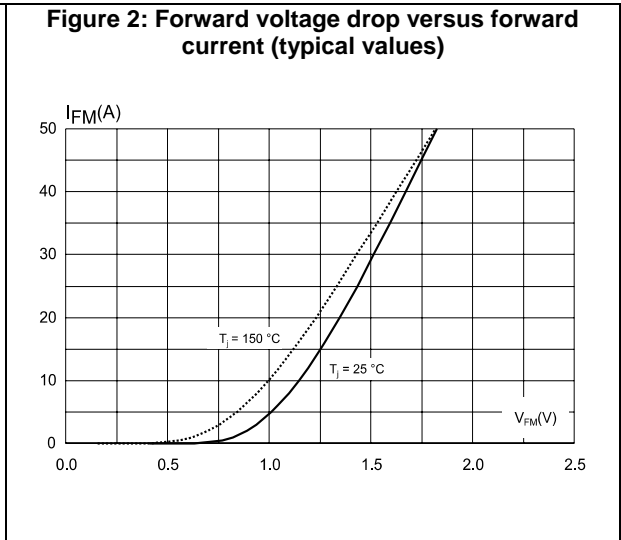
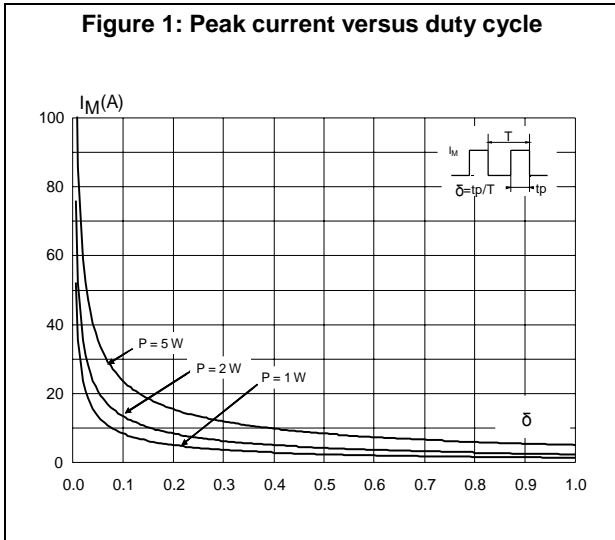

Figure 7: Reverse recovery time versus di_f/dt (typical values)

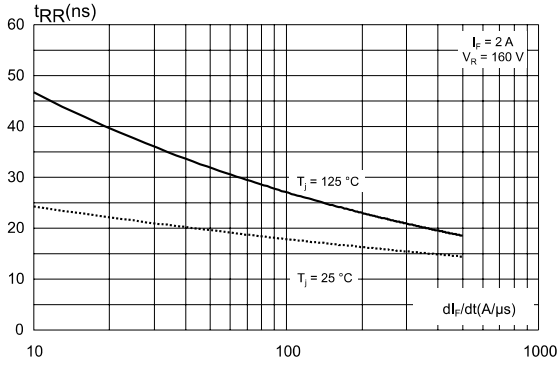

Figure 8: Peak reverse recovery current versus di_f/dt (typical values)

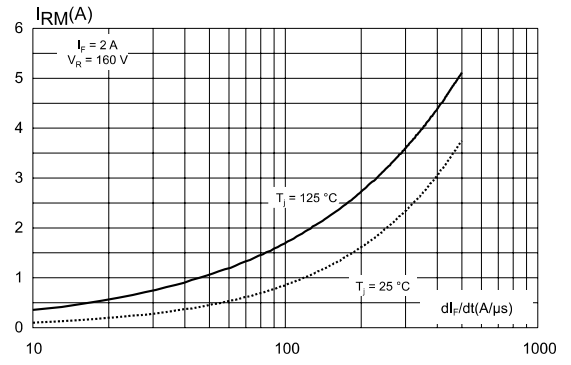

Figure 9: Dynamic parameters versus junction temperature

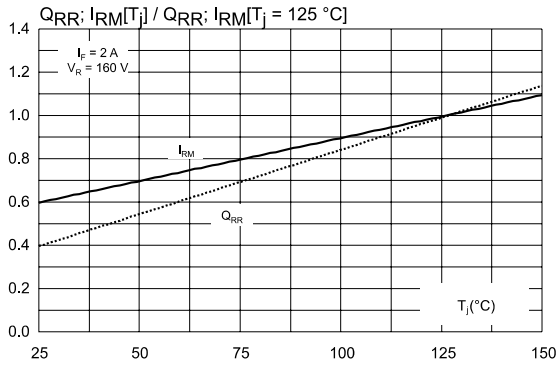
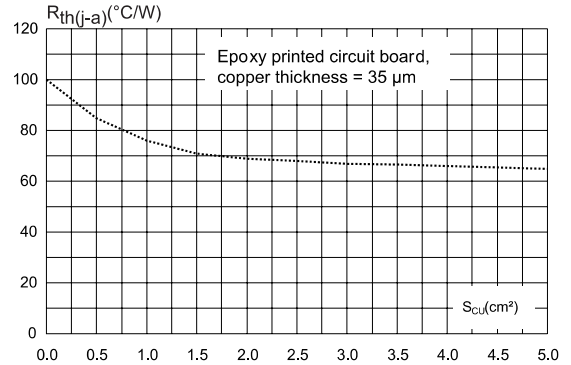

Figure 10: Thermal resistance, junction to ambient, versus copper surface under each lead



2 Package information

In order to meet environmental requirements, ST offers these devices in different grades of ECOPACK® packages, depending on their level of environmental compliance. ECOPACK® specifications, grade definitions and product status are available at: www.st.com. ECOPACK® is an ST trademark.

- Epoxy meets UL94, V0
- Lead-free package

2.1 SMB package information

Figure 11: SMB package outline

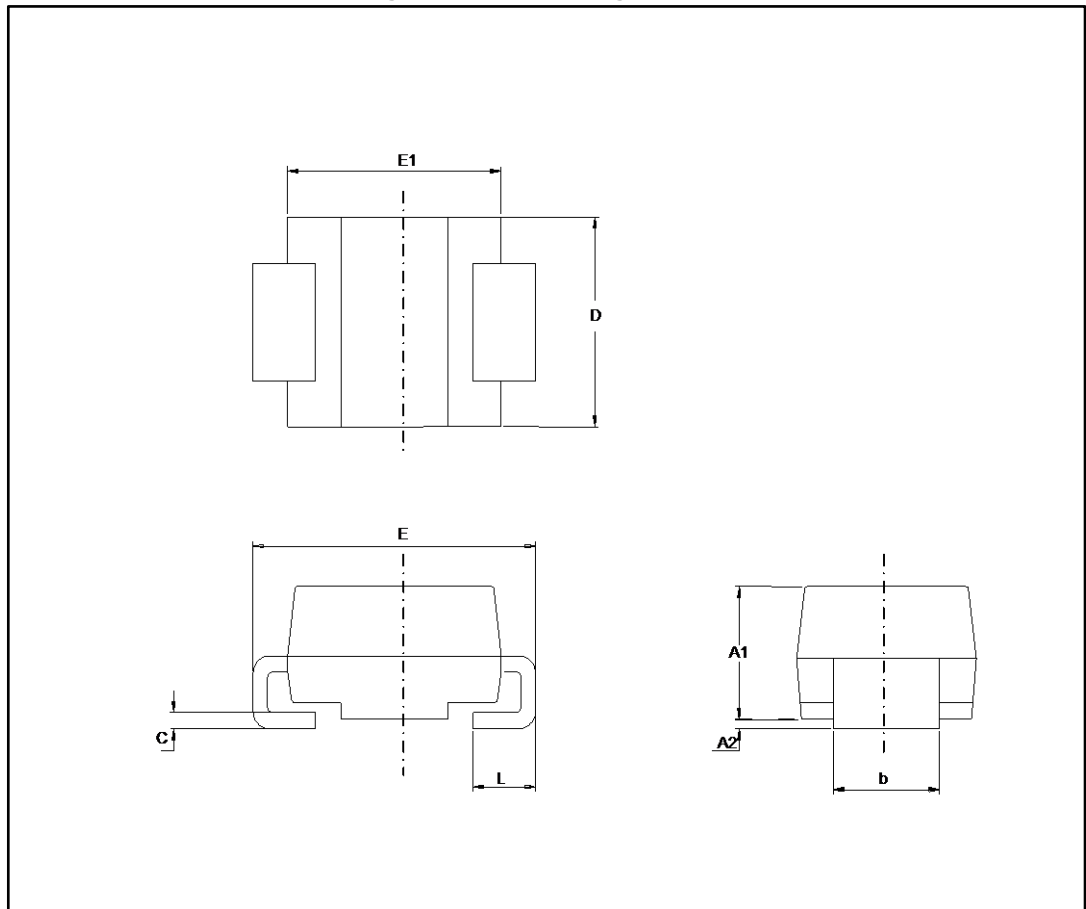
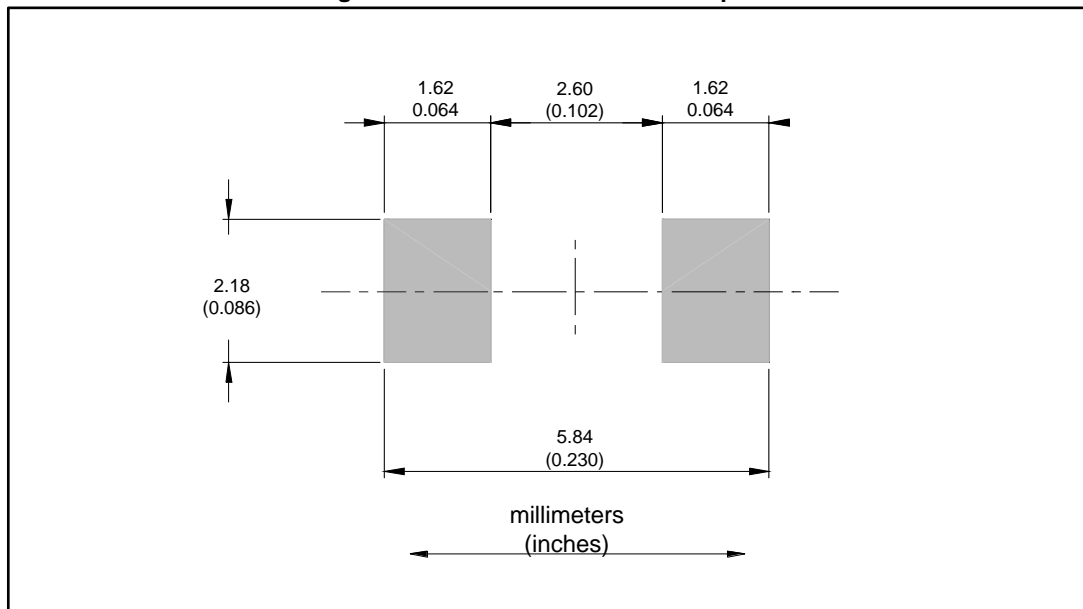

Table 6: SMB package mechanical data

Ref.	Dimensions			
	Millimeters		Inches	
	Min.	Max.	Min.	Max.
A1	1.90	2.45	0.0748	0.0965
A2	0.05	0.20	0.0020	0.0079
b	1.95	2.20	0.0768	0.0867
c	0.15	0.40	0.0059	0.0157
D	3.30	3.95	0.1299	0.1556
E	5.10	5.60	0.2008	0.2205
E1	4.05	4.60	0.1594	0.1811
L	0.75	1.50	0.0295	0.0591

Figure 12: SMB recommended Footprint



3 Ordering information

Figure 13: Ordering information scheme

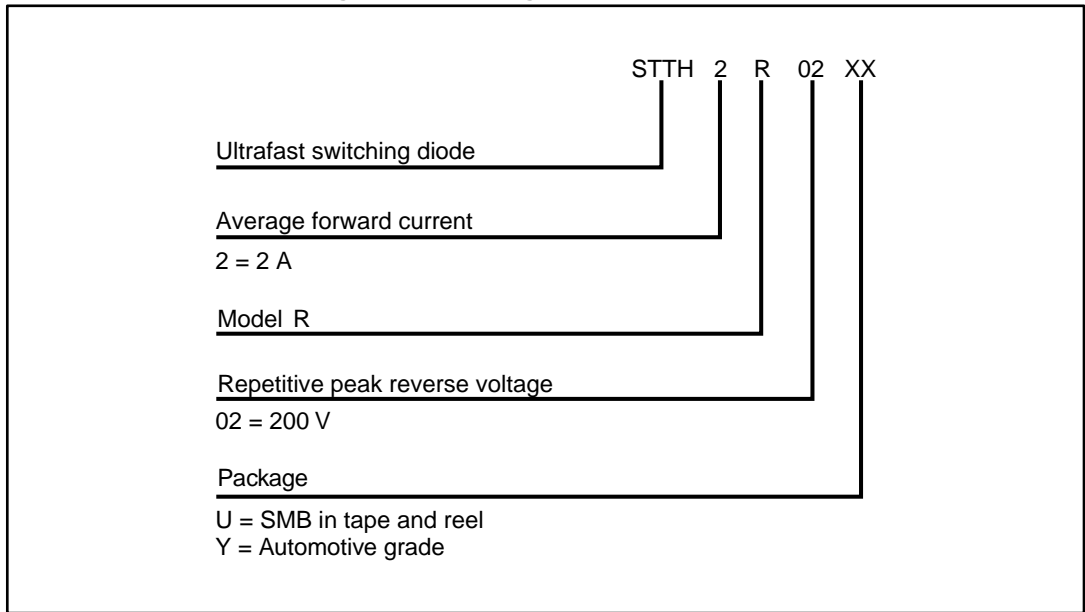

Table 7: Ordering information

Order code	Marking	Package	Weight	Base qty.	Delivery mode
STTH2R02UY	R2UY	SMB	0.110 g	2500	Tape and reel

4 Revision history

Table 8: Document revision history

Date	Revision	Changes
20-Oct-2010	1	Initial release.
02-Feb-2017	2	Updated Figure 4 : "Relative variation of thermal impedance junction to case versus pulse duration".

IMPORTANT NOTICE – PLEASE READ CAREFULLY

STMicroelectronics NV and its subsidiaries ("ST") reserve the right to make changes, corrections, enhancements, modifications, and improvements to ST products and/or to this document at any time without notice. Purchasers should obtain the latest relevant information on ST products before placing orders. ST products are sold pursuant to ST's terms and conditions of sale in place at the time of order acknowledgement.

Purchasers are solely responsible for the choice, selection, and use of ST products and ST assumes no liability for application assistance or the design of Purchasers' products.

No license, express or implied, to any intellectual property right is granted by ST herein.

Resale of ST products with provisions different from the information set forth herein shall void any warranty granted by ST for such product.

ST and the ST logo are trademarks of ST. All other product or service names are the property of their respective owners.

Information in this document supersedes and replaces information previously supplied in any prior versions of this document.

© 2017 STMicroelectronics – All rights reserved



Компания «ЭлектроПласт» предлагает заключение долгосрочных отношений при поставках импортных электронных компонентов на взаимовыгодных условиях!

Наши преимущества:

- Оперативные поставки широкого спектра электронных компонентов отечественного и импортного производства напрямую от производителей и с крупнейших мировых складов;
- Поставка более 17-ти миллионов наименований электронных компонентов;
- Поставка сложных, дефицитных, либо снятых с производства позиций;
- Оперативные сроки поставки под заказ (от 5 рабочих дней);
- Экспресс доставка в любую точку России;
- Техническая поддержка проекта, помощь в подборе аналогов, поставка прототипов;
- Система менеджмента качества сертифицирована по Международному стандарту ISO 9001;
- Лицензия ФСБ на осуществление работ с использованием сведений, составляющих государственную тайну;
- Поставка специализированных компонентов (Xilinx, Altera, Analog Devices, Intersil, Interpoint, Microsemi, Aeroflex, Peregrine, Syfer, Eurofarad, Texas Instrument, Miteq, Cobham, E2V, MA-COM, Hittite, Mini-Circuits, General Dynamics и др.);

Помимо этого, одним из направлений компании «ЭлектроПласт» является направление «Источники питания». Мы предлагаем Вам помощь Конструкторского отдела:

- Подбор оптимального решения, техническое обоснование при выборе компонента;
- Подбор аналогов;
- Консультации по применению компонента;
- Поставка образцов и прототипов;
- Техническая поддержка проекта;
- Защита от снятия компонента с производства.



Как с нами связаться

Телефон: 8 (812) 309 58 32 (многоканальный)

Факс: 8 (812) 320-02-42

Электронная почта: org@eplast1.ru

Адрес: 198099, г. Санкт-Петербург, ул. Калинина, дом 2, корпус 4, литера А.