

Series
45
Catalogue

www.eao.com



Expert manufacturers. *EAO creates possibilities. Since 1947.*



Founding year: 1947

Number of employees: 600

Headquarters: Olten, Switzerland

Manufacturing Companies: Switzerland,
Germany, North America, China

Sales Companies: 11

Distribution countries: 50

Core markets: Transportation, Automotive,
Heavy Duty & Special Vehicles, Machinery

EAO AG, a Swiss, family-owned company founded in 1947, has developed into one of the world's leading manufacturers of high-quality industrial switches, complete custom HMI panels and interface systems, and specialised automotive switch systems.

Efficient and modern development processes, effective global supply chains and skilled project and consultation management represent additional services that we offer our customers and business partners around the world.

Your solution-focused expert and partner

We do much more than just manufacture individual control elements. As a solution-focused partner, we provide the option of technically and mechanically customizing existing HMI Components in line with our customers' individual requirements. From simple control elements through to sophisticated HMI Systems, from serial production through to installation – we offer the entire range of HMI services and inspire the confidence of our customers.

Customer-oriented.

More than an expert, a partner.



Being close to customers and able to offer a comprehensive range of services are fundamental to our success and at the core of our corporate policy.

EAO's production sites in Switzerland, Germany, North America and China combine volume production, development, research, and logistics. In addition to these centres of competence, EAO has 11 sales companies around the world at its disposal.

Thanks to this comprehensive network and our 50 distribution companies in the major industrialized countries, EAO is represented wherever interactions between humans and machines play key roles.

Control.

For every application.

Operator Device

Actuators and indicators for controlling specific and basic machine functions.

Handheld Control Unit

HMI solutions for mobile control units.



Regardless of the industrial demands placed on our HMI Components and Systems, reliability, longevity, intuitive operation and safety are always at the heart of our products and solutions. Our aim is to provide control over these processes and to afford machine operators the greatest possible level of protection at all times.

Main Operator Panel

HMI Components and Systems for main control units for the overall control of machinery.



Series 45.

Modular, aesthetic and robust in use.



Innovative and comprehensive *Series 45*

EAO's Series 45 unites an extremely broad range of machine operating functions with outstanding technical properties. Penetration by dust and liquids is prevented even under the most adverse conditions.

Robust industrial control system

Resistant to aggressive cleaning agents, oils, dyes and other chemical substances, the actuators and indicators of the new Series 45 work perfectly each and every time. Our HMIs literally keep their cool in the face of high humidity and extreme fluctuations in temperature. Functionality is preserved even when the control units are subjected to dust or water at high pressures (IP69K). Series 45 is ideal for use in the most adverse conditions.

High level of modularity

Their modular construction ensures that our HMI Components all operate smoothly with each other. They are straightforward to install and can also be integrated easily into decentralised systems.

Full functionality

Every conceivable HMI function can be performed by products from Series 45. Pushbuttons, illuminated pushbuttons, indicators, selector switches, keylock switches, toggle sticks and emergency stop switches are capable of handling all major functions.

Major benefits

- Comprehensive Series
- Easy to use, modular construction and rapid assembly without special tools
- Rugged in use; IP69K front protection and metal models
- Modern design thanks to flush mounting, attractive illumination and metallic or plastic appearance
- Low energy consumption thanks to LEDs
- Long service life (up to 10 million switching cycles)

Overview	
Numbering structure	8
Flush design	
Indicator	20
Pushbutton	21
Illuminated pushbutton	23
Keylock switch	25
Selector switch	26
Raised design	
Indicator	34
Pushbutton	38
Double pushbutton	49
Illuminated pushbutton	51
Double pushbutton illuminated	59
Emergency stop switch	61
Stop switch	63
Mushroom-head pushbutton	65
Keylock switch	84
Selector switch	88
Potentiometer	107
Toggle stick	109
Toggle switch	111
Accessories	112
Drawings	144
Technical data	151
Marking	160
Application guidelines	167
Index	168

45 Numbering structure

Indicator

45 - 2 T XX . X X X 0 . 0 0 0

Actuator

T = Indicator

Function

00 = Full face illumination

07 = Front illumination

Material

1 = Plastic

2 = Metal

3 = Metal/plastic

4 = Metal/matt

Shape of handle or front ring

F = flush

0 = raised

Colour

E = red transparent

F = amber transparent

G = yellow transparent

H = green transparent

J = blue transparent

K = colourless transparent

N = white transparent

Pushbutton

45 - 2 1 XX . X X X 0 . 0 0 0

Actuator

1 = Pushbutton

Function

31 = 2 positions, momentary

34 = 2 positions, maintain, push to release

Material

1 = Plastic

2 = Metal

3 = Metal / plastic

4 = Metal / matt

Shape of handle or front ring

1 = raised / lens level with front ring

2 = raised / lens raised above front ring

3 = raised / lens lower than front ring

4 = raised / lens lower than front ring, with castallations

F = flush

Colour

1 = black

2 = red

4 = yellow

5 = green

6 = blue

8 = grey

9 = white

K = clear transparent

45 Numbering structure

Double pushbutton, Double pushbutton illuminated

45 - 2 X XX . X X X 0 . 0 0 0

Actuator

J = Double pushbutton

K = Double pushbutton illuminated

Function

31 = 2 positions, momentary

Material

1 = Plastic

2 = Metal

3 = Metal/plastic

Shape of handle

5 = 2 lenses level with front ring

6 = lens level with front ring/ lens level raised above front ring

Colour

T = green/red

V = white/black

Illuminated pushbutton

45 - 2 2 XX . X X X 0 . 0 0 0

Actuator

2 = Illuminated pushbutton

Function

31 = 2 positions, momentary

34 = 2 positions, maintain, push to release

Material

1 = Plastic

2 = Metal

3 = Metal / plastic

4 = Metal / matt

Shape of handle or front ring

1 = raised / lens level with front ring

2 = raised / lens raised above front ring

4 = raised / lens lower than front ring, with castallations

F = flush

Colour

E = red transparent

F = amber transparent

G = yellow transparent

H = green transparent

J = blue transparent

K = colourless transparent

N = white transparent

45 Numbering structure

Emergency stop switch

45 - 2 X XX . X X X 0 . 0 0 0

Actuator

C = Emergency stop switch

D = Emergency stop switch, illuminated

Function

35 = Key to release

36 = Twist to release

37 = Pull to release

Material

1 = Plastic

Shape of handle or front ring

8 = Diameter 30 mm

9 = Diameter 40 mm

A = Diameter 60 mm

Colour

2 = red

Stop switch

45 - 2 7 XX . X X X 0 . 0 0 0

Actuator

7 = Stop switch

Function

36 = Twist to release

Material

1 = Plastic

Shape of handle or front ring

9 = Diameter 40mm

Colour

1 = black

45 Numbering structure

Mushroom-head pushbutton

45 - 2 X XX . X X X 0 . 0 0 0

Actuator

5 = Mushroom-head pushbutton

6 = Mushroom-head pushbutton, illuminated

Function

30 = 2 positions, maintain, pull release

31 = 2 positions, momentary

32 = 3 positions, maintain/momentary, pull release

Material

1 = Plastic

2 = Metal

3 = Metal/plastic

Shape of handle or front ring

8 = Diameter 30 mm

9 = Diameter 40 mm

A = Diameter 60 mm

Colour

1 = black

2 = red

4 = yellow

5 = green

Keylock switch

45 - 2 9 XX . X X 0 0 . X X X

Actuator

9 = Keylock switch

Function

0C = 3 positions, maintain, key remove L/R

0D = 3 positions, maintain, key remove L

0F = 3 positions, maintain, key remove L/C/R

0G = 3 positions, maintain, key remove L/C

0H = 2 positions, maintain, key remove L/R

0J = 2 positions, maintain, key remove L

0K = 2 positions, maintain, key remove L

0Z = 3 positions, maintain, key remove C

11 = 3 positions, momentary/maintain, key remove C

17 = 3 positions, maintain, key remove R

22 = 3 positions, maintain/momentary, key remove C

24 = 3 positions, maintain, key remove C

25 = 2 positions, maintain, key remove R

Material

1 = Plastic

2 = Metal

3 = Metal/plastic

4 = Metal/matt

Shape of handle or front ring

F = flush

0 = raised

Lock System

1 = RONIS

Key

1 = T254

Angle

1 = 90° (V-Pos)

3 = 2x45° (V-Pos)

6 = 45° (0-Pos.12 o'clock)

45 Numbering structure

Selector switch

45 - 2 8 XX . X X X 0 . 0 0 X

Actuator

8 = Selector switch

Function

0S = 3 positions, momentary

0X = 3 positions, momentary L, maintain R

16 = 3 positions, momentary R, maintain L

19 = 3 positions, maintain

28 = 2 positions, maintain

44 = 2 positions, momentary

45 = 4 positions, Maintain, (0-Position 15h/18h/21h/12h)

Material

1 = Plastic

2 = Metal

3 = Metal/plastic

4 = Metal/matt

Shape of handle or front ring

C = short lever

D = long lever

E = round lever

Colour

2 = red

4 = yellow

5 = green

6 = blue

9 = white

Angle

1 = 90° (V-Pos)

2 = 4x90°

3 = 2x45° (V-Pos)

6 = 45° (0-Pos.12 o'clock)

Potentiometer

45 - 2 P XX . X X X 0 . 0 0 0

Actuator

P = Potentiometer

Function

01 = 100kOhm

02 = 10kOhm

03 = 1kOhm

04 = 4.7kOhm

05 = 470kOhm

06 = 47kOhm

Material

1 = Plastic

2 = Metal

Shape of handle or front ring

E = round lever

Colour

1 = black

45 Numbering structure

Toggle stick

45 - 2 F XX . X X X 0 . 0 0 0

Actuator	2	F	XX	.	X	X	X	0	.	0	0	0
F = Toggle stick		█										
Function												
0T = 2 positions, momentary, L/R			█									
0V = 4 positions, momentary, L/R/U/D			█									
13 = 2 positions, momentary, L/R, lockable C			█									
14 = 4 positions, momentary, L/R/U/D, lockable C			█									
20 = 2 positions, maintain, L/R			█									
21 = 4 positions, maintain, L/R/U/D			█									
26 = 2 positions, maintain, L/R, lockable C			█									
27 = 4 positions, maintain, L/R/U/D, lockable C			█									
38 = 2 positions, momentary U/D			█									
40 = 2 positions, momentary, U/D, lockable C			█									
41 = 2 positions, maintain, U/D			█									
43 = 2 positions, maintain, U/D, lockable			█									
Material												
1 = Plastic												
2 = Metal												
3 = Metal/plastic												
Colour												
1 = black												

Toggle switch

45 - 2 N XX . X 0 1 0 . 0 0 0

Actuator

N = Toggle switch

Funktion

39 = 2 positions, momentary

42 = 2 positions, maintain

Material

1 = Plastic

2 = Metal

3 = Metal/plastic

45 Flush design

Indicator, IP66, IP67, IP69K



Product can differ from the current configuration.



Dimensions [mm]

Equipment consisting of (schematic overview)



Actuator



Holder

page 130



Illumination element

page 134

Additional Information

- Mounting depth incl. front plate, see chapter «drawings»
- Front panel thickness 1 ... 6 mm



Mounting cut-outs [mm]

Each Part Number listed below includes all the black components shown in the 3D-drawing.

To obtain a complete unit, please select the red components from the pages shown.

LED colour	Front ring	Lens cap	Part No.	Weight
	Indicator actuator, Front dimension Ø 38 mm			
red	Metal sandgrey	Plastic red transparent	45-2T07.4FE0.000	0.048 kg
	Indicator actuator, Front dimension Ø 38 mm			
yellow	Metal sandgrey	Plastic yellow transparent	45-2T07.4FG0.000	0.048 kg
	Indicator actuator, Front dimension Ø 38 mm			
green	Metal sandgrey	Plastic green transparent	45-2T07.4FH0.000	0.048 kg
	Indicator actuator, Front dimension Ø 38 mm			
blue	Metal sandgrey	Plastic blue transparent	45-2T07.4FJ0.000	0.048 kg
	Indicator actuator, Front dimension Ø 38 mm			
white	Metal sandgrey	Plastic colourless transparent	45-2T07.4FK0.000	0.048 kg

Pushbutton, IP66, IP67, IP69K

Equipment consisting of (schematic overview)



Actuator



Holder

page 130



Switching element

page 132

Each Part Number listed below includes all the black components shown in the 3D-drawing.

To obtain a complete unit, please select the red components from the pages shown.



Dimensions [mm]



Product can differ from the current configuration.



Mounting cut-outs [mm]

Additional Information

- Mounting depth incl. front plate, see chapter «drawings»
- Front panel thickness 1 ... 6 mm

Front ring	Lens	Switching action	Part No.	Wiring diagram	Weight
	Pushbutton actuator, Momentary, Front dimension Ø 38 mm				
Metal sandgrey	Plastic black	B	45-2131.4F10.000	1	0.048 kg
	Pushbutton actuator, Momentary, Front dimension Ø 38 mm				
Metal sandgrey	Plastic red	B	45-2131.4F20.000	1	0.048 kg
	Pushbutton actuator, Momentary, Front dimension Ø 38 mm				
Metal sandgrey	Plastic yellow	B	45-2131.4F40.000	1	0.048 kg
	Pushbutton actuator, Momentary, Front dimension Ø 38 mm				
Metal sandgrey	Plastic green	B	45-2131.4F50.000	1	0.048 kg
	Pushbutton actuator, Momentary, Front dimension Ø 38 mm				
Metal sandgrey	Plastic blue	B	45-2131.4F60.000	1	0.048 kg

45 Flush design

Front ring	Lens	Switching action	Part No.	Wiring diagram	Weight
	Pushbutton actuator, Momentary, Front dimension Ø 38 mm				
Metal sandgrey	Plastic white	B	45-2131.4F90.000	1	0.048 kg
	Pushbutton actuator, Maintain, Front dimension Ø 38 mm				
Metal sandgrey	Plastic black	C	45-2134.4F10.000	2	0.048 kg
	Pushbutton actuator, Maintain, Front dimension Ø 38 mm				
Metal sandgrey	Plastic red	C	45-2134.4F20.000	2	0.048 kg
	Pushbutton actuator, Maintain, Front dimension Ø 38 mm				
Metal sandgrey	Plastic yellow	C	45-2134.4F40.000	2	0.048 kg
	Pushbutton actuator, Maintain, Front dimension Ø 38 mm				
Metal sandgrey	Plastic green	C	45-2134.4F50.000	2	0.048 kg
	Pushbutton actuator, Maintain, Front dimension Ø 38 mm				
Metal sandgrey	Plastic blue	C	45-2134.4F60.000	2	0.048 kg
	Pushbutton actuator, Maintain, Front dimension Ø 38 mm				
Metal sandgrey	Plastic white	C	45-2134.4F90.000	2	0.048 kg

Switching action: B = Momentary, C = Maintain

E---	E~--
Wiring diagram 1	Wiring diagram 2

Illuminated pushbutton, IP66, IP67, IP69K

Equipment consisting of (schematic overview)



Actuator



Holder

page 130



Switching element

page 132



Illumination element

page 134

Each Part Number listed below includes all the black components shown in the 3D-drawing.

To obtain a complete unit, please select the red components from the pages shown.



Dimensions [mm]



Product can differ from the current configuration.



Mounting cut-outs [mm]

Additional Information

- Mounting depth incl. front plate, see chapter «drawings»
- Front panel thickness 1 ... 6 mm

LED colour	Front ring	Lens	Switching action	Part No.	Wiring diagram	Weight
 <p>Illuminated pushbutton actuator, Momentary, Front dimension Ø 38 mm</p>						
red	Metal sandgrey	Plastic red transparent	B	45-2231.4FE0.000	1	0.048 kg
 <p>Illuminated pushbutton actuator, Momentary, Front dimension Ø 38 mm</p>						
yellow	Metal sandgrey	Plastic yellow transparent	B	45-2231.4FG0.000	1	0.048 kg
 <p>Illuminated pushbutton actuator, Momentary, Front dimension Ø 38 mm</p>						
green	Metal sandgrey	Plastic green transparent	B	45-2231.4FH0.000	1	0.048 kg
 <p>Illuminated pushbutton actuator, Momentary, Front dimension Ø 38 mm</p>						
blue	Metal sandgrey	Plastic blue transparent	B	45-2231.4FJ0.000	1	0.048 kg
 <p>Illuminated pushbutton actuator, Momentary, Front dimension Ø 38 mm</p>						
white	Metal sandgrey	Plastic colourless transparent	B	45-2231.4FK0.000	1	0.048 kg

45 Flush design

LED colour	Front ring	Lens	Switching action	Part No.	Wiring diagram	Weight
	Illuminated pushbutton actuator, Maintain, Front dimension Ø 38 mm					
red	Metal sandgrey	Plastic red transparent	C	45-2234.4FE0.000	2	0.048 kg
	Illuminated pushbutton actuator, Maintain, Front dimension Ø 38 mm					
yellow	Metal sandgrey	Plastic yellow transparent	C	45-2234.4FG0.000	2	0.048 kg
	Illuminated pushbutton actuator, Maintain, Front dimension Ø 38 mm					
green	Metal sandgrey	Plastic green transparent	C	45-2234.4FH0.000	2	0.048 kg
	Illuminated pushbutton actuator, Maintain, Front dimension Ø 38 mm					
blue	Metal sandgrey	Plastic blue transparent	C	45-2234.4FJ0.000	2	0.048 kg
	Illuminated pushbutton actuator, Maintain, Front dimension Ø 38 mm					
white	Metal sandgrey	Plastic colourless transparent	C	45-2234.4FK0.000	2	0.048 kg

Switching action: B = Momentary, C = Maintain

	
Wiring diagram 1	Wiring diagram 2

Keylock switch 2 and 3 positions, IP66, IP67, IP69K

Equipment consisting of (schematic overview)



Actuator



Holder

page 130



Switching element

page 132

Each Part Number listed below includes all the black components shown in the 3D-drawing.

To obtain a complete unit, please select the red components from the pages shown.



Dimensions [mm]



Product can differ from the current configuration.





Mounting cut-outs [mm]

Additional Information

- Mounting depth incl. front plate, see chapter «drawings»
- Front panel thickness 1 ... 6 mm
- The standard lock: RONIS, T254
- Two keys are supplied with each key lock switch



Switching positions (A = Rest, B = Momentary, C = Maintained)

Front ring	Switching action	Switching angle	Key remove	Part No.	Wiring diagram	Weight
 <p>Keylock switch 2 positions, Front dimension Ø 38 mm</p>						
Metal sandgrey	A - B	B = 45°	A	45-290J.4F00.116	1	0.090 kg
	A - C	C = 90°	A + C	45-290H.4F00.111	2	0.090 kg
			A	45-290J.4F00.111	2	0.090 kg
 <p>Keylock switch 3 positions, Front dimension Ø 38 mm</p>						
Metal sandgrey	C - A - C	C = 45°	C - A - C	45-290F.4F00.113	3	0.090 kg

Switching action: A = Rest, B = Momentary, C = Maintain



Wiring diagram 1

Wiring diagram 2

Wiring diagram 3

45 Flush design

Selector switch actuator 2 positions short lever, IP66, IP67, IP69K



Product can differ from the current configuration.



Dimensions [mm]

Additional Information

- It is advisable to choose a white illumination
- Mounting depth incl. front plate, see chapter «drawings»
- Front panel thickness 1 ... 6 mm
- Illumination elements are optional



Mounting cut-outs [mm]

Equipment consisting of (schematic overview)



Actuator



Holder

page 130



Switching element

page 132



Illumination element

page 134

Each Part Number listed below includes all the black components shown in the 3D-drawing.

To obtain a complete unit, please select the red components from the pages shown.



Switching positions (A = Rest, B = Momentary, C = Maintained)

Lever	Front ring	Switching action	Switching angle	Part No.	Wiring diagram	Weight
	Selector switch actuator 2 positions, short lever, Front dimension Ø 38 mm					
Plastic red	Metal sandgrey	A - B	B = 45°	45-2844.4C20.006	1	0.055 kg
	Selector switch actuator 2 positions, short lever, Front dimension Ø 38 mm					
Plastic green	Metal sandgrey	A - B	B = 45°	45-2844.4C50.006	1	0.055 kg
	Selector switch actuator 2 positions, short lever, Front dimension Ø 38 mm					
Plastic white	Metal sandgrey	A - B	B = 45°	45-2844.4C90.006	1	0.055 kg
	Selector switch actuator 2 positions, short lever, Front dimension Ø 38 mm					
Plastic red	Metal sandgrey	A - C	C = 90°	45-2828.4C20.001	2	0.055 kg

Lever	Front ring	Switching action	Switching angle	Part No.	Wiring diagram	Weight
 <p>Selector switch actuator 2 positions, short lever, Front dimension Ø 38 mm</p>						
Plastic green	Metal sandgrey	A - C	C = 90°	45-2828.4C50.001	2	0.055 kg
 <p>Selector switch actuator 2 positions, short lever, Front dimension Ø 38 mm</p>						
Plastic white	Metal sandgrey	A - C	C = 90°	45-2828.4C90.001	2	0.055 kg

Switching action: A = Rest, B = Momentary, C = Maintain



45 Flush design

Selector switch 2 positions long lever, IP66, IP67, IP69K



Product can differ from the current configuration.



Dimensions [mm]

Additional Information

- It is advisable to choose a white illumination
- Mounting depth incl. front plate, see chapter «drawings»
- Front panel thickness 1 ... 6 mm
- Illumination elements are optional



Mounting cut-outs [mm]

Equipment consisting of (schematic overview)



Actuator



Holder

page 130

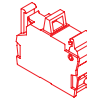

Switching element

page 132

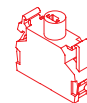

Illumination element

page 134

Each Part Number listed below includes all the black components shown in the 3D-drawing.

To obtain a complete unit, please select the red components from the pages shown.



Switching positions (A = Rest, B = Momentary, C = Maintained)

Lever	Front ring	Switching action	Switching angle	Part No.	Wiring diagram	Weight
	Selector switch actuator 2 positions, long lever, Front dimension Ø 38 mm					
Plastic red	Metal sandgrey	A - B	B = 45°	45-2844.4D20.006	1	0.055 kg
	Selector switch actuator 2 positions, long lever, Front dimension Ø 38 mm					
Plastic green	Metal sandgrey	A - B	B = 45°	45-2844.4D50.006	1	0.055 kg
	Selector switch actuator 2 positions, long lever, Front dimension Ø 38 mm					
Plastic white	Metal sandgrey	A - B	B = 45°	45-2844.4D90.006	1	0.055 kg
	Selector switch actuator 2 positions, long lever, Front dimension Ø 38 mm					
Plastic red	Metal sandgrey	A - C	C = 90°	45-2828.4D20.001	2	0.055 kg

Lever	Front ring	Switching action	Switching angle	Part No.	Wiring diagram	Weight
 <p>Selector switch actuator 2 positions, long lever, Front dimension Ø 38 mm</p>						
Plastic green	Metal sandgrey	A - C	C = 90°	45-2828.4D50.001	2	0.055 kg
 <p>Selector switch actuator 2 positions, long lever, Front dimension Ø 38 mm</p>						
Plastic white	Metal sandgrey	A - C	C = 90°	45-2828.4D90.001	2	0.055 kg

Switching action: A = Rest, B = Momentary, C = Maintain



45 Flush design

Selector switch 3 positions short lever, IP66, IP67, IP69K



Product can differ from the current configuration.



Dimensions [mm]

Additional Information

- It is advisable to choose a white illumination
- Mounting depth incl. front plate, see chapter «drawings»
- Front panel thickness 1 ... 6 mm
- Illumination elements are optional



Mounting cut-outs [mm]

Equipment consisting of (schematic overview)



Actuator



Holder

page 130



Switching element

page 132



Illumination element





page 134

Each Part Number listed below includes all the black components shown in the 3D-drawing.

To obtain a complete unit, please select the red components from the pages shown.



Switching positions (A = Rest, B = Momentary, C = Maintained)

Lever	Front ring	Switching action	Switching angle	Part No.	Wiring diagram	Weight
	Selector switch actuator 3 positions, short lever, Front dimension Ø 38 mm					
Plastic red	Metal sandgrey	C - A - C	C = 45°	45-2819.4C20.003	1	0.055 kg
	Selector switch actuator 3 positions, short lever, Front dimension Ø 38 mm					
Plastic green	Metal sandgrey	C - A - C	C = 45°	45-2819.4C50.003	1	0.055 kg
	Selector switch actuator 3 positions, short lever, Front dimension Ø 38 mm					
Plastic white	Metal sandgrey	C - A - C	C = 45°	45-2819.4C90.003	1	0.055 kg
	Selector switch actuator 3 positions, short lever, Front dimension Ø 38 mm					
Plastic red	Metal sandgrey	B - A - B	B = 45°	45-280S.4C20.003	2	0.055 kg

Lever	Front ring	Switching action	Switching angle	Part No.	Wiring diagram	Weight
 <p>Selector switch actuator 3 positions, short lever, Front dimension Ø 38 mm</p>						
Plastic green	Metal sandgrey	B - A - B	B = 45°	45-280S.4C50.003	2	0.055 kg
 <p>Selector switch actuator 3 positions, short lever, Front dimension Ø 38 mm</p>						
Plastic white	Metal sandgrey	B - A - B	B = 45°	45-280S.4C90.003	2	0.055 kg

Switching action: A = Rest, B = Momentary, C = Maintain



45 Flush design

Selector switch 3 positions long lever, IP66, IP67, IP69K



Product can differ from the current configuration.



Dimensions [mm]

Additional Information

- It is advisable to choose a white illumination
- Mounting depth incl. front plate, see chapter «drawings»
- Front panel thickness 1 ... 6 mm
- Illumination elements are optional



Mounting cut-outs [mm]

Equipment consisting of (schematic overview)



Actuator



Holder

page 130



Switching element

page 132



Illumination element

page 134

Each Part Number listed below includes all the black components shown in the 3D-drawing.

To obtain a complete unit, please select the red components from the pages shown.



Switching positions (A = Rest, B = Momentary, C = Maintained)

Lever	Front ring	Switching action	Switching angle	Part No.	Wiring diagram	Weight
	Selector switch actuator 3 positions, long lever, Front dimension Ø 38 mm					
Plastic red	Metal sandgrey	C - A - C	C = 45°	45-2819.4D20.003	1	0.055 kg
	Selector switch actuator 3 positions, long lever, Front dimension Ø 38 mm					
Plastic green	Metal sandgrey	C - A - C	C = 45°	45-2819.4D50.003	1	0.055 kg
	Selector switch actuator 3 positions, long lever, Front dimension Ø 38 mm					
Plastic white	Metal sandgrey	C - A - C	C = 45°	45-2819.4D90.003	1	0.055 kg
	Selector switch actuator 3 positions, long lever, Front dimension Ø 38 mm					
Plastic red	Metal sandgrey	B - A - B	B = 45°	45-280S.4D20.003	2	0.055 kg

Lever	Front ring	Switching action	Switching angle	Part No.	Wiring diagram	Weight
 <p>Selector switch actuator 3 positions, long lever, Front dimension Ø 38 mm</p>						
Plastic green	Metal sandgrey	B - A - B	B = 45°	45-280S.4D50.003	2	0.055 kg
 <p>Selector switch actuator 3 positions, long lever, Front dimension Ø 38 mm</p>						
Plastic white	Metal sandgrey	B - A - B	B = 45°	45-280S.4D90.003	2	0.055 kg

Switching action: A = Rest, B = Momentary, C = Maintain



45 Raised design

Indicator full face illumination, IP66, IP67, IP69K



Product can differ from the current configuration.



Dimensions [mm]

Additional Information

- Mounting depth incl. front plate, see chapter «drawings»





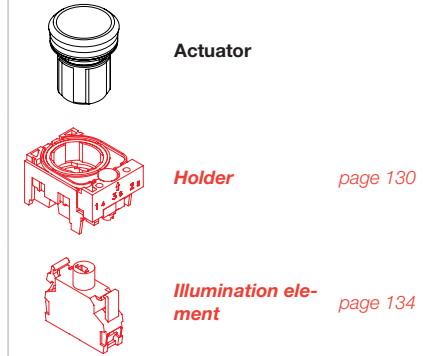

Mounting cut-outs [mm]

Equipment consisting of (schematic overview)



Each Part Number listed below includes all the black components shown in the 3D-drawing.

To obtain a complete unit, please select the red components from the pages shown.

LED colour	Housing material	Lens cap	Part No.	Weight
	Indicator actuator, Front dimension Ø 29.45 mm			
amber	Plastic	Plastic amber transparency	45-2T00.10F0.000	0.001 kg
	Indicator actuator, Front dimension Ø 29.45 mm			
red	Plastic	Plastic red transparent	45-2T00.10E0.000	0.001 kg
	Indicator actuator, Front dimension Ø 29.45 mm			
yellow	Plastic	Plastic yellow transparent	45-2T00.10G0.000	0.001 kg
	Indicator actuator, Front dimension Ø 29.45 mm			
green	Plastic	Plastic green transparent	45-2T00.10H0.000	0.001 kg
	Indicator actuator, Front dimension Ø 29.45 mm			
blue	Plastic	Plastic blue transparent	45-2T00.10J0.000	0.001 kg

LED colour	Housing material	Lens cap	Part No.	Weight
	Indicator actuator, Front dimension Ø 29.45 mm			
white	Plastic	Plastic white transparent	45-2T00.10N0.000	0.001 kg
	Indicator actuator, Front dimension Ø 29.45 mm			
colourless	Plastic	Plastic colourless transparent	45-2T00.10K0.000	0.001 kg
	Indicator actuator, Front dimension Ø 29.45 mm			
amber	Metal	Plastic amber transparency	45-2T00.20F0.000	0.010 kg
	Indicator actuator, Front dimension Ø 29.45 mm			
red	Metal	Plastic red transparent	45-2T00.20E0.000	0.010 kg
	Indicator actuator, Front dimension Ø 29.45 mm			
yellow	Metal	Plastic yellow transparent	45-2T00.20G0.000	0.010 kg
	Indicator actuator, Front dimension Ø 29.45 mm			
green	Metal	Plastic green transparent	45-2T00.20H0.000	0.010 kg
	Indicator actuator, Front dimension Ø 29.45 mm			
blue	Metal	Plastic blue transparent	45-2T00.20J0.000	0.010 kg
	Indicator actuator, Front dimension Ø 29.45 mm			
white	Metal	Plastic white transparent	45-2T00.20N0.000	0.010 kg
	Indicator actuator, Front dimension Ø 29.45 mm			
colourless	Metal	Plastic colourless transparent	45-2T00.20K0.000	0.010 kg

45 Raised design

Indicator front illumination, IP66, IP67, IP69K



Product can differ from the current configuration.



Dimensions [mm]

Equipment consisting of (schematic overview)



Actuator



Holder

page 130



Illumination element

page 134

Additional Information

- Mounting depth incl. front plate, see chapter «drawings»



Mounting cut-outs [mm]

Each Part Number listed below includes all the black components shown in the 3D-drawing.

To obtain a complete unit, please select the red components from the pages shown.

LED colour	Front ring	Lens	Housing material	Part No.	Weight
	Indicator actuator, Front dimension Ø 29.45 mm				
red	Plastic black	Plastic red transparent	Plastic	45-2T07.10E0.000	0.011 kg
	Indicator actuator, Front dimension Ø 29.45 mm				
yellow	Plastic black	Plastic yellow transparent	Plastic	45-2T07.10G0.000	0.011 kg
	Indicator actuator, Front dimension Ø 29.45 mm				
green	Plastic black	Plastic green transparent	Plastic	45-2T07.10H0.000	0.011 kg
	Indicator actuator, Front dimension Ø 29.45 mm				
blue	Plastic black	Plastic blue transparent	Plastic	45-2T07.10J0.000	0.011 kg
	Indicator actuator, Front dimension Ø 29.45 mm				
colourless	Plastic black	Plastic colourless transparent	Plastic	45-2T07.10K0.000	0.011 kg

LED colour	Front ring	Lens	Housing material	Part No.	Weight
	Indicator actuator, Front dimension Ø 29.45 mm				
red	Metal sandgrey	Plastic red transparent	Plastic	45-2T07.30E0.000	0.020 kg
	Indicator actuator, Front dimension Ø 29.45 mm				
yellow	Metal sandgrey	Plastic yellow transparent	Plastic	45-2T07.30G0.000	0.020 kg
	Indicator actuator, Front dimension Ø 29.45 mm				
green	Metal sandgrey	Plastic green transparent	Plastic	45-2T07.30H0.000	0.020 kg
	Indicator actuator, Front dimension Ø 29.45 mm				
blue	Metal sandgrey	Plastic blue transparent	Plastic	45-2T07.30J0.000	0.020 kg
	Indicator actuator, Front dimension Ø 29.45 mm				
colourless	Metal sandgrey	Plastic colourless transparent	Plastic	45-2T07.30K0.000	0.020 kg

45 Raised design

Pushbutton, IP66, IP67, IP69K



Product can differ from the current configuration.



Dimensions [mm]

Additional Information

- Mounting depth incl. front plate, see chapter «drawings»



Mounting cut-outs [mm]

Equipment consisting of (schematic overview)



Actuator



Holder

page 130



Switching element

page 132

Each Part Number listed below includes all the black components shown in the 3D-drawing.

To obtain a complete unit, please select the red components from the pages shown.

Product attribute	Front ring	Lens	Housing material	Switching action	Part No.	Wiring dia-gram	Weight
	Pushbutton actuator, Momentary, Front dimension Ø 29.45 mm						
Lens level with front ring	Plastic black	Plastic black	Plastic	B	45-2131.1110.000	1	0.013 kg
	Pushbutton actuator, Momentary, Front dimension Ø 29.45 mm						
Lens level with front ring	Plastic black	Plastic red	Plastic	B	45-2131.1120.000	1	0.013 kg
	Pushbutton actuator, Momentary, Front dimension Ø 29.45 mm						
Lens level with front ring	Plastic black	Plastic yellow	Plastic	B	45-2131.1140.000	1	0.013 kg
	Pushbutton actuator, Momentary, Front dimension Ø 29.45 mm						
Lens level with front ring	Plastic black	Plastic green	Plastic	B	45-2131.1150.000	1	0.013 kg
	Pushbutton actuator, Momentary, Front dimension Ø 29.45 mm						
Lens level with front ring	Plastic black	Plastic blue	Plastic	B	45-2131.1160.000	1	0.013 kg
	Pushbutton actuator, Momentary, Front dimension Ø 29.45 mm						
Lens level with front ring	Plastic black	Plastic grey	Plastic	B	45-2131.1180.000	1	0.013 kg
	Pushbutton actuator, Momentary, Front dimension Ø 29.45 mm						
Lens level with front ring	Plastic black	Plastic white	Plastic	B	45-2131.1190.000	1	0.013 kg
	Pushbutton actuator, Momentary, Front dimension Ø 29.45 mm						
Lens level with front ring	Plastic black	Plastic colourless	Plastic	B	45-2131.11K0.000	1	0.013 kg
	Pushbutton actuator, Maintain, Front dimension Ø 29.45 mm						
Lens level with front ring	Plastic black	Plastic black	Plastic	C	45-2134.1110.000	2	0.013 kg

45 Raised design

Product attribute	Front ring	Lens	Housing material	Switching action	Part No.	Wiring diagram	Weight
	Pushbutton actuator, Maintain, Front dimension Ø 29.45 mm						
Lens level with front ring	Plastic black	Plastic red	Plastic	C	45-2134.1120.000	2	0.013 kg
	Pushbutton actuator, Maintain, Front dimension Ø 29.45 mm						
Lens level with front ring	Plastic black	Plastic yellow	Plastic	C	45-2134.1140.000	2	0.013 kg
	Pushbutton actuator, Maintain, Front dimension Ø 29.45 mm						
Lens level with front ring	Plastic black	Plastic green	Plastic	C	45-2134.1150.000	2	0.013 kg
	Pushbutton actuator, Maintain, Front dimension Ø 29.45 mm						
Lens level with front ring	Plastic black	Plastic blue	Plastic	C	45-2134.1160.000	2	0.013 kg
	Pushbutton actuator, Maintain, Front dimension Ø 29.45 mm						
Lens level with front ring	Plastic black	Plastic white	Plastic	C	45-2134.1190.000	2	0.013 kg
	Pushbutton actuator, Momentary, Front dimension Ø 29.45 mm						
Lens level with front ring	Metal sandgrey	Plastic black	Plastic	B	45-2131.3110.000	1	0.021 kg
	Pushbutton actuator, Momentary, Front dimension Ø 29.45 mm						
Lens level with front ring	Metal sandgrey	Plastic red	Plastic	B	45-2131.3120.000	1	0.021 kg
	Pushbutton actuator, Momentary, Front dimension Ø 29.45 mm						
Lens level with front ring	Metal sandgrey	Plastic yellow	Plastic	B	45-2131.3140.000	1	0.021 kg
	Pushbutton actuator, Momentary, Front dimension Ø 29.45 mm						
Lens level with front ring	Metal sandgrey	Plastic green	Plastic	B	45-2131.3150.000	1	0.021 kg

Product attribute	Front ring	Lens	Housing material	Switching action	Part No.	Wiring dia-gram	Weight
	Pushbutton actuator, Momentary, Front dimension Ø 29.45 mm						
Lens level with front ring	Metal sandgrey	Plastic blue	Plastic	B	45-2131.3160.000	1	0.021 kg
	Pushbutton actuator, Momentary, Front dimension Ø 29.45 mm						
Lens level with front ring	Metal sandgrey	Plastic grey	Plastic	B	45-2131.3180.000	1	0.021 kg
	Pushbutton actuator, Momentary, Front dimension Ø 29.45 mm						
Lens level with front ring	Metal sandgrey	Plastic white	Plastic	B	45-2131.3190.000	1	0.021 kg
	Pushbutton actuator, Momentary, Front dimension Ø 29.45 mm						
Lens level with front ring	Metal sandgrey	Plastic colourless	Plastic	B	45-2131.31K0.000	1	0.021 kg
	Pushbutton actuator, Maintain, Front dimension Ø 29.45 mm						
Lens level with front ring	Metal sandgrey	Plastic black	Plastic	C	45-2134.3110.000	2	0.021 kg
	Pushbutton actuator, Maintain, Front dimension Ø 29.45 mm						
Lens level with front ring	Metal sandgrey	Plastic red	Plastic	C	45-2134.3120.000	2	0.021 kg
	Pushbutton actuator, Maintain, Front dimension Ø 29.45 mm						
Lens level with front ring	Metal sandgrey	Plastic yellow	Plastic	C	45-2134.3140.000	2	0.021 kg
	Pushbutton actuator, Maintain, Front dimension Ø 29.45 mm						
Lens level with front ring	Metal sandgrey	Plastic green	Plastic	C	45-2134.3150.000	2	0.021 kg
	Pushbutton actuator, Maintain, Front dimension Ø 29.45 mm						
Lens level with front ring	Metal sandgrey	Plastic blue	Plastic	C	45-2134.3160.000	2	0.021 kg

45 Raised design

Product attribute	Front ring	Lens	Housing material	Switching action	Part No.	Wiring diagram	Weight
	Pushbutton actuator, Maintain, Front dimension Ø 29.45 mm						
Lens level with front ring	Metal sandgrey	Plastic white	Plastic	C	45-2134.3190.000	2	0.021 kg
	Pushbutton actuator, Momentary, Front dimension Ø 29.45 mm						
Lens level with front ring	Metal silver	Plastic black	Metal	B	45-2131.2110.000	1	0.048 kg
	Pushbutton actuator, Momentary, Front dimension Ø 29.45 mm						
Lens level with front ring	Metal silver	Plastic red	Metal	B	45-2131.2120.000	1	0.048 kg
	Pushbutton actuator, Momentary, Front dimension Ø 29.45 mm						
Lens level with front ring	Metal silver	Plastic yellow	Metal	B	45-2131.2140.000	1	0.048 kg
	Pushbutton actuator, Momentary, Front dimension Ø 29.45 mm						
Lens level with front ring	Metal silver	Plastic green	Metal	B	45-2131.2150.000	1	0.048 kg
	Pushbutton actuator, Momentary, Front dimension Ø 29.45 mm						
Lens level with front ring	Metal silver	Plastic blue	Metal	B	45-2131.2160.000	1	0.048 kg
	Pushbutton actuator, Momentary, Front dimension Ø 29.45 mm						
Lens level with front ring	Metal silver	Plastic grey	Metal	B	45-2131.2180.000	1	0.048 kg
	Pushbutton actuator, Momentary, Front dimension Ø 29.45 mm						
Lens level with front ring	Metal silver	Plastic white	Metal	B	45-2131.2190.000	1	0.048 kg
	Pushbutton actuator, Momentary, Front dimension Ø 29.45 mm						
Lens level with front ring	Metal silver	Plastic colourless	Metal	B	45-2131.21K0.000	1	0.048 kg

Product attribute	Front ring	Lens	Housing material	Switching action	Part No.	Wiring diagram	Weight
	Pushbutton actuator, Maintain, Front dimension Ø 29.45 mm						
Lens level with front ring	Metal silver	Plastic black	Metal	C	45-2134.2110.000	2	0.048 kg
	Pushbutton actuator, Maintain, Front dimension Ø 29.45 mm						
Lens level with front ring	Metal silver	Plastic red	Metal	C	45-2134.2120.000	2	0.048 kg
	Pushbutton actuator, Maintain, Front dimension Ø 29.45 mm						
Lens level with front ring	Metal silver	Plastic yellow	Metal	C	45-2134.2140.000	2	0.048 kg
	Pushbutton actuator, Maintain, Front dimension Ø 29.45 mm						
Lens level with front ring	Metal silver	Plastic green	Metal	C	45-2134.2150.000	2	0.048 kg
	Pushbutton actuator, Maintain, Front dimension Ø 29.45 mm						
Lens level with front ring	Metal silver	Plastic blue	Metal	C	45-2134.2160.000	2	0.048 kg
	Pushbutton actuator, Maintain, Front dimension Ø 29.45 mm						
Lens level with front ring	Metal silver	Plastic white	Metal	C	45-2134.2190.000	2	0.048 kg
	Pushbutton actuator, Momentary, Front dimension Ø 29.45 mm						
Lens raised above bezel	Plastic black	Plastic black	Plastic	B	45-2131.1210.000	1	0.013 kg
	Pushbutton actuator, Momentary, Front dimension Ø 29.45 mm						
Lens raised above bezel	Plastic black	Plastic red	Plastic	B	45-2131.1220.000	1	0.013 kg
	Pushbutton actuator, Momentary, Front dimension Ø 29.45 mm						
Lens raised above bezel	Plastic black	Plastic yellow	Plastic	B	45-2131.1240.000	1	0.013 kg

45 Raised design

Product attribute	Front ring	Lens	Housing material	Switching action	Part No.	Wiring diagram	Weight
 <p>Pushbutton actuator, Momentary, Front dimension Ø 29.45 mm</p>							
Lens raised above bezel	Plastic black	Plastic green	Plastic	B	45-2131.1250.000	1	0.013 kg
 <p>Pushbutton actuator, Momentary, Front dimension Ø 29.45 mm</p>							
Lens raised above bezel	Plastic black	Plastic blue	Plastic	B	45-2131.1260.000	1	0.013 kg
 <p>Pushbutton actuator, Momentary, Front dimension Ø 29.45 mm</p>							
Lens raised above bezel	Plastic black	Plastic white	Plastic	B	45-2131.1290.000	1	0.013 kg
 <p>Pushbutton actuator, Momentary, Front dimension Ø 29.45 mm</p>							
Lens raised above bezel	Metal sandgrey	Plastic black	Plastic	B	45-2131.3210.000	1	0.021 kg
 <p>Pushbutton actuator, Momentary, Front dimension Ø 29.45 mm</p>							
Lens raised above bezel	Metal sandgrey	Plastic red	Plastic	B	45-2131.3220.000	1	0.021 kg
 <p>Pushbutton actuator, Momentary, Front dimension Ø 29.45 mm</p>							
Lens raised above bezel	Metal sandgrey	Plastic yellow	Plastic	B	45-2131.3240.000	1	0.021 kg
 <p>Pushbutton actuator, Momentary, Front dimension Ø 29.45 mm</p>							
Lens raised above bezel	Metal sandgrey	Plastic green	Plastic	B	45-2131.3250.000	1	0.021 kg
 <p>Pushbutton actuator, Momentary, Front dimension Ø 29.45 mm</p>							
Lens raised above bezel	Metal sandgrey	Plastic blue	Plastic	B	45-2131.3260.000	1	0.021 kg
 <p>Pushbutton actuator, Momentary, Front dimension Ø 29.45 mm</p>							
Lens raised above bezel	Metal sandgrey	Plastic white	Plastic	B	45-2131.3290.000	1	0.021 kg

Product attribute	Front ring	Lens	Housing material	Switching action	Part No.	Wiring dia-gram	Weight
	Pushbutton actuator, Momentary, Front dimension Ø 29.45 mm						
Lens raised above bezel	Metal silver	Plastic black	Metal	B	45-2131.2210.000	1	0.021 kg
	Pushbutton actuator, Momentary, Front dimension Ø 29.45 mm						
Lens raised above bezel	Metal silver	Plastic red	Metal	B	45-2131.2220.000	1	0.048 kg
	Pushbutton actuator, Momentary, Front dimension Ø 29.45 mm						
Lens raised above bezel	Metal silver	Plastic yellow	Metal	B	45-2131.2240.000	1	0.048 kg
	Pushbutton actuator, Momentary, Front dimension Ø 29.45 mm						
Lens raised above bezel	Metal silver	Plastic green	Metal	B	45-2131.2250.000	1	0.048 kg
	Pushbutton actuator, Momentary, Front dimension Ø 29.45 mm						
Lens raised above bezel	Metal silver	Plastic blue	Metal	B	45-2131.2260.000	1	0.048 kg
	Pushbutton actuator, Momentary, Front dimension Ø 29.45 mm						
Lens raised above bezel	Metal silver	Plastic white	Metal	B	45-2131.2290.000	1	0.048 kg
	Pushbutton actuator, Maintain, Front dimension Ø 29.45 mm						
Lens raised above bezel	Metal silver	Plastic red	Metal	C	45-2134.2220.000	2	0.048 kg
	Pushbutton actuator, Momentary, Front dimension Ø 29.45 mm						
Lens lower than front ring	Plastic black	Plastic black	Plastic	B	45-2131.1310.000	1	0.013 kg
	Pushbutton actuator, Momentary, Front dimension Ø 29.45 mm						
Lens lower than front ring	Plastic black	Plastic red	Plastic	B	45-2131.1320.000	1	0.013 kg

45 Raised design

Product attribute	Front ring	Lens	Housing material	Switching action	Part No.	Wiring diagram	Weight
	Pushbutton actuator, Momentary, Front dimension Ø 29.45 mm						
Lens lower than front ring	Plastic black	Plastic yellow	Plastic	B	45-2131.1340.000	1	0.013 kg
	Pushbutton actuator, Momentary, Front dimension Ø 29.45 mm						
Lens lower than front ring	Plastic black	Plastic green	Plastic	B	45-2131.1350.000	1	0.013 kg
	Pushbutton actuator, Momentary, Front dimension Ø 29.45 mm						
Lens lower than front ring	Plastic black	Plastic blue	Plastic	B	45-2131.1360.000	1	0.013 kg
	Pushbutton actuator, Momentary, Front dimension Ø 29.45 mm						
Lens lower than front ring	Plastic black	Plastic white	Plastic	B	45-2131.1390.000	1	0.013 kg
	Pushbutton actuator, Momentary, Front dimension Ø 29.45 mm						
Lens lower than front ring	Metal sandgrey	Plastic black	Plastic	B	45-2131.3310.000	1	0.021 kg
	Pushbutton actuator, Momentary, Front dimension Ø 29.45 mm						
Lens lower than front ring	Metal sandgrey	Plastic red	Plastic	B	45-2131.3320.000	1	0.021 kg
	Pushbutton actuator, Momentary, Front dimension Ø 29.45 mm						
Lens lower than front ring	Metal sandgrey	Plastic yellow	Plastic	B	45-2131.3340.000	1	0.021 kg
	Pushbutton actuator, Momentary, Front dimension Ø 29.45 mm						
Lens lower than front ring	Metal sandgrey	Plastic green	Plastic	B	45-2131.3350.000	1	0.021 kg
	Pushbutton actuator, Momentary, Front dimension Ø 29.45 mm						
Lens lower than front ring	Metal sandgrey	Plastic blue	Plastic	B	45-2131.3360.000	1	0.021 kg

Product attribute	Front ring	Lens	Housing material	Switching action	Part No.	Wiring diagram	Weight
	Pushbutton actuator, Momentary, Front dimension Ø 29.45 mm						
Lens lower than front ring	Metal sandgrey	Plastic white	Plastic	B	45-2131.3390.000	1	0.021 kg
	Pushbutton actuator, Momentary, Front dimension Ø 29.45 mm						
Lens lower than front ring	Metal silver	Plastic black	Metal	B	45-2131.2310.000	1	0.048 kg
	Pushbutton actuator, Momentary, Front dimension Ø 29.45 mm						
Lens lower than front ring	Metal silver	Plastic red	Metal	B	45-2131.2320.000	1	0.048 kg
	Pushbutton actuator, Momentary, Front dimension Ø 29.45 mm						
Lens lower than front ring	Metal silver	Plastic yellow	Metal	B	45-2131.2340.000	1	0.048 kg
	Pushbutton actuator, Momentary, Front dimension Ø 29.45 mm						
Lens lower than front ring	Metal silver	Plastic green	Metal	B	45-2131.2350.000	1	0.048 kg
	Pushbutton actuator, Momentary, Front dimension Ø 29.45 mm						
Lens lower than front ring	Metal silver	Plastic blue	Metal	B	45-2131.2360.000	1	0.048 kg
	Pushbutton actuator, Momentary, Front dimension Ø 29.45 mm						
Lens lower than front ring	Metal silver	Plastic white	Metal	B	45-2131.2390.000	1	0.048 kg
	Pushbutton actuator, Momentary, Front dimension Ø 29.45 mm						
Lens lower than front ring, with castellation	Plastic black	Plastic black	Plastic	B	45-2131.1410.000	1	0.013 kg
	Pushbutton actuator, Momentary, Front dimension Ø 29.45 mm						
Lens lower than front ring, with castellation	Plastic black	Plastic red	Plastic	B	45-2131.1420.000	1	0.013 kg

45 Raised design

Product attribute	Front ring	Lens	Housing material	Switching action	Part No.	Wiring diagram	Weight
 <p>Pushbutton actuator, Momentary, Front dimension Ø 29.45 mm</p>							
Lens lower than front ring, with castellation	Plastic black	Plastic yellow	Plastic	B	45-2131.1440.000	1	0.013 kg
 <p>Pushbutton actuator, Momentary, Front dimension Ø 29.45 mm</p>							
Lens lower than front ring, with castellation	Plastic black	Plastic green	Plastic	B	45-2131.1450.000	1	0.013 kg
 <p>Pushbutton actuator, Momentary, Front dimension Ø 29.45 mm</p>							
Lens lower than front ring, with castellation	Plastic black	Plastic blue	Plastic	B	45-2131.1460.000	1	0.013 kg
 <p>Pushbutton actuator, Momentary, Front dimension Ø 29.45 mm</p>							
Lens lower than front ring, with castellation	Plastic black	Plastic white	Plastic	B	45-2131.1490.000	1	0.013 kg

Switching action: B = Momentary, C = Maintain

E---	E~--
Wiring diagram 1	Wiring diagram 2

Double pushbutton, IP66, IP67, IP69K

Equipment consisting of (schematic overview)



Actuator



Holder

page 130



Switching element

page 132

Each Part Number listed below includes all the black components shown in the 3D-drawing.

To obtain a complete unit, please select the red components from the pages shown.



Dimensions [mm]



Product can differ from the current configuration.



Mounting cut-outs [mm]

Additional Information

- Mounting depth incl. front plate, see chapter «drawings»

Product attribute	Front ring	Lens	Switching action	Part No.	Wiring diagram	Weight
						
Double pushbutton actuator, momentary, Front dimension 57.7 x 29.8 mm						
2 lenses, level with front ring	Plastic black	Plastic green-red	B	45-2J31.16T0.000	1	0.026 kg
						
Double pushbutton actuator, momentary, Front dimension 57.7 x 29.8 mm						
2 lenses, level with front ring	Plastic black	Plastic white-black	B	45-2J31.16V0.000	1	0.026 kg
						
Double pushbutton actuator, momentary, Front dimension 57.7 x 29.8 mm						
2 lenses, level with/raised above front ring	Plastic black	Plastic green-red	B	45-2J31.15T0.000	1	0.026 kg

45 Raised design

Product attribute	Front ring	Lens	Switching action	Part No.	Wiring diagram	Weight
	Double pushbutton actuator, momentary, Front dimension 57.7 x 29.8 mm					
2 lenses, level with/raised above front ring	Plastic black	Plastic white-black	B	45-2J31.15V0.000	1	0.026 kg
	Double pushbutton actuator, momentary, Front dimension 57.7 x 29.8 mm					
2 lenses, level with front ring	Metal sandgrey	Plastic green-red	B	45-2J31.36T0.000	1	0.043 kg
	Double pushbutton actuator, momentary, Front dimension 57.7 x 29.8 mm					
2 lenses, level with front ring	Metal sandgrey	Plastic white-black	B	45-2J31.36V0.000	1	0.043 kg
	Double pushbutton actuator, momentary, Front dimension 57.7 x 29.8 mm					
2 lenses, level with/raised above front ring	Metal sandgrey	Plastic green-red	B	45-2J31.35T0.000	1	0.043 kg
	Double pushbutton actuator, momentary, Front dimension 57.7 x 29.8 mm					
2 lenses, level with front ring	Metal silver	Plastic green-red	B	45-2J31.26T0.000	1	0.068 kg
	Double pushbutton actuator, momentary, Front dimension 57.7 x 29.8 mm					
2 lenses, level with front ring	Metal silver	Plastic white-black	B	45-2J31.26V0.000	1	0.068 kg
	Double pushbutton actuator, momentary, Front dimension 57.7 x 29.8 mm					
2 lenses, level with/raised above front ring	Metal silver	Plastic green-red	B	45-2J31.25T0.000	1	0.068 kg
	Double pushbutton actuator, momentary, Front dimension 57.7 x 29.8 mm					
2 lenses, level with/raised above front ring	Metal silver	Plastic white-black	B	45-2J31.25V0.000	1	0.068 kg

Switching action: B = Momentary



Illuminated pushbutton, IP66, IP67, IP69K

Equipment consisting of (schematic overview)



Each Part Number listed below includes all the black components shown in the 3D-drawing.

To obtain a complete unit, please select the red components from the pages shown.



Dimensions [mm]



Mounting cut-outs [mm]



Product can differ from the current configuration.

Additional Information

- Mounting depth incl. front plate, see chapter «drawings»

Product attribute	Front ring	Lens	Housing material	Switching action	Part No.	Wiring diagram	Weight
	Illuminated pushbutton actuator, Momentary, Front dimension Ø 29.45 mm						
Lens level with front ring	Plastic black	Plastic amber transparency	Plastic	B	45-2231.11F0.000	1	0.011 kg
	Illuminated pushbutton actuator, Momentary, Front dimension Ø 29.45 mm						
Lens level with front ring	Plastic black	Plastic red transparent	Plastic	B	45-2231.11E0.000	1	0.011 kg

45 Raised design

Product attribute	Front ring	Lens	Housing material	Switching action	Part No.	Wiring diagram	Weight
	Illuminated pushbutton actuator, Momentary, Front dimension Ø 29.45 mm						
Lens level with front ring	Plastic black	Plastic yellow transparent	Plastic	B	45-2231.11G0.000	1	0.011 kg
	Illuminated pushbutton actuator, Momentary, Front dimension Ø 29.45 mm						
Lens level with front ring	Plastic black	Plastic green transparent	Plastic	B	45-2231.11H0.000	1	0.011 kg
	Illuminated pushbutton actuator, Momentary, Front dimension Ø 29.45 mm						
Lens level with front ring	Plastic black	Plastic blue transparent	Plastic	B	45-2231.11J0.000	1	0.011 kg
	Illuminated pushbutton actuator, Momentary, Front dimension Ø 29.45 mm						
Lens level with front ring	Plastic black	Plastic white transparent	Plastic	B	45-2231.11N0.000	1	0.011 kg
	Illuminated pushbutton actuator, Momentary, Front dimension Ø 29.45 mm						
Lens level with front ring	Plastic black	Plastic colourless transparent	Plastic	B	45-2231.11K0.000	1	0.011 kg
	Illuminated pushbutton actuator, Maintain, Front dimension Ø 29.45 mm						
Lens level with front ring	Plastic black	Plastic red transparent	Plastic	C	45-2234.11E0.000	2	0.011 kg
	Illuminated pushbutton actuator, Maintain, Front dimension Ø 29.45 mm						
Lens level with front ring	Plastic black	Plastic yellow transparent	Plastic	C	45-2234.11G0.000	2	0.011 kg
	Illuminated pushbutton actuator, Maintain, Front dimension Ø 29.45 mm						
Lens level with front ring	Plastic black	Plastic green transparent	Plastic	C	45-2234.11H0.000	2	0.011 kg
	Illuminated pushbutton actuator, Maintain, Front dimension Ø 29.45 mm						
Lens level with front ring	Plastic black	Plastic blue transparent	Plastic	C	45-2234.11J0.000	2	0.011 kg

Product attribute	Front ring	Lens	Housing material	Switching action	Part No.	Wiring diagram	Weight
	Illuminated pushbutton actuator, Maintain, Front dimension Ø 29.45 mm						
Lens level with front ring	Plastic black	Plastic white transparent	Plastic	C	45-2234.11N0.000	2	0.011 kg
	Illuminated pushbutton actuator, Maintain, Front dimension Ø 29.45 mm						
Lens level with front ring	Plastic black	Plastic colourless transparent	Plastic	C	45-2234.11K0.000	2	0.011 kg
	Illuminated pushbutton actuator, Momentary, Front dimension Ø 29.45 mm						
Lens level with front ring	Metal sandgrey	Plastic amber transparency	Plastic	B	45-2231.31F0.000	1	0.020 kg
	Illuminated pushbutton actuator, Momentary, Front dimension Ø 29.45 mm						
Lens level with front ring	Metal sandgrey	Plastic red transparent	Plastic	B	45-2231.31E0.000	1	0.020 kg
	Illuminated pushbutton actuator, Momentary, Front dimension Ø 29.45 mm						
Lens level with front ring	Metal sandgrey	Plastic yellow transparent	Plastic	B	45-2231.31G0.000	1	0.020 kg
	Illuminated pushbutton actuator, Momentary, Front dimension Ø 29.45 mm						
Lens level with front ring	Metal sandgrey	Plastic green transparent	Plastic	B	45-2231.31H0.000	1	0.020 kg
	Illuminated pushbutton actuator, Momentary, Front dimension Ø 29.45 mm						
Lens level with front ring	Metal sandgrey	Plastic blue transparent	Plastic	B	45-2231.31J0.000	1	0.020 kg
	Illuminated pushbutton actuator, Momentary, Front dimension Ø 29.45 mm						
Lens level with front ring	Metal sandgrey	Plastic white transparent	Plastic	B	45-2231.31N0.000	1	0.020 kg
	Illuminated pushbutton actuator, Momentary, Front dimension Ø 29.45 mm						
Lens level with front ring	Metal sandgrey	Plastic colourless transparent	Plastic	B	45-2231.31K0.000	1	0.020 kg

45 Raised design

Product attribute	Front ring	Lens	Housing material	Switching action	Part No.	Wiring diagram	Weight
	Illuminated pushbutton actuator, Maintain, Front dimension Ø 29.45 mm						
Lens level with front ring	Metal sandgrey	Plastic red transparent	Plastic	C	45-2234.31E0.000	2	0.020 kg
	Illuminated pushbutton actuator, Maintain, Front dimension Ø 29.45 mm						
Lens level with front ring	Metal sandgrey	Plastic yellow transparent	Plastic	C	45-2234.31G0.000	2	0.020 kg
	Illuminated pushbutton actuator, Maintain, Front dimension Ø 29.45 mm						
Lens level with front ring	Metal sandgrey	Plastic green transparent	Plastic	C	45-2234.31H0.000	2	0.020 kg
	Illuminated pushbutton actuator, Maintain, Front dimension Ø 29.45 mm						
Lens level with front ring	Metal sandgrey	Plastic blue transparent	Plastic	C	45-2234.31J0.000	2	0.020 kg
	Illuminated pushbutton actuator, Maintain, Front dimension Ø 29.45 mm						
Lens level with front ring	Metal sandgrey	Plastic white transparent	Plastic	C	45-2234.31N0.000	2	0.020 kg
	Illuminated pushbutton actuator, Maintain, Front dimension Ø 29.45 mm						
Lens level with front ring	Metal sandgrey	Plastic colourless transparent	Plastic	C	45-2234.31K0.000	2	0.020 kg
	Illuminated pushbutton actuator, Momentary, Front dimension Ø 29.45 mm						
Lens level with front ring	Metal silver	Plastic amber transparency	Metal	B	45-2231.21F0.000	1	0.032 kg
	Illuminated pushbutton actuator, Momentary, Front dimension Ø 29.45 mm						
Lens level with front ring	Metal silver	Plastic red transparent	Metal	B	45-2231.21E0.000	1	0.032 kg
	Illuminated pushbutton actuator, Momentary, Front dimension Ø 29.45 mm						
Lens level with front ring	Metal silver	Plastic yellow transparent	Metal	B	45-2231.21G0.000	1	0.032 kg

Product attribute	Front ring	Lens	Housing material	Switching action	Part No.	Wiring diagram	Weight
	Illuminated pushbutton actuator, Momentary, Front dimension Ø 29.45 mm						
Lens level with front ring	Metal silver	Plastic green transparent	Metal	B	45-2231.21H0.000	1	0.032 kg
	Illuminated pushbutton actuator, Momentary, Front dimension Ø 29.45 mm						
Lens level with front ring	Metal silver	Plastic blue transparent	Metal	B	45-2231.21J0.000	1	0.032 kg
	Illuminated pushbutton actuator, Momentary, Front dimension Ø 29.45 mm						
Lens level with front ring	Metal silver	Plastic white transparent	Metal	B	45-2231.21N0.000	1	0.032 kg
	Illuminated pushbutton actuator, Momentary, Front dimension Ø 29.45 mm						
Lens level with front ring	Metal silver	Plastic colourless transparent	Metal	B	45-2231.21K0.000	1	0.032 kg
	Illuminated pushbutton actuator, Maintain, Front dimension Ø 29.45 mm						
Lens level with front ring	Metal silver	Plastic red transparent	Metal	C	45-2234.21E0.000	2	0.032 kg
	Illuminated pushbutton actuator, Maintain, Front dimension Ø 29.45 mm						
Lens level with front ring	Metal silver	Plastic yellow transparent	Metal	C	45-2234.21G0.000	2	0.032 kg
	Illuminated pushbutton actuator, Maintain, Front dimension Ø 29.45 mm						
Lens level with front ring	Metal silver	Plastic green transparent	Metal	C	45-2234.21H0.000	2	0.032 kg
	Illuminated pushbutton actuator, Maintain, Front dimension Ø 29.45 mm						
Lens level with front ring	Metal silver	Plastic blue transparent	Metal	C	45-2234.21J0.000	2	0.032 kg
	Illuminated pushbutton actuator, Maintain, Front dimension Ø 29.45 mm						
Lens level with front ring	Metal silver	Plastic white transparent	Metal	C	45-2234.21N0.000	2	0.032 kg

45 Raised design

Product attribute	Front ring	Lens	Housing material	Switching action	Part No.	Wiring diagram	Weight
	Illuminated pushbutton actuator, Maintain, Front dimension Ø 29.45 mm						
Lens level with front ring	Metal silver	Plastic colourless transparent	Metal	C	45-2234.21K0.000	2	0.032 kg
	Illuminated pushbutton actuator, Momentary, Front dimension Ø 29.45 mm						
Lens raised above bezel	Plastic black	Plastic red transparent	Plastic	B	45-2231.12E0.000	1	0.011 kg
	Illuminated pushbutton actuator, Momentary, Front dimension Ø 29.45 mm						
Lens raised above bezel	Plastic black	Plastic yellow transparent	Plastic	B	45-2231.12G0.000	1	0.011 kg
	Illuminated pushbutton actuator, Momentary, Front dimension Ø 29.45 mm						
Lens raised above bezel	Plastic black	Plastic green transparent	Plastic	B	45-2231.12H0.000	1	0.011 kg
	Illuminated pushbutton actuator, Momentary, Front dimension Ø 29.45 mm						
Lens raised above bezel	Plastic black	Plastic blue transparent	Plastic	B	45-2231.12J0.000	1	0.011 kg
	Illuminated pushbutton actuator, Momentary, Front dimension Ø 29.45 mm						
Lens raised above bezel	Plastic black	Plastic colourless transparent	Plastic	B	45-2231.12K0.000	1	0.011 kg
	Illuminated pushbutton actuator, Momentary, Front dimension Ø 29.45 mm						
Lens raised above bezel	Metal sandgrey	Plastic red transparent	Plastic	B	45-2231.32E0.000	1	0.020 kg
	Illuminated pushbutton actuator, Momentary, Front dimension Ø 29.45 mm						
Lens raised above bezel	Metal sandgrey	Plastic yellow transparent	Plastic	B	45-2231.32G0.000	1	0.020 kg
	Illuminated pushbutton actuator, Momentary, Front dimension Ø 29.45 mm						
Lens raised above bezel	Metal sandgrey	Plastic green transparent	Plastic	B	45-2231.32H0.000	1	0.020 kg

Product attribute	Front ring	Lens	Housing material	Switching action	Part No.	Wiring diagram	Weight
	Illuminated pushbutton actuator, Momentary, Front dimension Ø 29.45 mm						
Lens raised above bezel	Metal sandgrey	Plastic blue transparent	Plastic	B	45-2231.32J0.000	1	0.020 kg
	Illuminated pushbutton actuator, Momentary, Front dimension Ø 29.45 mm						
Lens raised above bezel	Metal sandgrey	Plastic colourless transparent	Plastic	B	45-2231.32K0.000	1	0.020 kg
	Illuminated pushbutton actuator, Momentary, Front dimension Ø 29.45 mm						
Lens raised above bezel	Metal silver	Plastic red transparent	Metal	B	45-2231.22E0.000	1	0.032 kg
	Illuminated pushbutton actuator, Momentary, Front dimension Ø 29.45 mm						
Lens raised above bezel	Metal silver	Plastic amber transparency	Metal	B	45-2231.22F0.000	1	0.032 kg
	Illuminated pushbutton actuator, Momentary, Front dimension Ø 29.45 mm						
Lens raised above bezel	Metal silver	Plastic yellow transparent	Metal	B	45-2231.22G0.000	1	0.032 kg
	Illuminated pushbutton actuator, Momentary, Front dimension Ø 29.45 mm						
Lens raised above bezel	Metal silver	Plastic green transparent	Metal	B	45-2231.22H0.000	1	0.032 kg
	Illuminated pushbutton actuator, Momentary, Front dimension Ø 29.45 mm						
Lens raised above bezel	Metal silver	Plastic blue transparent	Metal	B	45-2231.22J0.000	1	0.032 kg
	Illuminated pushbutton actuator, Momentary, Front dimension Ø 29.45 mm						
Lens raised above bezel	Metal silver	Plastic colourless transparent	Metal	B	45-2231.22K0.000	1	0.032 kg

45 Raised design

Product attribute	Front ring	Lens	Housing material	Switching action	Part No.	Wiring diagram	Weight
 <p>Illuminated pushbutton actuator, Momentary, Front dimension Ø 29.45 mm</p>							
Lens raised above bezel	Metal silver	Plastic white transparent	Metal	B	45-2231.22N0.000	1	0.032 kg
 <p>Illuminated pushbutton actuator, Momentary, Front dimension Ø 29.45 mm</p>							
Lens lower than front ring, with castellation	Plastic black	Plastic blue transparent	Plastic	B	45-2231.14J0.000	1	0.011 kg

Switching action: B = Momentary, C = Maintain

E---	E~--
Wiring diagram 1	Wiring diagram 2

Illuminated double pushbutton, IP66, IP67, IP69K

Equipment consisting of (schematic overview)



Actuator



Holder

page 130



Switching element

page 132



Illumination element

page 134

Each Part Number listed below includes all the black components shown in the 3D-drawing.

To obtain a complete unit, please select the red components from the pages shown.



Dimensions [mm]



Product can differ from the current configuration.



Mounting cut-outs [mm]

Additional Information

- Mounting depth incl. front plate, see chapter «drawings»
- With illuminative centre window

Product attribute	Front ring	Lens	Switching action	Part No.	Component layout	Wiring diagram	Weight
	Illuminated double pushbutton actuator, Momentary, Front dimension 57.7 x 29.8 mm						
2 lenses, level with front ring	Plastic black	Plastic green-red	B	45-2K31.16T0.000	4	1	0.025 kg
	Illuminated double pushbutton actuator, Momentary, Front dimension 57.7 x 29.8 mm						
2 lenses, level with front ring	Plastic black	Plastic white-black	B	45-2K31.16V0.000	4	1	0.025 kg
	Illuminated double pushbutton actuator, Momentary, Front dimension 57.7 x 29.8 mm						
2 lenses, level with/raised above front ring	Plastic black	Plastic green-red	B	45-2K31.15T0.000	4	1	0.025 kg

45 Raised design

Product attribute	Front ring	Lens	Switching action	Part No.	Bauteile-Layout	Wiring diagram	Weight
	Illuminated double pushbutton actuator, Momentary, Front dimension 57.7 x 29.8 mm						
2 lenses, level with/raised above front ring	Plastic black	Plastic white-black	B	45-2K31.15V0.000	4	1	0.025 kg
	Illuminated double pushbutton actuator, Momentary, Front dimension 57.7 x 29.8 mm						
2 lenses, level with front ring	Metal sandgrey	Plastic green-red	B	45-2K31.36T0.000	4	1	0.043 kg
	Illuminated double pushbutton actuator, Momentary, Front dimension 57.7 x 29.8 mm						
2 lenses, level with front ring	Metal sandgrey	Plastic white-black	B	45-2K31.36V0.000	4	1	0.043 kg
	Illuminated double pushbutton actuator, Momentary, Front dimension 57.7 x 29.8 mm						
2 lenses, level with/raised above front ring	Metal sandgrey	Plastic green-red	B	45-2K31.35T0.000	4	1	0.043 kg
	Illuminated double pushbutton actuator, Momentary, Front dimension 57.7 x 29.8 mm						
2 lenses, level with/raised above front ring	Metal sandgrey	Plastic white-black	B	45-2K31.35V0.000	4	1	0.043 kg

Switching action: B = Momentary

The component layouts you will find from page 144



Emergency-stop switch foolproof, EN IEC 60947-5-5, IP66, IP67, IP69K

Equipment consisting of (schematic overview)



Each Part Number listed below includes all the black components shown in the 3D-drawing.

To obtain a complete unit, please select the red components from the pages shown.



Dimensions [mm]



Mounting cut-outs [mm]



Product can differ from the current configuration.

Additional Information

- Mounting depth incl. front plate, see chapter «drawings»
- The standard lock: RONIS, T254
- Two keys are supplied with each key lock switch

Product attribute	Front ring	Lens	Switching action	Part No.	Wiring diagram	Weight
Emergency-stop switch actuator, foolproof EN IEC 60947-5-5, Front dimension Ø 33.8 mm						
twist to release	Plastic black	Plastic red	C	45-2C36.1820.000	1	0.046 kg
Emergency-stop switch actuator, foolproof EN IEC 60947-5-5, Front dimension Ø 33.8 mm						
twist to release, illuminable	Plastic black	Plastic red	C	45-2D36.1820.000	2	0.046 kg

45 Raised design

Product attribute	Front ring	Lens	Switching action	Part No.	Wiring diagram	Weight
	Emergency-stop switch actuator, foolproof EN IEC 60947-5-5, Front dimension Ø 33.8 mm					
twist to release, illuminable	Metall silver	Plastic red	C	45-2D36.2820.000	2	0.046 kg
	Emergency-stop switch actuator, foolproof EN IEC 60947-5-5, Front dimension Ø 40 mm					
twist to release	Plastic black	Plastic red	C	45-2C36.1920.000	1	0.046 kg
	Emergency-stop switch actuator, foolproof EN IEC 60947-5-5, Front dimension Ø 40 mm					
Pull release	Plastic black	Plastic red	C	45-2C37.1920.000	1	0.046 kg
	Emergency-stop switch actuator, foolproof EN IEC 60947-5-5, Front dimension Ø 40 mm					
twist to release, illuminable	Plastic black	Plastic red	C	45-2D36.1920.000	2	0.046 kg
	Emergency-stop switch actuator, foolproof EN IEC 60947-5-5, Front dimension Ø 60 mm					
twist to release	Plastic black	Plastic red	C	45-2C36.1A20.000	1	0.056 kg
	Emergency-stop switch actuator, foolproof EN IEC 60947-5-5, Front dimension Ø 60 mm					
twist to release, illuminable	Plastic black	Plastic red	C	45-2D36.1A20.000	2	0.053 kg
	Emergency-stop switch actuator, foolproof EN IEC 60947-5-5, Front dimension Ø 40 mm					
key to release	Plastic black	Plastic red	C	45-2C35.1920.110	1	0.083 kg

Switching action: C = Maintain



Stop switch actuator, foolproof, IP66, IP67, IP69K

Equipment consisting of (schematic overview)



Each Part Number listed below includes all the black components shown in the 3D-drawing.

To obtain a complete unit, please select the red components from the pages shown.



Dimensions [mm]



Product can differ from the current configuration.



Mounting cut-outs [mm]

Additional Information

- Mounting depth incl. front plate, see chapter «drawings»

Product attribute	Front ring	Lens	Switching action	Lever	Part No.	Wiring diagram	Weight
	Stop switch actuator, foolproof, Front dimension Ø 40 mm						
twist to release	Plastic black	Plastic black	C	–	45-2736.1910.000	1	0.036 kg
	Stop switch actuator, foolproof, Front dimension Ø 40 mm						
twist to release	Plastic black	Plastic blue	C	–	45-2736.1960.000	1	0.046 kg

45 Raised design

Product attribute	Front ring	Lens	Switching action	Lever	Part No.	Wiring diagram	Weight
 <p>Stop switch actuator, foolproof, Front dimension Ø 29.5 mm</p>							
twist to release, can be latched after pressing by rotating to the right	Plastic black	–	C	Plastic black	45-2729.1010.000	1	0.018 kg
 <p>Stop switch actuator, foolproof, Front dimension Ø 29.5 mm</p>							
twist to release, can be latched after pressing by rotating to the right	Plastic black	–	C	Plastic red	45-2729.1020.000	1	0.018 kg

Switching action: C = Maintain



Mushroom-head pushbutton Ø 30 mm, IP66, IP67, IP69K

Equipment consisting of (schematic overview)



Each Part Number listed below includes all the black components shown in the 3D-drawing.

To obtain a complete unit, please select the red components from the pages shown.



Dimensions [mm]



Mounting cut-outs [mm]



Product can differ from the current configuration.

Additional Information

- Mounting depth incl. front plate, see chapter «drawings»

Front ring	Lens	Housing material	Switching action	Part No.	Wiring diagram	Weight
	Mushroom-head pushbutton actuator, Maintain, Front dimension Ø 30 mm					
Plastic black	Plastic black	Plastic	C	45-2530.1810.000	2	0.020 kg
	Mushroom-head pushbutton actuator, Maintain, Front dimension Ø 30 mm					
Plastic black	Plastic red	Plastic	C	45-2530.1820.000	2	0.020 kg
	Mushroom-head pushbutton actuator, Maintain, Front dimension Ø 30 mm					
Plastic black	Plastic yellow	Plastic	C	45-2530.1840.000	2	0.020 kg
	Mushroom-head pushbutton actuator, Momentary, Front dimension Ø 30 mm					
Plastic black	Plastic black	Plastic	B	45-2531.1810.000	1	0.020 kg
	Mushroom-head pushbutton actuator, Momentary, Front dimension Ø 30 mm					
Plastic black	Plastic red	Plastic	B	45-2531.1820.000	1	0.020 kg

45 Raised design

Front ring	Lens	Housing material	Switching action	Part No.	Wiring diagram	Weight
	Mushroom-head pushbutton actuator, Momentary, Front dimension Ø 30 mm					
Plastic black	Plastic yellow	Plastic	B	45-2531.1840.000	1	0.020 kg
	Mushroom-head pushbutton actuator, Momentary, Front dimension Ø 30 mm					
Plastic black	Plastic green	Plastic	B	45-2531.1850.000	1	0.020 kg
	Mushroom-head pushbutton actuator, Maintain, Front dimension Ø 30 mm					
Metal sandgrey	Plastic black	Plastic	C	45-2530.3810.000	2	0.034 kg
	Mushroom-head pushbutton actuator, Maintain, Front dimension Ø 30 mm					
Metal sandgrey	Plastic red	Plastic	C	45-2530.3820.000	2	0.034 kg
	Mushroom-head pushbutton actuator, Momentary, Front dimension Ø 30 mm					
Metal sandgrey	Plastic black	Plastic	B	45-2531.3810.000	1	0.034 kg
	Mushroom-head pushbutton actuator, Momentary, Front dimension Ø 30 mm					
Metal sandgrey	Plastic red	Plastic	B	45-2531.3820.000	1	0.034 kg
	Mushroom-head pushbutton actuator, Momentary, Front dimension Ø 30 mm					
Metal sandgrey	Plastic yellow	Plastic	B	45-2531.3840.000	1	0.034 kg
	Mushroom-head pushbutton actuator, Momentary, Front dimension Ø 30 mm					
Metal sandgrey	Plastic green	Plastic	B	45-2531.3850.000	1	0.034 kg
	Mushroom-head pushbutton actuator, Maintain, Front dimension Ø 30 mm					
Metal silver	Plastic black	Metal	C	45-2530.2810.000	2	0.052 kg

Front ring	Lens	Housing material	Switching action	Part No.	Wiring diagram	Weight
	Mushroom-head pushbutton actuator, Maintain, Front dimension Ø 30 mm					
Metal silver	Plastic red	Metal	C	45-2530.2820.000	2	0.052 kg
	Mushroom-head pushbutton actuator, Momentary, Front dimension Ø 30 mm					
Metal silver	Plastic black	Metal	B	45-2531.2810.000	1	0.052 kg
	Mushroom-head pushbutton actuator, Momentary, Front dimension Ø 30 mm					
Metal silver	Plastic red	Metal	B	45-2531.2820.000	1	0.052 kg
	Mushroom-head pushbutton actuator, Momentary, Front dimension Ø 30 mm					
Metal silver	Plastic yellow	Metal	B	45-2531.2840.000	1	0.052 kg
	Mushroom-head pushbutton actuator, Momentary, Front dimension Ø 30 mm					
Metal silver	Plastic green	Metal	B	45-2531.2850.000	1	0.052 kg

Switching action: B = Momentary, C = Maintain



45 Raised design

Mushroom-head pushbutton Ø 40 mm, IP66, IP67, IP69K



Product can differ from the current configuration.



Dimensions [mm]

Equipment consisting of (schematic overview)



Actuator



Holder

page 130



Switching element

page 132

Each Part Number listed below includes all the black components shown in the 3D-drawing.

To obtain a complete unit, please select the red components from the pages shown.

Additional Information

- Mounting depth incl. front plate, see chapter «drawings»



Mounting cut-outs [mm]

Front ring	Lens	Housing material	Switching action	Part No.	Wiring diagram	Weight
Mushroom-head pushbutton actuator, Maintain, Front dimension Ø 40 mm						
Plastic black	Plastic black	Plastic	C	45-2530.1910.000	2	0.022 kg
Mushroom-head pushbutton actuator, Maintain, Front dimension Ø 40 mm						
Plastic black	Plastic red	Plastic	C	45-2530.1920.000	2	0.020 kg
Mushroom-head pushbutton actuator, Maintain, Front dimension Ø 40 mm						
Plastic black	Plastic yellow	Plastic	C	45-2530.1940.000	2	0.020 kg
Mushroom-head pushbutton actuator, Maintain, Front dimension Ø 40 mm						
Plastic black	Plastic green	Plastic	C	45-2530.1950.000	2	0.020 kg

Front ring	Lens	Housing material	Switching action	Part No.	Wiring diagram	Weight
	Mushroom-head pushbutton actuator, Momentary, Front dimension Ø 40 mm					
Plastic black	Plastic black	Plastic	B	45-2531.1910.000	1	0.020 kg
	Mushroom-head pushbutton actuator, Momentary, Front dimension Ø 40 mm					
Plastic black	Plastic red	Plastic	B	45-2531.1920.000	1	0.020 kg
	Mushroom-head pushbutton actuator, Momentary, Front dimension Ø 40 mm					
Plastic black	Plastic yellow	Plastic	B	45-2531.1940.000	1	0.020 kg
	Mushroom-head pushbutton actuator, Momentary, Front dimension Ø 40 mm					
Plastic black	Plastic green	Plastic	B	45-2531.1950.000	1	0.020 kg
	Mushroom-head pushbutton actuator, Maintain, Front dimension Ø 40 mm					
Metal sandgrey	Plastic black	Plastic	C	45-2530.3910.000	2	0.034 kg
	Mushroom-head pushbutton actuator, Maintain, Front dimension Ø 40 mm					
Metal sandgrey	Plastic red	Plastic	C	45-2530.3920.000	2	0.034 kg
	Mushroom-head pushbutton actuator, Momentary, Front dimension Ø 40 mm					
Metal sandgrey	Plastic black	Plastic	B	45-2531.3910.000	1	0.034 kg
	Mushroom-head pushbutton actuator, Momentary, Front dimension Ø 40 mm					
Metal sandgrey	Plastic red	Plastic	B	45-2531.3920.000	1	0.034 kg
	Mushroom-head pushbutton actuator, Momentary, Front dimension Ø 40 mm					
Metal sandgrey	Plastic yellow	Plastic	B	45-2531.3940.000	1	0.034 kg

45 Raised design

Front ring	Lens	Housing material	Switching action	Part No.	Wiring diagram	Weight
	Mushroom-head pushbutton actuator, Momentary, Front dimension Ø 40 mm					
Metal sandgrey	Plastic green	Plastic	B	45-2531.3950.000	1	0.034 kg
	Mushroom-head pushbutton actuator, Maintain, Front dimension Ø 40 mm					
Metal silver	Plastic black	Metal	C	45-2530.2910.000	2	0.052 kg
	Mushroom-head pushbutton actuator, Maintain, Front dimension Ø 40 mm					
Metal silver	Plastic red	Metal	C	45-2530.2920.000	2	0.052 kg
	Mushroom-head pushbutton actuator, Maintain, Front dimension Ø 40 mm					
Metal silver	Plastic yellow	Metal	C	45-2530.2940.000	2	0.052 kg
	Mushroom-head pushbutton actuator, Momentary, Front dimension Ø 40 mm					
Metal silver	Plastic black	Metal	B	45-2531.2910.000	1	0.052 kg
	Mushroom-head pushbutton actuator, Momentary, Front dimension Ø 40 mm					
Metal silver	Plastic red	Metal	B	45-2531.2920.000	1	0.052 kg
	Mushroom-head pushbutton actuator, Momentary, Front dimension Ø 40 mm					
Metal silver	Plastic yellow	Metal	B	45-2531.2940.000	1	0.052 kg
	Mushroom-head pushbutton actuator, Momentary, Front dimension Ø 40 mm					
Metal silver	Plastic green	Metal	B	45-2531.2950.000	1	0.052 kg
	Mushroom-head pushbutton actuator, momentary/maintain, Front dimension Ø 40 mm					
Metal silver	Plastic black	Metal	B/C	45-2532.2910.000	3	0.052 kg

Front ring	Lens	Housing material	Switching action	Part No.	Wiring diagram	Weight
	Mushroom-head pushbutton actuator, momentary/maintain, Front dimension Ø 40 mm					
Metal silver	Plastic red	Metal	B/C	45-2532.2920.000	3	0.052 kg
	Mushroom-head pushbutton actuator, momentary/momentary, Front dimension Ø 40 mm					
Metal silver	Plastic black	Metal	B/B	45-2533.2910.000	4	0.052 kg
	Mushroom-head pushbutton actuator, momentary/momentary, Front dimension Ø 40 mm					
Metal silver	Plastic red	Metal	B/B	45-2533.2920.000	4	0.052 kg

Switching action: B = Momentary, C = Maintain, B/B = Momentary/Momentary, B/C = Momentary/Maintain

			
Wiring diagram 1	Wiring diagram 2	Wiring diagram 3	Wiring diagram 4

45 Raised design

Mushroom-head pushbutton Ø 60 mm, IP66, IP67, IP69K



Product can differ from the current configuration.



Dimensions [mm]

Equipment consisting of (schematic overview)



Actuator



Holder

page 130



Switching element

page 132

Each Part Number listed below includes all the black components shown in the 3D-drawing.

To obtain a complete unit, please select the red components from the pages shown.

Additional Information

- Mounting depth incl. front plate, see chapter «drawings»



Mounting cut-outs [mm]

Front ring	Lens	Housing material	Switching action	Part No.	Wiring diagram	Weight
						
Mushroom-head pushbutton actuator, Maintain, Front dimension Ø 60 mm						
Plastic black	Plastic black	Plastic	C	45-2530.1A10.000	2	0.022 kg
						
Mushroom-head pushbutton actuator, Maintain, Front dimension Ø 60 mm						
Plastic black	Plastic red	Plastic	C	45-2530.1A20.000	2	0.020 kg
						
Mushroom-head pushbutton actuator, Momentary, Front dimension Ø 60 mm						
Plastic black	Plastic black	Plastic	B	45-2531.1A10.000	1	0.020 kg
						
Mushroom-head pushbutton actuator, Momentary, Front dimension Ø 60 mm						
Plastic black	Plastic red	Plastic	B	45-2531.1A20.000	1	0.020 kg

Front ring	Lens	Housing material	Switching action	Part No.	Wiring diagram	Weight
	Mushroom-head pushbutton actuator, Momentary, Front dimension Ø 60 mm					
Plastic black	Plastic yellow	Plastic	B	45-2531.1A40.000	1	0.020 kg
	Mushroom-head pushbutton actuator, Momentary, Front dimension Ø 60 mm					
Plastic black	Plastic green	Plastic	B	45-2531.1A50.000	1	0.020 kg
	Mushroom-head pushbutton actuator, Maintain, Front dimension Ø 60 mm					
Metal silver	Plastic black	Metal	C	45-2530.2A10.000	2	0.052 kg
	Mushroom-head pushbutton actuator, Maintain, Front dimension Ø 60 mm					
Metal silver	Plastic red	Metal	C	45-2530.2A20.000	2	0.052 kg
	Mushroom-head pushbutton actuator, Momentary, Front dimension Ø 60 mm					
Metal silver	Plastic black	Metal	B	45-2531.2A10.000	1	0.052 kg
	Mushroom-head pushbutton actuator, Momentary, Front dimension Ø 60 mm					
Metal silver	Plastic red	Metal	B	45-2531.2A20.000	1	0.052 kg
	Mushroom-head pushbutton actuator, Momentary, Front dimension Ø 60 mm					
Metal silver	Plastic yellow	Metal	B	45-2531.2A40.000	1	0.052 kg
	Mushroom-head pushbutton actuator, Momentary, Front dimension Ø 60 mm					
Metal silver	Plastic green	Metal	B	45-2531.2A50.000	1	0.052 kg

Switching action: B = Momentary, C = Maintain



45 Raised design

Mushroom-head pushbutton Ø 30 mm, illuminated, IP66, IP67, IP69K



Product can differ from the current configuration.



Dimensions [mm]

Additional Information

- Mounting depth incl. front plate, see chapter «drawings»



Mounting cut-outs [mm]

Equipment consisting of (schematic overview)



Each Part Number listed below includes all the black components shown in the 3D-drawing.

To obtain a complete unit, please select the red components from the pages shown.

Front ring	Lens	Housing material	Switching action	Part No.	Wiring diagram	Weight
	Mushroom-head pushbutton actuator, Maintain, Front dimension Ø 30 mm					
Plastic black	Plastic red transparent	Plastic	C	45-2630.18E0.000	1	0.027 kg
	Mushroom-head pushbutton actuator, Maintain, Front dimension Ø 30 mm					
Plastic black	Plastic yellow transparent	Plastic	C	45-2630.18G0.000	1	0.027 kg
	Mushroom-head pushbutton actuator, Maintain, Front dimension Ø 30 mm					
Plastic black	Plastic green transparent	Plastic	C	45-2630.18H0.000	1	0.027 kg
	Mushroom-head pushbutton actuator, Maintain, Front dimension Ø 30 mm					
Plastic black	Plastic blue transparent	Plastic	C	45-2630.18J0.000	1	0.027 kg
	Mushroom-head pushbutton actuator, Maintain, Front dimension Ø 30 mm					
Plastic black	Plastic colourless transparent	Plastic	C	45-2630.18K0.000	1	0.027 kg

Front ring	Lens	Housing material	Switching action	Part No.	Wiring diagram	Weight
	Mushroom-head pushbutton actuator, Momentary, Front dimension Ø 30 mm					
Plastic black	Plastic red transparent	Plastic	B	45-2631.18E0.000	2	0.033 kg
	Mushroom-head pushbutton actuator, Momentary, Front dimension Ø 30 mm					
Plastic black	Plastic yellow transparent	Plastic	B	45-2631.18G0.000	2	0.033 kg
	Mushroom-head pushbutton actuator, Momentary, Front dimension Ø 30 mm					
Plastic black	Plastic green transparent	Plastic	B	45-2631.18H0.000	2	0.033 kg
	Mushroom-head pushbutton actuator, Momentary, Front dimension Ø 30 mm					
Plastic black	Plastic blue transparent	Plastic	B	45-2631.18J0.000	2	0.033 kg
	Mushroom-head pushbutton actuator, Momentary, Front dimension Ø 30 mm					
Plastic black	Plastic colourless transparent	Plastic	B	45-2631.18K0.000	2	0.033 kg
	Mushroom-head pushbutton actuator, Momentary, Front dimension Ø 30 mm					
Plastic black	Plastic white transparent	Plastic	B	45-2631.18N0.000	2	0.033 kg
	Mushroom-head pushbutton actuator, Maintain, Front dimension Ø 30 mm					
Metal sandgrey	Plastic red transparent	Plastic	C	45-2630.38E0.000	1	0.034 kg
	Mushroom-head pushbutton actuator, Maintain, Front dimension Ø 30 mm					
Metal sandgrey	Plastic yellow transparent	Plastic	C	45-2630.38G0.000	1	0.034 kg
	Mushroom-head pushbutton actuator, Momentary, Front dimension Ø 30 mm					
Metal sandgrey	Plastic yellow transparent	Plastic	B	45-2631.38G0.000	2	0.026 kg

45 Raised design

Front ring	Lens	Housing material	Switching action	Part No.	Wiring diagram	Weight
	Mushroom-head pushbutton actuator, Momentary, Front dimension Ø 30 mm					
Metal sandgrey	Plastic red transparent	Plastic	B	45-2631.38H0.000	2	0.026 kg
	Mushroom-head pushbutton actuator, Momentary, Front dimension Ø 30 mm					
Metal sandgrey	Plastic colourless transparent	Plastic	B	45-2631.38K0.000	2	0.026 kg
	Mushroom-head pushbutton actuator, Momentary, Front dimension Ø 30 mm					
Metal sandgrey	Plastic white transparent	Plastic	B	45-2631.38N0.000	2	0.026 kg
	Mushroom-head pushbutton actuator, Maintain, Front dimension Ø 30 mm					
Metal silver	Plastic amber transparency	Metal	C	45-2630.28F0.000	1	0.052 kg
	Mushroom-head pushbutton actuator, Maintain, Front dimension Ø 30 mm					
Metal silver	Plastic red transparent	Metal	C	45-2630.28E0.000	1	0.052 kg
	Mushroom-head pushbutton actuator, Maintain, Front dimension Ø 30 mm					
Metal silver	Plastic yellow transparent	Metal	C	45-2630.28G0.000	1	0.052 kg
	Mushroom-head pushbutton actuator, Maintain, Front dimension Ø 30 mm					
Metal silver	Plastic green transparent	Metal	C	45-2630.28H0.000	1	0.052 kg
	Mushroom-head pushbutton actuator, Maintain, Front dimension Ø 30 mm					
Metal silver	Plastic blue transparent	Metal	C	45-2630.28J0.000	1	0.052 kg
	Mushroom-head pushbutton actuator, Maintain, Front dimension Ø 30 mm					
Metal silver	Plastic colourless transparent	Metal	C	45-2630.28K0.000	1	0.052 kg

Front ring	Lens	Housing material	Switching action	Part No.	Wiring diagram	Weight
 <p>Mushroom-head pushbutton actuator, Momentary, Front dimension Ø 30 mm</p>						
Metal silver	Plastic yellow transparent	Metal	B	45-2631.28G0.000	2	0.041 kg
 <p>Mushroom-head pushbutton actuator, Momentary, Front dimension Ø 30 mm</p>						
Metal silver	Plastic green transparent	Metal	B	45-2631.28H0.000	2	0.041 kg
 <p>Mushroom-head pushbutton actuator, Momentary, Front dimension Ø 30 mm</p>						
Metal silver	Plastic white transparent	Metal	B	45-2631.28N0.000	2	0.041 kg

Switching action: B = Momentary, C = Maintain



45 Raised design

Mushroom-head pushbutton Ø 40 mm, illuminated, IP66, IP67, IP69K



Product can differ from the current configuration.



Dimensions [mm]

Equipment consisting of (schematic overview)



Additional Information

- Mounting depth incl. front plate, see chapter «drawings»



Mounting cut-outs [mm]

Each Part Number listed below includes all the black components shown in the 3D-drawing.

To obtain a complete unit, please select the red components from the pages shown.

Front ring	Lens	Housing material	Switching action	Part No.	Wiring diagram	Weight
	Mushroom-head pushbutton actuator, Maintain, Front dimension Ø 40 mm					
Plastic black	Plastic red transparent	Plastic	C	45-2630.19E0.000	1	0.028 kg
	Mushroom-head pushbutton actuator, Maintain, Front dimension Ø 40 mm					
Plastic black	Plastic yellow transparent	Plastic	C	45-2630.19G0.000	1	0.028 kg
	Mushroom-head pushbutton actuator, Maintain, Front dimension Ø 40 mm					
Plastic black	Plastic green transparent	Plastic	C	45-2630.19H0.000	1	0.028 kg
	Mushroom-head pushbutton actuator, Maintain, Front dimension Ø 40 mm					
Plastic black	Plastic blue transparent	Plastic	C	45-2630.19J0.000	1	0.028 kg

Front ring	Lens	Housing material	Switching action	Part No.	Wiring dia-gram	Weight
	Mushroom-head pushbutton actuator, Maintain, Front dimension Ø 40 mm					
Plastic black	Plastic colourless transparent	Plastic	C	45-2630.19K0.000	1	0.028 kg
	Mushroom-head pushbutton actuator, Momentary, Front dimension Ø 40 mm					
Plastic black	Plastic yellow transparent	Plastic	B	45-2631.19G0.000	2	0.019 kg
	Mushroom-head pushbutton actuator, Momentary, Front dimension Ø 40 mm					
Plastic black	Plastic green transparent	Plastic	B	45-2631.19H0.000	2	0.019 kg
	Mushroom-head pushbutton actuator, Momentary, Front dimension Ø 40 mm					
Plastic black	Plastic colourless transparent	Plastic	B	45-2631.19K0.000	2	0.019 kg
	Mushroom-head pushbutton actuator, Momentary, Front dimension Ø 40 mm					
Plastic black	Plastic white transparent	Plastic	B	45-2631.19N0.000	2	0.019 kg
	Mushroom-head pushbutton actuator, Maintain, Front dimension Ø 40 mm					
Metal sandgrey	Plastic red transparent	Plastic	C	45-2630.39E0.000	1	0.035 kg
	Mushroom-head pushbutton actuator, Maintain, Front dimension Ø 40 mm					
Metal sandgrey	Plastic yellow transparent	Plastic	C	45-2630.39G0.000	1	0.035 kg
	Mushroom-head pushbutton actuator, Momentary, Front dimension Ø 40 mm					
Metal sandgrey	Plastic yellow transparent	Plastic	B	45-2631.39G0.000	2	0.028 kg
	Mushroom-head pushbutton actuator, Momentary, Front dimension Ø 40 mm					
Metal sandgrey	Plastic green transparent	Plastic	B	45-2631.39H0.000	2	0.028 kg

45 Raised design

Front ring	Lens	Housing material	Switching action	Part No.	Wiring diagram	Weight
	Mushroom-head pushbutton actuator, Momentary, Front dimension Ø 40 mm					
Metal sandgrey	Plastic colourless transparent	Plastic	B	45-2631.39K0.000	2	0.028 kg
	Mushroom-head pushbutton actuator, Momentary, Front dimension Ø 40 mm					
Metal sandgrey	Plastic white transparent	Plastic	B	45-2631.39N0.000	2	0.028 kg
	Mushroom-head pushbutton actuator, Maintain, Front dimension Ø 40 mm					
Metal silver	Plastic red transparent	Metal	C	45-2630.29E0.000	1	0.035 kg
	Mushroom-head pushbutton actuator, Maintain, Front dimension Ø 40 mm					
Metal silver	Plastic amber transparency	Metal	C	45-2630.29F0.000	1	0.053 kg
	Mushroom-head pushbutton actuator, Maintain, Front dimension Ø 40 mm					
Metal silver	Plastic yellow transparent	Metal	C	45-2630.29G0.000	1	0.053 kg
	Mushroom-head pushbutton actuator, Maintain, Front dimension Ø 40 mm					
Metal silver	Plastic green transparent	Metal	C	45-2630.29H0.000	1	0.053 kg
	Mushroom-head pushbutton actuator, Maintain, Front dimension Ø 40 mm					
Metal silver	Plastic blue transparent	Metal	C	45-2630.29J0.000	1	0.053 kg
	Mushroom-head pushbutton actuator, Maintain, Front dimension Ø 40 mm					
Metal silver	Plastic colourless transparent	Metal	C	45-2630.29K0.000	1	0.053 kg
	Mushroom-head pushbutton actuator, Momentary, Front dimension Ø 40 mm					
Metal silver	Plastic amber transparency	Metal	B	45-2631.29F0.000	2	0.042 kg

Front ring	Lens	Housing material	Switching action	Part No.	Wiring diagram	Weight
	Mushroom-head pushbutton actuator, Momentary, Front dimension Ø 40 mm					
Metal silver	Plastic yellow transparent	Metal	B	45-2631.29G0.000	2	0.042 kg
	Mushroom-head pushbutton actuator, Momentary, Front dimension Ø 40 mm					
Metal silver	Plastic green transparent	Metal	B	45-2631.29H0.000	2	0.042 kg
	Mushroom-head pushbutton actuator, Momentary, Front dimension Ø 40 mm					
Metal silver	Plastic white transparent	Metal	B	45-2631.29N0.000	2	0.042 kg
	Mushroom-head pushbutton actuator, momentary/maintain, Front dimension Ø 40 mm					
Metal silver	Plastic red transparent	Metal	B/C	45-2632.29E0.000	3	0.051 kg
	Mushroom-head pushbutton actuator, momentary/maintain, Front dimension Ø 40 mm					
Metal silver	Plastic green transparent	Metal	B/C	45-2632.29H0.000	3	0.051 kg
	Mushroom-head pushbutton actuator, momentary/momentary, Front dimension Ø 40 mm					
Metal silver	Plastic red transparent	Metal	B/B	45-2633.29E0.000	4	0.051 kg
	Mushroom-head pushbutton actuator, momentary/momentary, Front dimension Ø 40 mm					
Metal silver	Plastic white transparent	Metal	B/B	45-2633.29N0.000	4	0.051 kg

Switching action: B = Momentary, C = Maintain, B/B = Momentary/Momentary, B/C = Momentary/Maintain



45 Raised design

Mushroom-head pushbutton Ø 60 mm, illuminated, IP66, IP67, IP69K



Product can differ from the current configuration.



Dimensions [mm]

Equipment consisting of (schematic overview)



Each Part Number listed below includes all the black components shown in the 3D-drawing.

To obtain a complete unit, please select the red components from the pages shown.

Additional Information

- Mounting depth incl. front plate, see chapter «drawings»



Mounting cut-outs [mm]

Front ring	Lens	Housing material	Switching action	Part No.	Wiring diagram	Weight
	Mushroom-head pushbutton actuator, Maintain, Front dimension Ø 60 mm					
Metal silver	Plastic red transparent	Metal	C	45-2630.2AE0.000	1	0.057 kg
	Mushroom-head pushbutton actuator, Maintain, Front dimension Ø 60 mm					
Metal silver	Plastic yellow transparent	Metal	C	45-2630.2AG0.000	1	0.057 kg
	Mushroom-head pushbutton actuator, Maintain, Front dimension Ø 60 mm					
Metal silver	Plastic green transparent	Metal	C	45-2630.2AH0.000	1	0.057 kg

Front ring	Lens	Housing material	Switching action	Part No.	Wiring diagram	Weight
	Mushroom-head pushbutton actuator, Maintain, Front dimension Ø 60 mm					
Metal silver	Plastic blue transparent	Metal	C	45-2630.2AJ0.000	1	0.057 kg
	Mushroom-head pushbutton actuator, Maintain, Front dimension Ø 60 mm					
Metal silver	Plastic colourless transparent	Metal	C	45-2630.2AK0.000	1	0.057 kg
	Mushroom-head pushbutton actuator, Momentary, Front dimension Ø 60 mm					
Metal silver	Plastic amber transparency	Metal	B	45-2631.2AF0.000	2	0.045 kg
	Mushroom-head pushbutton actuator, Momentary, Front dimension Ø 60 mm					
Metal silver	Plastic yellow transparent	Metal	B	45-2631.2AG0.000	2	0.045 kg
	Mushroom-head pushbutton actuator, Momentary, Front dimension Ø 60 mm					
Metal silver	Plastic green transparent	Metal	B	45-2631.2AH0.000	2	0.045 kg
	Mushroom-head pushbutton actuator, Momentary, Front dimension Ø 60 mm					
Metal silver	Plastic white transparent	Metal	B	45-2631.2AN0.000	2	0.045 kg

Switching action: B = Momentary, C = Maintain



45 Raised design

Keylock switch 2 positions, IP66, IP67, IP69K



Product can differ from the current configuration.



Dimensions [mm]

Additional Information

- Mounting depth incl. front plate, see chapter «drawings»
- The standard lock: RONIS, T254
- Two keys are supplied with each key lock switch



Mounting cut-outs [mm]

Equipment consisting of (schematic overview)



Each Part Number listed below includes all the black components shown in the 3D-drawing.

To obtain a complete unit, please select the red components from the pages shown.



Switching positions (A = Rest, B = Momentary, C = Maintained)

Front ring	Housing material	Switching action	Switching angle	Key remove	Part No.	Wiring diagram	Weight
 <p>Keylock switch actuator 2 positions, Front dimension Ø 29.45 mm</p>							
Plastic black	Plastic	A - B	B = 45°	A	45-290K.1000.116	1	0.046 kg
		A - C	C = 90°	A	45-290J.1000.111	2	0.046 kg
		A - C	C = 90°	A + C	45-290H.1000.111	2	0.046 kg
		A - C	C = 90°	A	45-2925.1000.111	2	0.046 kg
 <p>Keylock switch actuator 2 positions, Front dimension Ø 29.45 mm</p>							
Metal sandgrey	Plastic	A - B	B = 45°	A	45-290K.3000.116	1	0.061 kg
		A - C	C = 90°	A	45-290J.3000.111	2	0.061 kg
		A - C	C = 90°	A + C	45-290H.3000.111	2	0.061 kg
		A - C	C = 90°	A	45-2925.3000.111	2	0.061 kg

Front ring	Housing material	Switching action	Switching angle	Key remove	Part No.	Wiring diagram	Weight
 <p>Keylock switch actuator 2 positions, Front dimension Ø 29.45 mm</p>							
Metal silver	Metal	A - B	B = 45°	A	45-290K.2000.116	1	0.080 kg
		A - C	C = 90°	A	45-290J.2000.111	2	0.080 kg
		A - C	C = 90°	A + C	45-290H.2000.111	2	0.080 kg
		A - C	C = 90°	A	45-2925.2000.111	2	0.080 kg

Switching action: A = Rest, B = Momentary, C = Maintain



45 Raised design

Keylock switch 3 positions, IP66, IP67, IP69K



Product can differ from the current configuration.



Additional Information

- Mounting depth incl. front plate, see chapter «drawings»
- The standard lock: RONIS, T254
- Two keys are supplied with each key lock switch



Equipment consisting of (schematic overview)



Each Part Number listed below includes all the black components shown in the 3D-drawing.

To obtain a complete unit, please select the red components from the pages shown.



Switching positions (A = Rest, B = Momentary, C = Maintained)

Front ring	Switching action	Switching angle	Key remove	Part No.	Wiring diagram	Weight
<p>Keylock switch actuator 3 positions, Front dimension Ø 29.45 mm</p>	C - A - C	C = 45°	A	45-2924.1000.113	1	0.060 kg
		C = 45°	C + A + C	45-290F.1000.113	1	0.060 kg
		C = 45°	C - -	45-290D.1000.113	1	0.060 kg
		C = 45°	- - C	45-2917.1000.113	1	0.060 kg
		C = 45°	C + C	45-290C.1000.113	1	0.060 kg
		C = 45°	C + A	45-290G.1000.113	1	0.060 kg
	B - A - B	B = 45°	A	45-290Z.1000.113	2	0.060 kg
	C - A - B	C = 45°, B = 45°	A	45-2922.1000.113	3	0.060 kg
			C	45-290A.1000.113	3	0.060 kg
			C + A	45-290E.1000.113	3	0.060 kg
	B - A - C	B = 45°, C = 45°	A	45-2911.1000.113	4	0.060 kg
			C	45-290W.1000.113	4	0.060 kg
			A + C	45-2910.1000.113	4	0.060 kg

Front ring	Switching action	Switching angle	Key remove	Part No.	Wiring diagram	Weight
 <p>Keylock switch actuator 3 positions, Front dimension Ø 29.45 mm</p>						
Metal sandgrey	C - A - C	C = 45°	A	45-2924.3000.113	1	0.061 kg
		C = 45°	C + A + C	45-290F.3000.113	1	0.061 kg
		C = 45°	C - -	45-290D.3000.113	1	0.061 kg
		C = 45°	- - C	45-2917.3000.113	1	0.061 kg
		C = 45°	C + C	45-290C.3000.113	1	0.061 kg
		C = 45°	C + A	45-290G.3000.113	1	0.061 kg
	B - A - B	B = 45°	A	45-290Z.3000.113	2	0.061 kg
	C - A - B	C = 45°, B = 45°	A	45-2922.3000.113	3	0.061 kg
	B - A - C	B = 45°, C = 45°	A	45-2911.3000.113	4	0.061 kg
	 <p>Keylock switch actuator 3 positions, Front dimension Ø 29.45 mm</p>					
Metal silver	C - A - C	C = 45°	A	45-2924.2000.113	1	0.080 kg
		C = 45°	C + A + C	45-290F.2000.113	1	0.080 kg
		C = 45°	C - -	45-290D.2000.113	1	0.080 kg
		C = 45°	- - C	45-2917.2000.113	1	0.080 kg
		C = 45°	C + C	45-290C.2000.113	1	0.080 kg
		C = 45°	C + A	45-290G.2000.113	1	0.080 kg
	B - A - B	B = 45°	A	45-290Z.2000.113	2	0.080 kg
	C - A - B	C = 45°, B = 45°	A	45-2922.2000.113	3	0.080 kg
		C = 45°, B = 45°	C	45-290A.2000.113	3	0.080 kg
		C = 45°, B = 45°	C + A	45-290E.2000.113	3	0.080 kg
	B - A - C	B = 45°, C = 45°	A	45-2911.2000.113	4	0.080 kg
		B = 45°, C = 45°	A + C	45-2910.2000.113	4	0.080 kg

Switching action: A = Rest, B = Momentary, C = Maintain



45 Raised design

Selector switch actuator 2 positions round lever, IP66, IP67, IP69K



Product can differ from the current configuration.



Dimensions [mm]

Additional Information

- Mounting depth incl. front plate, see chapter «drawings»



Mounting cut-outs [mm]

Equipment consisting of (schematic overview)



Each Part Number listed below includes all the black components shown in the 3D-drawing.

To obtain a complete unit, please select the red components from the pages shown.



Switching positions (A = Rest, B = Momentary, C = Maintained)

Lever	Front ring	Housing material	Switching action	Switching angle	Part No.	Wiring diagram	Weight
	Selector switch actuator 2 positions, round lever, Front dimension Ø 29.45 mm						
Plastic red	Plastic black	Plastic	A - C	C = 90°	45-2828.1E20.001	1	0.023 kg
	Selector switch actuator 2 positions, round lever, Front dimension Ø 29.45 mm						
Plastic white	Plastic black	Plastic	A - C	C = 90°	45-2828.1E90.001	1	0.023 kg
	Selector switch actuator 2 positions, round lever, Front dimension Ø 29.45 mm						
Plastic red	Metal sandgrey	Plastic	A - C	C = 90°	45-2828.3E20.001	1	0.023 kg
	Selector switch actuator 2 positions, round lever, Front dimension Ø 29.45 mm						
Plastic white	Metal sandgrey	Plastic	A - C	C = 90°	45-2828.3E90.001	1	0.023 kg

Switching action: A = Rest, C = Maintain



45 Raised design

Selector switch actuator 2 positions short lever, IP66, IP67, IP69K



Product can differ from the current configuration.



Dimensions [mm]

Additional Information

- Mounting depth incl. front plate, see chapter «drawings»
- External diameter of the short lever 32.3 mm



Mounting cut-outs [mm]

Equipment consisting of (schematic overview)



Each Part Number listed below includes all the black components shown in the 3D-drawing.

To obtain a complete unit, please select the red components from the pages shown.



Switching positions (A = Rest, B = Momentary, C = Maintained)

Lever	Front ring	Housing material	Switching action	Switching angle	Part No.	Wiring diagram	Weight
	Selector switch actuator 2 positions, short lever, Front dimension Ø 29.45 mm						
Plastic red	Plastic black	Plastic	A - B	B = 45°	45-2844.1C20.006	1	0.022 kg
	Selector switch actuator 2 positions, short lever, Front dimension Ø 29.45 mm						
Plastic yellow	Plastic black	Plastic	A - B	B = 45°	45-2844.1C40.006	1	0.022 kg
	Selector switch actuator 2 positions, short lever, Front dimension Ø 29.45 mm						
Plastic green	Plastic black	Plastic	A - B	B = 45°	45-2844.1C50.006	1	0.022 kg
	Selector switch actuator 2 positions, short lever, Front dimension Ø 29.45 mm						
Plastic blue	Plastic black	Plastic	A - B	B = 45°	45-2844.1C60.006	1	0.022 kg

Lever	Front ring	Housing material	Switching action	Switching angle	Part No.	Wiring diagram	Weight
	Selector switch actuator 2 positions, short lever, Front dimension Ø 29.45 mm						
Plastic white	Plastic black	Plastic	A - B	B = 45°	45-2844.1C90.006	1	0.022 kg
	Selector switch actuator 2 positions, short lever, Front dimension Ø 29.45 mm						
Plastic red	Metal sandgrey	Plastic	A - B	B = 45°	45-2844.3C20.006	1	0.029 kg
	Selector switch actuator 2 positions, short lever, Front dimension Ø 29.45 mm						
Plastic yellow	Metal sandgrey	Plastic	A - B	B = 45°	45-2844.3C40.006	1	0.029 kg
	Selector switch actuator 2 positions, short lever, Front dimension Ø 29.45 mm						
Plastic green	Metal sandgrey	Plastic	A - B	B = 45°	45-2844.3C50.006	1	0.029 kg
	Selector switch actuator 2 positions, short lever, Front dimension Ø 29.45 mm						
Plastic blue	Metal sandgrey	Plastic	A - B	B = 45°	45-2844.3C60.006	1	0.029 kg
	Selector switch actuator 2 positions, short lever, Front dimension Ø 29.45 mm						
Plastic white	Metal sandgrey	Plastic	A - B	B = 45°	45-2844.3C90.006	1	0.029 kg
	Selector switch actuator 2 positions, short lever, Front dimension Ø 29.45 mm						
Plastic red	Metal silver	Metal	A - B	B = 45°	45-2844.2C20.006	1	0.044 kg
	Selector switch actuator 2 positions, short lever, Front dimension Ø 29.45 mm						
Plastic yellow	Metal silver	Metal	A - B	B = 45°	45-2844.2C40.006	1	0.044 kg
	Selector switch actuator 2 positions, short lever, Front dimension Ø 29.45 mm						
Plastic green	Metal silver	Metal	A - B	B = 45°	45-2844.2C50.006	1	0.044 kg

45 Raised design

Lever	Front ring	Housing material	Switching action	Switching angle	Part No.	Wiring diagram	Weight
	Selector switch actuator 2 positions, short lever, Front dimension Ø 29.45 mm						
Plastic blue	Metal silver	Metal	A - B	B = 45°	45-2844.2C60.006	1	0.044 kg
	Selector switch actuator 2 positions, short lever, Front dimension Ø 29.45 mm						
Plastic white	Metal silver	Metal	A - B	B = 45°	45-2844.2C90.006	1	0.044 kg
	Selector switch actuator 2 positions, short lever, Front dimension Ø 29.45 mm						
Plastic red	Plastic black	Plastic	A - C	C = 90°	45-2828.1C20.001	2	0.022 kg
	Selector switch actuator 2 positions, short lever, Front dimension Ø 29.45 mm						
Plastic yellow	Plastic black	Plastic	A - C	C = 90°	45-2828.1C40.001	2	0.022 kg
	Selector switch actuator 2 positions, short lever, Front dimension Ø 29.45 mm						
Plastic green	Plastic black	Plastic	A - C	C = 90°	45-2828.1C50.001	2	0.022 kg
	Selector switch actuator 2 positions, short lever, Front dimension Ø 29.45 mm						
Plastic blue	Plastic black	Plastic	A - C	C = 90°	45-2828.1C60.001	2	0.022 kg
	Selector switch actuator 2 positions, short lever, Front dimension Ø 29.45 mm						
Plastic white	Plastic black	Plastic	A - C	C = 90°	45-2828.1C90.001	2	0.022 kg
	Selector switch actuator 2 positions, short lever, Front dimension Ø 29.45 mm						
Plastic red	Metal sandgrey	Plastic	A - C	C = 90°	45-2828.3C20.001	2	0.029 kg
	Selector switch actuator 2 positions, short lever, Front dimension Ø 29.45 mm						
Plastic yellow	Metal sandgrey	Plastic	A - C	C = 90°	45-2828.3C40.001	2	0.029 kg

Lever	Front ring	Housing material	Switching action	Switching angle	Part No.	Wiring diagram	Weight
	Selector switch actuator 2 positions, short lever, Front dimension Ø 29.45 mm						
Plastic green	Metal sandgrey	Plastic	A - C	C = 90°	45-2828.3C50.001	2	0.029 kg
	Selector switch actuator 2 positions, short lever, Front dimension Ø 29.45 mm						
Plastic blue	Metal sandgrey	Plastic	A - C	C = 90°	45-2828.3C60.001	2	0.029 kg
	Selector switch actuator 2 positions, short lever, Front dimension Ø 29.45 mm						
Plastic white	Metal sandgrey	Plastic	A - C	C = 90°	45-2828.3C90.001	2	0.029 kg
	Selector switch actuator 2 positions, short lever, Front dimension Ø 29.45 mm						
Plastic red	Metal silver	Metal	A - C	C = 90°	45-2828.2C20.001	2	0.044 kg
	Selector switch actuator 2 positions, short lever, Front dimension Ø 29.45 mm						
Plastic ambergris	Metal silver	Metal	A - C	C = 90°	45-2828.2C30.001	2	0.044 kg
	Selector switch actuator 2 positions, short lever, Front dimension Ø 29.45 mm						
Plastic green	Metal silver	Metal	A - C	C = 90°	45-2828.2C50.001	2	0.044 kg
	Selector switch actuator 2 positions, short lever, Front dimension Ø 29.45 mm						
Plastic white	Metal silver	Metal	A - C	C = 90°	45-2828.2C90.001	2	0.044 kg

Switching action: A = Rest, B = Momentary, C = Maintain



45 Raised design

Selector switch 2 positions long lever, IP66, IP67, IP69K



Product can differ from the current configuration.



Dimensions [mm]

Additional Information

- Mounting depth incl. front plate, see chapter «drawings»
- External diameter of the long lever 44.8 mm



Mounting cut-outs [mm]

Equipment consisting of (schematic overview)



Each Part Number listed below includes all the black components shown in the 3D-drawing.

To obtain a complete unit, please select the red components from the pages shown.



Switching positions (A = Rest, B = Momentary, C = Maintained)

Lever	Front ring	Housing material	Switching action	Switching angle	Part No.	Wiring diagram	Weight
	Selector switch actuator 2 positions, long lever, Front dimension Ø 29.45 mm						
Plastic red	Plastic black	Plastic	A - C	C = 90°	45-2828.1D20.001	1	0.022 kg
	Selector switch actuator 2 positions, long lever, Front dimension Ø 29.45 mm						
Plastic white	Plastic black	Plastic	A - C	C = 90°	45-2828.1D90.001	1	0.022 kg
	Selector switch actuator 2 positions, long lever, Front dimension Ø 29.45 mm						
Plastic red	Metal sandgrey	Plastic	A - C	C = 90°	45-2828.3D20.001	1	0.029 kg
	Selector switch actuator 2 positions, long lever, Front dimension Ø 29.45 mm						
Plastic white	Metal sandgrey	Plastic	A - C	C = 90°	45-2828.3D90.001	1	0.029 kg

Lever	Front ring	Housing material	Switching action	Switching angle	Part No.	Wiring diagram	Weight
	Selector switch actuator 2 positions, long lever, Front dimension Ø 29.45 mm						
Plastic red	Metal silver	Metal	A - C	C = 90°	45-2828.2D20.001	1	0.022 kg
	Selector switch actuator 2 positions, long lever, Front dimension Ø 29.45 mm						
Plastic yellow	Metal silver	Metal	A - C	C = 90°	45-2828.2D40.001	1	0.052 kg
	Selector switch actuator 2 positions, long lever, Front dimension Ø 29.45 mm						
Plastic green	Metal silver	Metal	A - C	C = 90°	45-2828.2D50.001	1	0.052 kg
	Selector switch actuator 2 positions, long lever, Front dimension Ø 29.45 mm						
Plastic blue	Metal silver	Metal	A - C	C = 90°	45-2828.2D60.001	1	0.052 kg
	Selector switch actuator 2 positions, long lever, Front dimension Ø 29.45 mm						
Plastic white	Metal silver	Metal	A - C	C = 90°	45-2828.2D90.001	1	0.052 kg
	Selector switch actuator 2 positions, long lever, Front dimension Ø 29.45 mm						
Plastic yellow	Metal silver	Metal	A - B	B = 45°	45-2844.2D40.006	2	0.044 kg
	Selector switch actuator 2 positions, long lever, Front dimension Ø 29.45 mm						
Plastic green	Metal silver	Metal	A - B	B = 45°	45-2844.2D50.006	2	0.044 kg
	Selector switch actuator 2 positions, long lever, Front dimension Ø 29.45 mm						
Plastic blue	Metal silver	Metal	A - B	B = 45°	45-2844.2D60.006	2	0.044 kg
	Selector switch actuator 2 positions, long lever, Front dimension Ø 29.45 mm						
Plastic white	Metal silver	Metal	A - B	B = 45°	45-2844.2D90.006	2	0.044 kg

Switching action: A = Rest, B = Momentary, C = Maintain

45 Raised design



Selector switch 3 positions short lever, IP66, IP67, IP69K

Equipment consisting of (schematic overview)



Each Part Number listed below includes all the black components shown in the 3D-drawing.

To obtain a complete unit, please select the red components from the pages shown.



Dimensions [mm]



Product can differ from the current configuration.



Mounting cut-outs [mm]

Additional Information

- Mounting depth incl. front plate, see chapter «drawings»
- External diameter of the short lever 32.3 mm



Switching positions (A = Rest, B = Momentary, C = Maintained)

Lever	Front ring	Housing material	Switching action	Switching angle	Part No.	Wiring diagram	Weight
	Selector switch actuator 3 positions, short lever, Front dimension Ø 29.45 mm						
Plastic red	Plastic black	Plastic	C - A - C	C = 45°	45-2819.1C20.003	1	0.022 kg
	Selector switch actuator 3 positions, short lever, Front dimension Ø 29.45 mm						
Plastic yellow	Plastic black	Plastic	C - A - C	C = 45°	45-2819.1C40.003	1	0.022 kg
	Selector switch actuator 3 positions, short lever, Front dimension Ø 29.45 mm						
Plastic green	Plastic black	Plastic	C - A - C	C = 45°	45-2819.1C50.003	1	0.022 kg
	Selector switch actuator 3 positions, short lever, Front dimension Ø 29.45 mm						
Plastic blue	Plastic black	Plastic	C - A - C	C = 45°	45-2819.1C60.003	1	0.022 kg

45 Raised design

Lever	Front ring	Housing material	Switching action	Switching angle	Part No.	Wiring diagram	Weight
	Selector switch actuator 3 positions, short lever, Front dimension Ø 29.45 mm						
Plastic white	Plastic black	Plastic	C - A - C	C = 45°	45-2819.1C90.003	1	0.022 kg
	Selector switch actuator 3 positions, short lever, Front dimension Ø 29.45 mm						
Plastic red	Plastic black	Plastic	B - A - B	B = 45°	45-280S.1C20.003	2	0.022 kg
	Selector switch actuator 3 positions, short lever, Front dimension Ø 29.45 mm						
Plastic yellow	Plastic black	Plastic	B - A - B	B = 45°	45-280S.1C40.003	2	0.022 kg
	Selector switch actuator 3 positions, short lever, Front dimension Ø 29.45 mm						
Plastic green	Plastic black	Plastic	B - A - B	B = 45°	45-280S.1C50.003	2	0.022 kg
	Selector switch actuator 3 positions, short lever, Front dimension Ø 29.45 mm						
Plastic blue	Plastic black	Plastic	B - A - B	B = 45°	45-280S.1C60.003	2	0.022 kg
	Selector switch actuator 3 positions, short lever, Front dimension Ø 29.45 mm						
Plastic white	Plastic black	Plastic	B - A - B	B = 45°	45-280S.1C90.003	2	0.022 kg
	Selector switch actuator 3 positions, short lever, Front dimension Ø 29.45 mm						
Plastic red	Plastic black	Plastic	C - A - B	C = 45°, B = 45°	45-2816.1C20.003	3	0.022 kg
	Selector switch actuator 3 positions, short lever, Front dimension Ø 29.45 mm						
Plastic yellow	Plastic black	Plastic	C - A - B	C = 45°, B = 45°	45-2816.1C40.003	3	0.022 kg
	Selector switch actuator 3 positions, short lever, Front dimension Ø 29.45 mm						
Plastic green	Plastic black	Plastic	C - A - B	C = 45°, B = 45°	45-2816.1C50.003	3	0.022 kg
	Selector switch actuator 3 positions, short lever, Front dimension Ø 29.45 mm						
Plastic blue	Plastic black	Plastic	C - A - B	C = 45°, B = 45°	45-2816.1C60.003	3	0.022 kg

Lever	Front ring	Housing material	Switching action	Switching angle	Part No.	Wiring diagram	Weight
	Selector switch actuator 3 positions, short lever, Front dimension Ø 29.45 mm						
Plastic white	Plastic black	Plastic	C - A - B	C = 45°, B = 45°	45-2816.1C90.003	3	0.022 kg
	Selector switch actuator 3 positions, short lever, Front dimension Ø 29.45 mm						
Plastic red	Plastic black	Plastic	B - A - C	B = 45°, C = 45°	45-280X.1C20.003	4	0.022 kg
	Selector switch actuator 3 positions, short lever, Front dimension Ø 29.45 mm						
Plastic yellow	Plastic black	Plastic	B - A - C	B = 45°, C = 45°	45-280X.1C40.003	4	0.022 kg
	Selector switch actuator 3 positions, short lever, Front dimension Ø 29.45 mm						
Plastic green	Plastic black	Plastic	B - A - C	B = 45°, C = 45°	45-280X.1C50.003	4	0.022 kg
	Selector switch actuator 3 positions, short lever, Front dimension Ø 29.45 mm						
Plastic blue	Plastic black	Plastic	B - A - C	B = 45°, C = 45°	45-280X.1C60.003	4	0.022 kg
	Selector switch actuator 3 positions, short lever, Front dimension Ø 29.45 mm						
Plastic white	Plastic black	Plastic	B - A - C	B = 45°, C = 45°	45-280X.1C90.003	4	0.022 kg
	Selector switch actuator 3 positions, short lever, Front dimension Ø 29.45 mm						
Plastic red	Metal sandgrey	Plastic	C - A - C	C = 45°	45-2819.3C20.003	1	0.022 kg
	Selector switch actuator 3 positions, short lever, Front dimension Ø 29.45 mm						
Plastic yellow	Metal sandgrey	Plastic	C - A - C	C = 45°	45-2819.3C40.003	1	0.022 kg
	Selector switch actuator 3 positions, short lever, Front dimension Ø 29.45 mm						
Plastic green	Metal sandgrey	Plastic	C - A - C	C = 45°	45-2819.3C50.003	1	0.022 kg
	Selector switch actuator 3 positions, short lever, Front dimension Ø 29.45 mm						
Plastic blue	Metal sandgrey	Plastic	C - A - C	C = 45°	45-2819.3C60.003	1	0.022 kg

45 Raised design

Lever	Front ring	Housing material	Switching action	Switching angle	Part No.	Wiring diagram	Weight
	Selector switch actuator 3 positions, short lever, Front dimension Ø 29.45 mm						
Plastic white	Metal sandgrey	Plastic	C - A - C	C = 45°	45-2819.3C90.003	1	0.022 kg
	Selector switch actuator 3 positions, short lever, Front dimension Ø 29.45 mm						
Plastic red	Metal sandgrey	Plastic	B - A - B	B = 45°	45-280S.3C20.003	2	0.022 kg
	Selector switch actuator 3 positions, short lever, Front dimension Ø 29.45 mm						
Plastic yellow	Metal sandgrey	Plastic	B - A - B	B = 45°	45-280S.3C40.003	2	0.022 kg
	Selector switch actuator 3 positions, short lever, Front dimension Ø 29.45 mm						
Plastic green	Metal sandgrey	Plastic	B - A - B	B = 45°	45-280S.3C50.003	2	0.022 kg
	Selector switch actuator 3 positions, short lever, Front dimension Ø 29.45 mm						
Plastic blue	Metal sandgrey	Plastic	B - A - B	B = 45°	45-280S.3C60.003	2	0.022 kg
	Selector switch actuator 3 positions, short lever, Front dimension Ø 29.45 mm						
Plastic white	Metal sandgrey	Plastic	B - A - B	B = 45°	45-280S.3C90.003	2	0.022 kg
	Selector switch actuator 3 positions, short lever, Front dimension Ø 29.45 mm						
Plastic red	Metal sandgrey	Plastic	C - A - B	C = 45°, B = 45°	45-2816.3C20.003	3	0.022 kg
	Selector switch actuator 3 positions, short lever, Front dimension Ø 29.45 mm						
Plastic yellow	Metal sandgrey	Plastic	C - A - B	C = 45°, B = 45°	45-2816.3C40.003	3	0.022 kg
	Selector switch actuator 3 positions, short lever, Front dimension Ø 29.45 mm						
Plastic green	Metal sandgrey	Plastic	C - A - B	C = 45°, B = 45°	45-2816.3C50.003	3	0.022 kg
	Selector switch actuator 3 positions, short lever, Front dimension Ø 29.45 mm						
Plastic blue	Metal sandgrey	Plastic	C - A - B	C = 45°, B = 45°	45-2816.3C60.003	3	0.022 kg

Lever	Front ring	Housing material	Switching action	Switching angle	Part No.	Wiring diagram	Weight
	Selector switch actuator 3 positions, short lever, Front dimension Ø 29.45 mm						
Plastic white	Metal sandgrey	Plastic	C - A - B	C = 45°, B = 45°	45-2816.3C90.003	3	0.022 kg
	Selector switch actuator 3 positions, short lever, Front dimension Ø 29.45 mm						
Plastic red	Metal sandgrey	Plastic	B - A - C	B = 45°, C = 45°	45-280X.3C20.003	4	0.022 kg
	Selector switch actuator 3 positions, short lever, Front dimension Ø 29.45 mm						
Plastic yellow	Metal sandgrey	Plastic	B - A - C	B = 45°, C = 45°	45-280X.3C40.003	4	0.022 kg
	Selector switch actuator 3 positions, short lever, Front dimension Ø 29.45 mm						
Plastic green	Metal sandgrey	Plastic	B - A - C	B = 45°, C = 45°	45-280X.3C50.003	4	0.022 kg
	Selector switch actuator 3 positions, short lever, Front dimension Ø 29.45 mm						
Plastic blue	Metal sandgrey	Plastic	B - A - C	B = 45°, C = 45°	45-280X.3C60.003	4	0.022 kg
	Selector switch actuator 3 positions, short lever, Front dimension Ø 29.45 mm						
Plastic white	Metal sandgrey	Plastic	B - A - C	B = 45°, C = 45°	45-280X.3C90.003	4	0.022 kg
	Selector switch actuator 3 positions, short lever, Front dimension Ø 29.45 mm						
Plastic red	Metal silver	Metal	C - A - C	C = 45°	45-2819.2C20.003	1	0.022 kg
	Selector switch actuator 3 positions, short lever, Front dimension Ø 29.45 mm						
Plastic yellow	Metal silver	Metal	C - A - C	C = 45°	45-2819.2C40.003	1	0.022 kg
	Selector switch actuator 3 positions, short lever, Front dimension Ø 29.45 mm						
Plastic green	Metal silver	Metal	C - A - C	C = 45°	45-2819.2C50.003	1	0.022 kg
	Selector switch actuator 3 positions, short lever, Front dimension Ø 29.45 mm						
Plastic white	Metal silver	Metal	C - A - C	C = 45°	45-2819.2C90.003	1	0.022 kg

45 Raised design

Lever	Front ring	Housing material	Switching action	Switching angle	Part No.	Wiring diagram	Weight
	Selector switch actuator 3 positions, short lever, Front dimension Ø 29.45 mm						
Plastic red	Metal silver	Metal	B - A - B	B = 45°	45-280S.2C20.003	2	0.022 kg
	Selector switch actuator 3 positions, short lever, Front dimension Ø 29.45 mm						
Plastic ambergris	Metal silver	Metal	B - A - B	B = 45°	45-280S.2C30.003	2	0.022 kg
	Selector switch actuator 3 positions, short lever, Front dimension Ø 29.45 mm						
Plastic yellow	Metal silver	Metal	B - A - B	B = 45°	45-280S.2C40.003	2	0.022 kg
	Selector switch actuator 3 positions, short lever, Front dimension Ø 29.45 mm						
Plastic green	Metal silver	Metal	B - A - B	B = 45°	45-280S.2C50.003	2	0.022 kg
	Selector switch actuator 3 positions, short lever, Front dimension Ø 29.45 mm						
Plastic blue	Metal silver	Metal	B - A - B	B = 45°	45-280S.2C60.003	2	0.022 kg
	Selector switch actuator 3 positions, short lever, Front dimension Ø 29.45 mm						
Plastic white	Metal silver	Metal	B - A - B	B = 45°	45-280S.2C90.003	2	0.022 kg
	Selector switch actuator 3 positions, short lever, Front dimension Ø 29.45 mm						
Plastic red	Metal silver	Metal	C - A - B	C = 45°, B = 45°	45-2816.2C20.003	3	0.022 kg
	Selector switch actuator 3 positions, short lever, Front dimension Ø 29.45 mm						
Plastic green	Metal silver	Metal	C - A - B	C = 45°, B = 45°	45-2816.2C50.003	3	0.022 kg
	Selector switch actuator 3 positions, short lever, Front dimension Ø 29.45 mm						
Plastic white	Metal silver	Metal	C - A - B	C = 45°, B = 45°	45-2816.2C90.003	3	0.022 kg
			B - A - C	B = 45°, C = 45°	45-280X.2C90.003		

Switching action: A = Rest, B = Momentary, C = Maintain

			
Wiring diagram 1	Wiring diagram 2	Wiring diagram 3	Wiring diagram 4

45 Raised design

Selector switch 3 positions long lever, IP66, IP67, IP69K



Product can differ from the current configuration.



Dimensions [mm]

Additional Information

- Mounting depth incl. front plate, see chapter «drawings»
- External diameter of the long lever 44.8 mm



Mounting cut-outs [mm]

Equipment consisting of (schematic overview)



Each Part Number listed below includes all the black components shown in the 3D-drawing.

To obtain a complete unit, please select the red components from the pages shown.



Switching positions (A = Rest, B = Momentary, C = Maintained)

Lever	Front ring	Housing material	Switching action	Switching angle	Part No.	Wiring diagram	Weight
	Selector switch actuator 3 positions, long lever, Front dimension Ø 29.45 mm						
Plastic red	Metal silver	Metal	C - A - C	C = 45°	45-2819.2D20.003	1	0.022 kg
	Selector switch actuator 3 positions, long lever, Front dimension Ø 29.45 mm						
Plastic green	Metal silver	Metal	C - A - C	C = 45°	45-2819.2D50.003	1	0.022 kg
	Selector switch actuator 3 positions, long lever, Front dimension Ø 29.45 mm						
Plastic white	Metal silver	Metal	C - A - C	C = 45°	45-2819.2D90.003	1	0.022 kg
	Selector switch actuator 3 positions, long lever, Front dimension Ø 29.45 mm						
Plastic red	Metal silver	Metal	B - A - B	B = 45°	45-280S.2D20.003	2	0.022 kg

Lever	Front ring	Housing material	Switching action	Switching angle	Part No.	Wiring diagram	Weight
 <p>Selector switch actuator 3 positions, long lever, Front dimension Ø 29.45 mm</p>							
Plastic green	Metal silver	Metal	B - A - B	B = 45°	45-280S.2D50.003	2	0.022 kg
 <p>Selector switch actuator 3 positions, long lever, Front dimension Ø 29.45 mm</p>							
Plastic white	Metal silver	Metal	B - A - B	B = 45°	45-280S.2D90.003	2	0.022 kg
 <p>Selector switch actuator 3 positions, long lever, Front dimension Ø 29.45 mm</p>							
Plastic red	Metal silver	Metal	C - A - B	C = 45°, B = 45°	45-2816.2D20.003	3	0.022 kg
 <p>Selector switch actuator 3 positions, long lever, Front dimension Ø 29.45 mm</p>							
Plastic white	Metal silver	Metal	C - A - B	C = 45°, B = 45°	45-2816.2D90.003	3	0.022 kg
 <p>Selector switch actuator 3 positions, long lever, Front dimension Ø 29.45 mm</p>							
Plastic red	Metal silver	Metal	B - A - C	B = 45°, C = 45°	45-280X.2D20.003	4	0.022 kg
 <p>Selector switch actuator 3 positions, long lever, Front dimension Ø 29.45 mm</p>							
Plastic white	Metal silver	Metal	B - A - C	B = 45°, C = 45°	45-280X.2D90.003	4	0.022 kg

Switching action: A = Rest, B = Momentary, C = Maintain

			
Wiring diagram 1	Wiring diagram 2	Wiring diagram 3	Wiring diagram 4

45 Raised design

Selector switch actuator 4 positions round lever, IP66, IP67, IP69K



Product can differ from the current configuration.



Dimensions [mm]

Additional Information

- Use only with holder for 4 elements
- Mounting depth incl. front plate, see chapter «drawings»



Mounting cut-outs [mm]

Equipment consisting of (schematic overview)



Each Part Number listed below includes all the black components shown in the 3D-drawing.

To obtain a complete unit, please select the red components from the pages shown.

Lever	Front ring	Housing material	Switching action	Switching angle	Part No.	Wiring diagram	Weight
	Selector switch actuator 4 positions, round lever, Front dimension Ø 29.45 mm						
Plastic white	Plastic black	Plastic	C	C = 90°	45-2845.1E90.002	1	0.023 kg
	Selector switch actuator 4 positions, round lever, Front dimension Ø 29.45 mm						
Plastic white	Metal sandgrey	Plastic	C	C = 90°	45-2845.3E90.002	1	0.023 kg
	Selector switch actuator 4 positions, round lever, Front dimension Ø 29.45 mm						
Plastic white	Metal silver	Metal	C	C = 90°	45-2845.2E90.002	1	0.023 kg

Switching action: C = Maintain



Potentiometer, IP66, IP67, IP69K

Equipment consisting of (schematic overview)



Dimensions [mm]



Product can differ from the current configuration.

Each Part Number listed below includes all the black components shown in the 3D-drawing.

To obtain a complete unit, please select the red components from the pages shown.



Mounting cut-outs [mm]

Additional Information

- Power 0.5 W
- Slewing range 275° ±2°
- Mounting depth incl. front plate, see chapter «drawings»

Product attribute	Front ring	Housing material	Part No.	Component layout	Wiring diagram	Weight
 <p>Potentiometer, Front dimension Ø 29.45 mm</p>						
Resistor 1 kOhm / linear, series E3	Plastic black	Plastic	45-2P03.1E10.000	1	1	0.03 kg
Resistor 4.7 kOhm / linear, series E3	Plastic black	Plastic	45-2P04.1E10.000	1	1	0.03 kg
Resistor 10 kOhm / linear, series E3	Plastic black	Plastic	45-2P02.1E10.000	1	1	0.03 kg
Resistor 47 kOhm / linear, series E3	Plastic black	Plastic	45-2P06.1E10.000	1	1	0.03 kg
Resistor 100 kOhm / linear, series E3	Plastic black	Plastic	45-2P01.1E10.000	1	1	0.03 kg
Resistor 470 kOhm / linear, series E3	Plastic black	Plastic	45-2P05.1E10.000	1	1	0.03 kg
 <p>Potentiometer, Front dimension Ø 29.45 mm</p>						
Resistor 1 kOhm / linear, series E3	Metal silver	Metal	45-2P03.2E10.000	1	1	0.03 kg
Resistor 4.7 kOhm / linear, series E3	Metal silver	Metal	45-2P04.2E10.000	1	1	0.03 kg
Resistor 10 kOhm / linear, series E3	Metal silver	Metal	45-2P02.2E10.000	1	1	0.03 kg
Resistor 47 kOhm / linear, series E3	Metal silver	Metal	45-2P06.2E10.000	1	1	0.03 kg
Resistor 100 kOhm / linear, series E3	Metal silver	Metal	45-2P01.2E10.000	1	1	0.03 kg
Resistor 470 kOhm / linear, series E3	Metal silver	Metal	45-2P05.2E10.000	1	1	0.03 kg

The component layouts you will find from Page 144

45 Raised design



Toggle stick, IP 65, IP 67

Equipment consisting of (schematic overview)



Each Part Number listed below includes all the black components shown in the 3D-drawing.

To obtain a complete unit, please select the red components from the pages shown.



Dimensions [mm]



Mounting cut-outs [mm]



Product can differ from the current configuration.

Additional Information

- Use only with holder for 4 elements
- Mounting depth incl. front plate, see chapter «drawings»

Product attribute	Front ring	Housing material	Switching action	Part No.	Wiring diagram	Weight
 <p>Toggle stick, Front dimension Ø 29.45 mm</p>						
2 positions (L-R), lockable	Plastic black	Plastic	B	45-2F13.1010.000	1	0.035 kg
2 positions (U-D), lockable	Plastic black	Plastic	B	45-2F40.1010.000	3	0.035 kg
4-positions, lockable	Plastic black	Plastic	B	45-2F14.1010.000	5	0.035 kg
 <p>Toggle stick, Front dimension Ø 29.45 mm</p>						
2 positions (L-R), lockable	Metal sandgrey	Plastic	B	45-2F13.3010.000	1	0.042 kg
2 positions (U-D), lockable	Metal sandgrey	Plastic	B	45-2F40.3010.000	3	0.042 kg
4-positions, lockable	Metal sandgrey	Plastic	B	45-2F14.3010.000	5	0.042 kg
 <p>Toggle stick, Front dimension Ø 29.45 mm</p>						
2 positions (L-R), lockable	Metal silver	Metal	B	45-2F13.2010.000	1	0.081 kg
2 positions (U-D), lockable	Metal silver	Metal	B	45-2F40.2010.000	3	0.081 kg
4-positions, lockable	Metal silver	Metal	B	45-2F14.2010.000	5	0.081 kg

45 Raised design

Product attribute	Front ring	Housing material	Switching action	Part No.	Wiring diagram	Weight
 <p>Toggle stick, Front dimension Ø 29.45 mm</p>						
2 positions (L-R)	Plastic black	Plastic	B	45-2F0T.1010.000	1	0.035 kg
2 positions (U-D)	Plastic black	Plastic	B	45-2F38.1010.000	3	0.035 kg
4 positions	Plastic black	Plastic	B	45-2F0V.1010.000	5	0.035 kg
 <p>Toggle stick, Front dimension Ø 29.45 mm</p>						
2 positions (L-R)	Metal sandgrey	Plastic	B	45-2F0T.3010.000	1	0.042 kg
2 positions (U-D)	Metal sandgrey	Plastic	B	45-2F38.3010.000	3	0.042 kg
4 positions	Metal sandgrey	Plastic	B	45-2F0V.3010.000	5	0.042 kg
 <p>Toggle stick, Front dimension Ø 29.45 mm</p>						
2 positions (L-R)	Metal silver	Metal	B	45-2F0T.2010.000	1	0.081 kg
2 positions (U-D)	Metal silver	Metal	B	45-2F38.2010.000	3	0.081 kg
4 positions	Metal silver	Metal	B	45-2F0V.2010.000	5	0.081 kg

Switching action: B = Momentary



Toggle switches, IP66, IP67, IP69K

Equipment consisting of (schematic overview)



Each Part Number listed below includes all the black components shown in the 3D-drawing.

To obtain a complete unit, please select the red components from the pages shown.



Dimensions [mm]



Product can differ from the current configuration.



Mounting cut-outs [mm]

Additional Information

- Mounting depth incl. front plate, see chapter «drawings»

Product attribute	Lever	Front ring	Switching action	Part No.	Wiring diagram	Weight
 <p>Toggle switch actuator, Front dimension Ø 29.45 mm</p>						
reset from above	Plastic black	Plastic black	C	45-2N42.1010.000	1	0.015 kg
–	Plastic black	Plastic black	B	45-2N39.1010.000	2	0.015 kg
 <p>Toggle switch actuator, Front dimension Ø 29.45 mm</p>						
reset from above	Plastic black	Metal sandgrey	C	45-2N42.3010.000	1	0.020 kg
–	Plastic black	Metal sandgrey	B	45-2N39.3010.000	2	0.020 kg
 <p>Toggle switch actuator, Front dimension Ø 29.45 mm</p>						
reset from above	Plastic black	Metal silver	C	45-2N42.2010.000	1	0.038 kg
–	Plastic black	Metal silver	B	45-2N39.2010.000	2	0.038 kg

Switching action: B = Momentary, C = Maintain

Wiring diagram 1	Wiring diagram 2

Lens plastic round flat



Dimensions [mm]

Dimension	Lens	Part No.	Weight
	Lens		
Ø 23.7 mm	Plastic black	45-553.0100	0.001 kg
	Lens		
Ø 23.7 mm	Plastic red	45-553.0200	0.001 kg
	Lens		
Ø 23.7 mm	Plastic yellow	45-553.0400	0.001 kg
	Lens		
Ø 23.7 mm	Plastic green	45-553.0500	0.001 kg
	Lens		
Ø 23.7 mm	Plastic blue	45-553.0600	0.001 kg
	Lens		
Ø 23.7 mm	Plastic white	45-553.0900	0.001 kg
	Lens		
Ø 23.7 mm	Plastic red transparent	45-553.0E00	0.001 kg

Dimension	Lens	Part No.	Weight
	Lens		
Ø 23.7 mm	Plastic amber transparent	45-553.0F00	0.001 kg
	Lens		
Ø 23.7 mm	Plastic yellow transparent	45-553.0G00	0.001 kg
	Lens		
Ø 23.7 mm	Plastic green transparent	45-553.0H00	0.001 kg
	Lens		
Ø 23.7 mm	Plastic blue transparent	45-553.0J00	0.001 kg
	Lens		
Ø 23.7 mm	Plastic white transparent	45-553.0K00	0.001 kg
	Lens		
Ø 23.7 mm	Plastic colourless transparent	45-553.0N00	0.001 kg

Lens plastic round increased



Dimensions [mm]

Dimension	Lens	Part No.	Weight
	Lens		
Ø 23.7 mm	Plastic black	45-552.0100	0.002 kg

Dimension	Lens	Part No.	Weight
	Lens		
Ø 23.7 mm	Plastic red	45-552.0200	0.002 kg
	Lens		
Ø 23.7 mm	Plastic yellow	45-552.0400	0.002 kg
	Lens		
Ø 23.7 mm	Plastic green	45-552.0500	0.002 kg
	Lens		
Ø 23.7 mm	Plastic red transparent	45-552.0E00	0.002 kg
	Lens		
Ø 23.7 mm	Plastic yellow transparent	45-552.0G00	0.002 kg
	Lens		
Ø 23.7 mm	Plastic green transparent	45-552.0H00	0.002 kg
	Lens		
Ø 23.7 mm	Plastic blue transparent	45-552.0J00	0.002 kg
	Lens		
Ø 23.7 mm	Plastic colourless transparent	45-552.0K00	0.002 kg

Marking plate

Additional Information

- For pushbutton illuminated
- Markable, see «Marking»
- To change the text plate, the push cap is removed with a screwdriver and then snapped back



Dimensions [mm]

Marking plate illumination	Marking plate	Part No.	Weight
	Marking plate		
illuminative	white translucent	45-563.0K00	0.001 kg

Legend plate

Additional Information

- Markable, see «Marking»



Dimensions [mm]

Product attribute	Dimension	Material	Colour	Part No.	Weight
 <p>Legend plate</p>					
For sticking or snapping in place	27 x 12.5 mm	Plastic	black	45-573.1102	0.001 kg
For sticking or snapping in place	27 x 12.5 mm	Plastic	red	45-573.1202	0.001 kg
For sticking or snapping in place	27 x 12.5 mm	Plastic	silver	45-573.1A02	0.001 kg
 <p>Legend plate</p>					
For sticking or snapping in place	27 x 17.5 mm	Plastic	black	45-573.1103	0.001 kg
For sticking or snapping in place	27 x 17.5 mm	Plastic	silver	45-573.1A03	0.001 kg
 <p>Legend plate</p>					
For sticking or snapping in place	27 x 27 mm	Plastic	black	45-573.1105	0.001 kg
For sticking or snapping in place	27 x 27 mm	Plastic	silver	45-573.1A05	0.001 kg
 <p>Legend plate</p>					
For sticking or snapping in place	22 x 22 mm	Plastic	silver	45-573.1A04	0.001 kg
For sticking	22 x 22 mm	Plastic	black	45-573.1104	0.001 kg

Emergency-stop legend

Additional Information

- Front panel thickness 3 mm max.

Product attribute	Dimension	Mounting cut-out	Marking	Colour	Part No.	Weight
	Emergency-stop legend					
-	Ø 45 x 1 mm	Ø 22.5 mm	without marking	yellow	45-50K.1407	0.005 kg
	Emergency-stop legend					
-	Ø 75 x 1 mm	Ø 22.5 mm	without marking	yellow	45-50K.1408	0.010 kg
	Emergency-stop legend					
self-adhesive	Ø 75 x 1 mm	Ø 23 mm	without marking	yellow	45-50J.1400	0.004 kg
	Emergency-stop legend					
self-adhesive	Ø 75 x 1 mm	Ø 23 mm	NOT - HALT	yellow	45-50J.140Q	0.004 kg
	Emergency-stop legend					
self-adhesive	Ø 75 x 1 mm	Ø 23 mm	EMERGENCY STOP	yellow	45-50J.140S	0.004 kg
	Emergency-stop legend					
self-adhesive	Ø 75 x 1 mm	Ø 23 mm	NOT - AUS	yellow	45-50J.140P	0.004 kg
	Emergency-stop legend					
self-adhesive	Ø 75 x 1 mm	Ø 23 mm	ARRET D'URGENCE	yellow	45-50J.140T	0.004 kg
	Emergency-stop legend					
self-adhesive	Ø 75 x 1 mm	Ø 23 mm	EMERGENZA	yellow	45-50J.140V	0.004 kg
	Emergency-stop legend					
self-adhesive	Ø 75 x 1 mm	Ø 23 mm	NODSTOP	yellow	45-50J.140W	0.004 kg

Product attribute	Dimension	Mounting cut-out	Marking	Colour	Part No.	Weight
 <p>Emergency-stop legend</p>						
self-adhesive	Ø 75 x 1 mm	Ø 23 mm	紧急停止	yellow	45-50J.140X	0.004 kg
 <p>Emergency-stop legend</p>						
self-adhesive	Ø 75 x 1 mm	Ø 23 mm	NOT-HALT EMERGENCY STOP EMERGENZA EMERGENCIA	yellow	45-50J.140Z	0.004 kg
 <p>Emergency-stop legend</p>						
self-adhesive	150 x 38 mm	Ø 23 mm	without marking	yellow	45-561.1400	0.004 kg
 <p>Emergency-stop legend</p>						
self-adhesive	150 x 38 mm	Ø 23 mm	NOT - AUS	yellow	45-561.140P	0.004 kg
 <p>Emergency-stop legend</p>						
self-adhesive	150 x 38 mm	Ø 23 mm	without marking	yellow	45-562.1400	0.004 kg

Legend plate for potentiometer

Dimension	Material	Colour	Part No.	Weight
 <p>Legend plate for potentiometer</p>				
Ø 40 mm	Plastic	black	45-538.1100	0.001 kg

Legend support without legend

Additional Information

- For sticking or snapping in place



Product attribute	Material	Colour	Part No.	Weight
 <p>Legend support without legend</p>				
for legend plate 27 x 12.5 mm	Plastic	black	45-564.1102	0.002 kg
 <p>Legend support without legend</p>				
for legend plate 27 x 17.5 mm	Plastic	black	45-567.1103	0.002 kg
 <p>Legend support without legend</p>				
for legend plate 27 x 27 mm	Plastic	black	45-569.1105	0.002 kg

Product attribute	Material	Colour	Part No.	Weight
 <p>Legend support without legend</p>				
for legend plate 27 x 27 mm	Plastic	black	45-570.1105	0.002 kg
 <p>Legend support without legend</p>				
for legend plate 27 x 12.5 mm	Plastic	black	45-564.1110	0.002 kg
 <p>Legend support without legend</p>				
for legend plate 27 x 17.5 mm	Plastic	black	45-567.1111	0.002 kg
 <p>Legend support without legend</p>				
for legend plate 27 x 27 mm	Plastic	black	45-569.1112	0.002 kg

Legend support without legend for toggle stick

Additional Information

- For sticking or snapping in place



Dimensions [mm]

Product attribute	Material	Colour	Part No.	Weight
 <p>Legend support without legend for toggle stick</p>				
for legend plate 27 x 27 mm	Plastic	black	45-571.1105	0.002 kg
 <p>Legend support without legend for toggle stick</p>				
for legend plate 27 x 27 mm	Plastic	black	45-572.1105	0.002 kg

Single frame, IP66, IP67, IP69K

Additional Information

- For design square



Dimensions [mm]

Dimension	Material	Colour	Part No.	Weight
	Single frame for design square			
29.8 x 29.8 mm	Plastic	black	45-558.0000	0.001 kg

Protective cover, IP66, IP67

Additional Information

- Hinged, with means for sealing
- Please note that bigger minimum distances are necessary



Dimensions [mm]

Material	Colour	Optics	Part No.	Weight
	Protective cover			
Plastic	black	opaque	45-555.1100	0.012 kg
	Protective cover			
Plastic	colourless	transparent	45-555.1K00	0.012 kg

Protective cap

Product attribute	Front protection	Material	Colour	Optics	Part No.	Weight
 <p>Protective cap for pushbutton</p>						
for lens raised above bezel	IP66, IP67	Silicone	colourless	transparent	45-544.1K00	0.008 kg
for lens flush	IP66, IP67	Silicone	colourless	transparent	45-545.1K00	0.008 kg
 <p>Protective cap for twin pushbutton</p>						
for lens raised above bezel	IP66, IP67	Silicone	colourless	transparent	45-547.1K00	0.011 kg
for lens flush	IP66, IP67	Silicone	colourless	transparent	45-548.1K00	0.011 kg
 <p>Protective cap for Emergency stop switch</p>						
for lens raised above bezel	IP66, IP67	Silicone	colourless	transparent	45-542.1K00	0.015 kg
 <p>Protective cap for Mushroom-head pushbutton</p>						
for Mushroom-head pushbutton Ø 40	IP66, IP67	Silicone	colourless	transparent	45-543.1K00	0.006 kg
 <p>Protective cap for selector switch</p>						
for lever switch, short lever	IP66, IP67	Silicone	colourless	transparent	45-546.1K00	0.006 kg
 <p>Protective cap for keylock switch</p>						
for keylock switch	IP66, IP67	Silicone	colourless	transparent	45-50F.1100	0.006 kg

Cover, IP66, IP67, IP69K



Dimensions [mm]

Product attribute	Material	Colour	Optics	Part No.	Weight
 <p>Cover for locking device</p>					
For pushbuttons, selector switches with round or short lever	Metall/Kunststoff	silver/colourless	transparent	45-529.2100	0.043 kg

E-stop protective shroud

Additional Information

- The protection shroud is not suitable for a proper use of emergency-stop. It can obstruct a spontaneous operation of the emergency-stop



Dimensions [mm]

Product attribute	Material	Colour	Part No.	Weight
 E-stop protective shroud				
non-illuminative	Plastic	yellow	45-549.1400	0.052 kg
 E-stop protective shroud				
non-illuminative	Plastic	grey	45-549.1800	0.052 kg
 E-stop protective shroud				
non-illuminative	Plastic	yellow	45-550.1400	0.044 kg
 E-stop protective shroud				
for Emergency stop switch Ø 40 mm, for 5 padlocks	Metal	yellow	45-539.2400	0.162 kg
 E-stop protective shroud				
for Emergency stop switch Ø 40 mm, for 5 padlocks	Metal	grey	45-539.2800	0.153 kg



Dimensions [mm]

Product attribute	Material	Colour	Part No.	Weight
 <p>Protective shroud</p>				
for pushbutton, selector switch	Plastic	black	45-50N.1100	0.010 kg
 <p>Protective shroud</p>				
for pushbuttons	Metal	silver	45-50Q.2100	0.020 kg
 <p>Protective shroud</p>				
for mushroom-head pushbutton Ø 40 mm	Metal	silver	45-50P.0100	0.020 kg

Sun collar

Product attribute	Material	Colour	Part No.	Weight
 <p>Sun collar</p>				
for pushbutton illuminated	Plastic	black	45-560.1100	0.010 kg

Blind plug, IP66, IP67, IP69K

Additional Information

- Use with plastic or metal holder



Dimensions [mm]

Mounting cut-out	Material	Colour	Part No.	Weight
 <p>Blind plug</p>				
Ø 22.5 mm	Plastic	black	45-506.1100	0.010 kg
 <p>Blind plug</p>				
Ø 22.5 mm	Metal sandgrey	silver	45-506.3A00	0.008 kg
 <p>Blind plug</p>				
Ø 22.5 mm	Metal shiny	silver	45-506.2A00	0.038 kg

Locking device, IP66, IP67, IP69K

Product attribute	Dimension	Material	Colour	Part No.	Weight
 <p>Locking device</p>					
for pushbutton with lens raised	47 x 43.1 x 25.1 mm	Metal	silver	45-531.2100	0.047 kg
 <p>Locking device</p>					
for pushbutton with lens flat	47 x 43.1 x 25.1 mm	Metal	silver	45-532.2100	0.047 kg
for mushroom-head pushbutton Ø 30 mm or Ø 40 mm	47 x 43.1 x 25.1 mm	Metal	silver	45-530.2100	0.047 kg
 <p>Locking device</p>					
for selector switch in position left	47 x 47.1 x 21.1 mm	Metal	silver	45-534.2100	0.047 kg
 <p>Locking device</p>					
for selector switch in position center	47 x 47.1 x 21.1 mm	Metal	silver	45-533.2100	0.047 kg
 <p>Locking device</p>					
for selector switch in position right	47 x 47.1 x 21.1 mm	Metal	silver	45-536.2100	0.047 kg
 <p>Locking device</p>					
for selector switch in position center and right	47 x 47.1 x 21.1 mm	Metal	silver	45-535.2100	0.047 kg
 <p>Locking device</p>					
for selector switch in position center and left	47 x 47.1 x 21.1 mm	Metal	silver	45-537.2100	0.047 kg

Spare key

Additional Information

- For standard lock RONIS T254

Product attribute	Part No.	Weight
 <p>Spare key</p>	45-522.0900	0.007 kg
2 spare keys		

Holder for 3 elements



Dimensions [mm]

Product attribute	Material	Part No.	Component layout	Weight
 <p>Holder for 3 elements</p>				
for all buttons except selector switch 4 positions and toggle stick	Plastic	45-2300.1000.000	2	0.028 kg
 <p>Holder for 3 elements</p>				
for all buttons except selector switch 4 positions and toggle stick	Metal	45-2300.2000.000	2	0.046 kg

The component layouts you will find from Page 145

Holder for 4 elements



Dimensions [mm]

Product attribute	Material	Part No.	Component layout	Weight
 <p>Holder for 4 elements</p>				
for selector switch 4 positions and toggle stick	Plastic	45-2400.1000.000	3	0.028 kg
 <p>Holder for 4 elements</p>				
for selector switch 4 positions and toggle stick	Metal	45-2400.2000.000	3	0.046 kg

The component layouts you will find from Page 145

Switching element front mounting



Dimensions [mm]
 X = Screw terminal,
 SP = Spring-type terminal

Switching current	Contacts	Contact material	Terminal	Part No.	Wiring diagram	Weight
 <p>Switching element</p>						
10 A	1 NO	Silver	Screw	45-311.1Z10	1	0.010 kg
10 A	1 NC	Silver	Screw	45-312.1Z10	2	0.010 kg
 <p>Switching element</p>						
10 A	1 NO	Silver	Spring-type terminal	45-311.1Z40	1	0.010 kg
10 A	1 NC	Silver	Spring-type terminal	45-312.1Z40	2	0.010 kg



Switching element base mounting



Dimensions [mm]
 X = Screw terminal,
 SP = Spring-type terminal

Switching current	Contacts	Contact material	Terminal	Part No.	Wiring diagram	Weight
	Switching element					
10 A	1 NO	Silver	Screw	45-311.2Z10	1	0.010 kg
	Switching element					
10 A	1 NC	Silver	Screw	45-312.2Z10	2	0.010 kg
	Switching element					
10 A	1 NO	Silver	Spring-type terminal	45-311.2Z40	1	0.010 kg
	Switching element					
10 A	1 NC	Silver	Spring-type terminal	45-312.2Z40	2	0.010 kg





Dimensions [mm]
 X = Screw terminal,
 SP = Spring-type terminal

LED colour	Operating voltage	Lumi. intensity	Terminal	Part No.	Wiring dia-gram	Weight
 <p style="text-align: center;">Illumination element</p>						
red	6-24 VAC/DC	450...1120 mcd	Screw	45-320.1E11	1	0.009 kg
amber	6-24 VAC/DC	450...1120 mcd	Screw	45-320.1F11	1	0.009 kg
yellow	6-24 VAC/DC	900...1400 mcd	Screw	45-320.1G11	1	0.009 kg
green	6-24 VAC/DC	900...1400 mcd	Screw	45-320.1H11	1	0.009 kg
blue	6-24 VAC/DC	280...710 mcd	Screw	45-320.1J11	1	0.009 kg
white	6-24 VAC/DC	900...1400 mcd	Screw	45-320.1N11	1	0.009 kg
red	24-240 VAC/DC	450...1120 mcd	Screw	45-320.1E12	1	0.010 kg
amber	24-240 VAC/DC	450...1120 mcd	Screw	45-320.1F12	1	0.010 kg
yellow	24-240 VAC/DC	900...1400 mcd	Screw	45-320.1G12	1	0.010 kg
green	24-240 VAC/DC	900...1400 mcd	Screw	45-320.1H12	1	0.010 kg
blue	24-240 VAC/DC	280...710 mcd	Screw	45-320.1J12	1	0.010 kg
white	24-240 VAC/DC	900...1400 mcd	Screw	45-320.1N12	1	0.010 kg
red	24 VAC/DC	450...1120 mcd	Screw	45-320.1E16	1	0.009 kg
amber	24 VAC/DC	450...1120 mcd	Screw	45-320.1F16	1	0.009 kg
yellow	24 VAC/DC	900...1400 mcd	Screw	45-320.1G16	1	0.009 kg
green	24 VAC/DC	900...1400 mcd	Screw	45-320.1H16	1	0.009 kg
blue	24 VAC/DC	280...710 mcd	Screw	45-320.1J16	1	0.009 kg
white	24 VAC/DC	900...1400 mcd	Screw	45-320.1N16	1	0.009 kg
red	110 VAC	450...1120 mcd	Screw	45-320.1E17	1	0.010 kg
amber	110 VAC	450...1120 mcd	Screw	45-320.1F17	1	0.010 kg
yellow	110 VAC	900...1400 mcd	Screw	45-320.1G17	1	0.010 kg
green	110 VAC	900...1400 mcd	Screw	45-320.1H17	1	0.010 kg
blue	110 VAC	280...710 mcd	Screw	45-320.1J17	1	0.010 kg
white	110 VAC	900...1400 mcd	Screw	45-320.1N17	1	0.010 kg

LED colour	Operating voltage	Lumi. intensity	Terminal	Part No.	Wiring diagram	Weight
red	230 VAC	450...1120 mcd	Screw	45-320.1E18	1	0.010 kg
amber	230 VAC	450...1120 mcd	Screw	45-320.1F18	1	0.010 kg
yellow	230 VAC	900...1400 mcd	Screw	45-320.1G18	1	0.010 kg
green	230 VAC	900...1400 mcd	Screw	45-320.1H18	1	0.010 kg
blue	230 VAC	280...710 mcd	Screw	45-320.1J18	1	0.010 kg
white	230 VAC	900...1400 mcd	Screw	45-320.1N18	1	0.010 kg



Illumination element

red	6-24 VAC/DC	450...1120 mcd	Spring-type terminal	45-320.1E41	1	0.009 kg
amber	6-24 VAC/DC	450...1120 mcd	Spring-type terminal	45-320.1F41	1	0.009 kg
yellow	6-24 VAC/DC	900...1400 mcd	Spring-type terminal	45-320.1G41	1	0.009 kg
green	6-24 VAC/DC	900...1400 mcd	Spring-type terminal	45-320.1H41	1	0.009 kg
blue	6-24 VAC/DC	280...710 mcd	Spring-type terminal	45-320.1J41	1	0.009 kg
white	6-24 VAC/DC	900...1400 mcd	Spring-type terminal	45-320.1N41	1	0.009 kg
red	24-240 VAC/DC	450...1120 mcd	Spring-type terminal	45-320.1E42	1	0.010 kg
amber	24-240 VAC/DC	450...1120 mcd	Spring-type terminal	45-320.1F42	1	0.010 kg
yellow	24-240 VAC/DC	900...1400 mcd	Spring-type terminal	45-320.1G42	1	0.010 kg
green	24-240 VAC/DC	900...1400 mcd	Spring-type terminal	45-320.1H42	1	0.010 kg
blue	24-240 VAC/DC	280...710 mcd	Spring-type terminal	45-320.1J42	1	0.010 kg
white	24-240 VAC/DC	900...1400 mcd	Spring-type terminal	45-320.1N42	1	0.010 kg
red	24 VAC/DC	450...1120 mcd	Spring-type terminal	45-320.1E46	1	0.009 kg
amber	24 VAC/DC	450...1120 mcd	Spring-type terminal	45-320.1F46	1	0.009 kg
yellow	24 VAC/DC	900...1400 mcd	Spring-type terminal	45-320.1G46	1	0.009 kg
green	24 VAC/DC	900...1400 mcd	Spring-type terminal	45-320.1H46	1	0.009 kg
blue	24 VAC/DC	280...710 mcd	Spring-type terminal	45-320.1J46	1	0.009 kg
white	24 VAC/DC	900...1400 mcd	Spring-type terminal	45-320.1N46	1	0.009 kg
red	110 VAC	450...1120 mcd	Spring-type terminal	45-320.1E47	1	0.010 kg
amber	110 VAC	450...1120 mcd	Spring-type terminal	45-320.1F47	1	0.010 kg
yellow	110 VAC	900...1400 mcd	Spring-type terminal	45-320.1G47	1	0.010 kg
green	110 VAC	900...1400 mcd	Spring-type terminal	45-320.1H47	1	0.010 kg
blue	110 VAC	280...710 mcd	Spring-type terminal	45-320.1J47	1	0.010 kg
white	110 VAC	900...1400 mcd	Spring-type terminal	45-320.1N47	1	0.010 kg
red	230 VAC	450...1120 mcd	Spring-type terminal	45-320.1E48	1	0.010 kg
amber	230 VAC	450...1120 mcd	Spring-type terminal	45-320.1F48	1	0.010 kg
yellow	230 VAC	900...1400 mcd	Spring-type terminal	45-320.1G48	1	0.010 kg
green	230 VAC	900...1400 mcd	Spring-type terminal	45-320.1H48	1	0.010 kg
blue	230 VAC	280...710 mcd	Spring-type terminal	45-320.1J48	1	0.010 kg
white	230 VAC	900...1400 mcd	Spring-type terminal	45-320.1N48	1	0.010 kg



Wiring diagram 1

Illumination element base mounting



Dimensions [mm]
 X = Screw terminal,
 SP = Spring-type terminal

LED colour	Operating voltage	Lumi. intensity	Terminal	Part No.	Wiring dia-gram	Weight
	Illumination element					
red	6-24 VAC/DC	450...1120 mcd	Screw	45-320.2E11	1	0.009 kg
amber	6-24 VAC/DC	450...1120 mcd	Screw	45-320.2F11	1	0.009 kg
yellow	6-24 VAC/DC	900...1400 mcd	Screw	45-320.2G11	1	0.009 kg
green	6-24 VAC/DC	900...1400 mcd	Screw	45-320.2H11	1	0.009 kg
blue	6-24 VAC/DC	280...710 mcd	Screw	45-320.2J11	1	0.009 kg
white	6-24 VAC/DC	900...1400 mcd	Screw	45-320.2N11	1	0.009 kg
red	24-240 VAC/DC	900...1400 mcd	Screw	45-320.2E12	1	0.009 kg
amber	24-240 VAC/DC	450...1120 mcd	Screw	45-320.2F12	1	0.009 kg
yellow	24-240 VAC/DC	900...1400 mcd	Screw	45-320.2G12	1	0.009 kg
green	24-240 VAC/DC	900...1400 mcd	Screw	45-320.2H12	1	0.009 kg
blue	24-240 VAC/DC	280...710 mcd	Screw	45-320.2J12	1	0.009 kg
white	24-240 VAC/DC	900...1400 mcd	Screw	45-320.2N12	1	0.009 kg
red	24 VAC/DC	450...1120 mcd	Screw	45-320.2E16	1	0.009 kg
amber	24 VAC/DC	450...1120 mcd	Screw	45-320.2F16	1	0.009 kg
yellow	24 VAC/DC	900...1400 mcd	Screw	45-320.2G16	1	0.009 kg
green	24 VAC/DC	900...1400 mcd	Screw	45-320.2H16	1	0.009 kg
blue	24 VAC/DC	280...710 mcd	Screw	45-320.2J16	1	0.009 kg
white	24 VAC/DC	900...1400 mcd	Screw	45-320.2N16	1	0.009 kg
red	110 VAC	450...1120 mcd	Screw	45-320.2E17	1	0.009 kg
amber	110 VAC	450...1120 mcd	Screw	45-320.2F17	1	0.009 kg
yellow	110 VAC	900...1400 mcd	Screw	45-320.2G17	1	0.009 kg
green	110 VAC	900...1400 mcd	Screw	45-320.2H17	1	0.009 kg
blue	110 VAC	280...710 mcd	Screw	45-320.2J17	1	0.009 kg
white	110 VAC	900...1400 mcd	Screw	45-320.2N17	1	0.009 kg

LED colour	Operating voltage	Lichtstärke	Terminal	Part No.	Wiring diagram	Weight
red	230 VAC	450...1120 mcd	Screw	45-320.2E18	1	0.009 kg
amber	230 VAC	450...1120 mcd	Screw	45-320.2F18	1	0.009 kg
yellow	230 VAC	900...1400 mcd	Screw	45-320.2G18	1	0.009 kg
green	230 VAC	900...1400 mcd	Screw	45-320.2H18	1	0.009 kg
blue	230 VAC	280...710 mcd	Screw	45-320.2J18	1	0.009 kg
white	230 VAC	900...1400 mcd	Screw	45-320.2N18	1	0.009 kg



Illumination element

red	6-24 VAC/DC	450...1120 mcd	Spring-type terminal	45-320.2E41	1	0.009 kg
amber	6-24 VAC/DC	450...1120 mcd	Spring-type terminal	45-320.2F41	1	0.009 kg
yellow	6-24 VAC/DC	900...1400 mcd	Spring-type terminal	45-320.2G41	1	0.009 kg
green	6-24 VAC/DC	900...1400 mcd	Spring-type terminal	45-320.2H41	1	0.009 kg
blue	6-24 VAC/DC	280...710 mcd	Spring-type terminal	45-320.2J41	1	0.009 kg
white	6-24 VAC/DC	900...1400 mcd	Spring-type terminal	45-320.2N41	1	0.009 kg
red	24-240 VAC/DC	450...1120 mcd	Spring-type terminal	45-320.2E42	1	0.009 kg
amber	24-240 VAC/DC	450...1120 mcd	Spring-type terminal	45-320.2F42	1	0.009 kg
yellow	24-240 VAC/DC	900...1400 mcd	Spring-type terminal	45-320.2G42	1	0.009 kg
green	24-240 VAC/DC	900...1400 mcd	Spring-type terminal	45-320.2H42	1	0.009 kg
blue	24-240 VAC/DC	280...710 mcd	Spring-type terminal	45-320.2J42	1	0.009 kg
white	24-240 VAC/DC	900...1400 mcd	Spring-type terminal	45-320.2N42	1	0.009 kg
red	24 VAC/DC	450...1120 mcd	Spring-type terminal	45-320.2E46	1	0.009 kg
amber	24 VAC/DC	450...1120 mcd	Spring-type terminal	45-320.2F46	1	0.009 kg
yellow	24 VAC/DC	900...1400 mcd	Spring-type terminal	45-320.2G46	1	0.009 kg
green	24 VAC/DC	900...1400 mcd	Spring-type terminal	45-320.2H46	1	0.009 kg
blue	24 VAC/DC	280...710 mcd	Spring-type terminal	45-320.2J46	1	0.009 kg
white	24 VAC/DC	900...1400 mcd	Spring-type terminal	45-320.2N46	1	0.009 kg
red	110 VAC	450...1120 mcd	Spring-type terminal	45-320.2E47	1	0.009 kg
amber	110 VAC	450...1120 mcd	Spring-type terminal	45-320.2F47	1	0.009 kg
yellow	110 VAC	900...1400 mcd	Spring-type terminal	45-320.2G47	1	0.009 kg
green	110 VAC	900...1400 mcd	Spring-type terminal	45-320.2H47	1	0.009 kg
blue	110 VAC	280...710 mcd	Spring-type terminal	45-320.2J47	1	0.009 kg
white	110 VAC	900...1400 mcd	Spring-type terminal	45-320.2N47	1	0.009 kg
red	230 VAC	450...1120 mcd	Spring-type terminal	45-320.2E48	1	0.009 kg
amber	230 VAC	450...1120 mcd	Spring-type terminal	45-320.2F48	1	0.009 kg
yellow	230 VAC	900...1400 mcd	Spring-type terminal	45-320.2G48	1	0.009 kg
green	230 VAC	900...1400 mcd	Spring-type terminal	45-320.2H48	1	0.009 kg
blue	230 VAC	280...710 mcd	Spring-type terminal	45-320.2J48	1	0.009 kg
white	230 VAC	900...1400 mcd	Spring-type terminal	45-320.2N48	1	0.009 kg



Wiring diagram 1

Illumination element PCB mounting



Dimensions [mm]
 X = Screw terminal,
 SP = Spring-type terminal

LED colour	Operating voltage	Terminal	Part No.	Wiring diagram	Weight
 <p style="text-align: center;">Illumination element</p>					
red	5 VDC	PCB terminal	45-320.3E60	1	0.009 kg
amber	5 VDC	PCB terminal	45-320.3F60	1	0.009 kg
yellow	5 VDC	PCB terminal	45-320.3G60	1	0.009 kg
green	5 VDC	PCB terminal	45-320.3H60	1	0.009 kg
blue	5 VDC	PCB terminal	45-320.3J60	1	0.009 kg
white	5 VDC	PCB terminal	45-320.3N60	1	0.009 kg



Test module



Dimensions [mm]
 X = Screw terminal,
 SP = Spring-type terminal

Product attribute	Operating voltage	Terminal	Part No.	Wiring diagram	Weight
 Test module front mounting					
front plate mounting	12-240 VAC/DC	Screw	45-330.1115	1	0.011 kg
 Test module base mounting					
base mounting	12-240 VAC/DC	Screw	45-330.2115	1	0.011 kg



Extension plungers

Product attribute	Material	Colour	Part No.	Weight
 Extension plungers				
for pushbutton with extended stroke	Plastic	black	45-50M.1900	0.009 kg

Legend plate for switching elements

Additional Information

- Without inscription
- In support of the dust resistance



Dimensions [mm]

Product attribute	Dimension	Material	Colour	Part No.	Weight
 Legend plate					
for snapping in place	10.5 x 9.5 mm	Plastic	white	45-523.1900	0.001 kg

Mounting

Enclosure, IP66, IP67, IP69K

Additional Information

- Openings for cable gland M16 or M20



Dimensions [mm]

Product attribute	Dimension	Material	Colour	Part No.	Weight
 <p>Enclosure</p>					
1 mounting hole Ø 22.3 mm	L 85 x B 85 x H 64 mm	Plastic	grey	45-430.1801	0.251 kg
 <p>Enclosure</p>					
1 mounting hole Ø 22.3 mm	L 85 x B 85 x H 64 mm	Plastic	yellow	45-410.1401	0.248 kg
 <p>Enclosure</p>					
1 mounting hole Ø 22.3 mm, for base mounting, top and bottom 1 x M20	L 89.4 x B 85 x H 64 mm	Metal	yellow	45-410.2403	0.478 kg
 <p>Enclosure</p>					
1 mounting hole Ø 22.3 mm, for base mounting, top and bottom 1 x M20	L 89.4 x B 85 x H 64 mm	Metal	grey	45-430.2803	0.479 kg
 <p>Enclosure</p>					
1 mounting hole Ø 22.3 mm, with protective shroud	L 85 x B 85 x H 64 mm	Plastic	yellow	45-420.1401	0.287 kg
 <p>Enclosure</p>					
1 mounting hole Ø 22.3 mm, with protective shroud, for base mounting, top and bottom 1 x M20	L 89.4 x B 85 x H 64 mm	Metal	grey	45-420.2803	0.568 kg

Product attribute	Dimension	Material	Colour	Part No.	Weight
 <p>Enclosure</p>					
2 mounting holes Ø 22.3 mm	L 114 x B 85 x H 64 mm	Plastic	grey	45-440.1801	0.299 kg
2 mounting holes Ø 22.3 mm, for base mounting, top and bottom 1 x M20	L 118 x B 85 x H 64 mm	Metal	grey	45-440.2803	0.299 kg
 <p>Enclosure</p>					
3 mounting holes Ø 22.3 mm	L 154 x B 85 x H 64 mm	Plastic	grey	45-450.1801	0.364 kg
3 mounting holes Ø 22.3 mm, for base mounting, top and bottom 1 x M20	L 158 x B 85 x H 64 mm	Metal	grey	45-450.2803	0.683 kg
 <p>Enclosure</p>					
4 mounting holes Ø 22.3 mm	L 194 x B 85 x H 64 mm	Plastic	grey	45-460.1802	0.436 kg
4 mounting holes Ø 22.3 mm, for base mounting, top and bottom 1 x M20	L 199 x B 85 x H 64 mm	Metal	grey	45-460.2804	0.799 kg
 <p>Enclosure</p>					
6 mounting holes Ø 22.3 mm	L 280 x B 85 x H 64 mm	Plastic	grey	45-470.1802	0.602 kg
6 mounting holes Ø 22.3 mm, for base mounting, top and bottom 1 x M20	L 285 x B 85 x H 64 mm	Metal	grey	45-470.2804	1.081 kg

Cable gland, IP66, IP67, IP69K

Thread	Material	Colour	Part No.	Weight
 <p>Cable gland</p>				
M20	Plastic	black	45-507.1100	0.016 kg
M25	Plastic	black	45-509.1100	0.022 kg

Connection piece, IP 68

Product attribute	Thread	Material	Colour	Part No.	Weight
 Connection piece					
for connecting 2 enclosures, with hexagonal nut	M20/M20	Plastic	black	45-50C.1900	0.050 kg
 Connection piece					
for connecting 2 enclosures, with hexagonal nut	M20/M25	Plastic	black	45-50D.1900	0.055 kg
 Connection piece					
for connecting 2 enclosures, with hexagonal nut	M25/M25	Plastic	black	45-50E.1900	0.060 kg
 Connection piece					
for connecting 2 enclosures, with hexagonal nut	M20/M20	Metal	silver	45-50C.2900	0.055 kg
 Connection piece					
for connecting 2 enclosures, with hexagonal nut	M20/M25	Metal	silver	45-50D.2900	0.075 kg
 Connection piece					
for connecting 2 enclosures, with hexagonal nut	M25/M25	Metal	silver	45-50E.2900	0.077 kg

Enclosure cover monitoring

Product attribute	Material	Colour	Part No.	Weight
 Enclosure cover monitoring				
with extension plungers	Plastic	black	45-50G.0900	0.007 kg

Drawings



Dimensions incl. mounting depth of 3 or 4 elements

Indicator, Pushbutton, Illuminated pushbutton (flush design)



Keylock switch (flush design)



Selector switch short lever (flush design)



Selector switch long lever (flush design)



Indicator full face illumination (raised design)



Indicator front illumination, Pushbutton, Illuminated pushbutton, Lens level with front ring (raised design)



Pushbutton, Illuminated pushbutton, lens raised above front ring (raised design)



Pushbutton, lens lower than front ring (raised design)



45 Drawings

Pushbutton, Illuminated pushbutton, lens lower than front ring, with castellation (raised design)



Double pushbutton, Lens level with front ring (raised design)



Double pushbutton, level with/raised above front ring (raised design)



Emergency stop switch Ø 33.8 mm (raised design)



Emergency stop switch, Stop switch \varnothing 40 mm
(raised design)



Emergency stop switch, Stop switch \varnothing 40 mm
(raised design)



Emergency stop switch \varnothing 60 mm (raised design)



Emergency stop switch with key \varnothing 40 mm
(raised design)



45 Drawings

Stop switch \varnothing 29.5 mm (raised design)



Mushroom-head pushbutton \varnothing 30 mm (raised design)



Mushroom-head pushbutton Momentary, Maintain, \varnothing 40 mm (raised design)



Mushroom-head pushbutton Momentary/Maintain, Momentary/Momentary, \varnothing 40 mm (raised design)



Mushroom-head pushbutton Ø 60 mm (raised design)



Keylock switch (raised design)



Selector switch, round lever (raised design)



Selector switch, short lever (raised design)



Selector switch, long lever (raised design)



Potentiometer (raised design)



Toggle stick (raised design)



Toggle switch (raised design)



Indicator actuator
Material
Actuator element

Plastic

Front ring

Plastic or metal

Actuator housing

Plastic or metal

Mechanical characteristics
Vibration resistance

according to IEC 60068-2-6

2 ... 500 Hz: 5 g

Shock resistance

according to IEC 60068-2-27

Sinusoidal half-wave 50 g /11 ms

Environmental conditions
Operating temperature

-25 °C ... +70 °C

Storage temperature

-40 °C ... +80 °C

Protection degree

IP66, IP67, IP69K

Environmental category

during operation according to IEC 60721:

3K6, 3C3, 3S2, 3M6

Pushbutton actuator
Material
Actuator element

Plastic

Front ring

Plastic or metal

Actuator housing

Plastic or metal

Mechanical characteristics
Operating frequency

Lens flat/level with front bezel:

- Momentary max. 3 600/h

- Maintain max. 1 800/h

Lens flat/raised above front ring:

- Momentary max. 3 600/h

- Maintain max. 1 800/h

Lens flat/lower than front ring:

- Momentary max. 3 600/h

Lens flat/lower than front ring, with castellation:

- Momentary max. 3 600/h

Mechanical lifetime

Lens flat/level with front bezel:

- Momentary 10 000 000 switching cycles

- Maintain 500 000 switching cycles

Lens flat/raised above front ring:

- Momentary 10 000 000 switching cycles

- Maintain 500 000 switching cycles

Lens flat/lower than front ring:

- Momentary 10 000 000 switching cycles

Lens flat/lower than front ring, with castellation:

- Momentary 10 000 000 switching cycles

Vibration resistance

according to IEC 60068-2-6

20 ... 500 Hz: 5 g

Shock resistance

according to IEC 60068-2-27

Sinusoidal half-wave 50 g /11 ms

Environmental conditions
Operating temperature

-25 °C ... +70 °C

Storage temperature

-40 °C ... +80 °C

Protection degree

IP66, IP67, IP69K

Environmental category

during operation according to IEC 60721:

3K6, 3C3, 3S2, 3M6

45 Technical data

Double pushbutton actuator, Double pushbutton actuator illuminated

Material

Actuator element

Plastic

Front ring

Plastic or metal

Actuator housing

Plastic or metal

Mechanical characteristics

Operating frequency

max. 3 600/h

Mechanical lifetime

2 000 000 switching cycles

Vibration resistance

according to IEC 60068-2-6
10 ... 500 Hz: 5 g

Shock resistance

according to IEC 60068-2-27
Sinusoidal half-wave 50 g /11 ms

Environmental conditions

Operating temperature

-25 °C ... +70 °C

Storage temperature

-40 °C ... +80 °C

Protection degree

IP66, IP67, IP69K

Environmental category

during operation according to IEC 60721:
3K6, 3C3, 3S2, 3M6, 2B2

Illuminated pushbutton actuator

Material

Actuator element

Plastic

Front ring

Plastic or metal

Actuator housing

Plastic or metal

Mechanical characteristics

Operating frequency

Lens flat/level with front bezel:
- Momentary max. 3 600/h
- Maintain max. 1 800/h
Lens flat/raised above front ring:
- Momentary max. 3 600/h
Lens flat/lower than front ring, with castellation:
- Momentary max. 3 600/h

Mechanical lifetime

Lens flat/level with front bezel:
- Momentary 3 000 000 switching cycles
- Maintain 500 000 switching cycles
Lens flat/raised above front ring:
- Momentary 3 000 000 switching cycles
Lens flat/lower than front ring, with castellation:
- Momentary 3 000 000 switching cycles

Vibration resistance

according to IEC 60068-2-6
20 ... 500 Hz: 5 g

Shock resistance

according to IEC 60068-2-27
Sinusoidal half-wave 50 g /11 ms

Environmental conditions

Operating temperature

-25 °C ... +70 °C

Storage temperature

-40 °C ... +80 °C

Protection degree

IP66, IP67, IP69K

Environmental category

during operation according to IEC 60721:
3K6, 3C3, 3S2, 3M6

Emergency stop switch actuator

Material

Actuator element

Plastic red

Actuator housing

Plastic or metal

Mechanical characteristics

Type of unlocking device

Twist to release, pull release or key to release

Operating frequency

max. 600/h

Mechanical lifetime

300 000 switching cycles

Vibration resistance

according to IEC 60068-2-6
2 ... 500 Hz: 5 g

Shock resistance

according to IEC 60068-2-27
Sinusoidal half-wave 50 g /11 ms

Environmental conditions

Operating temperature

-25 °C ... +70 °C

Storage temperature

-40 °C ... +80 °C

Protection degree

IP66, IP67, IP69K

Environmental category

during operation according to IEC 60721:
3K6, 3C3, 3S2, 3M6

Stop switch actuator

Material

Actuator element

Plastic red

Actuator housing

Plastic or metal

Mechanical characteristics

Type of unlocking device

Twist to release

Operating frequency

max. 600/h

Mechanical lifetime

300 000 switching cycles

Vibration resistance

according to IEC 60068-2-6
2 ... 500 Hz: 5 g

Shock resistance

according to IEC 60068-2-27
Sinusoidal half-wave 50 g /11 ms

Environmental conditions

Operating temperature

-25 °C ... +70 °C

Storage temperature

-40 °C ... +80 °C

Protection degree

IP66, IP67, IP69K

Environmental category

during operation according to IEC 60721:
3K6, 3C3, 3S2, 3M6

Mushroom-head pushbutton actuator

Material

Actuator element

Plastic

Actuator housing

Plastic or metal

Mechanical characteristics

Type of unlocking device

Pull release

Operating frequency

- Momentary max. 3 600/h
- Maintain max. 1 800/h

Mechanical lifetime

- Momentary 10 000 000 switching cycles
- Maintain 500 000 switching cycles

Vibration resistance

according to IEC 60068-2-6
20 ... 500 Hz: 5 g

Shock resistance

according to IEC 60068-2-27
Sinusoidal half-wave 50 g /11 ms

Environmental conditions

Operating temperature

-25 °C ... +70 °C

Storage temperature

-40 °C ... +80 °C

Protection degree

IP66, IP67, IP69K

Environmental category

during operation according to IEC 60721:
3K6, 3C3, 3S2, 3M6

Keylock switch actuator

Material

Actuator element

Metal

Front ring

Plastic or metal

Actuator housing

Plastic or metal

Mechanical characteristics

Operating frequency

max. 1800/h

Mechanical lifetime

1 000 000 switching cycles

Vibration resistance

according to IEC 60068-2-6
10 ... 500 Hz: 5 g

Shock resistance

according to IEC 60068-2-27
Sinusoidal half-wave 50 g /11 ms

Environmental conditions

Operating temperature

-25 °C ... +70 °C

Storage temperature

-40 °C ... +80 °C

Protection degree

IP66, IP67, IP69K

Environmental category

during operation according to IEC 60721:
3K6, 3C3, 3S2, 3M6

Selector switch actuator
Material
Actuator element

Round lever, plastic, illuminable
 Short lever, plastic, illuminable
 Long lever, plastic, illuminable

Front ring

Plastic or metal

Actuator housing

Plastic or metal

Mechanical characteristics
Operating frequency

max. 1800/h

Mechanical lifetime

1 000 000 switching cycles

Vibration resistance

according to IEC 60068-2-6
 10 ... 500 Hz: 5 g

Shock resistance

according to IEC 60068-2-27
 Sinusoidal half-wave 50 g /11 ms

Environmental conditions
Operating temperature

-25 °C ... +70 °C

Storage temperature

-40 °C ... +80 °C

Protection degree

IP66, IP67, IP69K

Environmental category

during operation according to IEC 60721:
 3K6, 3C3, 3S2, 3M6

Potentiometer
Material
Actuator element

Round lever, plastic

Front ring

Plastic or metal

Actuator housing

Plastic or metal

Mechanical characteristics
Terminals

Screw terminal
 - Solid 2 x (1.0 ... 1.5 mm²)
 - With end sleeves 2 x (0.5 ... 0.75 mm²)
 - Finely stranded
 - Without end sleeves 2 x (0.5 ... 0.75 mm²)
 - With end sleeves 2 x (0.5 ... 1.5 mm²)
 - For AWG cables for auxiliary contacts 2 x (18 ... 14)

Tightening torque

0.8 ... 1 Nm

Operating frequency

max. 1 800/h

Mechanical lifetime

25 000 switching cycles

Vibration resistance

according to IEC 60068-2-6
 10 ... 500 Hz: 5 g

Shock resistance

according to IEC 60068-2-27
 Sinusoidal half-wave 50 g /11 ms

Slewing range

275° ±2°

Electrical characteristics
Active power consumption

0.5 W

Insulation voltage

Rated value 500 V

Environmental conditions

Operating temperature

-25 °C ... +70 °C

Storage temperature

-40 °C ... +80 °C

Protection degree

IP66, IP67, IP69K

Environmental category

during operation according to IEC 60721:

3K6, 3C3, 3S2, 3M6

Toggle stick actuator

Material

Actuator element

Plastic

Front ring

Plastic or metal

Actuator housing

Plastic or metal

Mechanical characteristics

Operating frequency

3 600/h

Mechanical lifetime

Momentary: 250 000 switching cycles

Vibration resistance

according to IEC 60068-2-6

10 ... 500 Hz: 5 g

Shock resistance

according to IEC 60068-2-27

Sinusoidal half-wave 50 g /11 ms

Environmental conditions

Operating temperature

-25 °C ... +70 °C

Storage temperature

-40 °C ... +80 °C

Protection degree

IP65, IP67

Environmental category

during operation according to IEC 60721:

3K6, 3C3, 3S2, 3M6

Toggle switch actuator
Material
Actuator element

Plastic

Front ring

Plastic or metal

Actuator housing

Plastic or metal

Mechanical characteristics
Operating frequency

max. 1 800/h

Mechanical lifetime

1 000 000 switching cycles

Vibration resistance

according to IEC 60068-2-6

10 ... 500 Hz: 5 g

Shock resistance

according to IEC 60068-2-27

Sinusoidal half-wave 50 g /11 ms

Environmental conditions
Operating temperature

-25 °C ... +70 °C

Storage temperature

-40 °C ... +80 °C

Protection degree

IP66, IP67, IP69K

Environmental category

during operation according to IEC 60721:

3K6, 3C3, 3S2, 3M6

Slow-make switching element
Switching system

The double-break, slow-make switching element is equipped with normally open or normally closed contact. The normally closed contact has forced opening. Slow-make contacts with forced action are ideal for high switch ratings. Up to six switching elements can be snapped to each holder.

The NC contact opens automatically upon disconnection of the actuator. On delivery, the contact is open (= safe state).

Activation (= NC contacts on the non-actuated commanding device are closed) takes place upon first-time actuation after the contact block is snapped onto the actuator.

Material
Material of contact

Silver alloy

Housing

Plastic

Mechanical characteristics
Terminals

Screw terminal

- Solid 2 x (1.0 ... 1.5 mm²)
- With end sleeves 2 x (0.5 ... 0.75 mm²)
- Finely stranded
- Without end sleeves 2 x (0.5 ... 0.75 mm²)
- With end sleeves 2 x (0.5 ... 1.5 mm²)
- For AWG cables for auxiliary contacts 2 x (18 ... 14)

Spring-type terminal (SP)

- Solid 2 x (0.25 ... 1.5 mm²)
- Finely stranded
- Without end sleeves 2 x (0.5 ... 1.5 mm²)
- With end sleeves 2 x (0.5 ... 0.75 mm²)
- For AWG cables for auxiliary contacts 2 x (24 ... 16)

Tightening torque

Screw terminal, spring-type terminal 0.8 ... 0.9 Nm

Operating frequency

max. 3 600/h

Mechanical lifetime

10 000 000 switching cycles

Vibration resistance

according to IEC 60068-2-6

2 ... 500 Hz: 5 g

Shock resistance

according to IEC 60068-2-27

Sinusoidal half-wave 50 g /11 ms

Electrical characteristics

Standards

The switches comply with the "Standards for low-voltage switching devices" EN IEC 60947-5-1

Thermal current

10 A

Insulation voltage

Rated value 500 V

Pollution degree

3

Surge voltage resistance

Rated value 6 kV

Contact reliability

One contact failure per 100 million switching operations

(17 V, 5 mA)

One contact failure per 10 million switching operations (5 V, 1 mA)

Operating voltage

at AC

- Rated value 5 ... 500 V

at DC

- Rated value 5 ... 500 V

Operating current

at AC-12

Voltage	24 V	230 V	500 V
---------	------	-------	-------

Current	10 A	10 A	10 A
---------	------	------	------

at AC-15

Voltage	24V	230 V	400 V	500 V
---------	-----	-------	-------	-------

Current	6 A	6 A	3 A	1.4 A
---------	-----	-----	-----	-------

at DC-12

Voltage	24 V	48 V	110 V	230 V	400 V	500 V
---------	------	------	-------	-------	-------	-------

Current	10 A	5 A	2.5 A	1 A	0.3 A	0.2 A
---------	------	-----	-------	-----	-------	-------

at DC-13

Voltage	24 V	48 V	110 V	230 V	400 V	500 V
---------	------	------	-------	-------	-------	-------

Current	3 A	1.5 A	0.7 A	0.3 A	0.1 A	0.07 A
---------	-----	-------	-------	-------	-------	--------

Environmental conditions

Operating temperature

-25 °C ... +70 °C

Storage temperature

-40 °C ... +80 °C

Protection degree

Housing IP40

Terminal IP20

Environmental category

during operation according to IEC 60721:

3K6, 3C3, 3S2, 3M6

Approvals

Approbations

CCC

CSA

UL

Illumination element
Material
Housing

Plastic

Mechanical characteristics
Terminals

Screw terminal

- Solid 2 x (1.0 ... 1.5 mm²)
- With end sleeves 2 x (0.5 ... 0.75 mm²)
- Finely stranded
- Without end sleeves 2 x (0.5 ... 0.75 mm²)
- With end sleeves 2 x (0.5 ... 1.5 mm²)
- For AWG cables for auxiliary contacts 2 x (18 ... 14)

Spring-type terminal (SP)

- Solid 2 x (0.25 ... 1.5 mm²)
- Finely stranded
- Without end sleeves 2 x (0.5 ... 1.5 mm²)
- With end sleeves 2 x (0.5 ... 0.75 mm²)
- For AWG cables for auxiliary contacts 2 x (24 ... 16)

Tightening torque

Screw terminal, spring-type terminal 0.8 ... 0.9 Nm

Shock resistance

according to IEC 60068-2-27
Sinusoidal half-wave 50 g /11 ms

Vibration resistance

according to IEC 60068-2-6
2 ... 500 Hz: 5 g

Electrical characteristics
Standards

The switches comply with the "Standards for low-voltage switching devices" EN IEC 60947-5-1

Electrical life

100 000 h

Insulation voltage

Rated value 320 V

Surge voltage resistance

Rated value 4 kV

Environmental conditions
Operating temperature

-25 °C ... +70 °C

Storage temperature

-40 °C ... +80 °C

Protection degree

Terminal IP20

Environmental category

during operation according to IEC 60721:
3K6, 3C3, 3S2, 3M6

Approvals
Approbations

CCC
CSA
UL

Declaration of conformity

CE

EAO reserves the right to alter specifications without further notice.

Inscription marking plates and legend plates

Labels can be inserted for identification purposes in illuminated pushbuttons and pushbuttons with a flat lens. This marking plates are made of translucent plastic with a black inscription, which can be fitted in any 90° angle.

Standard texts for marking plates

Example		Part No. 45-563.0K00.T00029
----------------	---	-----------------------------

Standard texts German		Standard texts English	
Ein	Part No. 45-563.0K00.T00001	On	Part No. 45-563.0K00.T00020
Aus	Part No. 45-563.0K00.T00002	Off	Part No. 45-563.0K00.T00021
Auf	Part No. 45-563.0K00.T00003	Up	Part No. 45-563.0K00.T00022
Ab	Part No. 45-563.0K00.T00004	Down	Part No. 45-563.0K00.T00023
Vor	Part No. 45-563.0K00.T00005	Forward	Part No. 45-563.0K00.T00024
Zurück	Part No. 45-563.0K00.T00006	Right	Part No. 45-563.0K00.T00026
Rechts	Part No. 45-563.0K00.T00007	Left	Part No. 45-563.0K00.T00027
Links	Part No. 45-563.0K00.T00008	Stop	Part No. 45-563.0K00.T00028
Halt	Part No. 45-563.0K00.T00009	Start	Part No. 45-563.0K00.T00029
Zu	Part No. 45-563.0K00.T00010	Reset	Part No. 45-563.0K00.T00030
Schnell	Part No. 45-563.0K00.T00011	Test	Part No. 45-563.0K00.T00031
Langsam	Part No. 45-563.0K00.T00012	Open	Part No. 45-563.0K00.T00032
Betrieb	Part No. 45-563.0K00.T00013	Close	Part No. 45-563.0K00.T00033
Störung	Part No. 45-563.0K00.T00014	Running	Part No. 45-563.0K00.T00035
Einrichten	Part No. 45-563.0K00.T00018	Fast	Part No. 45-563.0K00.T00044
		Slow	Part No. 45-563.0K00.T00045

Symbols for marking plates

Graphic symbols are according to ISO 7000 or IEC 60417.

 Part No. 45-563.0K00.S00001	 Part No. 45-563.0K00.S00012 Decrease, Minus	 Part No. 45-563.0K00.S00023 Unlock
 Part No. 45-563.0K00.S00002	 Part No. 45-563.0K00.S00013 Electric motor	 Part No. 45-563.0K00.S00024 Setting
 Part No. 45-563.0K00.S00003	 Part No. 45-563.0K00.S00014 Horn	 Part No. 45-563.0K00.S00025 On-Off momentary contact type
 Part No. 45-563.0K00.S00004	 Part No. 45-563.0K00.S00015 Water tap	 Part No. 45-563.0K00.S00026 Manual operating
 Part No. 45-563.0K00.S00005 Arrow direction to right	 Part No. 45-563.0K00.S00016 Pump	 Part No. 45-563.0K00.S00027 Automatic cycle
 Part No. 45-563.0K00.S00006 Arrow direction up	 Part No. 45-563.0K00.S00017 Coolant pump	 Part No. 45-563.0K00.S00028 Suction
 Part No. 45-563.0K00.S00007 Clockwise rotation	 Part No. 45-563.0K00.S00018 Lock, tighten	 Part No. 45-563.0K00.S00029 Blowing
 Part No. 45-563.0K00.S00008 Counterclockwise rotation	 Part No. 45-563.0K00.S00019 Unlock, unclamp	
 Part No. 45-563.0K00.S00009 Rapid traverse	 Part No. 45-563.0K00.S00020 Brake	
 Part No. 45-563.0K00.S00010 Feed	 Part No. 45-563.0K00.S00021 Release brake	
 Part No. 45-563.0K00.S00011 Increase, Plus	 Part No. 45-563.0K00.S00022 Interlock	

Customized inscription for marking plates

All dimensions in mm

Height of letters h	Number of lines	Number of letters per line (target value)		
		b1	b2	b3
4	1	10	-	-
3	2	-	8	-
	3	10	-	6



The gap between two words results in each case a letter less.

Standard texts for legend plates black, 27 x 12.5 mm

Example	Reset	Part No. 45-573.1102.T00030
----------------	--------------	-----------------------------

Standard texts German		Standard texts English		Standard texts French	
Ein	Part No. 45-573.1102.T00001	On	Part No. 45-573.1102.T00020	Marche	Part No. 45-573.1102.T00048
Aus	Part No. 45-573.1102.T00002	Off	Part No. 45-573.1102.T00021	Arrêt	Part No. 45-573.1102.T00049
Auf	Part No. 45-573.1102.T00003	Up	Part No. 45-573.1102.T00022	Montée	Part No. 45-573.1102.T00050
Ab	Part No. 45-573.1102.T00004	Down	Part No. 45-573.1102.T00023	Descente	Part No. 45-573.1102.T00051
Vor	Part No. 45-573.1102.T00005	Forward	Part No. 45-573.1102.T00024	Avant	Part No. 45-573.1102.T00052
Zurück	Part No. 45-573.1102.T00006	Reverse	Part No. 45-573.1102.T00025	Retour	Part No. 45-573.1102.T00053
Rechts	Part No. 45-573.1102.T00007	Right	Part No. 45-573.1102.T00026	Droite	Part No. 45-573.1102.T00054
Links	Part No. 45-573.1102.T00008	Left	Part No. 45-573.1102.T00027	Gauche	Part No. 45-573.1102.T00055
Halt	Part No. 45-573.1102.T00009	Stop	Part No. 45-573.1102.T00028	Ouvert	Part No. 45-573.1102.T00056
Zu	Part No. 45-573.1102.T00010	Start	Part No. 45-573.1102.T00029	Fermé	Part No. 45-573.1102.T00057
Betrieb	Part No. 45-573.1102.T00013	Reset	Part No. 45-573.1102.T00030	Rapide	Part No. 45-573.1102.T00058
Störung	Part No. 45-573.1102.T00014	Test	Part No. 45-573.1102.T00031	En Service	Part No. 45-573.1102.T00059
Hand Auto	Part No. 45-573.1102.T00015	Open	Part No. 45-573.1102.T00032	Default	Part No. 45-573.1102.T00060
Hand O Auto	Part No. 45-573.1102.T00017	Close	Part No. 45-573.1102.T00033	Reglage	Part No. 45-573.1102.T00061
		Jog	Part No. 45-573.1102.T00034	Arrêt d'urgence	Part No. 45-573.1102.T00062
		Running	Part No. 45-573.1102.T00035	Hors service	Part No. 45-573.1102.T00063
		Fault	Part No. 45-573.1102.T00036	Sous tension	Part No. 45-573.1102.T00064
		Run	Part No. 45-573.1102.T00037	Manu Auto	Part No. 45-573.1102.T00065
		Stop Start	Part No. 45-573.1102.T00038	Marche Arrêt	Part No. 45-573.1102.T00066
		Off On	Part No. 45-573.1102.T00039	Rearmement	Part No. 45-573.1102.T00067
		Power off	Part No. 45-573.1102.T00040		
		Power on	Part No. 45-573.1102.T00041		
		Man O Auto	Part No. 45-573.1102.T00042		
		Man Auto	Part No. 45-573.1102.T00043		

Symbols for legend plates black, 27 x 12.5 mm

Graphic symbols are according to ISO 7000 or IEC 60417.

	Part No. 45-573.1102.S00001		Part No. 45-573.1102.S00007
	Part No. 45-573.1102.S00002		Part No. 45-573.1102.S00009 Arrow/Direction up
	Part No. 45-573.1102.S00005		

Standard texts for legend plates silver, 27 x 12.5 mm

Example	Reset	Part No. 45-573.1A02.T00030
----------------	--------------	-----------------------------

Standard texts German		Standard texts English	
Ein	Part No. 45-573.1A02.T00001	On	Part No. 45-573.1A02.T00020
Aus	Part No. 45-573.1A02.T00002	Off	Part No. 45-573.1A02.T00021
Auf	Part No. 45-573.1A02.T00003	Up	Part No. 45-573.1A02.T00022
Ab	Part No. 45-573.1A02.T00004	Down	Part No. 45-573.1A02.T00023
Vor	Part No. 45-573.1A02.T00005	Stop	Part No. 45-573.1A02.T00028
Zurück	Part No. 45-573.1A02.T00006	Start	Part No. 45-573.1A02.T00029
Rechts	Part No. 45-573.1A02.T00007	Reset	Part No. 45-573.1A02.T00030
Links	Part No. 45-573.1A02.T00008	Test	Part No. 45-573.1A02.T00031
Halt	Part No. 45-573.1A02.T00009	Open	Part No. 45-573.1A02.T00032
Zu	Part No. 45-573.1A02.T00010	Close	Part No. 45-573.1A02.T00033
Schnell	Part No. 45-573.1A02.T00011	Man O Auto	Part No. 45-573.1A02.T00042
Langsam	Part No. 45-573.1A02.T00012	Man Auto	Part No. 45-573.1A02.T00043
Betrieb	Part No. 45-573.1A02.T00013	Running	Part No. 45-573.1A02.T00035
Störung	Part No. 45-573.1A02.T00014	Fault	Part No. 45-573.1A02.T00036
Hand Auto	Part No. 45-573.1A02.T00015	Fast	Part No. 45-573.1A02.T00044
Stop Start	Part No. 45-573.1A02.T00016	Slow	Part No. 45-573.1A02.T00045
Hand O Auto	Part No. 45-573.1A02.T00017		

Symbols for legend plates silver, 27 x 12.5 mm

Graphic symbols are according to ISO 7000 or IEC 60417.

	Part No. 45-573.1A02.S00001		Part No. 45-573.1A02.S00006
	Part No. 45-573.1A02.S00002		Part No. 45-573.1A02.S00007
	Part No. 45-573.1A02.S00003		Part No. 45-573.1A02.S00008 Arrow/Direction right
	Part No. 45-573.1A02.S00004		Part No. 45-573.1A02.S00009 Arrow/Direction up
	Part No. 45-573.1A02.S00005		

45 Marking

Standard texts for legend plates black, 27 x 17.5 mm

Example		Part No. 45-573.1103.T00028
----------------	---	-----------------------------

Standard texts German		Standard texts English		Standard texts French	
Ein	Part No. 45-573.1103.T00001	On	Part No. 45-573.1103.T00020	Marche	Part No. 45-573.1103.T00048
Aus	Part No. 45-573.1103.T00002	Off	Part No. 45-573.1103.T00021	Arrêt	Part No. 45-573.1103.T00049
Auf	Part No. 45-573.1103.T00003	Up	Part No. 45-573.1103.T00022	Droite	Part No. 45-573.1103.T00054
Ab	Part No. 45-573.1103.T00004	Down	Part No. 45-573.1103.T00023	Gauche	Part No. 45-573.1103.T00055
Vor	Part No. 45-573.1103.T00005	Forward	Part No. 45-573.1103.T00024	En Service	Part No. 45-573.1103.T00059
Zurück	Part No. 45-573.1103.T00006	Reverse	Part No. 45-573.1103.T00025	Defaut	Part No. 45-573.1103.T00060
Halt	Part No. 45-573.1103.T00009	Right	Part No. 45-573.1103.T00026	Sous tension	Part No. 45-573.1103.T00064
Zu	Part No. 45-573.1103.T00010	Stop	Part No. 45-573.1103.T00028	Manu Auto	Part No. 45-573.1103.T00065
Betrieb	Part No. 45-573.1103.T00011	Start	Part No. 45-573.1103.T00029	Marche Arrêt	Part No. 45-573.1103.T00066
Störung	Part No. 45-573.1103.T00014	Open	Part No. 45-573.1103.T00032	Rearmement	Part No. 45-573.0K00.T00067
Hand Auto	Part No. 45-573.1103.T00015	Close	Part No. 45-573.1103.T00033		
		Running	Part No. 45-573.1103.T00035		
		Fault	Part No. 45-573.1103.T00036		
		Stop Start	Part No. 45-573.1103.T00038		
		Man Auto	Part No. 45-573.1103.T00043		

Symbols for legend plates black, 27 x 12.5 mm

Graphic symbols are according to ISO 7000 or IEC 60417.

	Part No. 45-573.1103.S00001		Part No. 45-573.1103.S00008 Arrow/Direction right
	Part No. 45-573.1103.S00002		Part No. 45-573.1103.S00009 Arrow/Direction up
	Part No. 45-573.1103.S00005		

Standard texts for legend plates silver, 27 x 17.5 mm

Example		Part No. 45-573.1A03.T00028
----------------	---	-----------------------------

Standard texts German		Standard texts English	
Ein	Part No. 45-573.1A03.T00001	On	Part No. 45-573.1A03.T00020
Aus	Part No. 45-573.1A03.T00002	Off	Part No. 45-573.1A03.T00021
Auf	Part No. 45-573.1A03.T00003	Stop	Part No. 45-573.1A03.T00028
Ab	Part No. 45-573.1A03.T00004	Start	Part No. 45-573.1A03.T00029
Vor	Part No. 45-573.1A03.T00005	Reset	Part No. 45-573.1A03.T00030
Zurück	Part No. 45-573.1A03.T00006	Fault	Part No. 45-573.1A03.T00036
Rechts	Part No. 45-573.1A03.T00007	Man O Auto	Part No. 45-573.1A03.T00043
Halt	Part No. 45-573.1A03.T00009		
Zu	Part No. 45-573.1A03.T00010		
Betrieb	Part No. 45-573.1A03.T00013		
Störung	Part No. 45-573.1A03.T00014		
Hand Auto	Part No. 45-573.1A03.T00015		
Hand O Auto	Part No. 45-573.1A03.T00017		

Symbols for legend plates silver, 27 x 17.5 mm

Graphic symbols are according to ISO 7000 or IEC 60417.

	Part No. 45-573.1A02.S00001		Part No. 45-573.1A02.S00007
	Part No. 45-573.1A02.S00002		Part No. 45-573.1A02.S00008 Arrow/Direction right
	Part No. 45-573.1A02.S00005		Part No. 45-573.1A02.S00009 Arrow/Direction up

Standard texts for legend plates black, 27 x 27 mm

Example		Part No. 45-573.1103.T00028
----------------	---	-----------------------------

Standard texts German		Standard texts English		Standard texts French	
Ein	Part No. 45-573.1105.T00001	On	Part No. 45-573.1105.T00020	Marche	Part No. 45-573.1105.T00048
Aus	Part No. 45-573.1105.T00002	Off	Part No. 45-573.1105.T00021	Arrêt	Part No. 45-573.1105.T00049
Auf	Part No. 45-573.1105.T00003	Up	Part No. 45-573.1105.T00022	Montée	Part No. 45-573.1105.T00050
Ab	Part No. 45-573.1105.T00004	Down	Part No. 45-573.1105.T00023	Descente	Part No. 45-573.1105.T00051
Vor	Part No. 45-573.1105.T00005	Forward	Part No. 45-573.1105.T00024	En Service	Part No. 45-573.1105.T00059
Zurück	Part No. 45-573.1105.T00006	Reverse	Part No. 45-573.1105.T00025	Defaut	Part No. 45-573.1105.T00060
Rechts	Part No. 45-573.1105.T00007	Stop	Part No. 45-573.1105.T00028	Sous tension	Part No. 45-573.1105.T00064
Links	Part No. 45-573.1105.T00008	Start	Part No. 45-573.1105.T00029	Manu Auto	Part No. 45-573.1105.T00065
Halt	Part No. 45-573.1105.T00009	Stop Start	Part No. 45-573.1105.T00038	Marche Arrêt	Part No. 45-573.1105.T00066
Zu	Part No. 45-573.1105.T00010	EMERGENCY STOP	Part No. 45-573.1105.T00046		
Betrieb	Part No. 45-573.1105.T00013				
Störung	Part No. 45-573.1105.T00014				
Hand Auto	Part No. 45-573.1105.T00015				

Symbols for legend plates black, 27 x 27 mm

Graphic symbols are according to ISO 7000 or IEC 60417.

	Part No. 45-573.1105.S00003		Part No. 45-573.1105.S00008 Arrow/Direction right
---	-----------------------------	---	--

Customized inscription for legend plates

All dimensionen in mm

Size of legend plates	Height of letters	Number of lines
27 x 12.5	4	1
	3.5	2
	2.5	3
27 x 17.5	4	1 – 2
	3	3
27 x 27	4	1 – 5

Up to 11 characters per line are possible.

Suppressor circuits

When switching inductive loads such as relays, DC motors, and DC solenoids, it is always important to absorb surges (e.g. with a diode) to protect the contacts. When these inductive loads are switched off, a counter emf can severely damage switch contacts and greatly shorten lifetime.

Fig. 1 shows an inductive load with a free-wheeling diode connected in parallel. This free-wheeling diode provides a path for the inductor current to flow when the current is interrupted by the switch. Without this free-wheeling diode, the voltage across the coil will be limited only by dielectric breakdown voltages of the circuit or parasitic elements of the coil. This voltage can be kilovolts in amplitude even when nominal circuit voltages are low (e.g. 12VDC) see Fig. 2.

The free-wheeling diode should be chosen so that the reverse breakdown voltage is greater than the voltage driving the inductive load. The DC blocking voltage (V_R) of the free-wheeling diode can be found in the datasheet of a diode. The forward current should be equal or greater than the maximum current flowing through the load.

To get an efficient protection, the free-wheeling diode must be connected as close as possible to the inductive load!

Switching with inductive load
Fig. 1



Counter EMF
over load without free-wheeling diode
Fig. 2



Part No.	Page	Part No.	Page	Part No.	Page	Part No.	Page	Part No.	Page
45-2910.1000.113 ...	86	45-2P05.1E10.000.	107	45-320.1H42.....	135	45-320.2N17.....	136	45-548.1K00.....	123
45-2910.2000.113 ...	87	45-2P05.2E10.000.	107	45-320.1H46.....	135	45-320.2N18.....	137	45-549.1400.....	125
45-2911.1000.113 ...	86	45-2P06.1E10.000.	107	45-320.1H47.....	135	45-320.2N41.....	137	45-549.1800.....	125
45-2911.2000.113 ...	87	45-2P06.2E10.000.	107	45-320.1H48.....	135	45-320.2N42.....	137	45-550.1400.....	125
45-2911.3000.113 ...	87	45-2T00.10E0.000...	34	45-320.1J11.....	134	45-320.2N46.....	137	45-552.0100.....	113
45-2917.1000.113 ...	86	45-2T00.10F0.000...	34	45-320.1J12.....	134	45-320.2N47.....	137	45-552.0200.....	114
45-2917.2000.113 ...	87	45-2T00.10G0.000...	34	45-320.1J16.....	134	45-320.2N48.....	137	45-552.0400.....	114
45-2917.3000.113 ...	87	45-2T00.10H0.000...	34	45-320.1J17.....	134	45-320.3E60.....	138	45-552.0500.....	114
45-2922.1000.113 ...	86	45-2T00.10J0.000...	34	45-320.1J18.....	135	45-320.3F60.....	138	45-552.0E00.....	114
45-2922.2000.113 ...	87	45-2T00.10K0.000...	35	45-320.1J41.....	135	45-320.3G60.....	138	45-552.0G00.....	114
45-2922.3000.113 ...	87	45-2T00.10N0.000...	35	45-320.1J42.....	135	45-320.3H60.....	138	45-552.0H00.....	114
45-2924.1000.113 ...	86	45-2T00.20E0.000...	35	45-320.1J46.....	135	45-320.3J60.....	138	45-552.0J00.....	114
45-2924.2000.113 ...	87	45-2T00.20F0.000...	35	45-320.1J47.....	135	45-320.3N60.....	138	45-552.0K00.....	114
45-2924.3000.113 ...	87	45-2T00.20G0.000...	35	45-320.1J48.....	135	45-330.1115.....	139	45-553.0100.....	112
45-2925.1000.111 ...	84	45-2T00.20H0.000...	35	45-320.1N11.....	134	45-330.2115.....	139	45-553.0200.....	112
45-2925.2000.111 ...	85	45-2T00.20J0.000...	35	45-320.1N12.....	134	45-410.1401.....	141	45-553.0400.....	112
45-2925.3000.111 ...	84	45-2T00.20K0.000...	35	45-320.1N16.....	134	45-410.2403.....	141	45-553.0500.....	112
45-2C35.1920.110... 62		45-2T00.20N0.000...	35	45-320.1N17.....	134	45-420.1401.....	141	45-553.0600.....	112
45-2C36.1820.000... 61		45-2T07.10E0.000...	36	45-320.1N18.....	135	45-420.2803.....	141	45-553.0900.....	112
45-2C36.1920.000... 62		45-2T07.10G0.000...	36	45-320.1N41.....	135	45-430.1801.....	141	45-553.0E00.....	112
45-2C36.1A20.000.. 62		45-2T07.10H0.000...	36	45-320.1N42.....	135	45-430.2803.....	141	45-553.0F00.....	113
45-2C37.1920.000... 62		45-2T07.10J0.000...	36	45-320.1N46.....	135	45-440.1801.....	142	45-553.0G00.....	113
45-2D36.1820.000... 61		45-2T07.10K0.000...	36	45-320.1N47.....	135	45-440.2803.....	142	45-553.0H00.....	113
45-2D36.1920.000... 62		45-2T07.30E0.000...	37	45-320.1N48.....	135	45-450.1801.....	142	45-553.0J00.....	113
45-2D36.1A20.000.. 62		45-2T07.30G0.000...	37	45-320.2E11.....	136	45-450.2803.....	142	45-553.0K00.....	113
45-2D36.2820.000... 62		45-2T07.30H0.000...	37	45-320.2E12.....	136	45-460.1802.....	142	45-553.0N00.....	113
45-2F0T.1010.000.. 110		45-2T07.30J0.000...	37	45-320.2E16.....	136	45-460.2804.....	142	45-555.1100.....	122
45-2F0T.2010.000.. 110		45-2T07.30K0.000...	37	45-320.2E17.....	136	45-470.1802.....	142	45-555.1K00.....	122
45-2F0T.3010.000.. 110		45-2T07.4FE0.000...	20	45-320.2E18.....	137	45-470.2804.....	142	45-558.0000.....	122
45-2F0V.1010.000.. 110		45-2T07.4FG0.000...	20	45-320.2E41.....	137	45-506.1100.....	127	45-560.1100.....	127
45-2F0V.2010.000.. 110		45-2T07.4FH0.000...	20	45-320.2E42.....	137	45-506.2A00.....	127	45-561.1400.....	118
45-2F0V.3010.000.. 110		45-2T07.4FJ0.000...	20	45-320.2E46.....	137	45-506.3A00.....	127	45-561.140P.....	118
45-2F13.1010.000. 109		45-2T07.4FK0.000...	20	45-320.2E47.....	137	45-507.1100.....	142	45-562.1400.....	118
45-2F13.2010.000. 109		45-311.1Z10.....	132	45-320.2E48.....	137	45-509.1100.....	142	45-563.0K00.....	115
45-2F13.3010.000. 109		45-311.1Z40.....	132	45-320.2F11.....	136	45-50C.1900.....	143	45-564.1102.....	119
45-2F14.1010.000. 109		45-311.2Z10.....	133	45-320.2F12.....	136	45-50C.2900.....	143	45-564.1110.....	120
45-2F14.2010.000. 109		45-311.2Z40.....	133	45-320.2F16.....	136	45-50D.1900.....	143	45-567.1103.....	119
45-2F14.3010.000. 109		45-312.1Z10.....	132	45-320.2F17.....	136	45-50D.2900.....	143	45-567.1111.....	120
45-2F38.1010.000. 110		45-312.1Z40.....	132	45-320.2F18.....	137	45-50E.1900.....	143	45-569.1105.....	119
45-2F38.2010.000. 110		45-312.2Z10.....	133	45-320.2F41.....	137	45-50E.2900.....	143	45-569.1112.....	120
45-2F38.3010.000. 110		45-312.2Z40.....	133	45-320.2F42.....	137	45-50F.1100.....	123	45-570.1105.....	120
45-2F40.1010.000. 109		45-320.1E11.....	134	45-320.2F46.....	137	45-50G.0900.....	143	45-571.1105.....	121
45-2F40.2010.000. 109		45-320.1E12.....	134	45-320.2F47.....	137	45-50J.1400.....	117	45-572.1105.....	121
45-2F40.3010.000. 109		45-320.1E16.....	134	45-320.2F48.....	137	45-50J.140P.....	117	45-573.1102.....	116
45-2J31.15T0.000... 49		45-320.1E17.....	134	45-320.2G11.....	136	45-50J.140Q.....	117	45-573.1103.....	116
45-2J31.15V0.000... 50		45-320.1E18.....	135	45-320.2G12.....	136	45-50J.140S.....	117	45-573.1104.....	116
45-2J31.16T0.000... 49		45-320.1E41.....	135	45-320.2G16.....	136	45-50J.140T.....	117	45-573.1105.....	116
45-2J31.16V0.000... 49		45-320.1E42.....	135	45-320.2G17.....	136	45-50J.140V.....	117	45-573.1202.....	116
45-2J31.25T0.000... 50		45-320.1E46.....	135	45-320.2G18.....	137	45-50J.140W.....	117	45-573.1A02.....	116
45-2J31.25V0.000... 50		45-320.1E47.....	135	45-320.2G41.....	137	45-50J.140X.....	118	45-573.1A03.....	116
45-2J31.26T0.000... 50		45-320.1E48.....	135	45-320.2G42.....	137	45-50J.140Z.....	118	45-573.1A04.....	116
45-2J31.26V0.000... 50		45-320.1F11.....	134	45-320.2G46.....	137	45-50K.1407.....	117	45-573.1A05.....	116
45-2J31.35T0.000... 50		45-320.1F12.....	134	45-320.2G47.....	137	45-50K.1408.....	117		
45-2J31.36T0.000... 50		45-320.1F16.....	134	45-320.2G48.....	137	45-50M.1900.....	140		
45-2J31.36V0.000... 50		45-320.1F17.....	134	45-320.2H11.....	136	45-50N.1100.....	126		
45-2K31.15T0.000... 59		45-320.1F18.....	135	45-320.2H12.....	136	45-50P.0100.....	126		
45-2K31.15V0.000... 60		45-320.1F41.....	135	45-320.2H16.....	136	45-50Q.2100.....	126		
45-2K31.16T0.000... 59		45-320.1F42.....	135	45-320.2H17.....	136	45-522.0900.....	129		
45-2K31.16V0.000... 59		45-320.1F46.....	135	45-320.2H18.....	137	45-523.1900.....	140		
45-2K31.35T0.000... 60		45-320.1F47.....	135	45-320.2H41.....	137	45-529.2100.....	124		
45-2K31.35V0.000... 60		45-320.1F48.....	135	45-320.2H42.....	137	45-530.2100.....	128		
45-2K31.36T0.000... 60		45-320.1G11.....	134	45-320.2H46.....	137	45-531.2100.....	128		
45-2K31.36V0.000... 60		45-320.1G12.....	134	45-320.2H47.....	137	45-532.2100.....	128		
45-2N39.1010.000. 111		45-320.1G16.....	134	45-320.2H48.....	137	45-533.2100.....	128		
45-2N39.2010.000. 111		45-320.1G17.....	134	45-320.2J11.....	136	45-534.2100.....	128		
45-2N39.3010.000. 111		45-320.1G18.....	135	45-320.2J12.....	136	45-535.2100.....	128		
45-2N42.1010.000. 111		45-320.1G41.....	135	45-320.2J16.....	136	45-536.2100.....	128		
45-2N42.2010.000. 111		45-320.1G42.....	135	45-320.2J17.....	136	45-537.2100.....	128		
45-2N42.3010.000. 111		45-320.1G46.....	135	45-320.2J18.....	137	45-538.1100.....	118		
45-2P01.1E10.000. 107		45-320.1G47.....	135	45-320.2J41.....	137	45-539.2400.....	125		
45-2P01.2E10.000. 107		45-320.1G48.....	135	45-320.2J42.....	137	45-539.2800.....	125		
45-2P02.1E10.000. 107		45-320.1H11.....	134	45-320.2J46.....	137	45-542.1K00.....	123		
45-2P02.2E10.000. 107		45-320.1H12.....	134	45-320.2J47.....	137	45-543.1K00.....	123		
45-2P03.1E10.000. 107		45-320.1H16.....	134	45-320.2J48.....	137	45-544.1K00.....	123		
45-2P03.2E10.000. 107		45-320.1H17.....	134	45-320.2N11.....	136	45-545.1K00.....	123		
45-2P04.1E10.000. 107		45-320.1H18.....	135	45-320.2N12.....	136	45-546.1K00.....	123		
45-2P04.2E10.000. 107		45-320.1H41.....	135	45-320.2N16.....	136	45-547.1K00.....	123		

EAO Contact.

Your centre of excellence.

Headquarters

EAO Holding AG
Tannwaldstrasse 88
CH-4600 Olten
Telephone +41 62 286 91 11
info@eao.com

Manufacturing Companies

Switzerland
EAO AG
Tannwaldstrasse 88
CH-4600 Olten
Telephone +41 62 286 91 11
info@eao.com

EAO Systems AG
Tannwaldstrasse 88
CH-4600 Olten
Telephone +41 62 286 91 11
sales.esy@eao.com

China
EAO (Guangzhou) Ltd.
3/F, Block G4, South China
New Materials Innovation Park
31 Kefeng Road,
Guangzhou Science City,
CN-Guangzhou, PRC
Telephone +86 20 3229 0390
sales.ecn@eao.com

Germany
EAO Automotive GmbH & Co. KG
Richard-Wagner-Straße 3
DE-08209 Auerbach/Vogtland
Telephone +49 3744 8264 0
sales.esa@eao.com

North America
EAO Corporation
One Parrott Drive
Shelton
US-CT 06484
Telephone +1 203 951 4600
sales.us@eao.com

Sales Companies

China
EAO (Guangzhou) Ltd.
3/F, Block G4, South China
New Materials Innovation Park
31 Kefeng Road,
Guangzhou Science City,
CN-Guangzhou, PRC
Telephone +86 20 3229 0390
sales.ecn@eao.com

EAO (Shanghai) Office
Rm. 403, Block 5#,
CIFI Century Square, Lane 28,
NO. 21, Danba Road,
Putuo District
CN-Shanghai PRC
Telephone +86 21 6095 0717
sales.ecn@eao.com

France
EAO France SAS
5, rue Henri François
FR-77330 Ozoir-la-Ferrière
Telephone +33 1 64 43 37 37
sales.efr@eao.com

**Germany, Austria,
Poland, Czech Republic**
EAO GmbH
Langenberger Straße 570
DE-45277 Essen
Telephone +49 201 8587 0
sales.ede@eao.com

Hong Kong (Asia Pacific)
EAO (Far East) Ltd.
Unit A1, 1/F, Block A
Tin On Industrial Building
777 Cheung Sha Wan Road
Lai Chi Kok, Kln
HK-Hong Kong
Telephone +852 27 86 91 41
sales.ehk@eao.com

Italy
EAO Italia S.r.l.
Centro Direzionale Summit –
Palazzo D1
Via Brescia, 28
IT-20063 Cernusco sul Naviglio (MI)
Telephone +39 02 92 471934
sales.eit@eao.com

Japan
EAO Japan Co. Ltd.
Net 1 Mita Bldg. 3F
3-1-4 Mita Minato-ku
JP-Tokyo 108-0073
Telephone +81 3 5444 5411
sales.ejp@eao.com

Netherlands, Belgium
EAO Benelux B.V.
Kamerlingh Onnesweg 46
NL-3316 GL Dordrecht
Telephone +31 78 653 17 00
sales.enl@eao.com

North America
EAO Corporation
One Parrott Drive
Shelton
US-CT 06484
Telephone +1 203 951 4600
sales.us@eao.com

Sweden
EAO Svenska AB
Box 7032
SE-121 07 Stockholm-Globen
Telephone +46 8 683 86 60
sales.esw@eao.se

Switzerland
EAO Schweiz AG
Tannwaldstrasse 88
CH-4600 Olten
Telephone +41 62 286 95 00
sales.ech@eao.com

United Kingdom
EAO Ltd.
Highland House
Albert Drive
Burgess Hill
GB-West Sussex RH15 9TN
Telephone +44 1444 236 000
sales.euk@eao.com



Компания «ЭлектроПласт» предлагает заключение долгосрочных отношений при поставках импортных электронных компонентов на взаимовыгодных условиях!

Наши преимущества:

- Оперативные поставки широкого спектра электронных компонентов отечественного и импортного производства напрямую от производителей и с крупнейших мировых складов;
- Поставка более 17-ти миллионов наименований электронных компонентов;
- Поставка сложных, дефицитных, либо снятых с производства позиций;
- Оперативные сроки поставки под заказ (от 5 рабочих дней);
- Экспресс доставка в любую точку России;
- Техническая поддержка проекта, помощь в подборе аналогов, поставка прототипов;
- Система менеджмента качества сертифицирована по Международному стандарту ISO 9001;
- Лицензия ФСБ на осуществление работ с использованием сведений, составляющих государственную тайну;
- Поставка специализированных компонентов (Xilinx, Altera, Analog Devices, Intersil, Interpoint, Microsemi, Aeroflex, Peregrine, Syfer, Eurofarad, Texas Instrument, Miteq, Cobham, E2V, MA-COM, Hittite, Mini-Circuits, General Dynamics и др.);

Помимо этого, одним из направлений компании «ЭлектроПласт» является направление «Источники питания». Мы предлагаем Вам помощь Конструкторского отдела:

- Подбор оптимального решения, техническое обоснование при выборе компонента;
- Подбор аналогов;
- Консультации по применению компонента;
- Поставка образцов и прототипов;
- Техническая поддержка проекта;
- Защита от снятия компонента с производства.



Как с нами связаться

Телефон: 8 (812) 309 58 32 (многоканальный)

Факс: 8 (812) 320-02-42

Электронная почта: org@eplast1.ru

Адрес: 198099, г. Санкт-Петербург, ул. Калинина, дом 2, корпус 4, литера А.