

# BWA SERIES RF CO-AXIAL CONNECTORS

The BWA series are converter adapters used for connecting connectors of different series.

- (1) Has mating portions compatible in materials and finish with the respective series.
- (2) Conforms in performance to the lower series of the two connectors to be connected.

## Converter adapter list

Mating portion 1		Mating portion 2		Part No.	CL No.	Remarks	Shape
Series name	Mating portion	Series name	Mating portion				
N	P	BNC	P	NP-BNCP(40)	311-0050-7-40		Fig.1
			J	JUG-201A/U(40)	311-0007-8-40		Fig.2
		M	J	NP-MJ(40)	311-0019-7-40		Fig.3
		S	J	N.P-S.J(40)	311-0245-6-40		Fig.4
		HRM	P	HRM-555S(40)	311-0125-4-40		Fig.5
			J	HRM-554S(40)	311-0123-9-40		Fig.6
	J	BNC	P	UG-349/U(40)	311-0004-0-40		Fig.7
			J	NJ-BNCJ(40)	311-0005-2-40		Fig.8
				NJ-BNCJ-PA(40)	311-0014-3-40	Panel-mount type	Fig.9
		M	P	NJ-MP(40)	311-0018-4-40		Fig.10
			J	NJ-MJ(40)	311-0011-5-40		Fig.11
		TNC	P	N.J-TNC.P(40)	311-0225-9-40		Fig.12
		HRM	P	HRM-553S	311-0121-3		Fig.13
			J	HRM-552S	311-0119-1		Fig.15
		BNC	P	M	P	BNCP-MP(40)	311-0062-6-40
J	BNCP-MJ(40)				311-0008-0-40		Fig.18
S	P			SP-BNCP(40)	311-0055-0-40		Fig.19
	J			SJ-BNCP(40)	311-0060-0-40		Fig.20
UM	J			BNCP-UMJ(40)	311-0065-4-40		Fig.21
MSS	P			BNCP-MSSP(40)	311-0107-2-40		Fig.22
	J			BNCP-MSSJ(40)	311-0082-3-40		Fig.23
HRM	P			HRM-519(40)	311-0101-6-40		Fig.24
	J			HRM-518(40)	311-0100-3-40		Fig.25
J	UHF			P	UG-273/U(40)	311-0003-7-40	
	M		P	BNCJ-MP(40)	311-0009-3-40		Fig.27
			J	MJ-BNCJ(40)	311-0020-6-40		Fig.28
	S		P	SP-BNCJ(40)	311-0058-9-40		Fig.29
			J	SJ-BNCJ(40)	311-0054-8-40		Fig.30
	SJ-BNCJ-PA(40)			311-0108-5-40	Panel-mount type	Fig.31	
	TNC		J	BNC.J-TNC.J(40)	311-0194-7-40		Fig.32
	UM		P	BNCJ-UMP(40)	311-0052-2-40		Fig.33
			J	BNCJ-UMJ(40)	311-0053-5-40		Fig.34
	BNCJ-UMJ-PA(40)			311-0103-1-40	Panel-mount type	Fig.35	
	MSS		P	BNCJ-MSSP(40)	311-0081-0-40		Fig.36
J			BNCJ-MSSJ(40)	311-0066-7-40		Fig.37	

# BWA SERIES RF CO-AXIAL CONNECTORS

Mating portion 1		Mating portion 2		Part No.	CL No.	Remarks	Shape
Series name	Mating portion	Series name	Mating portion				
BNC	J	HRM	P	HRM-517(40)	311-0099-6-40		Fig.38
			J	HRM-516(40)	311-0102-9-40		Fig.39
		POD	P	BNCJ-PODP(40)	311-0160-5-40		Fig.40
			J	BNCJ-PODJ(40)	311-0161-8-40		Fig.41
		PO6	J	BNCJ-PO6J(40)	311-0167-4-40		Fig.42
S	P	HRM	P	HRM-509(40)	311-0093-0-40		Fig.43
			J	HRM-508(40)	311-0092-7-40		Fig.44
	J	HRM	P	HRM-507(40)	311-0091-4-40		Fig.45
				HRM-512(40)	311-0098-3-40	Panel-mount type	Fig.46
			HRM-512S(40)	311-0144-9-40	Panel-mount type, S type	Fig.46	
			HRM-506(40)	311-0090-1-40		Fig.47	
			J	HRM-511(40)	311-0094-2-40	Panel-mount type	Fig.48
				HRM-511S(40)	311-0143-6-40	Panel-mount type, S type	Fig.48
TNC	J	HRM	J	HRMJ-TNCJ-PA(40)	311-0202-3-40	Panel-mount type	Fig.49
UM	P	HRM	J	UM.P-HRM.J(40)	311-0176-5-40		Fig.50
	J	HRM	J	HRMJ-UMJ(40)	311-0164-6-40		Fig.51
HRM	P	POB	P	HRMP-POBP-1(40)	311-0169-0-40		Fig.52
			J	HRMP-POBJ	311-0152-7		Fig.53
		POD	J	HRM.P-POD.J(40)	311-0177-8-40		Fig.54
		POD1	J	HRMP-POD1J(40)	311-0253-4-40		Fig.55
		PO6	J	HRMP-PO6J(40)	311-0172-4-40		Fig.56
		S,FL	J	HRMP-S.FLJ-2(40)	311-0249-7-40	For inspecting harnesses parts	Fig.57
		H,FL	J	HRMP-H.FLJ(40)	311-0232-4-40	For inspecting harnesses parts	Fig.58
		HRMM	P	HRMP-HRMMJ(40)	311-0250-6-40		Fig.59
				J	HRMP-HRMMJ	311-0243-0	
			HRMP-HRMMJ-LA(40)	311-0226-1-40		Fig.61	
		J	POB	P	HRMJ-POBP(40)	311-0151-4-40	
	HRMJ-POBP-PA(40)				311-0206-4-40		Fig.63
	J			HRMJ-POBJ(40)	311-0149-2-40		Fig.64
				HRMJ-POBJ-PA(40)	311-0150-1-40		Fig.65
	POD		P	HRMJ-PODP(40)	311-0157-0-40		Fig.66
	POD1		P	HRMJ-POD1P-1(40)	311-0254-7-40		Fig.67
	PO6		P	HRMJ-PO6P(40)	311-0173-7-40		Fig.68
	PO51		P	HRMJ-PO51P(40)	311-0231-1-40		Fig.69
	FL		P	HRMJ-FLP-1(40)	311-0195-0-40		Fig.70
			J	HRMJ-FLJ(40)	311-0179-3-40		Fig.71
	S,FL		P	HRMJ-S.FLP(40)	311-0218-3-40		Fig.72
	H,FL		P	HRMJ-H.FLP-3(40)	311-0264-0-40		Fig.73
	HRMM	P	HRMJ-HRMMJ-2	311-0221-8		Fig.74	
HRMJ-HRMMJ-LA(40)			311-0227-4-40		Fig.75		
J		HRMJ-HRMMJ	311-0220-5		Fig.76		

- Note 1. Part No. NP-BNCP of Fig.1 is shown that series name N, coupling part p (plug) for connecting part 1 and series name BNC, coupling part P (plug) for connecting part 2.
2. Series name of each connecting parts are shown in order to HIROSE's CL numbers.

# BWA SERIES RF CO-AXIAL CONNECTORS

<p>Fig.1</p> <p>NP-BNCP(40)</p>	<p>Fig.2</p> <p>UG-201A/U(40)</p>
<p>Fig.3</p> <p>NP-MJ(40)</p>	<p>Fig.4</p> <p>N.P-S.J(40)</p>
<p>Fig.5</p> <p>HRM-555S(40)</p>	<p>Fig.6</p> <p>HRM-554S(40)</p>
<p>Fig.7</p> <p>UG-349/U(40)</p>	<p>Fig.8</p> <p>NJ-BNCJ(40)</p>

# BWA SERIES RF CO-AXIAL CONNECTORS

Fig.9

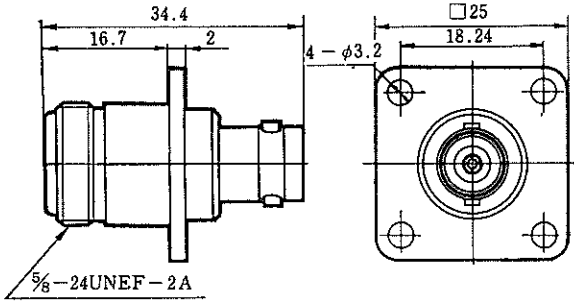

NJ-BNCJ-PA(40)

Fig.10

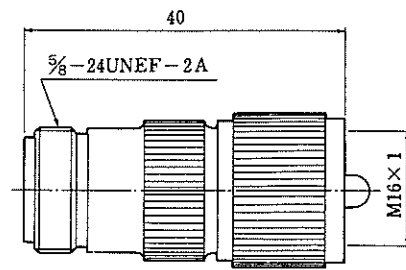

NJ-MP(40)

Fig.11

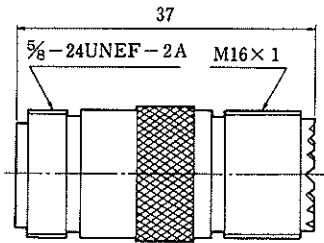

NJ-MJ(40)

Fig.12

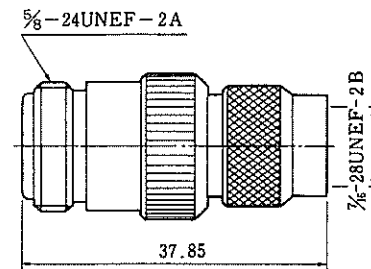

NJ-TNC.P(40)

Fig.13

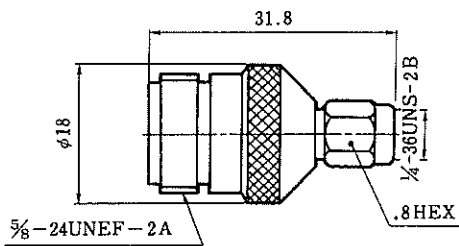

HRM-553S

Fig.15

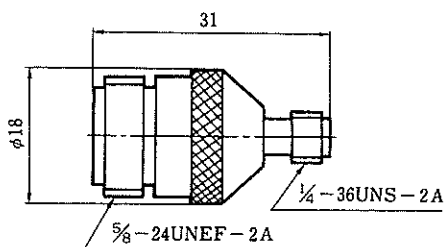

HRM-552S

# BWA SERIES RF CO-AXIAL CONNECTORS

Fig.17

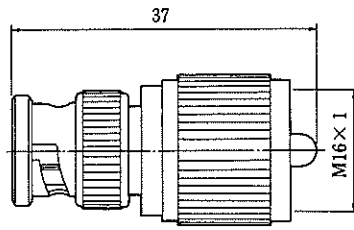

BNCMP-MP(40)

Fig.18

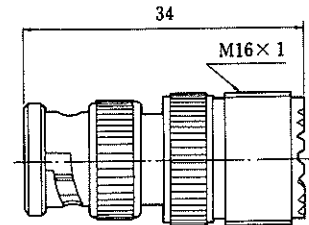

BNCMP-MJ(40)

Fig.19

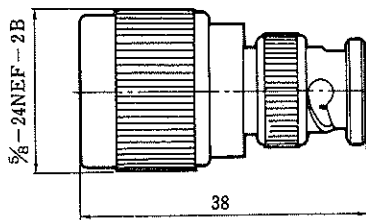

SP-BNCP(40)

Fig.20

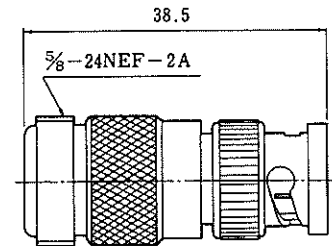

SJ-BNCP(40)

Fig.21

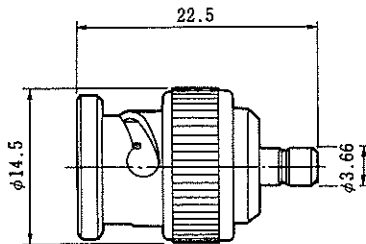

BNCMP-UMJ(40)

Fig.22

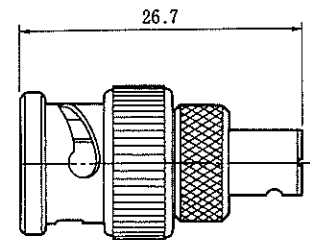

BNCMP-MSSP(40)

Fig.23

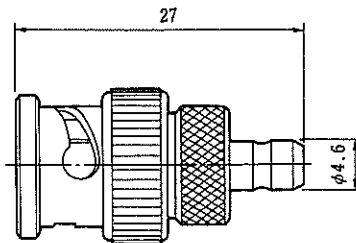

BNCMP-MSSJ(40)

Fig.24

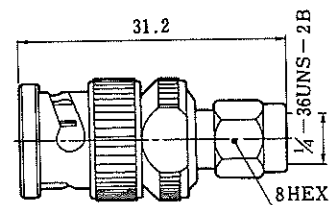

HRM-519(40)

# BWA SERIES RF CO-AXIAL CONNECTORS

Fig.25

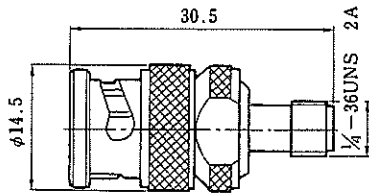

HRM-518(40)

Fig.26

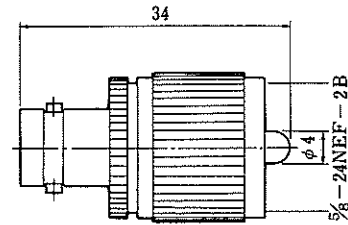

UG-273/U(40)

Fig.27

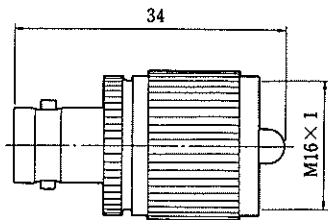

BNCJ-MP(40)

Fig.28

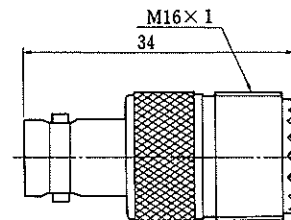

MJ-BNCJ(40)

Fig.29

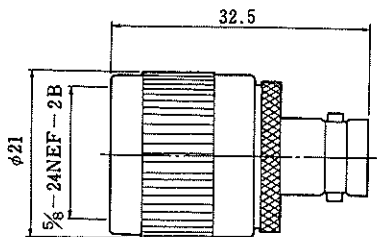

SP-BNCJ(40)

Fig.30

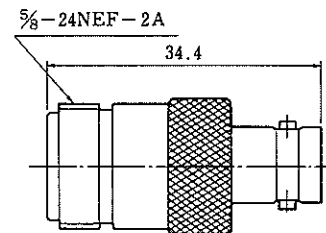

SJ-BNCJ(40)

Fig.31

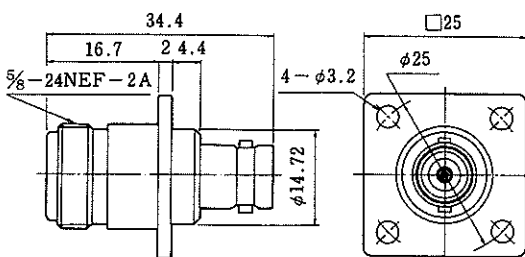

SJ-BNCJ-PA(40)

Fig.32

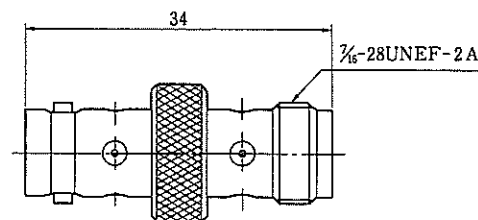

BNCJ-TNCJ(40)

# BWA SERIES RF CO-AXIAL CONNECTORS

Fig.33

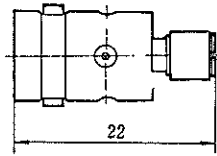

BNCJ-UMP(40)

Fig.34

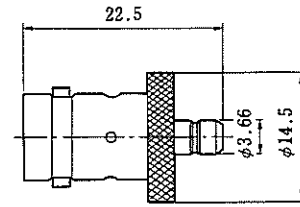

BNCJ-UMJ(40)

Fig.35

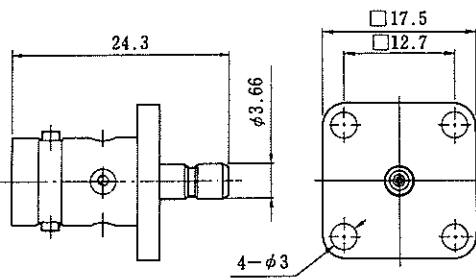

BNCJ-UMJ-PA(40)

Fig.36

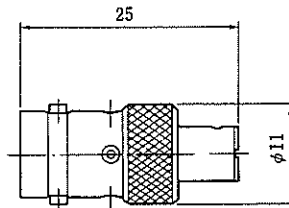

BNCJ-MSSP(40)

Fig.37

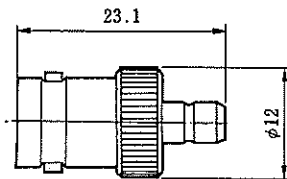

BNCJ-MSSJ(40)

Fig.38

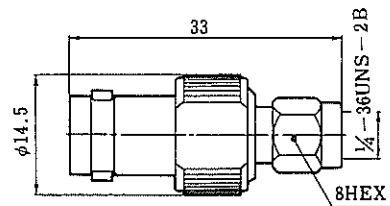

HRM-517(40)

Fig.39

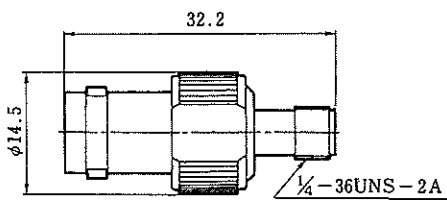

HRM-516(40)

Fig.40

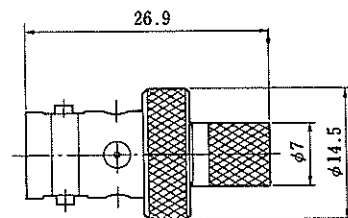

BNCJ-PODP(40)

# BWA SERIES RF CO-AXIAL CONNECTORS

Fig.41

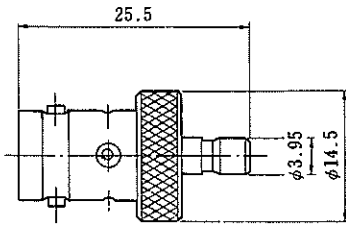

BNCJ-PODJ(40)

Fig.42

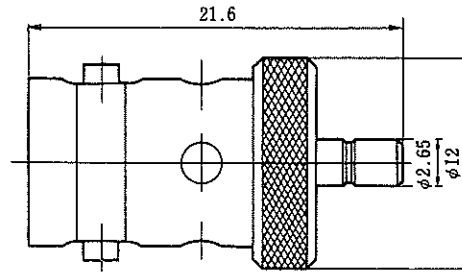

BNCJ-PO6J(40)

Fig.43

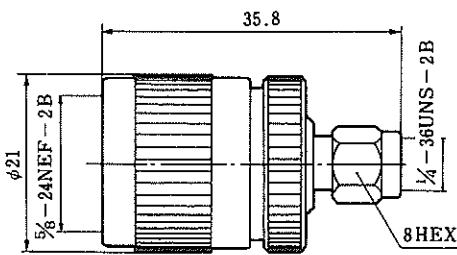

HRM-509(40)

Fig.44

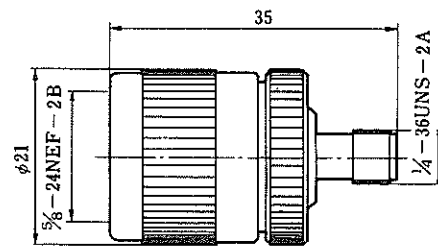

HRM-508(40)

Fig.45

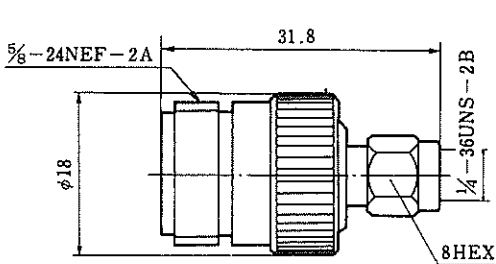

HRM-507(40)

Fig.46

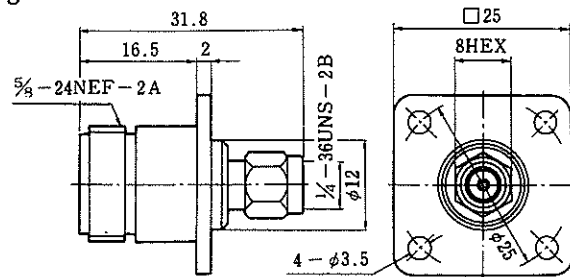

HRM-512(40) HRM-512S(40)

Fig.47

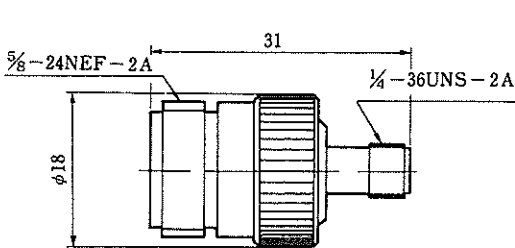

HRM-506(40)

Fig.48

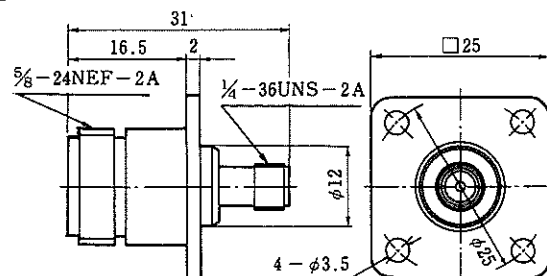

HRM-511(40) HRM-511S(40)



# BWA SERIES RF CO-AXIAL CONNECTORS

Fig.49

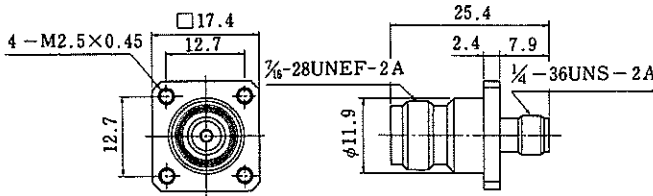

HRMJ-TNCJ-PA(40)

Fig.50

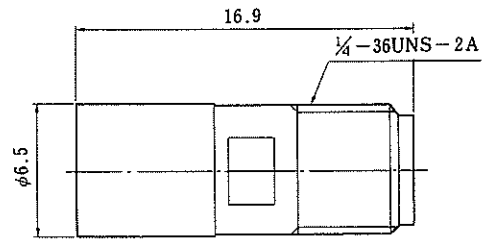

UM.P-HRMJ(40)

Fig.51

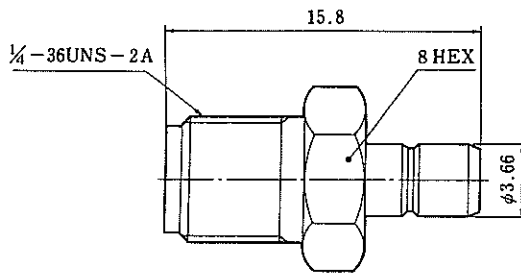

HRMJ-UMJ(40)

Fig.52

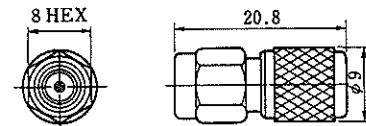

HRMP-POBP-1(40)

Fig.53

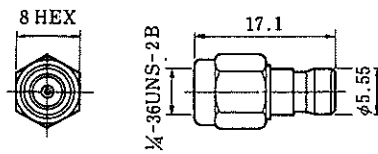

HRMP-POBJ

Fig.54

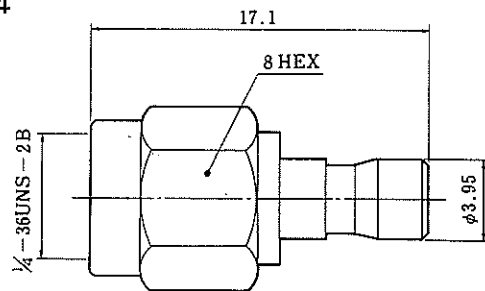

HRM.P-POD.J(40)

Fig.55

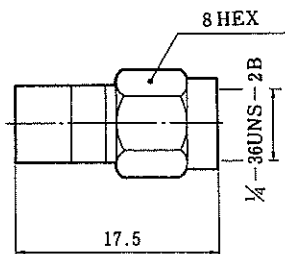

HRMP-POD1J(40)

Fig.56

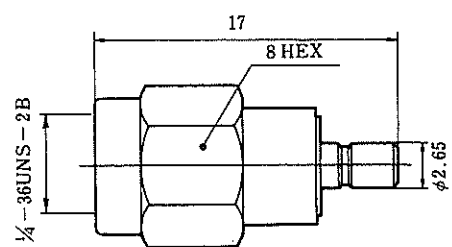

HRMP-PO6J(40)

# BWA SERIES RF CO-AXIAL CONNECTORS

Fig.57

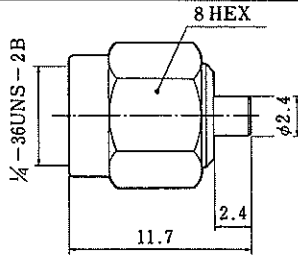

Note : The mating portion on the S. FL side mates with the S. FL and S. FL2 plugs.  
 Having no locking mechanism, however, the S. FL side mating portion can be used only for performance measurement.

HRMP-S.FLJ-2(40)

Fig.58

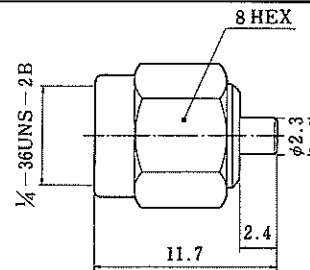

Note : Having no locking mechanism, however, the S. FL side mating portion can be used only for performance measurement.

HRMP-H.FLJ(40)

Fig.59

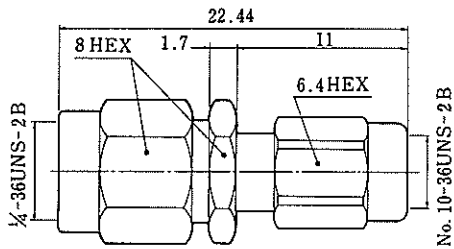

HRMP-HRMP(40)

Fig.60

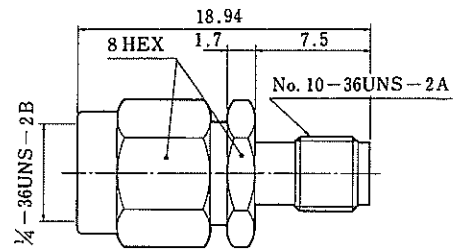

HRMP-HRMM(40)

Fig.61

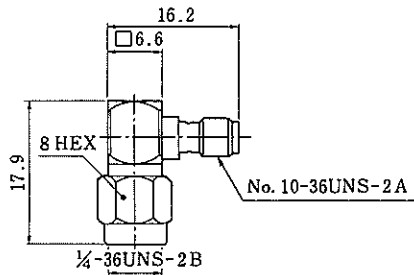

HRMP-HRMMJ-LA(40)

Fig.62

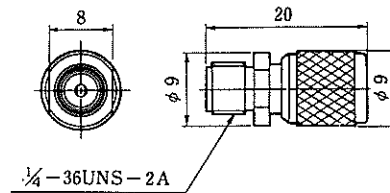

HRMJ-POBP(40)

Fig.63

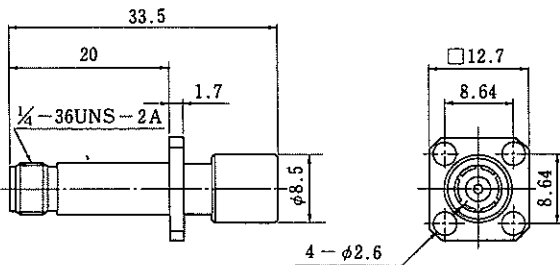

HRMJ-POBP-PA(40)

Fig.64

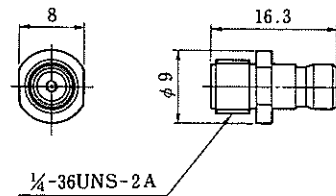

HRMJ-POBJ(40)

# BWA SERIES RF CO-AXIAL CONNECTORS

Fig.65

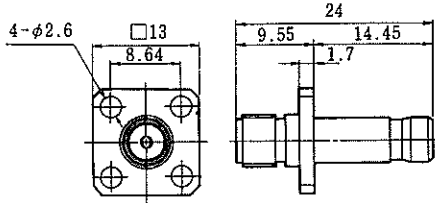

HRMJ-POBJ-PA(40)

Fig.66

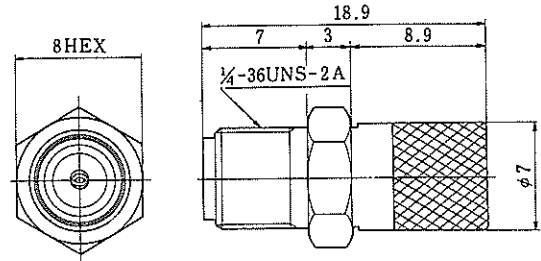

HRMJ-PODP(40)

Fig.67

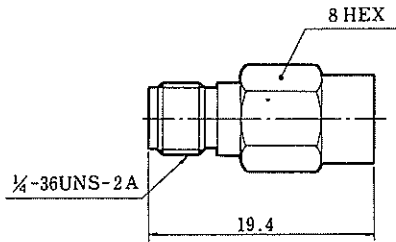

HRMJ-POD1P-1(40)

Fig.68

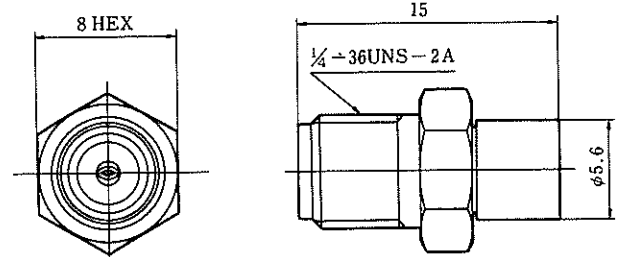

HRMJ-PO6P(40)

Fig.69

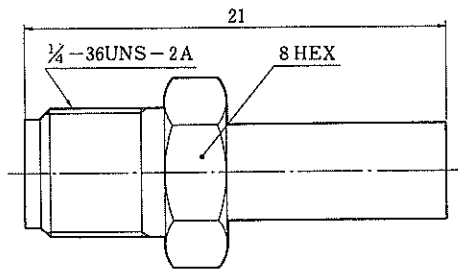

HRMJ-PO51P(40)

Fig.70

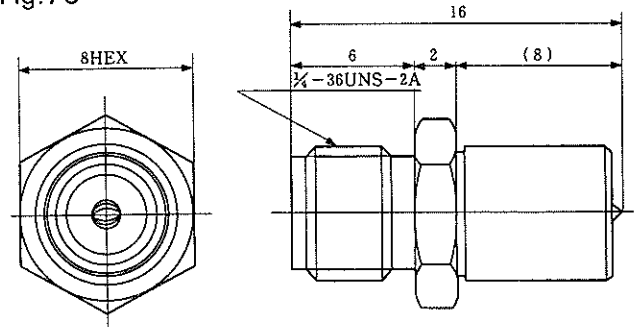

HRMJ-FLP-1(40)

Fig.71

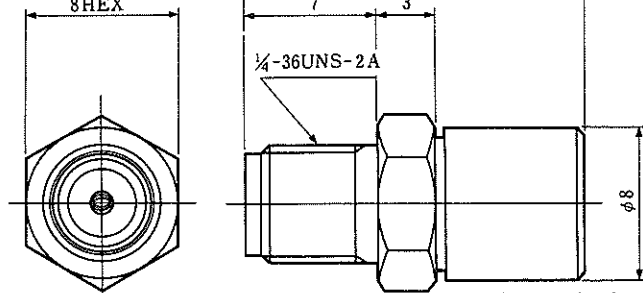

HRMJ-FLJ(40)

Note: Having no locking mechanism, however, the FL side mating portion can be used only for performance measurement.

Fig.72

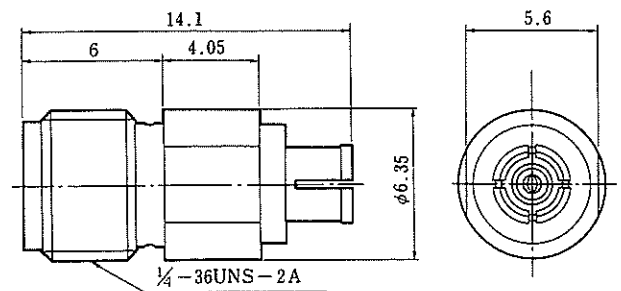

HRMJ-S.FLP(40)

Note: Compatible with S. FL and S. FL2.

# BWA SERIES RF CO-AXIAL CONNECTORS

Fig. 73

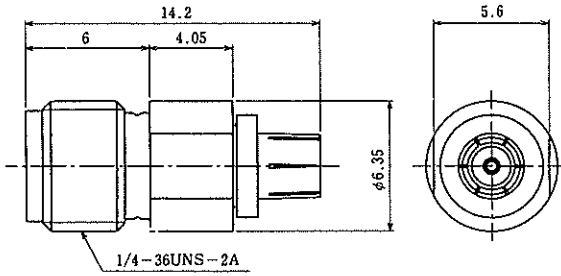

HRMJ-H.FLP-3(40)

Fig. 74

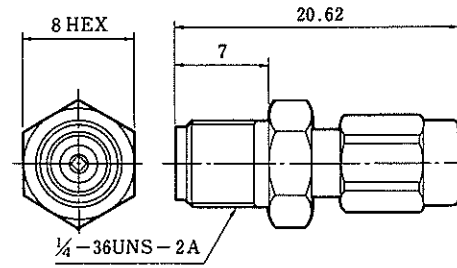

HRMJ-HRMMP-2

Fig. 75

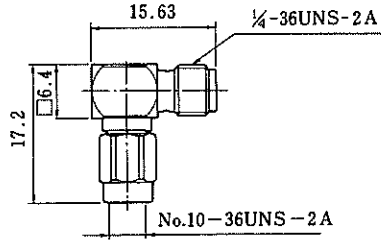

HRMJ-HRMMP-LA(40)

Fig. 76

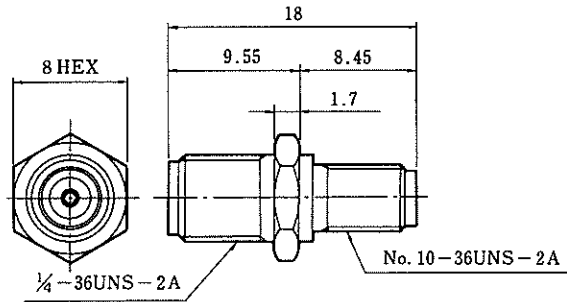

HRMJ-HRMMJ



Компания «ЭлектроПласт» предлагает заключение долгосрочных отношений при поставках импортных электронных компонентов на взаимовыгодных условиях!

Наши преимущества:

- Оперативные поставки широкого спектра электронных компонентов отечественного и импортного производства напрямую от производителей и с крупнейших мировых складов;
- Поставка более 17-ти миллионов наименований электронных компонентов;
- Поставка сложных, дефицитных, либо снятых с производства позиций;
- Оперативные сроки поставки под заказ (от 5 рабочих дней);
- Экспресс доставка в любую точку России;
- Техническая поддержка проекта, помощь в подборе аналогов, поставка прототипов;
- Система менеджмента качества сертифицирована по Международному стандарту ISO 9001;
- Лицензия ФСБ на осуществление работ с использованием сведений, составляющих государственную тайну;
- Поставка специализированных компонентов (Xilinx, Altera, Analog Devices, Intersil, Interpoint, Microsemi, Aeroflex, Peregrine, Syfer, Eurofarad, Texas Instrument, Miteq, Cobham, E2V, MA-COM, Hittite, Mini-Circuits, General Dynamics и др.);

Помимо этого, одним из направлений компании «ЭлектроПласт» является направление «Источники питания». Мы предлагаем Вам помощь Конструкторского отдела:

- Подбор оптимального решения, техническое обоснование при выборе компонента;
- Подбор аналогов;
- Консультации по применению компонента;
- Поставка образцов и прототипов;
- Техническая поддержка проекта;
- Защита от снятия компонента с производства.



#### Как с нами связаться

**Телефон:** 8 (812) 309 58 32 (многоканальный)

**Факс:** 8 (812) 320-02-42

**Электронная почта:** [org@eplast1.ru](mailto:org@eplast1.ru)

**Адрес:** 198099, г. Санкт-Петербург, ул. Калинина, дом 2, корпус 4, литера А.