

# Type 500C 95 °C Long Life, Screw Terminal, Aluminum

## Long Life, High Capacitance Screw Terminal Type



Type 500C capacitors are designed for mainframe computers and other long life UPS and power supply filter applications. They deliver nearly as much capacitance as the Type DCMC capacitors, but with two times the life expectancy. They are an excellent choice for high ripple applications. The extended cathode foil of the 500C assures cool operation with heat flow from the capacitor element to the can.

### Highlights

- Long-life, High-Capacitance
- Better for Power-supply and UPS systems
- Thermal-Pak™ extended cathode construction

### Specifications

| Temperature Range                | -40 °C to +95 °C  |       |        |        |       |       |             |  |      |      |      |      |      |           |       |       |        |        |       |       |             |                                      |  |  |  |  |  |  |  |                     |      |      |      |      |      |      |      |                     |      |      |      |      |      |      |      |                      |      |      |      |      |      |      |      |                                  |  |  |  |  |  |  |  |                     |      |      |      |      |      |      |      |                     |      |      |      |      |      |      |      |                     |      |      |      |      |      |      |      |                                  |  |  |  |  |  |  |  |                     |      |      |      |      |      |      |      |                     |      |      |      |      |      |      |      |                     |      |      |      |      |      |      |      |
|----------------------------------|---|-------|--------|--------|-------|-------|-------------|--|------|------|------|------|------|-----------|-------|-------|--------|--------|-------|-------|-------------|--------------------------------------|--|--|--|--|--|--|--|---------------------|------|------|------|------|------|------|------|---------------------|------|------|------|------|------|------|------|----------------------|------|------|------|------|------|------|------|----------------------------------|--|--|--|--|--|--|--|---------------------|------|------|------|------|------|------|------|---------------------|------|------|------|------|------|------|------|---------------------|------|------|------|------|------|------|------|----------------------------------|--|--|--|--|--|--|--|---------------------|------|------|------|------|------|------|------|---------------------|------|------|------|------|------|------|------|---------------------|------|------|------|------|------|------|------|
| Rated Voltage Range              | 6.3 Vdc to 500 Vdc  |       |        |        |       |       |             |  |      |      |      |      |      |           |       |       |        |        |       |       |             |                                      |  |  |  |  |  |  |  |                     |      |      |      |      |      |      |      |                     |      |      |      |      |      |      |      |                      |      |      |      |      |      |      |      |                                  |  |  |  |  |  |  |  |                     |      |      |      |      |      |      |      |                     |      |      |      |      |      |      |      |                     |      |      |      |      |      |      |      |                                  |  |  |  |  |  |  |  |                     |      |      |      |      |      |      |      |                     |      |      |      |      |      |      |      |                     |      |      |      |      |      |      |      |
| Capacitance Range                | 100 µF to 2.6 F   |       |        |        |       |       |             |  |      |      |      |      |      |           |       |       |        |        |       |       |             |                                      |  |  |  |  |  |  |  |                     |      |      |      |      |      |      |      |                     |      |      |      |      |      |      |      |                      |      |      |      |      |      |      |      |                                  |  |  |  |  |  |  |  |                     |      |      |      |      |      |      |      |                     |      |      |      |      |      |      |      |                     |      |      |      |      |      |      |      |                                  |  |  |  |  |  |  |  |                     |      |      |      |      |      |      |      |                     |      |      |      |      |      |      |      |                     |      |      |      |      |      |      |      |
| Capacitance Tolerance            | -10% +75% ≤ 160 Vdc<br>-10% +50% ≥ 200 Vdc  |       |        |        |       |       |             |  |      |      |      |      |      |           |       |       |        |        |       |       |             |                                      |  |  |  |  |  |  |  |                     |      |      |      |      |      |      |      |                     |      |      |      |      |      |      |      |                      |      |      |      |      |      |      |      |                                  |  |  |  |  |  |  |  |                     |      |      |      |      |      |      |      |                     |      |      |      |      |      |      |      |                     |      |      |      |      |      |      |      |                                  |  |  |  |  |  |  |  |                     |      |      |      |      |      |      |      |                     |      |      |      |      |      |      |      |                     |      |      |      |      |      |      |      |
| Leakage Current                  | ≤ 3 √CV µA, 4 mA max, 5 minutes   |       |        |        |       |       |             |  |      |      |      |      |      |           |       |       |        |        |       |       |             |                                      |  |  |  |  |  |  |  |                     |      |      |      |      |      |      |      |                     |      |      |      |      |      |      |      |                      |      |      |      |      |      |      |      |                                  |  |  |  |  |  |  |  |                     |      |      |      |      |      |      |      |                     |      |      |      |      |      |      |      |                     |      |      |      |      |      |      |      |                                  |  |  |  |  |  |  |  |                     |      |      |      |      |      |      |      |                     |      |      |      |      |      |      |      |                     |      |      |      |      |      |      |      |
| Ripple Current Multipliers       | <p>Ambient Temperature</p> <table border="1"> <thead> <tr> <th></th> <th>45 °C</th> <th>55 °C</th> <th>65 °C</th> <th>75 °C</th> <th>85 °C</th> </tr> </thead> <tbody> <tr> <td></td> <td>2.00</td> <td>1.82</td> <td>1.59</td> <td>1.33</td> <td>1.00</td> </tr> </tbody> </table><br><table border="1"> <thead> <tr> <th rowspan="2">Frequency</th> <th>50 Hz</th> <th>60 Hz</th> <th>120 Hz</th> <th>360 Hz</th> <th>1 kHz</th> <th>5 kHz</th> <th>10 kHz &amp; up</th> </tr> </thead> <tbody> <tr> <td><b>1 3/8" &amp; 1 3/4" Diameters</b></td> <td></td> <td></td> <td></td> <td></td> <td></td> <td></td> <td></td> </tr> <tr> <td><b>6.3 to 160 V</b></td> <td>0.91</td> <td>0.93</td> <td>1.00</td> <td>1.06</td> <td>1.08</td> <td>1.10</td> <td>1.10</td> </tr> <tr> <td><b>200 to 350 V</b></td> <td>0.76</td> <td>0.81</td> <td>1.00</td> <td>1.24</td> <td>1.36</td> <td>1.43</td> <td>1.44</td> </tr> <tr> <td><b>400 to 500 Vx</b></td> <td>0.76</td> <td>0.81</td> <td>1.00</td> <td>1.24</td> <td>1.37</td> <td>1.44</td> <td>1.45</td> </tr> <tr> <td><b>2" &amp; 2 1/2" Diameters</b></td> <td></td> <td></td> <td></td> <td></td> <td></td> <td></td> <td></td> </tr> <tr> <td><b>6.3 to 160 V</b></td> <td>0.93</td> <td>0.95</td> <td>1.00</td> <td>1.04</td> <td>1.06</td> <td>1.06</td> <td>1.07</td> </tr> <tr> <td><b>200 to 350 V</b></td> <td>0.78</td> <td>0.83</td> <td>1.00</td> <td>1.20</td> <td>1.29</td> <td>1.34</td> <td>1.35</td> </tr> <tr> <td><b>400 to 500 V</b></td> <td>0.77</td> <td>0.82</td> <td>1.00</td> <td>1.22</td> <td>1.33</td> <td>1.39</td> <td>1.40</td> </tr> <tr> <td><b>3" &amp; 3 1/2" Diameters</b></td> <td></td> <td></td> <td></td> <td></td> <td></td> <td></td> <td></td> </tr> <tr> <td><b>6.3 to 160 V</b></td> <td>0.95</td> <td>0.97</td> <td>1.00</td> <td>1.03</td> <td>1.04</td> <td>1.04</td> <td>1.04</td> </tr> <tr> <td><b>200 to 350 V</b></td> <td>0.84</td> <td>0.88</td> <td>1.00</td> <td>1.12</td> <td>1.17</td> <td>1.20</td> <td>1.20</td> </tr> <tr> <td><b>400 to 500 V</b></td> <td>0.79</td> <td>0.84</td> <td>1.00</td> <td>1.18</td> <td>1.26</td> <td>1.31</td> <td>1.32</td> </tr> </tbody> </table> |       | 45 °C  | 55 °C  | 65 °C | 75 °C | 85 °C       |  | 2.00 | 1.82 | 1.59 | 1.33 | 1.00 | Frequency | 50 Hz | 60 Hz | 120 Hz | 360 Hz | 1 kHz | 5 kHz | 10 kHz & up | <b>1 3/8" &amp; 1 3/4" Diameters</b> |  |  |  |  |  |  |  | <b>6.3 to 160 V</b> | 0.91 | 0.93 | 1.00 | 1.06 | 1.08 | 1.10 | 1.10 | <b>200 to 350 V</b> | 0.76 | 0.81 | 1.00 | 1.24 | 1.36 | 1.43 | 1.44 | <b>400 to 500 Vx</b> | 0.76 | 0.81 | 1.00 | 1.24 | 1.37 | 1.44 | 1.45 | <b>2" &amp; 2 1/2" Diameters</b> |  |  |  |  |  |  |  | <b>6.3 to 160 V</b> | 0.93 | 0.95 | 1.00 | 1.04 | 1.06 | 1.06 | 1.07 | <b>200 to 350 V</b> | 0.78 | 0.83 | 1.00 | 1.20 | 1.29 | 1.34 | 1.35 | <b>400 to 500 V</b> | 0.77 | 0.82 | 1.00 | 1.22 | 1.33 | 1.39 | 1.40 | <b>3" &amp; 3 1/2" Diameters</b> |  |  |  |  |  |  |  | <b>6.3 to 160 V</b> | 0.95 | 0.97 | 1.00 | 1.03 | 1.04 | 1.04 | 1.04 | <b>200 to 350 V</b> | 0.84 | 0.88 | 1.00 | 1.12 | 1.17 | 1.20 | 1.20 | <b>400 to 500 V</b> | 0.79 | 0.84 | 1.00 | 1.18 | 1.26 | 1.31 | 1.32 |
|                                  | 45 °C   | 55 °C | 65 °C  | 75 °C  | 85 °C |       |             |  |      |      |      |      |      |           |       |       |        |        |       |       |             |                                      |  |  |  |  |  |  |  |                     |      |      |      |      |      |      |      |                     |      |      |      |      |      |      |      |                      |      |      |      |      |      |      |      |                                  |  |  |  |  |  |  |  |                     |      |      |      |      |      |      |      |                     |      |      |      |      |      |      |      |                     |      |      |      |      |      |      |      |                                  |  |  |  |  |  |  |  |                     |      |      |      |      |      |      |      |                     |      |      |      |      |      |      |      |                     |      |      |      |      |      |      |      |
|                                  | 2.00  | 1.82  | 1.59   | 1.33   | 1.00  |       |             |  |      |      |      |      |      |           |       |       |        |        |       |       |             |                                      |  |  |  |  |  |  |  |                     |      |      |      |      |      |      |      |                     |      |      |      |      |      |      |      |                      |      |      |      |      |      |      |      |                                  |  |  |  |  |  |  |  |                     |      |      |      |      |      |      |      |                     |      |      |      |      |      |      |      |                     |      |      |      |      |      |      |      |                                  |  |  |  |  |  |  |  |                     |      |      |      |      |      |      |      |                     |      |      |      |      |      |      |      |                     |      |      |      |      |      |      |      |
| Frequency                        | 50 Hz   | 60 Hz | 120 Hz | 360 Hz | 1 kHz | 5 kHz | 10 kHz & up |  |      |      |      |      |      |           |       |       |        |        |       |       |             |                                      |  |  |  |  |  |  |  |                     |      |      |      |      |      |      |      |                     |      |      |      |      |      |      |      |                      |      |      |      |      |      |      |      |                                  |  |  |  |  |  |  |  |                     |      |      |      |      |      |      |      |                     |      |      |      |      |      |      |      |                     |      |      |      |      |      |      |      |                                  |  |  |  |  |  |  |  |                     |      |      |      |      |      |      |      |                     |      |      |      |      |      |      |      |                     |      |      |      |      |      |      |      |
|                                  | <b>1 3/8" &amp; 1 3/4" Diameters</b>  |       |        |        |       |       |             |  |      |      |      |      |      |           |       |       |        |        |       |       |             |                                      |  |  |  |  |  |  |  |                     |      |      |      |      |      |      |      |                     |      |      |      |      |      |      |      |                      |      |      |      |      |      |      |      |                                  |  |  |  |  |  |  |  |                     |      |      |      |      |      |      |      |                     |      |      |      |      |      |      |      |                     |      |      |      |      |      |      |      |                                  |  |  |  |  |  |  |  |                     |      |      |      |      |      |      |      |                     |      |      |      |      |      |      |      |                     |      |      |      |      |      |      |      |
| <b>6.3 to 160 V</b>              | 0.91  | 0.93  | 1.00   | 1.06   | 1.08  | 1.10  | 1.10        |  |      |      |      |      |      |           |       |       |        |        |       |       |             |                                      |  |  |  |  |  |  |  |                     |      |      |      |      |      |      |      |                     |      |      |      |      |      |      |      |                      |      |      |      |      |      |      |      |                                  |  |  |  |  |  |  |  |                     |      |      |      |      |      |      |      |                     |      |      |      |      |      |      |      |                     |      |      |      |      |      |      |      |                                  |  |  |  |  |  |  |  |                     |      |      |      |      |      |      |      |                     |      |      |      |      |      |      |      |                     |      |      |      |      |      |      |      |
| <b>200 to 350 V</b>              | 0.76  | 0.81  | 1.00   | 1.24   | 1.36  | 1.43  | 1.44        |  |      |      |      |      |      |           |       |       |        |        |       |       |             |                                      |  |  |  |  |  |  |  |                     |      |      |      |      |      |      |      |                     |      |      |      |      |      |      |      |                      |      |      |      |      |      |      |      |                                  |  |  |  |  |  |  |  |                     |      |      |      |      |      |      |      |                     |      |      |      |      |      |      |      |                     |      |      |      |      |      |      |      |                                  |  |  |  |  |  |  |  |                     |      |      |      |      |      |      |      |                     |      |      |      |      |      |      |      |                     |      |      |      |      |      |      |      |
| <b>400 to 500 Vx</b>             | 0.76  | 0.81  | 1.00   | 1.24   | 1.37  | 1.44  | 1.45        |  |      |      |      |      |      |           |       |       |        |        |       |       |             |                                      |  |  |  |  |  |  |  |                     |      |      |      |      |      |      |      |                     |      |      |      |      |      |      |      |                      |      |      |      |      |      |      |      |                                  |  |  |  |  |  |  |  |                     |      |      |      |      |      |      |      |                     |      |      |      |      |      |      |      |                     |      |      |      |      |      |      |      |                                  |  |  |  |  |  |  |  |                     |      |      |      |      |      |      |      |                     |      |      |      |      |      |      |      |                     |      |      |      |      |      |      |      |
| <b>2" &amp; 2 1/2" Diameters</b> |   |       |        |        |       |       |             |  |      |      |      |      |      |           |       |       |        |        |       |       |             |                                      |  |  |  |  |  |  |  |                     |      |      |      |      |      |      |      |                     |      |      |      |      |      |      |      |                      |      |      |      |      |      |      |      |                                  |  |  |  |  |  |  |  |                     |      |      |      |      |      |      |      |                     |      |      |      |      |      |      |      |                     |      |      |      |      |      |      |      |                                  |  |  |  |  |  |  |  |                     |      |      |      |      |      |      |      |                     |      |      |      |      |      |      |      |                     |      |      |      |      |      |      |      |
| <b>6.3 to 160 V</b>              | 0.93  | 0.95  | 1.00   | 1.04   | 1.06  | 1.06  | 1.07        |  |      |      |      |      |      |           |       |       |        |        |       |       |             |                                      |  |  |  |  |  |  |  |                     |      |      |      |      |      |      |      |                     |      |      |      |      |      |      |      |                      |      |      |      |      |      |      |      |                                  |  |  |  |  |  |  |  |                     |      |      |      |      |      |      |      |                     |      |      |      |      |      |      |      |                     |      |      |      |      |      |      |      |                                  |  |  |  |  |  |  |  |                     |      |      |      |      |      |      |      |                     |      |      |      |      |      |      |      |                     |      |      |      |      |      |      |      |
| <b>200 to 350 V</b>              | 0.78  | 0.83  | 1.00   | 1.20   | 1.29  | 1.34  | 1.35        |  |      |      |      |      |      |           |       |       |        |        |       |       |             |                                      |  |  |  |  |  |  |  |                     |      |      |      |      |      |      |      |                     |      |      |      |      |      |      |      |                      |      |      |      |      |      |      |      |                                  |  |  |  |  |  |  |  |                     |      |      |      |      |      |      |      |                     |      |      |      |      |      |      |      |                     |      |      |      |      |      |      |      |                                  |  |  |  |  |  |  |  |                     |      |      |      |      |      |      |      |                     |      |      |      |      |      |      |      |                     |      |      |      |      |      |      |      |
| <b>400 to 500 V</b>              | 0.77  | 0.82  | 1.00   | 1.22   | 1.33  | 1.39  | 1.40        |  |      |      |      |      |      |           |       |       |        |        |       |       |             |                                      |  |  |  |  |  |  |  |                     |      |      |      |      |      |      |      |                     |      |      |      |      |      |      |      |                      |      |      |      |      |      |      |      |                                  |  |  |  |  |  |  |  |                     |      |      |      |      |      |      |      |                     |      |      |      |      |      |      |      |                     |      |      |      |      |      |      |      |                                  |  |  |  |  |  |  |  |                     |      |      |      |      |      |      |      |                     |      |      |      |      |      |      |      |                     |      |      |      |      |      |      |      |
| <b>3" &amp; 3 1/2" Diameters</b> |   |       |        |        |       |       |             |  |      |      |      |      |      |           |       |       |        |        |       |       |             |                                      |  |  |  |  |  |  |  |                     |      |      |      |      |      |      |      |                     |      |      |      |      |      |      |      |                      |      |      |      |      |      |      |      |                                  |  |  |  |  |  |  |  |                     |      |      |      |      |      |      |      |                     |      |      |      |      |      |      |      |                     |      |      |      |      |      |      |      |                                  |  |  |  |  |  |  |  |                     |      |      |      |      |      |      |      |                     |      |      |      |      |      |      |      |                     |      |      |      |      |      |      |      |
| <b>6.3 to 160 V</b>              | 0.95  | 0.97  | 1.00   | 1.03   | 1.04  | 1.04  | 1.04        |  |      |      |      |      |      |           |       |       |        |        |       |       |             |                                      |  |  |  |  |  |  |  |                     |      |      |      |      |      |      |      |                     |      |      |      |      |      |      |      |                      |      |      |      |      |      |      |      |                                  |  |  |  |  |  |  |  |                     |      |      |      |      |      |      |      |                     |      |      |      |      |      |      |      |                     |      |      |      |      |      |      |      |                                  |  |  |  |  |  |  |  |                     |      |      |      |      |      |      |      |                     |      |      |      |      |      |      |      |                     |      |      |      |      |      |      |      |
| <b>200 to 350 V</b>              | 0.84  | 0.88  | 1.00   | 1.12   | 1.17  | 1.20  | 1.20        |  |      |      |      |      |      |           |       |       |        |        |       |       |             |                                      |  |  |  |  |  |  |  |                     |      |      |      |      |      |      |      |                     |      |      |      |      |      |      |      |                      |      |      |      |      |      |      |      |                                  |  |  |  |  |  |  |  |                     |      |      |      |      |      |      |      |                     |      |      |      |      |      |      |      |                     |      |      |      |      |      |      |      |                                  |  |  |  |  |  |  |  |                     |      |      |      |      |      |      |      |                     |      |      |      |      |      |      |      |                     |      |      |      |      |      |      |      |
| <b>400 to 500 V</b>              | 0.79  | 0.84  | 1.00   | 1.18   | 1.26  | 1.31  | 1.32        |  |      |      |      |      |      |           |       |       |        |        |       |       |             |                                      |  |  |  |  |  |  |  |                     |      |      |      |      |      |      |      |                     |      |      |      |      |      |      |      |                      |      |      |      |      |      |      |      |                                  |  |  |  |  |  |  |  |                     |      |      |      |      |      |      |      |                     |      |      |      |      |      |      |      |                     |      |      |      |      |      |      |      |                                  |  |  |  |  |  |  |  |                     |      |      |      |      |      |      |      |                     |      |      |      |      |      |      |      |                     |      |      |      |      |      |      |      |
| Low Temperature Characteristics  | Impedance ratio: $Z_{-20°C} / Z_{+25°C}$<br>≤ 20 (6.3–10 Vdc)<br>≤ 8 (16–50 Vdc)<br>≤ 4 (63–100 Vdc)<br>≤ 3 (150–550 Vdc)   |       |        |        |       |       |             |  |      |      |      |      |      |           |       |       |        |        |       |       |             |                                      |  |  |  |  |  |  |  |                     |      |      |      |      |      |      |      |                     |      |      |      |      |      |      |      |                      |      |      |      |      |      |      |      |                                  |  |  |  |  |  |  |  |                     |      |      |      |      |      |      |      |                     |      |      |      |      |      |      |      |                     |      |      |      |      |      |      |      |                                  |  |  |  |  |  |  |  |                     |      |      |      |      |      |      |      |                     |      |      |      |      |      |      |      |                     |      |      |      |      |      |      |      |
| Endurance Life Test              | 5000 h at full load at 85 °C<br>Δ Capacitance ±20%<br>ESR 200% of limit<br>DCL 100% of limit  |       |        |        |       |       |             |  |      |      |      |      |      |           |       |       |        |        |       |       |             |                                      |  |  |  |  |  |  |  |                     |      |      |      |      |      |      |      |                     |      |      |      |      |      |      |      |                      |      |      |      |      |      |      |      |                                  |  |  |  |  |  |  |  |                     |      |      |      |      |      |      |      |                     |      |      |      |      |      |      |      |                     |      |      |      |      |      |      |      |                                  |  |  |  |  |  |  |  |                     |      |      |      |      |      |      |      |                     |      |      |      |      |      |      |      |                     |      |      |      |      |      |      |      |
| Shelf Life Test                  | 500 h at 95 °C<br>Capacitance 100% of limit<br>ESR 100% of limit<br>DCL 100% of limit   |       |        |        |       |       |             |  |      |      |      |      |      |           |       |       |        |        |       |       |             |                                      |  |  |  |  |  |  |  |                     |      |      |      |      |      |      |      |                     |      |      |      |      |      |      |      |                      |      |      |      |      |      |      |      |                                  |  |  |  |  |  |  |  |                     |      |      |      |      |      |      |      |                     |      |      |      |      |      |      |      |                     |      |      |      |      |      |      |      |                                  |  |  |  |  |  |  |  |                     |      |      |      |      |      |      |      |                     |      |      |      |      |      |      |      |                     |      |      |      |      |      |      |      |
| Vibration                        | 10 to 55 Hz, 0.06" and 10 g max, 1.5 h each of 2 axes   |       |        |        |       |       |             |  |      |      |      |      |      |           |       |       |        |        |       |       |             |                                      |  |  |  |  |  |  |  |                     |      |      |      |      |      |      |      |                     |      |      |      |      |      |      |      |                      |      |      |      |      |      |      |      |                                  |  |  |  |  |  |  |  |                     |      |      |      |      |      |      |      |                     |      |      |      |      |      |      |      |                     |      |      |      |      |      |      |      |                                  |  |  |  |  |  |  |  |                     |      |      |      |      |      |      |      |                     |      |      |      |      |      |      |      |                     |      |      |      |      |      |      |      |
| <b>RoHS Compliant</b>            |   |       |        |        |       |       |             |  |      |      |      |      |      |           |       |       |        |        |       |       |             |                                      |  |  |  |  |  |  |  |                     |      |      |      |      |      |      |      |                     |      |      |      |      |      |      |      |                      |      |      |      |      |      |      |      |                                  |  |  |  |  |  |  |  |                     |      |      |      |      |      |      |      |                     |      |      |      |      |      |      |      |                     |      |      |      |      |      |      |      |                                  |  |  |  |  |  |  |  |                     |      |      |      |      |      |      |      |                     |      |      |      |      |      |      |      |                     |      |      |      |      |      |      |      |

# Type 500C 95 °C Long Life, Screw Terminal, Aluminum

## Long Life, High Capacitance Screw Terminal Type

### Part Numbering System

|             |   |   |  |                  |                                      |   |  |
|-------------|---|---|--|------------------|--------------------------------------|---|--|
| <b>500C</b> | <b>492</b>  | <b>T</b>                                | <b>200</b>                                     | <b>CB</b>        | <b>2</b>                             | <b>B</b>  | <b>S</b>   |
|             |   |   |  |                  |                                      |   |  |
| <b>Type</b> | <b>Capacitance</b>  | <b>Tolerance</b>                        | <b>Voltage</b>                                 | <b>Case Code</b> | <b>Insulation</b>                    | <b>Terminal</b>   | <b>Can Style</b>   |
|             | 100 = 10 µF<br>101 = 100 µF<br>492 = 4900 µF<br>433 = 43,000 µF | M = ±20%<br>U = -10%+75%<br>T = 10%+50% | 6R3 = 6.3 Vdc<br>063 = 63 Vdc<br>200 = 200 Vdc |                  | 0 = None<br>1 = Polyester<br>2 = PVC | A = Low Post<br>B = High Post<br>D = High Current, Low Post<br>E = High Current, High Post<br>F or M = M5 Post<br>G = M6 Low Post<br>H = M6 High Post | Blank = Standard Can<br>S = Stud Bottom<br>P = Stud with Thermal Pad |

Standard insulation is 0.008-in PVC sleeve with 0.01-in polypropylene end disk. Polyester insulation is not available for 3.5 inch diameter units.

### Outline Drawing

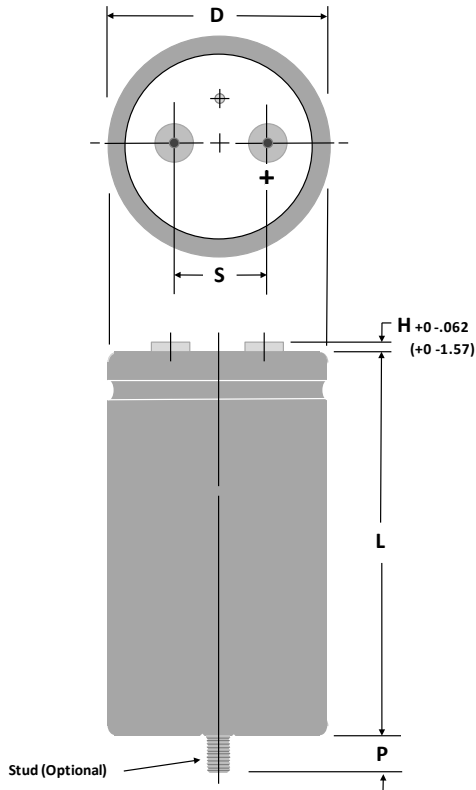

### Stud Dimensions

| Case  | Stud   | P ± 0.039"    |
|-------|--------|---------------|
| Diam. | Thread | (±1.0 mm)     |
| 1.375 | M8     | 0.470" (12.0) |
| 1.750 | M8     | 0.470" (12.0) |
| 2.000 | M12    | 0.630" (16.0) |
| 2.500 | M12    | 0.630" (16.0) |
| 3.000 | M12    | 0.630" (16.0) |
| 3.500 | M12    | 0.630" (16.0) |

NOTE: With the stud-mount feature, a thermally-conductive disk can be inserted in the bottom flush with the outer insulating sleeve. This reduces the thermal resistance through the can bottom by 0.3 °C/W. Can Style P.

### Terminal Dimensions

| Terminal Style     | For Case Diameters | Code | Post Diameter |      | H max |     | Thread | min Full Thread |      | Torque |      |
|--------------------|--------------------|------|---------------|------|-------|-----|--------|-----------------|------|--------|------|
|                    |                    |      | in            | mm   | in    | mm  |        | in              | mm   | in-lb  | N-m  |
| Low Post           | 1 3/8 to 3         | A    | 0.314         | 8.0  | 0.094 | 2.4 | 10-32  | 0.218           | 5.5  | 25     | 2.82 |
| High Post          | 1 3/8 to 3         | B    | 0.314         | 8.0  | 0.281 | 7.1 | 10-32  | 0.375           | 9.5  | 25     | 2.82 |
| High Current, Low  | 2 1/2 to 3 1/2     | D    | 0.684         | 17.4 | 0.125 | 3.2 | 1/4-28 | 0.344           | 8.7  | 50     | 5.65 |
| High Current, High | 2 1/2 to 3 1/2     | E    | 0.684         | 17.4 | 0.281 | 7.1 | 1/4-28 | 0.469           | 11.9 | 60     | 6.78 |
| M5 Post, Small     | 1 3/8 to 2         | M    | 0.314         | 8.0  | 0.281 | 7.1 | M5     | 0.375           | 9.5  | 25     | 2.82 |
| M5 Post            | 2 1/2 & 3          | F    | 0.512         | 13.0 | 0.230 | 5.8 | M5     | 0.344           | 8.7  | 25     | 2.82 |
| M6 Low Post        | 2 1/2 to 3 1/2     | G    | 0.684         | 17.4 | 0.125 | 3.2 | M6     | 0.344           | 8.7  | 50     | 5.65 |
| M6 High Post       | 2 1/2 to 3 1/2     | H    | 0.684         | 17.4 | 0.281 | 7.1 | M6     | 0.469           | 11.9 | 60     | 6.78 |

NOTE: Only high post and M5 post terminals are available at 550 Vdc as they meet the required creepage distance.

# Type 500C 95 °C Long Life, Screw Terminal, Aluminum

## Long Life, High Capacitance Screw Terminal Type

### Uninsulated Case Dimensions

For insulated case, add 0.024"(0.610 mm) to "D" and 0.030"(0.762 mm) to length.

| Case Code | Diam. (D)    |         | Length (L)   |          | Terminals (S) |         | Typical Weight |      |
|-----------|--------------|---------|--------------|----------|---------------|---------|----------------|------|
|           | ±.031 Inches | ±.78 mm | ±.062 Inches | ±1.57 mm | ±0.015 Inches | ±.38 mm | oz             | g    |
| AK        | 1.375        | 34.93   | 1.625        | 41.28    | 0.50          | 12.70   | 1.9            | 54   |
| AA        | 1.375        | 34.93   | 2.125        | 53.98    | 0.50          | 12.70   | 2.0            | 57   |
| AH        | 1.375        | 34.93   | 2.625        | 66.68    | 0.50          | 12.70   | 2.7            | 77   |
| AB        | 1.375        | 34.93   | 3.125        | 79.38    | 0.50          | 12.70   | 3.3            | 94   |
| AJ        | 1.375        | 34.93   | 3.625        | 92.08    | 0.50          | 12.70   | 3.8            | 108  |
| AC        | 1.375        | 34.93   | 4.125        | 104.78   | 0.50          | 12.70   | 4.4            | 125  |
| AD        | 1.375        | 34.93   | 4.625        | 117.48   | 0.50          | 12.70   | 5.1            | 145  |
| AE        | 1.375        | 34.93   | 5.125        | 130.18   | 0.50          | 12.70   | 6.8            | 193  |
| AF        | 1.375        | 34.93   | 5.625        | 142.88   | 0.50          | 12.70   | 8.1            | 230  |
| EA        | 1.750        | 44.45   | 2.125        | 53.98    | 0.75          | 19.05   | 2.7            | 76   |
| EH        | 1.750        | 44.45   | 2.625        | 66.68    | 0.75          | 19.05   | 3.8            | 108  |
| EB        | 1.750        | 44.45   | 3.125        | 79.38    | 0.75          | 19.05   | 5.1            | 145  |
| EJ        | 1.750        | 44.45   | 3.625        | 92.08    | 0.75          | 19.05   | 6.8            | 193  |
| EC        | 1.750        | 44.45   | 4.125        | 104.78   | 0.75          | 19.05   | 8.1            | 230  |
| ED        | 1.750        | 44.45   | 4.625        | 117.48   | 0.75          | 19.05   | 9.0            | 255  |
| EE        | 1.750        | 44.45   | 5.125        | 130.18   | 0.75          | 19.05   | 9.5            | 269  |
| EF        | 1.750        | 44.45   | 5.625        | 142.88   | 0.75          | 19.05   | 10.5           | 298  |
| BA        | 2.000        | 50.80   | 2.125        | 53.98    | 0.88          | 22.23   | 5.4            | 153  |
| BH        | 2.000        | 50.80   | 2.625        | 66.68    | 0.88          | 22.23   | 6.1            | 173  |
| BB        | 2.000        | 50.80   | 3.125        | 79.38    | 0.88          | 22.23   | 6.8            | 193  |
| BJ        | 2.000        | 50.80   | 3.625        | 92.08    | 0.88          | 22.23   | 8.2            | 232  |
| BC        | 2.000        | 50.80   | 4.125        | 104.78   | 0.88          | 22.23   | 9.5            | 269  |
| BD        | 2.000        | 50.80   | 4.625        | 117.48   | 0.88          | 22.23   | 10.3           | 292  |
| BE        | 2.000        | 50.80   | 5.125        | 130.18   | 0.88          | 22.23   | 10.7           | 303  |
| BF        | 2.000        | 50.80   | 5.625        | 142.88   | 0.88          | 22.23   | 13.0           | 369  |
| CH        | 2.500        | 63.50   | 2.625        | 66.68    | 1.13          | 28.58   | 9.2            | 261  |
| CB        | 2.500        | 63.50   | 3.125        | 79.38    | 1.13          | 28.58   | 10.4           | 295  |
| CJ        | 2.500        | 63.50   | 3.625        | 92.08    | 1.13          | 28.58   | 12.7           | 361  |
| CC        | 2.500        | 63.50   | 4.125        | 104.78   | 1.13          | 28.58   | 15.0           | 425  |
| CD        | 2.500        | 63.50   | 4.625        | 117.48   | 1.13          | 28.58   | 17.2           | 488  |
| CE        | 2.500        | 63.50   | 5.125        | 130.18   | 1.13          | 28.58   | 19.3           | 547  |
| CF        | 2.500        | 63.50   | 5.625        | 142.88   | 1.13          | 28.58   | 21.4           | 607  |
| DB        | 3.000        | 76.20   | 3.125        | 79.38    | 1.25          | 31.75   | 16.7           | 473  |
| DJ        | 3.000        | 76.20   | 3.625        | 92.08    | 1.25          | 31.75   | 20.0           | 567  |
| DC        | 3.000        | 76.20   | 4.125        | 104.78   | 1.25          | 31.75   | 22.2           | 629  |
| DD        | 3.000        | 76.20   | 4.625        | 117.48   | 1.25          | 31.75   | 25.5           | 723  |
| DE        | 3.000        | 76.20   | 5.125        | 130.18   | 1.25          | 31.75   | 30.0           | 850  |
| DF        | 3.000        | 76.20   | 5.625        | 142.88   | 1.25          | 31.75   | 31.9           | 904  |
| DP        | 3.000        | 76.20   | 5.875        | 149.23   | 1.25          | 31.75   | 32.8           | 931  |
| DN        | 3.000        | 76.20   | 7.625        | 193.68   | 1.25          | 31.75   | 39.5           | 1119 |
| DG        | 3.000        | 76.20   | 8.625        | 219.08   | 1.25          | 31.75   | 43.3           | 1227 |
| FC        | 3.500        | 88.90   | 4.125        | 104.78   | 1.25          | 31.75   | 30.0           | 850  |
| FD        | 3.500        | 88.90   | 4.625        | 117.48   | 1.25          | 31.75   | 34.4           | 976  |
| FE        | 3.500        | 88.90   | 5.125        | 130.18   | 1.25          | 31.75   | 40.5           | 1148 |
| FF        | 3.500        | 88.90   | 5.625        | 142.88   | 1.25          | 31.75   | 43.1           | 1221 |
| FP        | 3.500        | 88.90   | 5.875        | 149.23   | 1.25          | 31.75   | 44.3           | 1257 |
| FN        | 3.500        | 88.90   | 7.625        | 193.68   | 1.25          | 31.75   | 53.3           | 1512 |
| FG        | 3.500        | 88.90   | 8.625        | 219.08   | 1.25          | 31.75   | 58.5           | 1658 |

# Type 500C 95 °C Long Life, Screw Terminal, Aluminum

## Long Life, High Capacitance Screw Terminal Type Ratings

| Cap. (µF)                    | Catalog Part Number | ESR Max. @ 25 °C 120 Hz (mΩ) | Ripple Max. @ 85°C 120 Hz (A) | Nominal Size D x L (inches) |
|------------------------------|---------------------|------------------------------|-------------------------------|-----------------------------|
| <b>6.3 Vdc (8 Vdc Surge)</b> |                     |                              |                               |                             |
| 27000                        | 500C273U6R3AK2B     | 46.9                         | 4.70                          | 1 3/8 x 1 5/8               |
| 55000                        | 500C553U6R3AA2B     | 26.5                         | 6.90                          | 1 3/8 x 2 1/8               |
| 66000                        | 500C663U6R3AH2B     | 18.8                         | 8.90                          | 1 3/8 x 2 5/8               |
| 87000                        | 500C873U6R3AB2B     | 14.7                         | 10.70                         | 1 3/8 x 3 1/8               |
| 96000                        | 500C963U6R3EA2B     | 18.8                         | 9.60                          | 1 3/4 x 2 1/8               |
| 110000                       | 500C114U6R3AJ2B     | 12.8                         | 12.10                         | 1 3/8 x 3 5/8               |
| 120000                       | 500C124U6R3EH2B     | 14.3                         | 11.80                         | 1 3/4 x 2 5/8               |
| 120000                       | 500C124U6R3BA2B     | 14.2                         | 12.00                         | 2 x 2 1/8                   |
| 130000                       | 500C134U6R3AC2B     | 11.0                         | 13.70                         | 1 3/8 x 4 1/8               |
| 140000                       | 500C144U6R3BH2B     | 9.9                          | 15.50                         | 2 x 2 5/8                   |
| 150000                       | 500C154U6R3AD2B     | 9.8                          | 15.20                         | 1 3/8 x 4 5/8               |
| 160000                       | 500C164U6R3EB2B     | 11.0                         | 14.30                         | 1 3/4 x 3 1/8               |
| 170000                       | 500C174U6R3AE2B     | 8.9                          | 16.50                         | 1 3/8 x 5 1/8               |
| 190000                       | 500C194U6R3AF2B     | 8.3                          | 17.80                         | 1 3/8 x 5 5/8               |
| 190000                       | 500C194U6R3EJ2B     | 9.1                          | 16.60                         | 1 3/4 x 3 5/8               |
| 200000                       | 500C204U6R3BB2B     | 7.8                          | 18.40                         | 2 x 3 1/8                   |
| 230000                       | 500C234U6R3EC2B     | 7.9                          | 18.70                         | 1 3/4 x 4 1/8               |
| 250000                       | 500C254U6R3BJ2B     | 6.5                          | 21.40                         | 2 x 3 5/8                   |
| 250000                       | 500C254U6R3CH2B     | 6.9                          | 21.20                         | 2 1/2 x 2 5/8               |
| 270000                       | 500C274U6R3ED2B     | 7.0                          | 20.60                         | 1 3/4 x 4 5/8               |
| 300000                       | 500C304U6R3BC2B     | 5.6                          | 24.10                         | 2 x 4 1/8                   |
| 310000                       | 500C314U6R3EE2B     | 6.4                          | 22.40                         | 1 3/4 x 5 1/8               |
| 340000                       | 500C344U6R3CB2B     | 5.3                          | 25.80                         | 2 1/2 x 3 1/8               |
| 350000                       | 500C354U6R3EF2B     | 6.0                          | 24.00                         | 1 3/4 x 5 5/8               |
| 360000                       | 500C364U6R3BD2B     | 5.0                          | 26.60                         | 2 x 4 5/8                   |
| 410000                       | 500C414U6R3BE2B     | 4.5                          | 28.80                         | 2 x 5 1/8                   |
| 420000                       | 500C424U6R3CJ2B     | 4.3                          | 29.90                         | 2 1/2 x 3 5/8               |
| 450000                       | 500C454U6R3BF2D     | 4.2                          | 30.90                         | 2 x 5 5/8                   |
| 500000                       | 500C504U6R3DB2D     | 4.1                          | 32.90                         | 3 x 3 1/8                   |
| 510000                       | 500C514U6R3CC2D     | 3.8                          | 33.40                         | 2 1/2 x 4 1/8               |
| 580000                       | 500C584U6R3CD2D     | 3.4                          | 36.80                         | 2 1/2 x 4 5/8               |
| 620000                       | 500C624U6R3DJ2D     | 3.3                          | 38.20                         | 3 x 3 5/8                   |
| 680000                       | 500C684U6R3CE2D     | 3.1                          | 40.00                         | 2 1/2 x 5 1/8               |
| 740000                       | 500C744U6R3DC2D     | 2.9                          | 42.50                         | 3 x 4 1/8                   |
| 760000                       | 500C764U6R3CF2D     | 2.8                          | 42.90                         | 2 1/2 x 5 5/8               |
| 880000                       | 500C884U6R3DD2D     | 2.6                          | 46.70                         | 3 x 4 5/8                   |
| 980000                       | 500C984U6R3DE2D     | 2.4                          | 50.60                         | 3 x 5 1/8                   |
| 1100000                      | 500C115U6R3DF2D     | 2.4                          | 51.30                         | 3 x 5 5/8                   |
| 1100000                      | 500C115U6R3FC2D     | 3.0                          | 46.40                         | 3 1/2 x 4 1/8               |
| 1100000                      | 500C115U6R3FD2D     | 2.6                          | 51.00                         | 3 1/2 x 4 5/8               |
| 1200000                      | 500C125U6R3DP2D     | 2.4                          | 52.00                         | 3 x 5 7/8                   |
| 1400000                      | 500C145U6R3FE2D     | 2.4                          | 55.40                         | 3 1/2 x 5 1/8               |
| 1600000                      | 500C165U6R3FF2D     | 2.4                          | 56.10                         | 3 1/2 x 5 5/8               |

| Cap. (µF)                    | Catalog Part Number | ESR Max. @ 25 °C 120 Hz (mΩ) | Ripple Max. @ 85°C 120 Hz (A) | Nominal Size D x L (inches) |
|------------------------------|---------------------|------------------------------|-------------------------------|-----------------------------|
| <b>6.3 Vdc (8 Vdc Surge)</b> |                     |                              |                               |                             |
| 1600000                      | 500C165U6R3DN2D     | 2.6                          | 55.90                         | 3 x 7 5/8                   |
| 1700000                      | 500C175U6R3FP2D     | 2.4                          | 57.00                         | 3 1/2 x 5 7/8               |
| 1800000                      | 500C185U6R3DG2D     | 2.4                          | 58.60                         | 3 x 8 5/8                   |
| 2300000                      | 500C235U6R3FN2D     | 2.4                          | 61.70                         | 3 1/2 x 7 5/8               |
| 2600000                      | 500C265U6R3FG2D     | 2.4                          | 64.40                         | 3 1/2 x 8 5/8               |
| <b>10 Vdc (12 Vdc Surge)</b> |                     |                              |                               |                             |
| 22000                        | 500C223U010AK2B     | 46.9                         | 4.70                          | 1 3/8 x 1 5/8               |
| 39000                        | 500C393U010AA2B     | 26.5                         | 6.90                          | 1 3/8 x 2 1/8               |
| 52000                        | 500C523U010AH2B     | 20.1                         | 8.60                          | 1 3/8 x 2 5/8               |
| 70000                        | 500C703U010AB2B     | 15.5                         | 10.50                         | 1 3/8 x 3 1/8               |
| 71000                        | 500C713U010EA2B     | 18.8                         | 9.60                          | 1 3/4 x 2 1/8               |
| 87000                        | 500C873U010AJ2B     | 12.8                         | 12.10                         | 1 3/8 x 3 5/8               |
| 95000                        | 500C953U010EH2B     | 14.3                         | 11.80                         | 1 3/4 x 2 5/8               |
| 100000                       | 500C104U010AC2B     | 11.0                         | 13.70                         | 1 3/8 x 4 1/8               |
| 100000                       | 500C104U010BA2B     | 17.6                         | 10.70                         | 2 x 2 1/8                   |
| 120000                       | 500C124U010AD2B     | 9.8                          | 15.20                         | 1 3/8 x 4 5/8               |
| 130000                       | 500C134U010EB2B     | 11.0                         | 14.30                         | 1 3/4 x 3 1/8               |
| 130000                       | 500C134U010BH2B     | 13.4                         | 13.30                         | 2 x 2 5/8                   |
| 140000                       | 500C144U010AE2B     | 8.9                          | 16.50                         | 1 3/8 x 5 1/8               |
| 160000                       | 500C164U010AF2B     | 8.3                          | 17.80                         | 1 3/8 x 5 5/8               |
| 160000                       | 500C164U010EJ2B     | 9.1                          | 16.60                         | 1 3/4 x 3 5/8               |
| 160000                       | 500C164U010BB2B     | 10.5                         | 16.00                         | 2 x 3 1/8                   |
| 190000                       | 500C194U010EC2B     | 7.9                          | 18.70                         | 1 3/4 x 4 1/8               |
| 200000                       | 500C204U010BJ2B     | 8.7                          | 18.50                         | 2 x 3 5/8                   |
| 200000                       | 500C204U010CH2B     | 8.8                          | 18.90                         | 2 1/2 x 2 5/8               |
| 220000                       | 500C224U010ED2B     | 7.0                          | 20.60                         | 1 3/4 x 4 5/8               |
| 240000                       | 500C244U010BC2B     | 7.5                          | 20.80                         | 2 x 4 1/8                   |
| 250000                       | 500C254U010EE2B     | 6.4                          | 22.40                         | 1 3/4 x 5 1/8               |
| 270000                       | 500C274U010CB2B     | 6.7                          | 22.90                         | 2 1/2 x 3 1/8               |
| 280000                       | 500C284U010EF2B     | 6.0                          | 24.00                         | 1 3/4 x 5 5/8               |
| 280000                       | 500C284U010BD2B     | 6.7                          | 22.90                         | 2 x 4 5/8                   |
| 320000                       | 500C324U010BE2B     | 6.1                          | 24.80                         | 2 x 5 1/8                   |
| 340000                       | 500C344U010CJ2B     | 5.5                          | 26.50                         | 2 1/2 x 3 5/8               |
| 360000                       | 500C364U010BF2B     | 5.7                          | 26.50                         | 2 x 5 5/8                   |
| 400000                       | 500C404U010DB2D     | 4.1                          | 32.90                         | 3 x 3 1/8                   |
| 410000                       | 500C414U010CC2B     | 4.8                          | 29.60                         | 2 1/2 x 4 1/8               |
| 480000                       | 500C484U010CD2D     | 4.3                          | 32.60                         | 2 1/2 x 4 5/8               |
| 500000                       | 500C504U010DJ2D     | 3.3                          | 38.20                         | 3 x 3 5/8                   |
| 550000                       | 500C554U010CE2D     | 3.9                          | 35.30                         | 2 1/2 x 5 1/8               |
| 600000                       | 500C604U010DC2D     | 2.9                          | 42.50                         | 3 x 4 1/8                   |
| 610000                       | 500C614U010CF2D     | 3.6                          | 37.90                         | 2 1/2 x 5 5/8               |
| 700000                       | 500C704U010DD2D     | 2.6                          | 46.70                         | 3 x 4 5/8                   |
| 800000                       | 500C804U010DE2D     | 2.4                          | 50.60                         | 3 x 5 1/8                   |

# Type 500C 95 °C Long Life, Screw Terminal, Aluminum

## Long Life, High Capacitance Screw Terminal Type

| Cap. (µF)                    | Catalog Part Number | ESR Max. @ 25 °C 120 Hz (mΩ) | Ripple Max. @ 85 °C 120 Hz (A) | Nominal Size D x L (inches) |
|------------------------------|---------------------|------------------------------|--------------------------------|-----------------------------|
| 830000                       | 500C834U010FC2D     | 2.9                          | 47.30                          | 3 1/2 x 4 1/8               |
| 870000                       | 500C874U010DF2D     | 2.3                          | 53.00                          | 3 x 5 5/8                   |
| 930000                       | 500C934U010DP2D     | 2.3                          | 53.30                          | 3 x 5 7/8                   |
| 970000                       | 500C974U010FD2D     | 2.8                          | 49.60                          | 3 1/2 x 4 5/8               |
| 1100000                      | 500C115U010FE2D     | 2.5                          | 54.50                          | 3 1/2 x 5 1/8               |
| 1200000                      | 500C125U010FF2D     | 2.2                          | 59.00                          | 3 1/2 x 5 5/8               |
| 1300000                      | 500C135U010FP2D     | 2.1                          | 60.80                          | 3 1/2 x 5 7/8               |
| 1300000                      | 500C135U010DN2D     | 2.1                          | 60.10                          | 3 x 7 5/8                   |
| 1500000                      | 500C155U010DG2D     | 2.1                          | 63.70                          | 3 x 8 5/8                   |
| 1700000                      | 500C175U010FN2D     | 1.8                          | 73.40                          | 3 1/2 x 7 5/8               |
| 2000000                      | 500C205U010FG2D     | 1.5                          | 80.50                          | 3 1/2 x 8 5/8               |
| <b>16 Vdc (20 Vdc Surge)</b> |                     |                              |                                |                             |
| 15000                        | 500C153U016AK2B     | 46.9                         | 4.7                            | 1 3/8 x 1 5/8               |
| 27000                        | 500C273U016AA2B     | 26.5                         | 6.9                            | 1 3/8 x 2 1/8               |
| 36000                        | 500C363U016AH2B     | 20.1                         | 8.6                            | 1 3/8 x 2 5/8               |
| 48000                        | 500C483U016AB2B     | 15.5                         | 10.5                           | 1 3/8 x 3 1/8               |
| 49000                        | 500C493U016EA2B     | 18.8                         | 9.6                            | 1 3/4 x 2 1/8               |
| 61000                        | 500C613U016AJ2B     | 12.8                         | 12.1                           | 1 3/8 x 3 5/8               |
| 66000                        | 500C663U016EH2B     | 15.3                         | 11.4                           | 1 3/4 x 2 5/8               |
| 71000                        | 500C713U016BA2B     | 17.6                         | 10.7                           | 2 x 2 1/8                   |
| 73000                        | 500C733U016AC2B     | 11.0                         | 13.7                           | 1 3/8 x 4 1/8               |
| 85000                        | 500C853U016AD2B     | 9.8                          | 15.20                          | 1 3/8 x 4 5/8               |
| 88000                        | 500C883U016EB2B     | 12.5                         | 13.50                          | 1 3/4 x 3 1/8               |
| 90000                        | 500C903U016BH2B     | 13.4                         | 13.30                          | 2 x 2 5/8                   |
| 97000                        | 500C973U016AE2B     | 8.9                          | 16.50                          | 1 3/8 x 5 1/8               |
| 110000                       | 500C114U016AF2B     | 8.3                          | 17.80                          | 1 3/8 x 5 5/8               |
| 110000                       | 500C114U016EJ2B     | 10.9                         | 15.20                          | 1 3/4 x 3 5/8               |
| 110000                       | 500C114U016BB2B     | 10.5                         | 16.00                          | 2 x 3 1/8                   |
| 130000                       | 500C134U016EC2B     | 9.7                          | 16.90                          | 1 3/4 x 4 1/8               |
| 140000                       | 500C144U016BJ2B     | 8.7                          | 18.50                          | 2 x 3 5/8                   |
| 140000                       | 500C144U016CH2B     | 8.8                          | 18.90                          | 2 1/2 x 2 5/8               |
| 150000                       | 500C154U016ED2B     | 8.8                          | 18.50                          | 1 3/4 x 4 5/8               |
| 170000                       | 500C174U016BC2B     | 7.5                          | 20.80                          | 2 x 4 1/8                   |
| 180000                       | 500C184U016EE2B     | 8.2                          | 19.90                          | 1 3/4 x 5 1/8               |
| 190000                       | 500C194U016CB2B     | 6.7                          | 22.90                          | 2 1/2 x 3 1/8               |
| 200000                       | 500C204U016EF2B     | 7.8                          | 21.10                          | 1 3/4 x 5 5/8               |
| 200000                       | 500C204U016BD2B     | 6.7                          | 22.90                          | 2 x 4 5/8                   |
| 220000                       | 500C224U016BE2B     | 6.1                          | 24.80                          | 2 x 5 1/8                   |
| 230000                       | 500C234U016CJ2B     | 5.5                          | 26.50                          | 2 1/2 x 3 5/8               |
| 250000                       | 500C254U016BF2B     | 5.7                          | 26.50                          | 2 x 5 5/8                   |
| 280000                       | 500C284U016CC2B     | 5.0                          | 29.20                          | 2 1/2 x 4 1/8               |
| 280000                       | 500C284U016DB2D     | 4.2                          | 32.40                          | 3 x 3 1/8                   |
| 320000                       | 500C324U016CD2D     | 4.6                          | 31.40                          | 2 1/2 x 4 5/8               |
| 350000                       | 500C354U016DJ2D     | 3.6                          | 36.80                          | 3 x 3 5/8                   |

| Cap. (µF)                    | Catalog Part Number | ESR Max. @ 25 °C 120 Hz (mΩ) | Ripple Max. @ 85 °C 120 Hz (A) | Nominal Size D x L (inches) |
|------------------------------|---------------------|------------------------------|--------------------------------|-----------------------------|
| 370000                       | 500C374U016CE2D     | 4.4                          | 33.40                          | 2 1/2 x 5 1/8               |
| 420000                       | 500C424U016CF2D     | 4.2                          | 35.20                          | 2 1/2 x 5 5/8               |
| 420000                       | 500C424U016DC2D     | 3.3                          | 40.20                          | 3 x 4 1/8                   |
| 490000                       | 500C494U016DD2D     | 3.1                          | 42.80                          | 3 x 4 5/8                   |
| 550000                       | 500C554U016DE2D     | 2.8                          | 46.20                          | 3 x 5 1/8                   |
| 600000                       | 500C604U016FC2D     | 2.9                          | 47.30                          | 3 1/2 x 4 1/8               |
| 610000                       | 500C614U016DF2D     | 2.8                          | 48.10                          | 3 x 5 5/8                   |
| 640000                       | 500C644U016DP2D     | 2.8                          | 48.80                          | 3 x 5 7/8                   |
| 700000                       | 500C704U016FD2D     | 2.8                          | 49.70                          | 3 1/2 x 4 5/8               |
| 800000                       | 500C804U016FE2D     | 2.5                          | 54.40                          | 3 1/2 x 5 1/8               |
| 870000                       | 500C874U016FF2D     | 2.4                          | 56.70                          | 3 1/2 x 5 5/8               |
| 870000                       | 500C874U016DN2D     | 2.6                          | 54.10                          | 3 x 7 5/8                   |
| 920000                       | 500C924U016FP2D     | 2.4                          | 57.30                          | 3 1/2 x 5 7/8               |
| 1000000                      | 500C105U016DG2D     | 2.6                          | 57.10                          | 3 x 8 5/8                   |
| 1300000                      | 500C135U016FN2D     | 2.3                          | 63.10                          | 3 1/2 x 7 5/8               |
| 1500000                      | 500C155U016FG2D     | 2.3                          | 66.40                          | 3 1/2 x 8 5/8               |
| <b>25 Vdc (30 Vdc Surge)</b> |                     |                              |                                |                             |
| 11000                        | 500C113U025AK2B     | 37.1                         | 5.30                           | 1 3/8 x 1 5/8               |
| 18000                        | 500C183U025AA2B     | 23.6                         | 7.40                           | 1 3/8 x 2 1/8               |
| 26000                        | 500C263U025AH2B     | 16.9                         | 9.40                           | 1 3/8 x 2 5/8               |
| 33000                        | 500C333U025EA2B     | 21.8                         | 8.90                           | 1 3/4 x 2 1/8               |
| 34000                        | 500C343U025AB2B     | 17.1                         | 10.00                          | 1 3/8 x 3 1/8               |
| 39000                        | 500C393U025EH2B     | 19.4                         | 10.20                          | 1 3/4 x 2 5/8               |
| 43000                        | 500C433U025AJ2B     | 17.7                         | 10.30                          | 1 3/8 x 3 5/8               |
| 47000                        | 500C473U025BA2B     | 21.8                         | 9.70                           | 2 x 2 1/8                   |
| 51000                        | 500C513U025AC2B     | 16.3                         | 11.30                          | 1 3/8 x 4 1/8               |
| 53000                        | 500C533U025BH2B     | 16.5                         | 12.00                          | 2 x 2 5/8                   |
| 54000                        | 500C543U025EB2B     | 15.2                         | 12.20                          | 1 3/4 x 3 1/8               |
| 60000                        | 500C603U025AD2B     | 15.4                         | 12.10                          | 1 3/8 x 4 5/8               |
| 69000                        | 500C693U025AE2B     | 14.4                         | 13.00                          | 1 3/8 x 5 1/8               |
| 69000                        | 500C693U025BB2B     | 12.2                         | 14.80                          | 2 x 3 1/8                   |
| 70000                        | 500C703U025EJ2B     | 12.8                         | 14.10                          | 1 3/4 x 3 5/8               |
| 77000                        | 500C773U025AF2B     | 13.4                         | 14.00                          | 1 3/8 x 5 5/8               |
| 82000                        | 500C823U025CH2B     | 9.5                          | 18.10                          | 2 1/2 x 2 5/8               |
| 86000                        | 500C863U025EC2B     | 11.2                         | 15.70                          | 1 3/4 x 4 1/8               |
| 89000                        | 500C893U025BJ2B     | 9.8                          | 17.40                          | 2 x 3 5/8                   |
| 100000                       | 500C104U025ED2B     | 10.2                         | 17.10                          | 1 3/4 x 4 5/8               |
| 110000                       | 500C114U025BC2B     | 8.3                          | 19.70                          | 2 x 4 1/8                   |
| 110000                       | 500C114U025CB2B     | 7.6                          | 21.50                          | 2 1/2 x 3 1/8               |
| 120000                       | 500C124U025EE2B     | 9.6                          | 18.40                          | 1 3/4 x 5 1/8               |
| 130000                       | 500C134U025EF2B     | 9.1                          | 19.50                          | 1 3/4 x 5 5/8               |
| 130000                       | 500C134U025BD2B     | 7.3                          | 21.90                          | 2 x 4 5/8                   |
| 150000                       | 500C154U025BE2B     | 6.6                          | 23.90                          | 2 x 5 1/8                   |
| 150000                       | 500C154U025CJ2B     | 6.4                          | 24.60                          | 2 1/2 x 3 5/8               |

# Type 500C 95 °C Long Life, Screw Terminal, Aluminum

## Long Life, High Capacitance Screw Terminal Type

| Cap. (µF)                    | Catalog Part Number | ESR Max. @ 25 °C 120 Hz (mΩ) | Ripple Max. @ 85°C 120 Hz (A) | Nominal Size D x L (inches) |
|------------------------------|---------------------|------------------------------|-------------------------------|-----------------------------|
| 170000                       | 500C174U025BF2B     | 6.1                          | 25.70                         | 2 x 5 5/8                   |
| 170000                       | 500C174U025DB2B     | 5.0                          | 29.70                         | 3 x 3 1/8                   |
| 180000                       | 500C184U025CC2B     | 5.8                          | 27.00                         | 2 1/2 x 4 1/8               |
| 210000                       | 500C214U025CD2B     | 5.2                          | 29.50                         | 2 1/2 x 4 5/8               |
| 220000                       | 500C224U025DJ2D     | 4.3                          | 31.10                         | 3 x 3 5/8                   |
| 250000                       | 500C254U025CE2D     | 5.0                          | 33.60                         | 2 1/2 x 5 1/8               |
| 270000                       | 500C274U025DC2D     | 3.9                          | 36.90                         | 3 x 4 1/8                   |
| 280000                       | 500C284U025CF2D     | 4.6                          | 33.70                         | 2 1/2 x 5 5/8               |
| 320000                       | 500C324U025DD2D     | 3.5                          | 40.00                         | 3 x 4 5/8                   |
| 370000                       | 500C374U025DE2D     | 3.3                          | 42.70                         | 3 x 5 1/8                   |
| 390000                       | 500C394U025FC2D     | 3.8                          | 40.90                         | 3 1/2 x 4 1/8               |
| 420000                       | 500C424U025DF2D     | 3.2                          | 44.90                         | 3 x 5 5/8                   |
| 440000                       | 500C444U025DP2D     | 3.1                          | 46.50                         | 3 x 5 7/8                   |
| 460000                       | 500C464U025FD2D     | 3.5                          | 44.40                         | 3 1/2 x 4 5/8               |
| 530000                       | 500C534U025FE2D     | 3.2                          | 47.40                         | 3 1/2 x 5 1/8               |
| 600000                       | 500C604U025FF2D     | 3.1                          | 50.20                         | 3 1/2 x 5 5/8               |
| 610000                       | 500C614U025DN2D     | 3.1                          | 50.20                         | 3 x 7 5/8                   |
| 630000                       | 500C634U025FP2D     | 2.9                          | 51.80                         | 3 1/2 x 5 7/8               |
| 710000                       | 500C714U025DG2D     | 3.0                          | 52.80                         | 3 x 8 5/8                   |
| 870000                       | 500C874U025FN2D     | 3.0                          | 55.60                         | 3 1/2 x 7 5/8               |
| 1000000                      | 500C105U025FG2D     | 2.9                          | 58.30                         | 3 1/2 x 8 5/8               |
| <b>35 Vdc (40 Vdc Surge)</b> |                     |                              |                               |                             |
| 6600                         | 500C662U035AK2B     | 41.7                         | 5.00                          | 1 3/8 x 1 5/8               |
| 11000                        | 500C113U035AA2B     | 26.7                         | 6.90                          | 1 3/8 x 2 1/8               |
| 16000                        | 500C163U035AH2B     | 19.5                         | 8.70                          | 1 3/8 x 2 5/8               |
| 20000                        | 500C203U035EA2B     | 22.3                         | 8.80                          | 1 3/4 x 2 1/8               |
| 21000                        | 500C213U035AB2B     | 19.4                         | 9.30                          | 1 3/8 x 3 1/8               |
| 24000                        | 500C243U035EH2B     | 19.2                         | 10.20                         | 1 3/4 x 2 5/8               |
| 26000                        | 500C263U035AJ2B     | 19.7                         | 9.80                          | 1 3/8 x 3 5/8               |
| 26000                        | 500C263U035BA2B     | 24.5                         | 9.10                          | 2 x 2 1/8                   |
| 32000                        | 500C323U035AC2B     | 18.7                         | 10.50                         | 1 3/8 x 4 1/8               |
| 33000                        | 500C333U035BH2B     | 20.1                         | 10.80                         | 2 x 2 5/8                   |
| 34000                        | 500C343U035EB2B     | 15.5                         | 12.10                         | 1 3/4 x 3 1/8               |
| 37000                        | 500C373U035AD2B     | 16.7                         | 11.60                         | 1 3/8 x 4 5/8               |
| 42000                        | 500C423U035AE2B     | 14.8                         | 12.90                         | 1 3/8 x 5 1/8               |
| 43000                        | 500C433U035EJ2B     | 13.2                         | 13.80                         | 1 3/4 x 3 5/8               |
| 43000                        | 500C433U035BB2B     | 15.9                         | 13.00                         | 2 x 3 1/8                   |
| 48000                        | 500C483U035AF2B     | 13.5                         | 14.00                         | 1 3/8 x 5 5/8               |
| 51000                        | 500C513U035CH2B     | 14.8                         | 14.50                         | 2 1/2 x 2 5/8               |
| 53000                        | 500C533U035EC2B     | 11.8                         | 15.30                         | 1 3/4 x 4 1/8               |
| 55000                        | 500C553U035BJ2B     | 13.2                         | 15.00                         | 2 x 3 5/8                   |
| 62000                        | 500C623U035ED2B     | 10.6                         | 16.80                         | 1 3/4 x 4 5/8               |
| 67000                        | 500C673U035BC2B     | 11.6                         | 16.70                         | 2 x 4 1/8                   |
| 71000                        | 500C713U035CB2B     | 11.5                         | 17.50                         | 2 1/2 x 3 1/8               |

| Cap. (µF)                    | Catalog Part Number | ESR Max. @ 25 °C 120 Hz (mΩ) | Ripple Max. @ 85°C 120 Hz (A) | Nominal Size D x L (inches) |
|------------------------------|---------------------|------------------------------|-------------------------------|-----------------------------|
| 71000                        | 500C713U035CB2B     | 11.5                         | 17.50                         | 2 1/2 x 3 1/8               |
| 72000                        | 500C723U035EE2B     | 9.8                          | 18.20                         | 1 3/4 x 5 1/8               |
| 80000                        | 500C803U035BD2B     | 10.5                         | 18.20                         | 2 x 4 5/8                   |
| 82000                        | 500C823U035EF2B     | 9.4                          | 19.20                         | 1 3/4 x 5 5/8               |
| 91000                        | 500C913U035CJ2B     | 9.4                          | 20.30                         | 2 1/2 x 3 5/8               |
| 92000                        | 500C923U035BE2B     | 9.8                          | 19.50                         | 2 x 5 1/8                   |
| 100000                       | 500C104U035BF2B     | 9.4                          | 20.70                         | 2 x 5 5/8                   |
| 110000                       | 500C114U035CC2B     | 8.2                          | 22.60                         | 2 1/2 x 4 1/8               |
| 110000                       | 500C114U035DB2B     | 6.9                          | 25.30                         | 3 x 3 1/8                   |
| 130000                       | 500C134U035CD2B     | 7.4                          | 24.80                         | 2 1/2 x 4 5/8               |
| 140000                       | 500C144U035DJ2B     | 5.7                          | 29.10                         | 3 x 3 5/8                   |
| 150000                       | 500C154U035CE2B     | 6.8                          | 26.80                         | 2 1/2 x 5 1/8               |
| 170000                       | 500C174U035CF2B     | 6.1                          | 29.20                         | 2 1/2 x 5 5/8               |
| 170000                       | 500C174U035DC2D     | 5.2                          | 32.00                         | 3 x 4 1/8                   |
| 200000                       | 500C204U035DD2D     | 4.7                          | 34.80                         | 3 x 4 5/8                   |
| 230000                       | 500C234U035DE2D     | 4.4                          | 37.20                         | 3 x 5 1/8                   |
| 240000                       | 500C244U035FC2D     | 4.9                          | 36.00                         | 3 1/2 x 4 1/8               |
| 260000                       | 500C264U035DF2D     | 4.0                          | 39.90                         | 3 x 5 5/8                   |
| 270000                       | 500C274U035DP2D     | 3.9                          | 41.30                         | 3 x 5 7/8                   |
| 280000                       | 500C284U035FD2D     | 4.5                          | 39.00                         | 3 1/2 x 4 5/8               |
| 330000                       | 500C334U035FE2D     | 4.0                          | 42.60                         | 3 1/2 x 5 1/8               |
| 370000                       | 500C374U035FF2D     | 3.6                          | 46.00                         | 3 1/2 x 5 5/8               |
| 380000                       | 500C384U035DN2D     | 3.8                          | 45.30                         | 3 x 7 5/8                   |
| 390000                       | 500C394U035FP2D     | 3.5                          | 47.50                         | 3 1/2 x 5 7/8               |
| 440000                       | 500C444U035DG2D     | 3.6                          | 48.10                         | 3 x 8 5/8                   |
| 540000                       | 500C544U035FN2D     | 3.4                          | 52.10                         | 3 1/2 x 7 5/8               |
| 630000                       | 500C634U035FG2D     | 3.3                          | 55.20                         | 3 1/2 x 8 5/8               |
| <b>50 Vdc (65 Vdc Surge)</b> |                     |                              |                               |                             |
| 4500                         | 500C452U050AK2B     | 47.9                         | 4.70                          | 1 3/8 x 1 5/8               |
| 7600                         | 500C762U050AA2B     | 30.9                         | 6.40                          | 1 3/8 x 2 1/8               |
| 11000                        | 500C113U050AH2B     | 21.8                         | 8.30                          | 1 3/8 x 2 5/8               |
| 14000                        | 500C143U050AB2B     | 20.9                         | 9.00                          | 1 3/8 x 3 1/8               |
| 14000                        | 500C143U050EA2B     | 22.8                         | 8.70                          | 1 3/4 x 2 1/8               |
| 16000                        | 500C163U050EH2B     | 20.2                         | 10.00                         | 1 3/4 x 2 5/8               |
| 17000                        | 500C173U050BA2B     | 25.3                         | 9.00                          | 2 x 2 1/8                   |
| 18000                        | 500C183U050AJ2B     | 17.8                         | 10.30                         | 1 3/8 x 3 5/8               |
| 21000                        | 500C213U050AC2B     | 17.3                         | 11.00                         | 1 3/8 x 4 1/8               |
| 22000                        | 500C223U050BH2B     | 20.8                         | 10.70                         | 2 x 2 5/8                   |
| 23000                        | 500C233U050EB2B     | 15.6                         | 12.10                         | 1 3/4 x 3 1/8               |
| 25000                        | 500C253U050AD2B     | 16.8                         | 11.60                         | 1 3/8 x 4 5/8               |
| 29000                        | 500C293U050AE2B     | 15.1                         | 12.70                         | 1 3/8 x 5 1/8               |
| 29000                        | 500C293U050EJ2B     | 13.5                         | 13.60                         | 1 3/4 x 3 5/8               |
| 29000                        | 500C293U050BB2B     | 16.3                         | 12.80                         | 2 x 3 1/8                   |
| 32000                        | 500C323U050AF2B     | 13.8                         | 13.80                         | 1 3/8 x 5 5/8               |

# Type 500C 95 °C Long Life, Screw Terminal, Aluminum

## Long Life, High Capacitance Screw Terminal Type

| Cap. (µF)                    | Catalog Part Number | ESR Max. @ 25 °C 120 Hz (mΩ) | Ripple Max. @ 85°C 120 Hz (A) | Nominal Size D x L (inches) |
|------------------------------|---------------------|------------------------------|-------------------------------|-----------------------------|
| 34000                        | 500C343U050CH2B     | 15.1                         | 14.40                         | 2 1/2 x 2 5/8               |
| 36000                        | 500C363U050EC2B     | 12.0                         | 15.20                         | 1 3/4 x 4 1/8               |
| 37000                        | 500C373U050BJ2B     | 13.6                         | 14.80                         | 2 x 3 5/8                   |
| 42000                        | 500C423U050ED2B     | 10.8                         | 16.60                         | 1 3/4 x 4 5/8               |
| 46000                        | 500C463U050BC2B     | 11.9                         | 16.50                         | 2 x 4 1/8                   |
| 48000                        | 500C483U050CB2B     | 12.0                         | 17.10                         | 2 1/2 x 3 1/8               |
| 49000                        | 500C493U050EE2B     | 9.8                          | 18.10                         | 1 3/4 x 5 1/8               |
| 54000                        | 500C543U050BD2B     | 10.8                         | 18.00                         | 2 x 4 5/8                   |
| 55000                        | 500C553U050EF2B     | 9.5                          | 19.10                         | 1 3/4 x 5 5/8               |
| 62000                        | 500C623U050BE2B     | 10.0                         | 19.40                         | 2 x 5 1/8                   |
| 62000                        | 500C623U050CJ2B     | 10.3                         | 19.40                         | 2 1/2 x 3 5/8               |
| 70000                        | 500C703U050BF2B     | 9.5                          | 20.50                         | 2 x 5 5/8                   |
| 72000                        | 500C723U050DB2B     | 9.1                          | 22.00                         | 3 x 3 1/8                   |
| 75000                        | 500C753U050CC2B     | 8.9                          | 21.80                         | 2 1/2 x 4 1/8               |
| 89000                        | 500C893U050CD2B     | 7.9                          | 24.00                         | 2 1/2 x 4 5/8               |
| 92000                        | 500C923U050DJ2B     | 7.7                          | 25.10                         | 3 x 3 5/8                   |
| 100000                       | 500C104U050CE2B     | 7.2                          | 26.00                         | 2 1/2 x 5 1/8               |
| 110000                       | 500C114U050DC2B     | 6.9                          | 27.60                         | 3 x 4 1/8                   |
| 120000                       | 500C124U050CF2B     | 6.7                          | 27.90                         | 2 1/2 x 5 5/8               |
| 130000                       | 500C134U050DD2D     | 6.1                          | 30.40                         | 3 x 4 5/8                   |
| 150000                       | 500C154U050DE2D     | 5.9                          | 32.00                         | 3 x 5 1/8                   |
| 150000                       | 500C154U050FC2D     | 6.4                          | 31.70                         | 3 1/2 x 4 1/8               |
| 170000                       | 500C174U050DF2D     | 5.6                          | 33.80                         | 3 x 5 5/8                   |
| 180000                       | 500C184U050DP2D     | 5.4                          | 35.00                         | 3 x 5 7/8                   |
| 180000                       | 500C184U050FD2D     | 5.7                          | 34.70                         | 3 1/2 x 4 5/8               |
| 200000                       | 500C204U050FE2D     | 5.4                          | 36.80                         | 3 1/2 x 5 1/8               |
| 230000                       | 500C234U050FF2D     | 5.0                          | 39.00                         | 3 1/2 x 5 5/8               |
| 250000                       | 500C254U050FP2D     | 5.0                          | 40.00                         | 3 1/2 x 5 7/8               |
| 260000                       | 500C264U050DN2D     | 5.0                          | 42.00                         | 3 x 7 5/8                   |
| 300000                       | 500C304U050DG2D     | 4.0                          | 45.00                         | 3 x 8 5/8                   |
| 340000                       | 500C344U050FN2D     | 4.0                          | 47.00                         | 3 1/2 x 7 5/8               |
| 400000                       | 500C404U050FG2D     | 4.0                          | 51.00                         | 3 1/2 x 8 5/8               |
| <b>63 Vdc (75 Vdc Surge)</b> |                     |                              |                               |                             |
| 3400                         | 500C342U063AK2B     | 60.6                         | 4.10                          | 1 3/8 x 1 5/8               |
| 5800                         | 500C582U063AA2B     | 39.0                         | 5.70                          | 1 3/8 x 2 1/8               |
| 8200                         | 500C822U063AH2B     | 27.4                         | 7.40                          | 1 3/8 x 2 5/8               |
| 11000                        | 500C113U063AB2B     | 25.2                         | 8.20                          | 1 3/8 x 3 1/8               |
| 11000                        | 500C113U063EA2B     | 27.9                         | 7.90                          | 1 3/4 x 2 1/8               |
| 12000                        | 500C123U063EH2B     | 25.6                         | 8.80                          | 1 3/4 x 2 5/8               |
| 13000                        | 500C133U063BA2B     | 28.0                         | 8.50                          | 2 x 2 1/8                   |
| 14000                        | 500C143U063AJ2B     | 23.7                         | 8.90                          | 1 3/8 x 3 5/8               |
| 15000                        | 500C153U063BH2B     | 22.6                         | 10.20                         | 2 x 2 5/8                   |

| Cap. (µF)                    | Catalog Part Number | ESR Max. @ 25 °C 120 Hz (mΩ) | Ripple Max. @ 85°C 120 Hz (A) | Nominal Size D x L (inches) |
|------------------------------|---------------------|------------------------------|-------------------------------|-----------------------------|
| <b>63 Vdc (75 Vdc Surge)</b> |                     |                              |                               |                             |
| 16000                        | 500C163U063AC2B     | 20.4                         | 10.10                         | 1 3/8 x 4 1/8               |
| 17000                        | 500C173U063EB2B     | 19.5                         | 10.80                         | 1 3/4 x 3 1/8               |
| 19000                        | 500C193U063AD2B     | 18.1                         | 11.20                         | 1 3/8 x 4 5/8               |
| 20000                        | 500C203U063BB2B     | 18.1                         | 12.10                         | 2 x 3 1/8                   |
| 22000                        | 500C223U063AE2B     | 16.4                         | 12.20                         | 1 3/8 x 5 1/8               |
| 22000                        | 500C223U063EJ2B     | 16.2                         | 12.50                         | 1 3/4 x 3 5/8               |
| 24000                        | 500C243U063CH2B     | 26.8                         | 10.80                         | 2 1/2 x 2 5/8               |
| 25000                        | 500C253U063AF2B     | 15.1                         | 13.20                         | 1 3/8 x 5 5/8               |
| 26000                        | 500C263U063BJ2B     | 15.1                         | 14.00                         | 2 x 3 5/8                   |
| 27000                        | 500C273U063EC2B     | 14.2                         | 14.00                         | 1 3/4 x 4 1/8               |
| 32000                        | 500C323U063ED2B     | 12.8                         | 15.30                         | 1 3/4 x 4 5/8               |
| 32000                        | 500C323U063BC2B     | 13.3                         | 15.60                         | 2 x 4 1/8                   |
| 34000                        | 500C343U063CB2B     | 19.3                         | 13.50                         | 2 1/2 x 3 1/8               |
| 37000                        | 500C373U063EE2B     | 11.8                         | 16.50                         | 1 3/4 x 5 1/8               |
| 38000                        | 500C383U063BD2B     | 12.1                         | 17.00                         | 2 x 4 5/8                   |
| 42000                        | 500C423U063EF2B     | 11.2                         | 17.60                         | 1 3/4 x 5 5/8               |
| 43000                        | 500C433U063CJ2B     | 17.1                         | 15.10                         | 2 1/2 x 3 5/8               |
| 44000                        | 500C443U063BE2B     | 11.3                         | 18.30                         | 2 x 5 1/8                   |
| 49000                        | 500C493U063BF2B     | 10.7                         | 19.40                         | 2 x 5 5/8                   |
| 50000                        | 500C503U063DB2B     | 14.9                         | 17.20                         | 3 x 3 1/8                   |
| 53000                        | 500C533U063CC2B     | 13.7                         | 17.50                         | 2 1/2 x 4 1/8               |
| 62000                        | 500C623U063CD2B     | 11.8                         | 19.60                         | 2 1/2 x 4 5/8               |
| 65000                        | 500C653U063DJ2B     | 12.1                         | 20.00                         | 3 x 3 5/8                   |
| 72000                        | 500C723U063CE2B     | 11.0                         | 21.10                         | 2 1/2 x 5 1/8               |
| 79000                        | 500C793U063DC2B     | 10.8                         | 22.10                         | 3 x 4 1/8                   |
| 82000                        | 500C823U063CF2B     | 10.5                         | 22.30                         | 2 1/2 x 5 5/8               |
| 93000                        | 500C933U063DD2B     | 9.9                          | 23.90                         | 3 x 4 5/8                   |
| 110000                       | 500C114U063DE2B     | 8.8                          | 26.30                         | 3 x 5 1/8                   |
| 110000                       | 500C114U063FC2D     | 9.9                          | 25.40                         | 3 1/2 x 4 1/8               |
| 120000                       | 500C124U063DF2B     | 7.9                          | 28.50                         | 3 x 5 5/8                   |
| 130000                       | 500C134U063DP2B     | 7.5                          | 29.60                         | 3 x 5 7/8                   |
| 130000                       | 500C134U063FD2D     | 9.0                          | 27.60                         | 3 1/2 x 4 5/8               |
| 150000                       | 500C154U063FE2D     | 7.9                          | 30.30                         | 3 1/2 x 5 1/8               |
| 170000                       | 500C174U063FF2D     | 7.2                          | 32.80                         | 3 1/2 x 5 5/8               |
| 180000                       | 500C184U063DN2D     | 6.5                          | 35.00                         | 3 x 7 5/8                   |
| 180000                       | 500C184U063FP2D     | 6.8                          | 34.00                         | 3 1/2 x 5 7/8               |
| 210000                       | 500C214U063DG2D     | 5.7                          | 38.30                         | 3 x 8 5/8                   |
| 250000                       | 500C254U063FN2D     | 5.8                          | 40.20                         | 3 1/2 x 7 5/8               |
| 290000                       | 500C294U063FG2D     | 5.2                          | 43.90                         | 3 1/2 x 8 5/8               |
| <b>75 Vdc (95 Vdc Surge)</b> |                     |                              |                               |                             |
| 2700                         | 500C272U075AK2B     | 76.2                         | 3.70                          | 1 3/8 x 1 5/8               |

# Type 500C 95 °C Long Life, Screw Terminal, Aluminum

## Long Life, High Capacitance Screw Terminal Type

| Cap. (µF)                    | Catalog Part Number | ESR Max. @ 25 °C 120 Hz (mΩ) | Ripple Max. @ 85°C 120 Hz (A) | Nominal Size D x L (inches) |
|------------------------------|---------------------|------------------------------|-------------------------------|-----------------------------|
| <b>75 Vdc (95 Vdc Surge)</b> |                     |                              |                               |                             |
| 4300                         | 500C432U075AA2B     | 50.7                         | 5.00                          | 1 3/8 x 2 1/8               |
| 6400                         | 500C642U075AH2B     | 35.0                         | 6.50                          | 1 3/8 x 2 5/8               |
| 8300                         | 500C832U075EA2B     | 55.6                         | 5.60                          | 1 3/4 x 2 1/8               |
| 8600                         | 500C862U075AB2B     | 34.0                         | 7.10                          | 1 3/8 x 3 1/8               |
| 9800                         | 500C982U075EH2B     | 47.3                         | 6.50                          | 1 3/4 x 2 5/8               |
| 10000                        | 500C103U075BA2B     | 34.8                         | 7.70                          | 2 x 2 1/8                   |
| 11000                        | 500C113U075AJ2B     | 31.1                         | 7.80                          | 1 3/8 x 3 5/8               |
| 11000                        | 500C113U075BH2B     | 27.5                         | 9.30                          | 2 x 2 5/8                   |
| 13000                        | 500C133U075AC2B     | 28.2                         | 8.60                          | 1 3/8 x 4 1/8               |
| 14000                        | 500C143U075EB2B     | 34.1                         | 8.20                          | 1 3/4 x 3 1/8               |
| 15000                        | 500C153U075AD2B     | 24.5                         | 9.60                          | 1 3/8 x 4 5/8               |
| 16000                        | 500C163U075BB2B     | 21.4                         | 11.20                         | 2 x 3 1/8                   |
| 17000                        | 500C173U075AE2B     | 22.5                         | 10.40                         | 1 3/8 x 5 1/8               |
| 18000                        | 500C183U075EJ2B     | 26.9                         | 9.70                          | 1 3/4 x 3 5/8               |
| 19000                        | 500C193U075AF2B     | 20.4                         | 11.30                         | 1 3/8 x 5 5/8               |
| 19000                        | 500C193U075CH2B     | 30.0                         | 10.20                         | 2 1/2 x 2 5/8               |
| 21000                        | 500C213U075EC2B     | 22.3                         | 11.10                         | 1 3/4 x 4 1/8               |
| 21000                        | 500C213U075BJ2B     | 18.0                         | 12.80                         | 2 x 3 5/8                   |
| 25000                        | 500C253U075ED2B     | 19.2                         | 12.50                         | 1 3/4 x 4 5/8               |
| 25000                        | 500C253U075BC2B     | 15.6                         | 14.40                         | 2 x 4 1/8                   |
| 26000                        | 500C263U075CB2B     | 21.6                         | 12.70                         | 2 1/2 x 3 1/8               |
| 29000                        | 500C293U075EE2B     | 16.9                         | 13.80                         | 1 3/4 x 5 1/8               |
| 30000                        | 500C303U075BD2B     | 13.9                         | 15.80                         | 2 x 4 5/8                   |
| 33000                        | 500C333U075EF2B     | 15.2                         | 15.10                         | 1 3/4 x 5 5/8               |
| 34000                        | 500C343U075BE2B     | 12.8                         | 17.10                         | 2 x 5 1/8                   |
| 34000                        | 500C343U075CJ2B     | 17.8                         | 14.80                         | 2 1/2 x 3 5/8               |
| 39000                        | 500C393U075BF2B     | 12.0                         | 18.30                         | 2 x 5 5/8                   |
| 40000                        | 500C403U075DB2B     | 18.0                         | 15.60                         | 3 x 3 1/8                   |
| 42000                        | 500C423U075CC2B     | 15.1                         | 16.70                         | 2 1/2 x 4 1/8               |
| 49000                        | 500C493U075CD2B     | 13.5                         | 18.40                         | 2 1/2 x 4 5/8               |
| 51000                        | 500C513U075DJ2B     | 14.4                         | 18.30                         | 3 x 3 5/8                   |
| 57000                        | 500C573U075CE2B     | 12.0                         | 20.20                         | 2 1/2 x 5 1/8               |
| 62000                        | 500C623U075DC2B     | 12.9                         | 20.20                         | 3 x 4 1/8                   |
| 64000                        | 500C643U075CF2B     | 11.2                         | 21.50                         | 2 1/2 x 5 5/8               |
| 74000                        | 500C743U075DD2B     | 11.8                         | 21.90                         | 3 x 4 5/8                   |
| 85000                        | 500C853U075DE2B     | 10.4                         | 24.10                         | 3 x 5 1/8                   |
| 85000                        | 500C853U075FC2D     | 11.8                         | 23.20                         | 3 1/2 x 4 1/8               |
| 96000                        | 500C963U075DF2B     | 9.4                          | 26.20                         | 3 x 5 5/8                   |
| 100000                       | 500C104U075DP2B     | 8.9                          | 27.20                         | 3 x 5 7/8                   |
| 100000                       | 500C104U075FD2D     | 10.7                         | 25.30                         | 3 1/2 x 4 5/8               |
| 120000                       | 500C124U075FE2D     | 9.4                          | 27.80                         | 3 1/2 x 5 1/8               |
| 130000                       | 500C134U075FF2D     | 8.4                          | 30.20                         | 3 1/2 x 5 5/8               |
| 140000                       | 500C144U075DN2D     | 7.7                          | 32.10                         | 3 x 7 5/8                   |

| Cap. (µF)                      | Catalog Part Number | ESR Max. @ 25 °C 120 Hz (mΩ) | Ripple Max. @ 85°C 120 Hz (A) | Nominal Size D x L (inches) |
|--------------------------------|---------------------|------------------------------|-------------------------------|-----------------------------|
| 140000                         | 500C144U075FP2D     | 8.1                          | 31.30                         | 3 1/2 x 5 7/8               |
| 160000                         | 500C164U075DG2D     | 6.8                          | 35.10                         | 3 x 8 5/8                   |
| 190000                         | 500C194U075FN2D     | 6.9                          | 36.80                         | 3 1/2 x 7 5/8               |
| 220000                         | 500C224U075FG2D     | 6.2                          | 40.20                         | 3 1/2 x 8 5/8               |
| <b>100 Vdc (125 Vdc Surge)</b> |                     |                              |                               |                             |
| 1600                           | 500C162U100AK2B     | 98.4                         | 3.30                          | 1 3/8 x 1 5/8               |
| 2500                           | 500C252U100AA2B     | 60.2                         | 4.60                          | 1 3/8 x 2 1/8               |
| 3800                           | 500C382U100AH2B     | 42.7                         | 5.90                          | 1 3/8 x 2 5/8               |
| 4900                           | 500C492U100EA2B     | 62.0                         | 5.30                          | 1 3/4 x 2 1/8               |
| 5100                           | 500C512U100AB2B     | 38.2                         | 6.70                          | 1 3/8 x 3 1/8               |
| 5100                           | 500C512U100BA2B     | 51.8                         | 6.30                          | 2 x 2 1/8                   |
| 5800                           | 500C582U100EH2B     | 52.8                         | 6.20                          | 1 3/4 x 2 5/8               |
| 6300                           | 500C632U100AJ2B     | 33.0                         | 7.60                          | 1 3/8 x 3 5/8               |
| 7300                           | 500C732U100BH2B     | 37.8                         | 7.90                          | 2 x 2 5/8                   |
| 7600                           | 500C762U100AC2B     | 30.7                         | 8.20                          | 1 3/8 x 4 1/8               |
| 8100                           | 500C812U100EB2B     | 38.0                         | 7.70                          | 1 3/4 x 3 1/8               |
| 8900                           | 500C892U100AD2B     | 29.0                         | 8.80                          | 1 3/8 x 4 5/8               |
| 10000                          | 500C103U100AE2B     | 28.3                         | 9.30                          | 1 3/8 x 5 1/8               |
| 10000                          | 500C103U100EJ2B     | 29.9                         | 9.20                          | 1 3/4 x 3 5/8               |
| 10000                          | 500C103U100BB2B     | 30.6                         | 9.30                          | 2 x 3 1/8                   |
| 11000                          | 500C113U100AF2B     | 27.6                         | 9.70                          | 1 3/8 x 5 5/8               |
| 12000                          | 500C123U100CH2B     | 33.7                         | 9.60                          | 2 1/2 x 2 5/8               |
| 13000                          | 500C133U100EC2B     | 24.8                         | 10.60                         | 1 3/4 x 4 1/8               |
| 13000                          | 500C133U100BJ2B     | 22.3                         | 11.50                         | 2 x 3 5/8                   |
| 15000                          | 500C153U100ED2B     | 21.2                         | 11.90                         | 1 3/4 x 4 5/8               |
| 16000                          | 500C163U100BC2B     | 19.9                         | 12.80                         | 2 x 4 1/8                   |
| 17000                          | 500C173U100EE2B     | 18.7                         | 13.10                         | 1 3/4 x 5 1/8               |
| 17000                          | 500C173U100CB2B     | 23.4                         | 12.30                         | 2 1/2 x 3 1/8               |
| 19000                          | 500C193U100BD2B     | 17.7                         | 14.10                         | 2 x 4 5/8                   |
| 20000                          | 500C203U100EF2B     | 16.8                         | 14.30                         | 1 3/4 x 5 5/8               |
| 22000                          | 500C223U100BE2B     | 15.6                         | 15.50                         | 2 x 5 1/8                   |
| 22000                          | 500C223U100CJ2B     | 19.1                         | 14.30                         | 2 1/2 x 3 5/8               |
| 25000                          | 500C253U100BF2B     | 14.9                         | 16.40                         | 2 x 5 5/8                   |
| 25000                          | 500C253U100DB2B     | 19.9                         | 14.90                         | 3 x 3 1/8                   |
| 27000                          | 500C273U100CC2B     | 16.5                         | 16.00                         | 2 1/2 x 4 1/8               |
| 32000                          | 500C323U100CD2B     | 14.7                         | 17.60                         | 2 1/2 x 4 5/8               |
| 33000                          | 500C333U100DJ2B     | 16.4                         | 17.20                         | 3 x 3 5/8                   |
| 36000                          | 500C363U100CE2B     | 13.4                         | 19.10                         | 2 1/2 x 5 1/8               |
| 40000                          | 500C403U100DC2B     | 14.4                         | 19.10                         | 3 x 4 1/8                   |
| 41000                          | 500C413U100CF2B     | 12.5                         | 20.40                         | 2 1/2 x 5 5/8               |
| 47000                          | 500C473U100DD2B     | 13.0                         | 20.90                         | 3 x 4 5/8                   |
| 54000                          | 500C543U100DE2B     | 12.0                         | 22.50                         | 3 x 5 1/8                   |
| 55000                          | 500C553U100FC2D     | 13.4                         | 21.80                         | 3 1/2 x 4 1/8               |
| 62000                          | 500C623U100DF2B     | 11.2                         | 23.90                         | 3 x 5 5/8                   |



# Type 500C 95 °C Long Life, Screw Terminal, Aluminum

## Long Life, High Capacitance Screw Terminal Type

| Cap. (µF)                      | Catalog Part Number | ESR Max. @ 25 °C 120 Hz (mΩ) | Ripple Max. @ 85 °C 120 Hz (A) | Nominal Size D x L (inches) |
|--------------------------------|---------------------|------------------------------|--------------------------------|-----------------------------|
| <b>100 Vdc (125 Vdc Surge)</b> |                     |                              |                                |                             |
| 65000                          | 500C653U100DP2B     | 11.1                         | 24.40                          | 3 x 5 7/8                   |
| 65000                          | 500C653U100FD2D     | 12.1                         | 23.80                          | 3 1/2 x 4 5/8               |
| 74000                          | 500C743U100FE2D     | 10.9                         | 25.90                          | 3 1/2 x 5 1/8               |
| 84000                          | 500C843U100FF2D     | 10.2                         | 27.50                          | 3 1/2 x 5 5/8               |
| 89000                          | 500C893U100FP2D     | 10.0                         | 28.10                          | 3 1/2 x 5 7/8               |
| 94000                          | 500C943U100DN2D     | 9.2                          | 29.40                          | 3 x 7 5/8                   |
| 110000                         | 500C114U100DG2D     | 8.2                          | 32.10                          | 3 x 8 5/8                   |
| 120000                         | 500C124U100FN2D     | 8.3                          | 33.70                          | 3 1/2 x 7 5/8               |
| 140000                         | 500C144U100FG2D     | 7.3                          | 36.80                          | 3 1/2 x 8 5/8               |
| <b>160 Vdc (200 Vdc)</b>       |                     |                              |                                |                             |
| 750                            | 500C751T160AK2B     | 150.0                        | 2.60                           | 1 3/8 x 1 5/8               |
| 1200                           | 500C122T160AA2B     | 93.0                         | 3.70                           | 1 3/8 x 2 1/8               |
| 1500                           | 500C152T160AH2B     | 70.5                         | 4.60                           | 1 3/8 x 2 5/8               |
| 2100                           | 500C212T160AB2B     | 58.5                         | 5.40                           | 1 3/8 x 3 1/8               |
| 2300                           | 500C232T160EA2B     | 62.0                         | 5.30                           | 1 3/4 x 2 1/8               |
| 2400                           | 500C242T160BA2B     | 70.5                         | 5.40                           | 2 x 2 1/8                   |
| 2700                           | 500C272T160AJ2B     | 50.2                         | 6.10                           | 1 3/8 x 3 5/8               |
| 2700                           | 500C272T160EH2B     | 52.8                         | 6.20                           | 1 3/4 x 2 5/8               |
| 3300                           | 500C332T160AC2B     | 42.9                         | 7.00                           | 1 3/8 x 4 1/8               |
| 3500                           | 500C352T160BH2B     | 46.5                         | 7.10                           | 2 x 2 5/8                   |
| 3800                           | 500C382T160EB2B     | 38.0                         | 7.70                           | 1 3/4 x 3 1/8               |
| 3900                           | 500C392T160AD2B     | 37.7                         | 7.70                           | 1 3/8 x 4 5/8               |
| 4500                           | 500C452T160AE2B     | 34.7                         | 8.40                           | 1 3/8 x 5 1/8               |
| 4900                           | 500C492T160EJ2B     | 29.9                         | 9.20                           | 1 3/4 x 3 5/8               |
| 4900                           | 500C492T160BB2B     | 33.5                         | 8.90                           | 2 x 3 1/8                   |
| 5100                           | 500C512T160AF2B     | 32.2                         | 9.00                           | 1 3/8 x 5 5/8               |
| 5500                           | 500C552T160CH2B     | 30.1                         | 10.20                          | 2 1/2 x 2 5/8               |
| 6000                           | 500C602T160EC2B     | 24.8                         | 10.60                          | 1 3/4 x 4 1/8               |
| 6300                           | 500C632T160BJ2B     | 26.4                         | 10.60                          | 2 x 3 5/8                   |
| 7100                           | 500C712T160ED2B     | 21.2                         | 11.90                          | 1 3/4 x 4 5/8               |
| 7700                           | 500C772T160BC2B     | 21.9                         | 12.20                          | 2 x 4 1/8                   |
| 7700                           | 500C772T160CB2B     | 21.3                         | 12.80                          | 2 1/2 x 3 1/8               |
| 8200                           | 500C822T160EE2B     | 18.7                         | 13.10                          | 1 3/4 x 5 1/8               |
| 9100                           | 500C912T160BD2B     | 18.8                         | 13.60                          | 2 x 4 5/8                   |
| 9300                           | 500C932T160EF2B     | 16.8                         | 14.30                          | 1 3/4 x 5 5/8               |
| 9900                           | 500C992T160CJ2B     | 17.0                         | 15.10                          | 2 1/2 x 3 5/8               |
| 10000                          | 500C103T160BE2B     | 16.6                         | 15.00                          | 2 x 5 1/8                   |
| 11000                          | 500C113T160DB2B     | 14.7                         | 17.30                          | 3 x 3 1/8                   |
| 12000                          | 500C123T160BF2B     | 14.9                         | 16.40                          | 2 x 5 5/8                   |
| 12000                          | 500C123T160CC2B     | 14.1                         | 17.30                          | 2 1/2 x 4 1/8               |
| 14000                          | 500C143T160CD2B     | 11.9                         | 19.60                          | 2 1/2 x 4 5/8               |

| Cap. (µF)                      | Catalog Part Number | ESR Max. @ 25 °C 120 Hz (mΩ) | Ripple Max. @ 85 °C 120 Hz (A) | Nominal Size D x L (inches) |
|--------------------------------|---------------------|------------------------------|--------------------------------|-----------------------------|
| <b>160 Vdc (200 Vdc)</b>       |                     |                              |                                |                             |
| 15000                          | 500C153T160DJ2B     | 11.5                         | 20.50                          | 3 x 3 5/8                   |
| 16000                          | 500C163T160CE2B     | 10.7                         | 21.30                          | 2 1/2 x 5 1/8               |
| 18000                          | 500C183T160DC2B     | 9.6                          | 23.40                          | 3 x 4 1/8                   |
| 19000                          | 500C193T160CF2B     | 9.6                          | 23.20                          | 2 1/2 x 5 5/8               |
| 21000                          | 500C213T160DD2B     | 8.2                          | 26.20                          | 3 x 4 5/8                   |
| 25000                          | 500C253T160DE2B     | 7.3                          | 28.90                          | 3 x 5 1/8                   |
| 25000                          | 500C253T160FC2D     | 9.2                          | 26.40                          | 3 1/2 x 4 1/8               |
| 28000                          | 500C283T160DF2D     | 6.5                          | 31.40                          | 3 x 5 5/8                   |
| 29000                          | 500C293T160DP2D     | 6.2                          | 32.60                          | 3 x 5 7/8                   |
| 29000                          | 500C293T160FD2D     | 7.9                          | 29.50                          | 3 1/2 x 4 5/8               |
| 34000                          | 500C343T160FE2D     | 6.9                          | 32.40                          | 3 1/2 x 5 1/8               |
| 38000                          | 500C383T160FF2D     | 6.2                          | 35.10                          | 3 1/2 x 5 5/8               |
| 40000                          | 500C403T160FP2D     | 5.9                          | 36.50                          | 3 1/2 x 5 7/8               |
| 41000                          | 500C413T160DN2D     | 5.1                          | 39.80                          | 3 x 7 5/8                   |
| 47000                          | 500C473T160DG2D     | 4.3                          | 44.00                          | 3 x 8 5/8                   |
| 56000                          | 500C563T160FN2D     | 4.9                          | 44.30                          | 3 1/2 x 7 5/8               |
| 65000                          | 500C653T160FG2D     | 4.2                          | 48.80                          | 3 1/2 x 8 5/8               |
| <b>200 Vdc (250 Vdc Surge)</b> |                     |                              |                                |                             |
| 540                            | 500C541T200AK2B     | 206.0                        | 2.30                           | 1 3/8 x 1 5/8               |
| 770                            | 500C771T200AA2B     | 140.0                        | 3.00                           | 1 3/8 x 2 1/8               |
| 970                            | 500C971T200AH2B     | 101.0                        | 3.90                           | 1 3/8 x 2 5/8               |
| 1400                           | 500C142T200AB2B     | 78.5                         | 4.60                           | 1 3/8 x 3 1/8               |
| 1500                           | 500C152T200EA2B     | 79.1                         | 4.70                           | 1 3/4 x 2 1/8               |
| 1600                           | 500C162T200BA2B     | 82.0                         | 5.00                           | 2 x 2 1/8                   |
| 1700                           | 500C172T200AJ2B     | 63.9                         | 5.40                           | 1 3/8 x 3 5/8               |
| 1700                           | 500C172T200EH2B     | 62.5                         | 5.70                           | 1 3/4 x 2 5/8               |
| 2100                           | 500C212T200AC2B     | 51.7                         | 6.30                           | 1 3/8 x 4 1/8               |
| 2200                           | 500C222T200BH2B     | 61.0                         | 6.20                           | 2 x 2 5/8                   |
| 2400                           | 500C242T200EB2B     | 48.4                         | 6.90                           | 1 3/4 x 3 1/8               |
| 2500                           | 500C252T200AD2B     | 43.2                         | 7.20                           | 1 3/8 x 4 5/8               |
| 2900                           | 500C292T200AE2B     | 37.8                         | 8.00                           | 1 3/8 x 5 1/8               |
| 3100                           | 500C312T200EJ2B     | 37.9                         | 8.20                           | 1 3/4 x 3 5/8               |
| 3100                           | 500C312T200BB2B     | 46.1                         | 7.60                           | 2 x 3 1/8                   |
| 3300                           | 500C332T200AF2B     | 33.4                         | 8.90                           | 1 3/8 x 5 5/8               |
| 3500                           | 500C352T200CH2B     | 42.2                         | 8.60                           | 2 1/2 x 2 5/8               |
| 3800                           | 500C382T200EC2B     | 31.3                         | 9.40                           | 1 3/4 x 4 1/8               |
| 4000                           | 500C402T200BJ2B     | 36.2                         | 9.00                           | 2 x 3 5/8                   |
| 4500                           | 500C452T200ED2B     | 26.8                         | 10.60                          | 1 3/4 x 4 5/8               |
| 4900                           | 500C492T200BC2B     | 28.5                         | 10.60                          | 2 x 4 1/8                   |
| 4900                           | 500C492T200CB2B     | 31.2                         | 10.60                          | 2 1/2 x 3 1/8               |
| 5200                           | 500C522T200EE2B     | 23.5                         | 11.70                          | 1 3/4 x 5 1/8               |

# Type 500C 95 °C Long Life, Screw Terminal, Aluminum

## Long Life, High Capacitance Screw Terminal Type

| Cap. (µF)                      | Catalog Part Number | ESR Max. @ 25 °C 120 Hz (mΩ) | Ripple Max. @ 85°C 120 Hz (A) | Nominal Size D x L (inches) |
|--------------------------------|---------------------|------------------------------|-------------------------------|-----------------------------|
| <b>200 Vdc (250 Vdc Surge)</b> |                     |                              |                               |                             |
| 5800                           | 500C582T200BD2B     | 24.4                         | 12.00                         | 2 x 4 5/8                   |
| 5900                           | 500C592T200EF2B     | 21.0                         | 12.80                         | 1 3/4 x 5 5/8               |
| 6200                           | 500C622T200CJ2B     | 22.3                         | 13.20                         | 2 1/2 x 3 5/8               |
| 6700                           | 500C672T200BE2B     | 21.7                         | 13.20                         | 2 x 5 1/8                   |
| 7600                           | 500C762T200BF2B     | 19.6                         | 14.30                         | 2 x 5 5/8                   |
| 7600                           | 500C762T200CC2B     | 20.3                         | 14.40                         | 2 1/2 x 4 1/8               |
| 7600                           | 500C762T200DB2B     | 30.3                         | 12.10                         | 3 x 3 1/8                   |
| 9000                           | 500C902T200CD2B     | 17.3                         | 16.20                         | 2 1/2 x 4 5/8               |
| 9800                           | 500C982T200DJ2B     | 23.7                         | 14.30                         | 3 x 3 5/8                   |
| 10000                          | 500C103T200CE2B     | 15.8                         | 17.60                         | 2 1/2 x 5 1/8               |
| 12000                          | 500C123T200CF2B     | 13.7                         | 19.40                         | 2 1/2 x 5 5/8               |
| 12000                          | 500C123T200DC2B     | 19.7                         | 16.30                         | 3 x 4 1/8                   |
| 14000                          | 500C143T200DD2B     | 16.9                         | 18.30                         | 3 x 4 5/8                   |
| 15000                          | 500C153T200FC2B     | 17.1                         | 19.30                         | 3 1/2 x 4 1/8               |
| 16000                          | 500C163T200FG2B     | 14.8                         | 20.20                         | 3 x 5 1/8                   |
| 18000                          | 500C183T200DF2B     | 13.3                         | 22.00                         | 3 x 5 5/8                   |
| 19000                          | 500C193T200DP2B     | 15.3                         | 20.70                         | 3 x 5 7/8                   |
| 20000                          | 500C203T200FD2B     | 12.7                         | 23.30                         | 3 1/2 x 4 5/8               |
| 21000                          | 500C213T200FE2D     | 13.4                         | 23.30                         | 3 1/2 x 5 1/8               |
| 24000                          | 500C243T200FF2D     | 12.0                         | 25.30                         | 3 1/2 x 5 5/8               |
| 25000                          | 500C253T200FP2D     | 11.5                         | 26.30                         | 3 1/2 x 5 7/8               |
| 26000                          | 500C263T200DN2B     | 11.7                         | 26.40                         | 3 x 7 5/8                   |
| 31000                          | 500C313T200DG2B     | 9.6                          | 29.60                         | 3 x 8 5/8                   |
| 35000                          | 500C353T200FN2D     | 9.3                          | 32.10                         | 3 1/2 x 7 5/8               |
| 40000                          | 500C403T200FG2D     | 7.9                          | 35.50                         | 3 1/2 x 8 5/8               |
| <b>250 Vdc (300 Vdc Surge)</b> |                     |                              |                               |                             |
| 380                            | 500C381T250AK2B     | 260.0                        | 2.00                          | 1 3/8 x 1 5/8               |
| 680                            | 500C681T250AA2B     | 156.0                        | 2.90                          | 1 3/8 x 2 1/8               |
| 830                            | 500C831T250AH2B     | 119.0                        | 3.50                          | 1 3/8 x 2 5/8               |
| 1100                           | 500C112T250AB2B     | 87.5                         | 4.40                          | 1 3/8 x 3 1/8               |
| 1100                           | 500C112T250EA2B     | 99.1                         | 4.20                          | 1 3/4 x 2 1/8               |
| 1200                           | 500C122T250BA2B     | 94.6                         | 4.60                          | 2 x 2 1/8                   |
| 1300                           | 500C132T250EH2B     | 82.8                         | 4.90                          | 1 3/4 x 2 5/8               |
| 1400                           | 500C142T250AJ2B     | 69.5                         | 5.20                          | 1 3/8 x 3 5/8               |
| 1700                           | 500C172T250AC2B     | 57.8                         | 6.00                          | 1 3/8 x 4 1/8               |
| 1700                           | 500C172T250BH2B     | 65.7                         | 6.00                          | 2 x 2 5/8                   |
| 1800                           | 500C182T250EB2B     | 61.1                         | 6.10                          | 1 3/4 x 3 1/8               |
| 2000                           | 500C202T250AD2B     | 51.5                         | 6.60                          | 1 3/8 x 4 5/8               |
| 2300                           | 500C232T250AE2B     | 44.1                         | 7.40                          | 1 3/8 x 5 1/8               |
| 2300                           | 500C232T250EJ2B     | 48.5                         | 7.20                          | 1 3/4 x 3 5/8               |
| 2400                           | 500C242T250BB2B     | 46.2                         | 7.60                          | 2 x 3 1/8                   |
| 2600                           | 500C262T250AF2B     | 38.4                         | 8.30                          | 1 3/8 x 5 5/8               |
| 2600                           | 500C262T250CH2B     | 51.6                         | 7.80                          | 2 1/2 x 2 5/8               |

| Cap. (µF)                      | Catalog Part Number | ESR Max. @ 25 °C 120 Hz (mΩ) | Ripple Max. @ 85°C 120 Hz (A) | Nominal Size D x L (inches) |
|--------------------------------|---------------------|------------------------------|-------------------------------|-----------------------------|
| <b>250 Vdc (300 Vdc Surge)</b> |                     |                              |                               |                             |
| 2800                           | 500C282T250EC2B     | 40.4                         | 8.30                          | 1 3/4 x 4 1/8               |
| 3100                           | 500C312T250BJ2B     | 38.1                         | 8.80                          | 2 x 3 5/8                   |
| 3300                           | 500C332T250ED2B     | 34.7                         | 9.30                          | 1 3/4 x 4 5/8               |
| 3700                           | 500C372T250CB2B     | 32.0                         | 10.50                         | 2 1/2 x 3 1/8               |
| 3800                           | 500C382T250EE2B     | 30.5                         | 10.30                         | 1 3/4 x 5 1/8               |
| 3800                           | 500C382T250BC2B     | 31.4                         | 10.10                         | 2 x 4 1/8                   |
| 4300                           | 500C432T250EF2B     | 27.3                         | 11.20                         | 1 3/4 x 5 5/8               |
| 4500                           | 500C452T250BD2B     | 26.9                         | 11.40                         | 2 x 4 5/8                   |
| 4700                           | 500C472T250CJ2B     | 25.0                         | 12.40                         | 2 1/2 x 3 5/8               |
| 5200                           | 500C522T250BE2B     | 23.6                         | 12.60                         | 2 x 5 1/8                   |
| 5600                           | 500C562T250DB2B     | 27.6                         | 12.60                         | 3 x 3 1/8                   |
| 5800                           | 500C582T250CC2B     | 20.7                         | 14.30                         | 2 1/2 x 4 1/8               |
| 5900                           | 500C592T250BF2B     | 21.0                         | 13.80                         | 2 x 5 5/8                   |
| 6900                           | 500C692T250CD2B     | 17.7                         | 16.10                         | 2 1/2 x 4 5/8               |
| 7200                           | 500C722T250DJ2B     | 21.6                         | 15.00                         | 3 x 3 5/8                   |
| 7900                           | 500C792T250CE2B     | 15.5                         | 17.70                         | 2 1/2 x 5 1/8               |
| 8800                           | 500C882T250DC2B     | 17.6                         | 17.30                         | 3 x 4 1/8                   |
| 9000                           | 500C902T250CF2B     | 13.8                         | 19.40                         | 2 1/2 x 5 5/8               |
| 10000                          | 500C103T250DD2B     | 16.3                         | 18.60                         | 3 x 4 5/8                   |
| 11000                          | 500C113T250FC2D     | 19.5                         | 18.10                         | 3 1/2 x 4 1/8               |
| 12000                          | 500C123T250DE2B     | 14.3                         | 20.60                         | 3 x 5 1/8                   |
| 13000                          | 500C133T250FD2D     | 17.2                         | 19.90                         | 3 1/2 x 4 5/8               |
| 14000                          | 500C143T250DF2B     | 12.0                         | 23.20                         | 3 x 5 5/8                   |
| 15000                          | 500C153T250DP2B     | 11.5                         | 23.90                         | 3 x 5 7/8                   |
| 15000                          | 500C153T250FE2D     | 15.1                         | 22.00                         | 3 1/2 x 5 1/8               |
| 17000                          | 500C173T250FF2D     | 13.2                         | 24.20                         | 3 1/2 x 5 5/8               |
| 18000                          | 500C183T250FP2D     | 12.8                         | 24.80                         | 3 1/2 x 5 7/8               |
| 21000                          | 500C213T250DN2D     | 9.6                          | 30.90                         | 3 x 7 5/8                   |
| 24000                          | 500C243T250DG2D     | 7.0                          | 34.60                         | 3 x 8 5/8                   |
| 25000                          | 500C253T250FN2D     | 10.5                         | 30.00                         | 3 1/2 x 7 5/8               |
| 29000                          | 500C293T250FG2D     | 9.2                          | 33.00                         | 3 1/2 x 8 5/8               |
| <b>300 Vdc (350 Vdc Surge)</b> |                     |                              |                               |                             |
| 290                            | 500C291T300AK2B     | 418.0                        | 1.60                          | 1 3/8 x 1 5/8               |
| 520                            | 500C521T300AA2B     | 231.0                        | 2.30                          | 1 3/8 x 2 1/8               |
| 630                            | 500C631T300AH2B     | 189.0                        | 2.80                          | 1 3/8 x 2 5/8               |
| 870                            | 500C871T300AB2B     | 138.0                        | 3.50                          | 1 3/8 x 3 1/8               |
| 870                            | 500C871T300EA2B     | 139.0                        | 3.50                          | 1 3/4 x 2 1/8               |
| 1000                           | 500C102T300BA2B     | 131.0                        | 3.90                          | 2 x 2 1/8                   |
| 1100                           | 500C112T300AJ2B     | 107.0                        | 4.20                          | 1 3/8 x 3 5/8               |
| 1100                           | 500C112T300EH2B     | 117.0                        | 4.10                          | 1 3/4 x 2 5/8               |
| 1300                           | 500C132T300AC2B     | 90.4                         | 4.80                          | 1 3/8 x 4 1/8               |
| 1300                           | 500C132T300BH2B     | 103.0                        | 4.80                          | 2 x 2 5/8                   |
| 1400                           | 500C142T300EB2B     | 84.5                         | 5.20                          | 1 3/4 x 3 1/8               |

# Type 500C 95 °C Long Life, Screw Terminal, Aluminum

## Long Life, High Capacitance Screw Terminal Type

| Cap. (µF)                      | Catalog Part Number | ESR Max. @ 25 °C 120 Hz (mΩ) | Ripple Max. @ 85°C 120 Hz (A) | Nominal Size D x L (inches) |
|--------------------------------|---------------------|------------------------------|-------------------------------|-----------------------------|
| <b>300 Vdc (350 Vdc Surge)</b> |                     |                              |                               |                             |
| 1600                           | 500C162T300AD2B     | 77.4                         | 5.40                          | 1 3/8 x 4 5/8               |
| 1800                           | 500C182T300AE2B     | 65.7                         | 6.10                          | 1 3/8 x 5 1/8               |
| 1800                           | 500C182T300EJ2B     | 68.3                         | 6.10                          | 1 3/4 x 3 5/8               |
| 1900                           | 500C192T300BB2B     | 71.1                         | 6.10                          | 2 x 3 1/8                   |
| 2000                           | 500C202T300AF2B     | 60.3                         | 6.60                          | 1 3/8 x 5 5/8               |
| 2200                           | 500C222T300EC2B     | 56.7                         | 7.00                          | 1 3/4 x 4 1/8               |
| 2200                           | 500C222T300CH2B     | 60.5                         | 7.20                          | 2 1/2 x 2 5/8               |
| 2400                           | 500C242T300BJ2B     | 55.5                         | 7.30                          | 2 x 3 5/8                   |
| 2600                           | 500C262T300ED2B     | 48.5                         | 7.90                          | 1 3/4 x 4 5/8               |
| 2900                           | 500C292T300BC2B     | 45.7                         | 8.40                          | 2 x 4 1/8                   |
| 2900                           | 500C292T300CB2B     | 46.5                         | 8.70                          | 2 1/2 x 3 1/8               |
| 3000                           | 500C302T300EE2B     | 42.5                         | 8.70                          | 1 3/4 x 5 1/8               |
| 3400                           | 500C342T300EF2B     | 37.9                         | 9.50                          | 1 3/4 x 5 5/8               |
| 3500                           | 500C352T300BD2B     | 38.9                         | 9.50                          | 2 x 4 5/8                   |
| 3700                           | 500C372T300CJ2B     | 38.1                         | 10.10                         | 2 1/2 x 3 5/8               |
| 4000                           | 500C402T300BE2B     | 34.0                         | 10.50                         | 2 x 5 1/8                   |
| 4100                           | 500C412T300DB2B     | 42.8                         | 10.10                         | 3 x 3 1/8                   |
| 4500                           | 500C452T300BF2B     | 30.2                         | 11.50                         | 2 x 5 5/8                   |
| 4500                           | 500C452T300CC2B     | 29.9                         | 11.90                         | 2 1/2 x 4 1/8               |
| 5200                           | 500C522T300DJ2B     | 34.0                         | 11.90                         | 3 x 3 5/8                   |
| 5300                           | 500C532T300CD2B     | 25.5                         | 13.40                         | 2 1/2 x 4 5/8               |
| 6100                           | 500C612T300CE2B     | 22.2                         | 14.80                         | 2 1/2 x 5 1/8               |
| 6400                           | 500C642T300DC2B     | 26.2                         | 14.20                         | 3 x 4 1/8                   |
| 6900                           | 500C692T300CF2B     | 19.8                         | 16.20                         | 2 1/2 x 5 5/8               |
| 7500                           | 500C752T300DD2B     | 23.6                         | 15.50                         | 3 x 4 5/8                   |
| 8700                           | 500C872T300DE2B     | 20.5                         | 17.20                         | 3 x 5 1/8                   |
| 8900                           | 500C892T300FC2D     | 21.0                         | 17.40                         | 3 1/2 x 4 1/8               |
| 9800                           | 500C982T300DF2B     | 18.0                         | 18.90                         | 3 x 5 5/8                   |
| 10000                          | 500C103T300DP2B     | 17.0                         | 19.70                         | 3 x 5 7/8                   |
| 10000                          | 500C103T300FD2D     | 18.2                         | 19.40                         | 3 1/2 x 4 5/8               |
| 12000                          | 500C123T300FE2D     | 16.0                         | 21.30                         | 3 1/2 x 5 1/8               |
| 13000                          | 500C133T300FF2D     | 14.3                         | 23.20                         | 3 1/2 x 5 5/8               |
| 14000                          | 500C143T300FP2D     | 13.5                         | 24.20                         | 3 1/2 x 5 7/8               |
| 15000                          | 500C153T300DN2B     | 13.2                         | 24.90                         | 3 x 7 5/8                   |
| 17000                          | 500C173T300DG2B     | 10.8                         | 27.90                         | 3 x 8 5/8                   |
| 19000                          | 500C193T300FN2D     | 11.0                         | 29.50                         | 3 1/2 x 7 5/8               |
| 22000                          | 500C223T300FG2D     | 9.3                          | 32.60                         | 3 1/2 x 8 5/8               |
| <b>350 Vdc (400 Vdc Surge)</b> |                     |                              |                               |                             |
| 200                            | 500C201T350AK2B     | 605.0                        | 1.30                          | 1 3/8 x 1 5/8               |
| 320                            | 500C321T350AA2B     | 379.0                        | 1.80                          | 1 3/8 x 2 1/8               |
| 470                            | 500C471T350AH2B     | 253.0                        | 2.40                          | 1 3/8 x 2 5/8               |
| 630                            | 500C631T350AB2B     | 190.0                        | 3.00                          | 1 3/8 x 3 1/8               |
| 720                            | 500C721T350EA2B     | 177.0                        | 3.10                          | 1 3/4 x 2 1/8               |

| Cap. (µF)                      | Catalog Part Number | ESR Max. @ 25 °C 120 Hz (mΩ) | Ripple Max. @ 85°C 120 Hz (A) | Nominal Size D x L (inches) |
|--------------------------------|---------------------|------------------------------|-------------------------------|-----------------------------|
| <b>350 Vdc (400 Vdc Surge)</b> |                     |                              |                               |                             |
| 770                            | 500C771T350EH2B     | 162.0                        | 3.50                          | 1 3/4 x 2 5/8               |
| 790                            | 500C791T350AJ2B     | 153.0                        | 3.50                          | 1 3/8 x 3 5/8               |
| 790                            | 500C791T350BA2B     | 168.0                        | 3.50                          | 2 x 2 1/8                   |
| 950                            | 500C951T350AC2B     | 127.0                        | 4.00                          | 1 3/8 x 4 1/8               |
| 970                            | 500C971T350BH2B     | 132.0                        | 4.20                          | 2 x 2 5/8                   |
| 990                            | 500C991T350EB2B     | 125.0                        | 4.30                          | 1 3/4 x 3 1/8               |
| 1100                           | 500C112T350AD2B     | 110.0                        | 4.50                          | 1 3/8 x 4 5/8               |
| 1300                           | 500C132T350AE2B     | 96.3                         | 5.00                          | 1 3/8 x 5 1/8               |
| 1300                           | 500C132T350EJ2B     | 97.3                         | 5.10                          | 1 3/4 x 3 5/8               |
| 1300                           | 500C132T350BB2B     | 101.0                        | 5.10                          | 2 x 3 1/8                   |
| 1400                           | 500C142T350AF2B     | 85.9                         | 5.50                          | 1 3/8 x 5 5/8               |
| 1500                           | 500C152T350CH2B     | 86.9                         | 6.00                          | 2 1/2 x 2 5/8               |
| 1600                           | 500C162T350EC2B     | 79.9                         | 5.90                          | 1 3/4 x 4 1/8               |
| 1600                           | 500C162T350BJ2B     | 79.2                         | 6.10                          | 2 x 3 5/8                   |
| 1800                           | 500C182T350ED2B     | 67.8                         | 6.60                          | 1 3/4 x 4 5/8               |
| 2000                           | 500C202T350BC2B     | 65.1                         | 7.00                          | 2 x 4 1/8                   |
| 2100                           | 500C212T350EE2B     | 59.1                         | 7.40                          | 1 3/4 x 5 1/8               |
| 2100                           | 500C212T350CB2B     | 61.0                         | 7.60                          | 2 1/2 x 3 1/8               |
| 2300                           | 500C232T350BD2B     | 55.4                         | 8.00                          | 2 x 4 5/8                   |
| 2400                           | 500C242T350EF2B     | 52.4                         | 8.10                          | 1 3/4 x 5 5/8               |
| 2700                           | 500C272T350BE2B     | 48.3                         | 8.80                          | 2 x 5 1/8                   |
| 2700                           | 500C272T350CJ2B     | 48.5                         | 8.90                          | 2 1/2 x 3 5/8               |
| 2900                           | 500C292T350DB2B     | 54.0                         | 9.00                          | 3 x 3 1/8                   |
| 3100                           | 500C312T350BF2B     | 42.8                         | 9.70                          | 2 x 5 5/8                   |
| 3300                           | 500C332T350CC2B     | 39.9                         | 10.30                         | 2 1/2 x 4 1/8               |
| 3700                           | 500C372T350DJ2B     | 41.7                         | 10.80                         | 3 x 3 5/8                   |
| 3900                           | 500C392T350CD2B     | 34.0                         | 11.60                         | 2 1/2 x 4 5/8               |
| 4500                           | 500C452T350CE2B     | 29.6                         | 12.80                         | 2 1/2 x 5 1/8               |
| 4600                           | 500C462T350DC2B     | 34.7                         | 12.30                         | 3 x 4 1/8                   |
| 5100                           | 500C512T350CF2B     | 26.2                         | 14.10                         | 2 1/2 x 5 5/8               |
| 5400                           | 500C542T350DD2B     | 29.6                         | 13.90                         | 3 x 4 5/8                   |
| 6200                           | 500C622T350DE2B     | 25.8                         | 15.30                         | 3 x 5 1/8                   |
| 6400                           | 500C642T350FC2D     | 29.9                         | 14.60                         | 3 1/2 x 4 1/8               |
| 7000                           | 500C702T350DF2B     | 22.9                         | 16.70                         | 3 x 5 5/8                   |
| 7500                           | 500C752T350DP2B     | 21.7                         | 17.40                         | 3 x 5 7/8                   |
| 7500                           | 500C752T350FD2D     | 25.7                         | 16.30                         | 3 1/2 x 4 5/8               |
| 8700                           | 500C872T350FE2D     | 22.5                         | 18.00                         | 3 1/2 x 5 1/8               |
| 9800                           | 500C982T350FF2D     | 20.0                         | 19.60                         | 3 1/2 x 5 5/8               |
| 10000                          | 500C103T350DN2B     | 17.1                         | 21.80                         | 3 x 7 5/8                   |
| 10000                          | 500C103T350FP2D     | 18.9                         | 20.40                         | 3 1/2 x 5 7/8               |
| 12000                          | 500C123T350DG2B     | 14.2                         | 24.30                         | 3 x 8 5/8                   |
| 15000                          | 500C153T350FN2D     | 14.9                         | 25.40                         | 3 1/2 x 7 5/8               |
| 17000                          | 500C173T350FG2D     | 12.4                         | 28.30                         | 3 1/2 x 8 5/8               |

# Type 500C 95 °C Long Life, Screw Terminal, Aluminum

## Long Life, High Capacitance Screw Terminal Type

| Cap. (µF)                      | Catalog Part Number | ESR Max. @ 25 °C 120 Hz (mΩ) | Ripple Max. @ 85°C 120 Hz (A) | Nominal Size D x L (inches) |
|--------------------------------|---------------------|------------------------------|-------------------------------|-----------------------------|
| <b>400 Vdc (450 Vdc Surge)</b> |                     |                              |                               |                             |
| 160                            | 500C161T400AK2B     | 652.0                        | 1.30                          | 1 3/8 x 1 5/8               |
| 250                            | 500C251T400AA2B     | 408.0                        | 1.80                          | 1 3/8 x 2 1/8               |
| 380                            | 500C381T400AH2B     | 273.0                        | 2.30                          | 1 3/8 x 2 5/8               |
| 500                            | 500C501T400AB2B     | 205.0                        | 2.90                          | 1 3/8 x 3 1/8               |
| 570                            | 500C571T400EA2B     | 189.0                        | 3.00                          | 1 3/4 x 2 1/8               |
| 610                            | 500C611T400EH2B     | 174.0                        | 3.40                          | 1 3/4 x 2 5/8               |
| 630                            | 500C631T400AJ2B     | 164.0                        | 3.40                          | 1 3/8 x 3 5/8               |
| 630                            | 500C631T400BA2B     | 179.0                        | 3.40                          | 2 x 2 1/8                   |
| 750                            | 500C751T400AC2B     | 137.0                        | 3.90                          | 1 3/8 x 4 1/8               |
| 780                            | 500C781T400BH2B     | 142.0                        | 4.10                          | 2 x 2 5/8                   |
| 790                            | 500C791T400EB2B     | 134.0                        | 4.10                          | 1 3/4 x 3 1/8               |
| 880                            | 500C881T400AD2B     | 118.0                        | 4.40                          | 1 3/8 x 4 5/8               |
| 1000                           | 500C102T400AE2B     | 104.0                        | 4.90                          | 1 3/8 x 5 1/8               |
| 1000                           | 500C102T400EJ2B     | 105.0                        | 4.90                          | 1 3/4 x 3 5/8               |
| 1000                           | 500C102T400BB2B     | 109.0                        | 5.00                          | 2 x 3 1/8                   |
| 1100                           | 500C112T400AF2B     | 92.4                         | 5.30                          | 1 3/8 x 5 5/8               |
| 1200                           | 500C122T400EC2B     | 85.8                         | 5.70                          | 1 3/4 x 4 1/8               |
| 1200                           | 500C122T400CH2B     | 93.1                         | 5.80                          | 2 1/2 x 2 5/8               |
| 1300                           | 500C132T400BJ2B     | 85.0                         | 5.90                          | 2 x 3 5/8                   |
| 1500                           | 500C152T400ED2B     | 72.9                         | 6.40                          | 1 3/4 x 4 5/8               |
| 1600                           | 500C162T400BC2B     | 69.8                         | 6.80                          | 2 x 4 1/8                   |
| 1700                           | 500C172T400EE2B     | 63.4                         | 7.10                          | 1 3/4 x 5 1/8               |
| 1700                           | 500C172T400CB2B     | 65.3                         | 7.30                          | 2 1/2 x 3 1/8               |
| 1900                           | 500C192T400EF2B     | 56.2                         | 7.80                          | 1 3/4 x 5 5/8               |
| 1900                           | 500C192T400BD2B     | 59.3                         | 7.70                          | 2 x 4 5/8                   |
| 2100                           | 500C212T400BE2B     | 51.7                         | 8.50                          | 2 x 5 1/8                   |
| 2100                           | 500C212T400CJ2B     | 52.0                         | 8.60                          | 2 1/2 x 3 5/8               |
| 2300                           | 500C232T400DB2B     | 57.5                         | 8.80                          | 3 x 3 1/8                   |
| 2400                           | 500C242T400BF2B     | 45.9                         | 9.30                          | 2 x 5 5/8                   |
| 2600                           | 500C262T400CC2B     | 42.8                         | 9.90                          | 2 1/2 x 4 1/8               |
| 3000                           | 500C302T400DJ2B     | 44.9                         | 10.40                         | 3 x 3 5/8                   |
| 3100                           | 500C312T400CD2B     | 35.6                         | 11.30                         | 2 1/2 x 4 5/8               |
| 3500                           | 500C352T400CE2B     | 31.7                         | 12.40                         | 2 1/2 x 5 1/8               |
| 3600                           | 500C362T400DC2B     | 37.0                         | 11.90                         | 3 x 4 1/8                   |
| 4000                           | 500C402T400CF2B     | 31.5                         | 12.80                         | 2 1/2 x 5 5/8               |
| 4300                           | 500C432T400DD2B     | 28.1                         | 14.20                         | 3 x 4 5/8                   |
| 4900                           | 500C492T400DE2B     | 27.4                         | 14.80                         | 3 x 5 1/8                   |
| 5100                           | 500C512T400FC2D     | 31.9                         | 14.10                         | 3 1/2 x 4 1/8               |
| 5600                           | 500C562T400DF2B     | 24.4                         | 16.20                         | 3 x 5 5/8                   |
| 5900                           | 500C592T400DP2B     | 23.1                         | 16.90                         | 3 x 5 7/8                   |
| 6000                           | 500C602T400FD2D     | 27.4                         | 15.80                         | 3 1/2 x 4 5/8               |
| 6900                           | 500C692T400FE2D     | 23.9                         | 17.50                         | 3 1/2 x 5 1/8               |
| 7800                           | 500C782T400FF2D     | 21.2                         | 19.00                         | 3 1/2 x 5 5/8               |

| Cap. (µF)                      | Catalog Part Number | ESR Max. @ 25 °C 120 Hz (mΩ) | Ripple Max. @ 85°C 120 Hz (A) | Nominal Size D x L (inches) |
|--------------------------------|---------------------|------------------------------|-------------------------------|-----------------------------|
| 8200                           | 500C822T400DN2B     | 18.2                         | 21.20                         | 3 x 7 5/8                   |
| 8300                           | 500C832T400FP2D     | 20.1                         | 19.80                         | 3 1/2 x 5 7/8               |
| 9500                           | 500C952T400DG2B     | 15.1                         | 23.60                         | 3 x 8 5/8                   |
| 11000                          | 500C113T400FN2D     | 15.8                         | 24.70                         | 3 1/2 x 7 5/8               |
| 13000                          | 500C133T400FG2D     | 13.1                         | 27.50                         | 3 1/2 x 8 5/8               |
| <b>450 Vdc (500 Vdc Surge)</b> |                     |                              |                               |                             |
| 140                            | 500C141T450AK2B     | 797.0                        | 1.10                          | 1 3/8 x 1 5/8               |
| 220                            | 500C221T450AA2B     | 438.0                        | 1.70                          | 1 3/8 x 2 1/8               |
| 330                            | 500C331T450AH2B     | 337.0                        | 2.10                          | 1 3/8 x 2 5/8               |
| 420                            | 500C421T450EA2B     | 264.0                        | 2.60                          | 1 3/4 x 2 1/8               |
| 440                            | 500C441T450AB2B     | 253.0                        | 2.60                          | 1 3/8 x 3 1/8               |
| 520                            | 500C521T450EH2B     | 213.0                        | 3.10                          | 1 3/4 x 2 5/8               |
| 550                            | 500C551T450AJ2B     | 203.0                        | 3.10                          | 1 3/8 x 3 5/8               |
| 550                            | 500C551T450BA2B     | 228.0                        | 3.00                          | 2 x 2 1/8                   |
| 660                            | 500C661T450AC2B     | 169.0                        | 3.50                          | 1 3/8 x 4 1/8               |
| 670                            | 500C671T450EB2B     | 165.0                        | 3.70                          | 1 3/4 x 3 1/8               |
| 680                            | 500C681T450BH2B     | 178.0                        | 3.60                          | 2 x 2 5/8                   |
| 760                            | 500C761T450AD2B     | 146.0                        | 3.90                          | 1 3/8 x 4 5/8               |
| 870                            | 500C871T450AE2B     | 128.0                        | 4.40                          | 1 3/8 x 5 1/8               |
| 870                            | 500C871T450EJ2B     | 131.0                        | 4.40                          | 1 3/4 x 3 5/8               |
| 870                            | 500C871T450BB2B     | 137.0                        | 4.40                          | 2 x 3 1/8                   |
| 980                            | 500C981T450AF2B     | 114.0                        | 4.80                          | 1 3/8 x 5 5/8               |
| 1100                           | 500C112T450EC2B     | 107.0                        | 5.10                          | 1 3/4 x 4 1/8               |
| 1100                           | 500C112T450BJ2B     | 109.0                        | 5.20                          | 2 x 3 5/8                   |
| 1100                           | 500C112T450CH2B     | 116.0                        | 5.20                          | 2 1/2 x 2 5/8               |
| 1300                           | 500C132T450ED2B     | 91.1                         | 5.70                          | 1 3/4 x 4 5/8               |
| 1400                           | 500C142T450EE2B     | 79.2                         | 6.40                          | 1 3/4 x 5 1/8               |
| 1400                           | 500C142T450BC2B     | 89.5                         | 6.00                          | 2 x 4 1/8                   |
| 1500                           | 500C152T450CB2B     | 81.1                         | 6.60                          | 2 1/2 x 3 1/8               |
| 1600                           | 500C162T450EF2B     | 70.2                         | 7.00                          | 1 3/4 x 5 5/8               |
| 1600                           | 500C162T450BD2B     | 76.0                         | 6.80                          | 2 x 4 5/8                   |
| 1900                           | 500C192T450BE2B     | 66.1                         | 7.50                          | 2 x 5 1/8                   |
| 1900                           | 500C192T450CJ2B     | 66.5                         | 7.60                          | 2 1/2 x 3 5/8               |
| 2100                           | 500C212T450BF2B     | 58.6                         | 8.30                          | 2 x 5 5/8                   |
| 2100                           | 500C212T450DB2B     | 63.8                         | 8.30                          | 3 x 3 1/8                   |
| 2400                           | 500C242T450CC2B     | 54.7                         | 8.80                          | 2 1/2 x 4 1/8               |
| 2700                           | 500C272T450DJ2B     | 49.8                         | 9.90                          | 3 x 3 5/8                   |
| 2800                           | 500C282T450CD2B     | 46.4                         | 9.90                          | 2 1/2 x 4 5/8               |
| 3200                           | 500C322T450CE2B     | 40.4                         | 11.00                         | 2 1/2 x 5 1/8               |
| 3300                           | 500C332T450DC2B     | 38.2                         | 11.80                         | 3 x 4 1/8                   |
| 3600                           | 500C362T450CF2B     | 35.4                         | 12.10                         | 2 1/2 x 5 5/8               |
| 3900                           | 500C392T450DD2B     | 35.7                         | 12.60                         | 3 x 4 5/8                   |
| 4500                           | 500C452T450DE2B     | 30.9                         | 14.00                         | 3 x 5 1/8                   |
| 4600                           | 500C462T450FC2D     | 30.3                         | 14.50                         | 3 1/2 x 4 1/8               |

# Type 500C 95 °C Long Life, Screw Terminal, Aluminum

## Long Life, High Capacitance Screw Terminal Type

| Cap. (µF)                      | Catalog Part Number | ESR Max. @ 25 °C 120 Hz (mΩ) | Ripple Max. @ 85°C 120 Hz (A) | Nominal Size D x L (inches) |
|--------------------------------|---------------------|------------------------------|-------------------------------|-----------------------------|
| <b>450 Vdc (500 Vdc Surge)</b> |                     |                              |                               |                             |
| 5100                           | 500C512T450DF2B     | 27.4                         | 15.30                         | 3 x 5 5/8                   |
| 5400                           | 500C542T450DP2B     | 26.0                         | 15.90                         | 3 x 5 7/8                   |
| 5400                           | 500C542T450FD2D     | 25.7                         | 16.30                         | 3 1/2 x 4 5/8               |
| 6300                           | 500C632T450FE2D     | 22.4                         | 18.00                         | 3 1/2 x 5 1/8               |
| 7100                           | 500C712T450FF2D     | 19.9                         | 19.70                         | 3 1/2 x 5 5/8               |
| 7500                           | 500C752T450FP2D     | 18.8                         | 20.50                         | 3 1/2 x 5 7/8               |
| 7500                           | 500C752T450DN2B     | 20.3                         | 20.00                         | 3 x 7 5/8                   |
| 8700                           | 500C872T450DG2B     | 16.8                         | 22.40                         | 3 x 8 5/8                   |
| 9700                           | 500C972T450FN2D     | 15.1                         | 25.20                         | 3 1/2 x 7 5/8               |
| 11000                          | 500C113T450FG2D     | 12.7                         | 28.00                         | 3 1/2 x 8 5/8               |
| <b>500 Vdc (550 Vdc Surge)</b> |                     |                              |                               |                             |
| 100                            | 500C101T500AK2B     | 1224.0                       | 0.90                          | 1 3/8 x 1 5/8               |
| 170                            | 500C171T500AA2B     | 722.0                        | 1.30                          | 1 3/8 x 2 1/8               |
| 230                            | 500C231T500AH2B     | 546.0                        | 1.70                          | 1 3/8 x 2 5/8               |
| 260                            | 500C261T500EA2B     | 498.0                        | 1.90                          | 1 3/4 x 2 1/8               |
| 310                            | 500C311T500AB2B     | 410.0                        | 2.00                          | 1 3/8 x 3 1/8               |
| 320                            | 500C321T500BA2B     | 393.0                        | 2.30                          | 2 x 2 1/8                   |
| 370                            | 500C371T500EH2B     | 347.0                        | 2.40                          | 1 3/4 x 2 5/8               |
| 380                            | 500C381T500AJ2B     | 328.0                        | 2.40                          | 1 3/8 x 3 5/8               |
| 460                            | 500C461T500AC2B     | 293.0                        | 2.70                          | 1 3/8 x 4 1/8               |
| 470                            | 500C471T500BH2B     | 274.0                        | 2.90                          | 2 x 2 5/8                   |
| 480                            | 500C481T500EB2B     | 265.0                        | 2.90                          | 1 3/4 x 3 1/8               |
| 530                            | 500C531T500AD2B     | 261.0                        | 2.90                          | 1 3/8 x 4 5/8               |
| 610                            | 500C611T500AE2B     | 231.0                        | 3.30                          | 1 3/8 x 5 1/8               |
| 620                            | 500C621T500EJ2B     | 202.0                        | 3.50                          | 1 3/4 x 3 5/8               |
| 650                            | 500C651T500BB2B     | 200.0                        | 3.70                          | 2 x 3 1/8                   |
| 690                            | 500C691T500AF2B     | 195.0                        | 3.70                          | 1 3/8 x 5 5/8               |
| 760                            | 500C761T500EC2B     | 169.0                        | 4.00                          | 1 3/4 x 4 1/8               |
| 770                            | 500C771T500CH2B     | 171.0                        | 4.30                          | 2 1/2 x 2 5/8               |
| 840                            | 500C841T500BJ2B     | 156.0                        | 4.40                          | 2 x 3 5/8                   |
| 890                            | 500C891T500ED2B     | 143.0                        | 4.60                          | 1 3/4 x 4 5/8               |
| 960                            | 500C961T500BC2B     | 136.0                        | 4.90                          | 2 x 4 1/8                   |
| 1000                           | 500C102T500EE2B     | 125.0                        | 5.10                          | 1 3/4 x 5 1/8               |
| 1100                           | 500C112T500BD2B     | 115.0                        | 5.50                          | 2 x 4 5/8                   |
| 1100                           | 500C112T500CB2B     | 122.0                        | 5.40                          | 2 1/2 x 3 1/8               |

| Cap. (µF)                      | Catalog Part Number | ESR Max. @ 25 °C 120 Hz (mΩ) | Ripple Max. @ 85°C 120 Hz (A) | Nominal Size D x L (inches) |
|--------------------------------|---------------------|------------------------------|-------------------------------|-----------------------------|
| <b>500 Vdc (550 Vdc Surge)</b> |                     |                              |                               |                             |
| 1200                           | 500C122T500EF2B     | 110.0                        | 5.60                          | 1 3/4 x 5 5/8               |
| 1300                           | 500C132T500BE2B     | 100.0                        | 6.10                          | 2 x 5 1/8                   |
| 1400                           | 500C142T500CJ2B     | 95.1                         | 6.40                          | 2 1/2 x 3 5/8               |
| 1500                           | 500C152T500BF2B     | 88.9                         | 6.70                          | 2 x 5 5/8                   |
| 1600                           | 500C162T500DB2B     | 86.4                         | 7.10                          | 3 x 3 1/8                   |
| 1700                           | 500C172T500CC2B     | 78.1                         | 7.40                          | 2 1/2 x 4 1/8               |
| 2000                           | 500C202T500CD2B     | 66.3                         | 8.30                          | 2 1/2 x 4 5/8               |
| 2100                           | 500C212T500DJ2B     | 67.4                         | 8.50                          | 3 x 3 5/8                   |
| 2200                           | 500C222T500CE2B     | 61.1                         | 8.90                          | 2 1/2 x 5 1/8               |
| 2400                           | 500C242T500CF2B     | 54.7                         | 9.70                          | 2 1/2 x 5 5/8               |
| 2400                           | 500C242T500DC2B     | 55.4                         | 9.80                          | 3 x 4 1/8                   |
| 2800                           | 500C282T500DD2B     | 48.1                         | 10.90                         | 3 x 4 5/8                   |
| 3300                           | 500C332T500DE2B     | 43.1                         | 11.80                         | 3 x 5 1/8                   |
| 3400                           | 500C342T500FC2D     | 40.1                         | 12.60                         | 3 1/2 x 4 1/8               |
| 3700                           | 500C372T500DF2B     | 37.5                         | 13.10                         | 3 x 5 5/8                   |
| 3900                           | 500C392T500DP2B     | 35.5                         | 13.60                         | 3 x 5 7/8                   |
| 4000                           | 500C402T500FD2D     | 34.1                         | 14.20                         | 3 1/2 x 4 5/8               |
| 4600                           | 500C462T500FE2D     | 30.0                         | 15.60                         | 3 1/2 x 5 1/8               |
| 5200                           | 500C522T500FF2D     | 28.0                         | 16.60                         | 3 1/2 x 5 5/8               |
| 5400                           | 500C542T500DN2B     | 27.9                         | 17.10                         | 3 x 7 5/8                   |
| 5500                           | 500C552T500FP2D     | 26.0                         | 17.40                         | 3 1/2 x 5 7/8               |
| 6300                           | 500C632T500DG2B     | 23.1                         | 19.10                         | 3 x 8 5/8                   |
| 7600                           | 500C762T500FN2D     | 20.5                         | 21.80                         | 3 1/2 x 7 5/8               |
| 8800                           | 500C882T500FG2D     | 16.7                         | 24.40                         | 3 1/2 x 8 5/8               |
| <b>550 Vdc (600 Vdc Surge)</b> |                     |                              |                               |                             |
| 1400                           | 500C142T550CC2B     | 170.5                        | 4.90                          | 2 1/2 x 4 1/8               |
| 1700                           | 500C172T550CD2B     | 132.6                        | 5.90                          | 2 1/2 x 4 5/8               |
| 1900                           | 500C192T550CE2B     | 111.7                        | 6.80                          | 2 1/2 x 5.125               |
| 2200                           | 500C222T550DC2B     | 90.4                         | 7.80                          | 3 x 4 1/8                   |
| 2300                           | 500C232T550CF2B     | 86.5                         | 7.80                          | 2 1/2 x 5 5/8               |
| 2500                           | 500C252T550DD2B     | 79.6                         | 8.40                          | 3 x 4 5/8                   |
| 2900                           | 500C292T550DE2B     | 64.0                         | 9.70                          | 3 x 5 1/8                   |
| 3400                           | 500C342T550DF2F     | 54.6                         | 10.90                         | 3 x 5 5/8                   |
| 3700                           | 500C372T550DP2B     | 50.2                         | 12.24                         | 3 x 5 7/8                   |
| 5100                           | 500C512T550DN2B     | 36.4                         | 16.22                         | 3 x 7 5/8                   |

# Type 500C 95 °C Long Life, Screw Terminal, Aluminum

## Long Life, High Capacitance Screw Terminal Type

### Typical Performance Curves

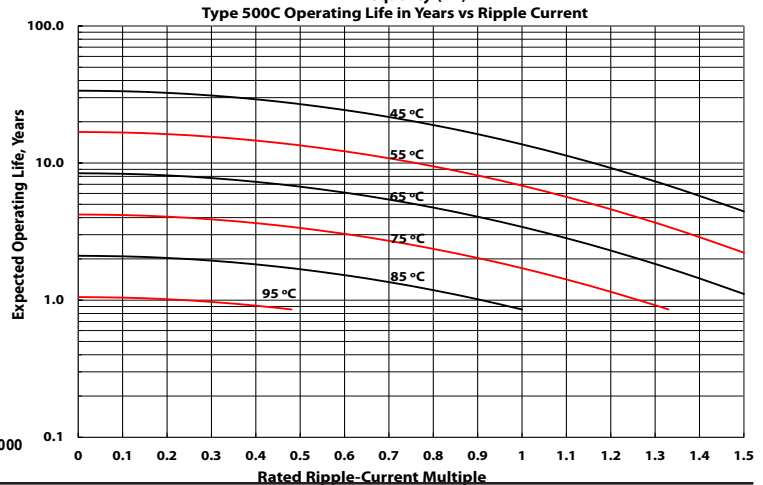
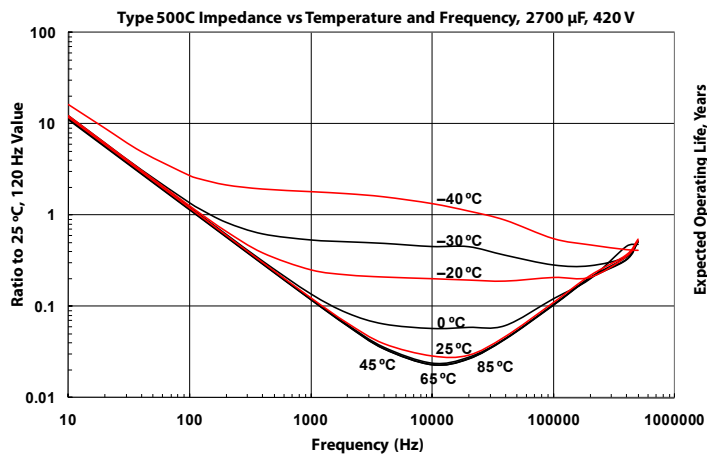
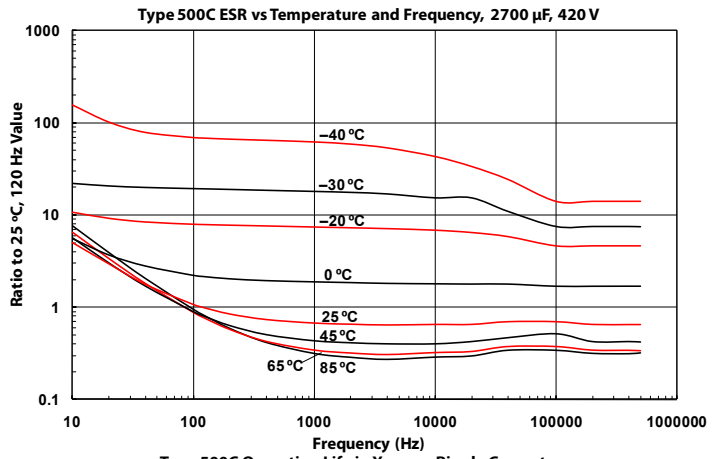
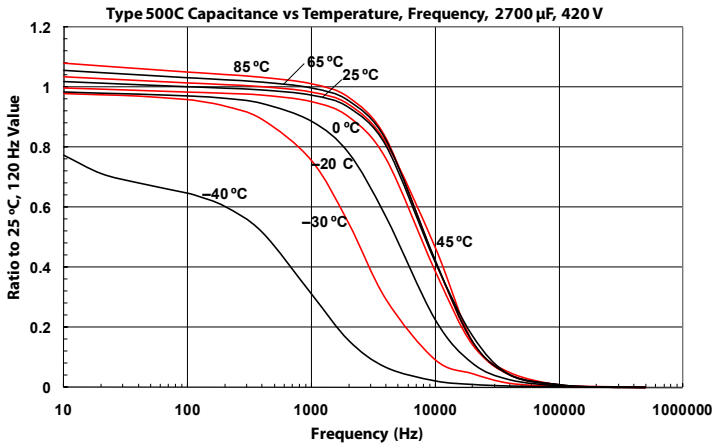
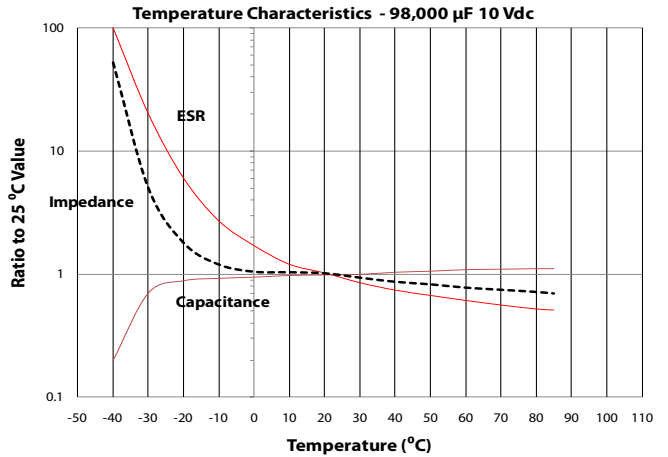
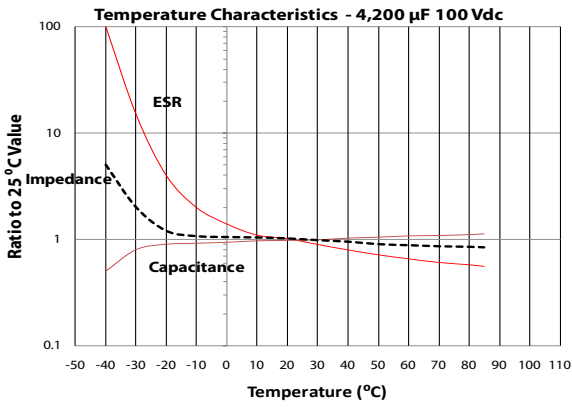
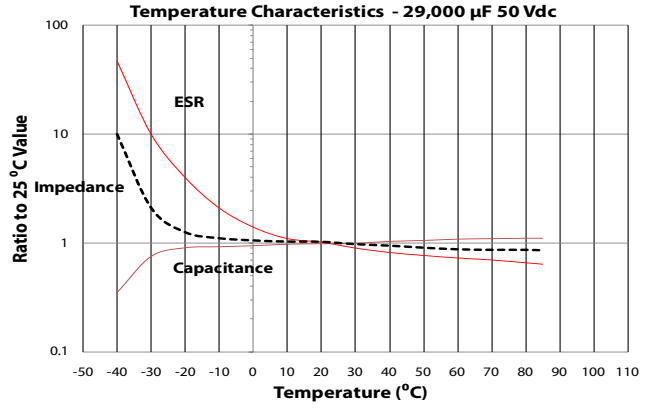
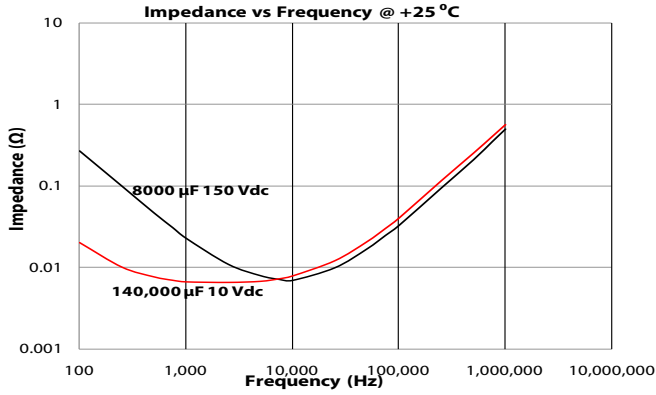



Компания «ЭлектроПласт» предлагает заключение долгосрочных отношений при поставках импортных электронных компонентов на взаимовыгодных условиях!

Наши преимущества:

- Оперативные поставки широкого спектра электронных компонентов отечественного и импортного производства напрямую от производителей и с крупнейших мировых складов;
- Поставка более 17-ти миллионов наименований электронных компонентов;
- Поставка сложных, дефицитных, либо снятых с производства позиций;
- Оперативные сроки поставки под заказ (от 5 рабочих дней);
- Экспресс доставка в любую точку России;
- Техническая поддержка проекта, помощь в подборе аналогов, поставка прототипов;
- Система менеджмента качества сертифицирована по Международному стандарту ISO 9001;
- Лицензия ФСБ на осуществление работ с использованием сведений, составляющих государственную тайну;
- Поставка специализированных компонентов (Xilinx, Altera, Analog Devices, Intersil, Interpoint, Microsemi, Aeroflex, Peregrine, Syfer, Eurofarad, Texas Instrument, Miteq, Cobham, E2V, MA-COM, Hittite, Mini-Circuits, General Dynamics и др.);

Помимо этого, одним из направлений компании «ЭлектроПласт» является направление «Источники питания». Мы предлагаем Вам помощь Конструкторского отдела:

- Подбор оптимального решения, техническое обоснование при выборе компонента;
- Подбор аналогов;
- Консультации по применению компонента;
- Поставка образцов и прототипов;
- Техническая поддержка проекта;
- Защита от снятия компонента с производства.



#### Как с нами связаться

**Телефон:** 8 (812) 309 58 32 (многоканальный)

**Факс:** 8 (812) 320-02-42

**Электронная почта:** [org@eplast1.ru](mailto:org@eplast1.ru)

**Адрес:** 198099, г. Санкт-Петербург, ул. Калинина, дом 2, корпус 4, литера А.