LOW NOISE 150mA LDO REGULATOR

NO.EA-094-0512

OUTLINE

The R1114x Series are CMOS-based voltage regulator ICs with high output voltage accuracy, low supply current, low ON-resistance, and high ripple rejection. Each of these ICs consists of a voltage reference unit, an error amplifier, resistor-net for voltage setting, a current limit circuit, and a chip enable circuit.

These ICs perform with low dropout voltage and a chip enable function. The line transient response and load transient response of the R1114x Series are excellent, thus these ICs are very suitable for the power supply for hand-held communication equipment.

The output voltage of these ICs is fixed with high accuracy. Since the packages for these ICs are SOT-23-5, SC-82AB, and SON1612-6 therefore high density mounting of the ICs on boards is possible.

FEATURES

- Low Supply Current Typ. 75 μ A
- Standby Mode Typ. 0.1 μ A
- Low Dropout Voltage..... Typ. 0.22V ($I_{OUT}=150\text{mA}$ 3.0V Output type)
- High Ripple Rejection Typ. 70dB ($f=1\text{kHz}$ 3.0V Output type)
..... Typ. 60dB ($f=10\text{kHz}$)
- Low Temperature-Drift Coefficient of Output Voltage..... Typ. $\pm 100\text{ppm}/^\circ\text{C}$
- Excellent Line Regulation Typ. 0.02%/V
- High Output Voltage Accuracy $\pm 2.0\%$
- Small Packages SOT-23-5/SC-82AB/SON1612-6
- Output Voltage Stepwise setting with a step of 0.1V in
the range of 1.5V to 4.0V is possible
- Built-in Fold Back Protection Circuit Typ. 40mA (Current at short mode)
- Ceramic capacitors are recommended to be used with this IC ... $C_{IN}=C_{OUT}=1\mu\text{F}$ ($V_{OUT}<2.5\text{V}$)
 $C_{IN}=1\mu\text{F}$, $C_{OUT}=0.47\mu\text{F}$ ($V_{OUT} \geq 2.5\text{V}$)

APPLICATIONS

- Power source for portable communication equipment.
- Power source for electrical appliances such as cameras, VCRs and camcorders.
- Power source for battery-powered equipment.

BLOCK DIAGRAMS



SELECTION GUIDE

The output voltage, version, and the taping type for the ICs can be selected at the user's request.
The selection can be made with designating the part number as shown below;

R1114xxx1x-xx ←Part Number
 ↑ ↑ ↑ ↑
 a b c d

| Code | Contents |
|------|---|
| a | Designation of Package Type: N: SOT-23-5 D: SON1612-6 Q: SC-82AB |
| b | Setting Output Voltage (V_{OUT}): Stepwise setting with a step of 0.1V in the range of 1.5V to 4.0V is possible. |
| c | Designation of Active Type: A: active low type B: active high type D: active high, with auto discharge |
| d | Designation of Taping Type: Ex. TR (refer to Taping Specifications; TR type is the standard direction.) |

PIN CONFIGURATION



PIN DESCRIPTIONS

• R1114Q

| Pin No. | Symbol | Description |
|---------|-----------------------|-----------------|
| 1 | \overline{CE} or CE | Chip Enable Pin |
| 2 | GND | Ground Pin |
| 3 | V_{OUT} | Output pin |
| 4 | V_{DD} | Input Pin |

• R1114N

| Pin No. | Symbol | Description |
|---------|-----------------------|-----------------|
| 1 | V_{DD} | Input Pin |
| 2 | GND | Ground Pin |
| 3 | \overline{CE} or CE | Chip Enable Pin |
| 4 | NC | No Connection |
| 5 | V_{OUT} | Output pin |

• R1114D

| Pin No. | Symbol | Description |
|---------|-----------------------|-----------------|
| 1 | V_{DD} | Input Pin |
| 2 | GND | Ground Pin |
| 3 | V_{OUT} | Output pin |
| 4 | NC | No Connection |
| 5 | GND | Ground Pin |
| 6 | \overline{CE} or CE | Chip Enable Pin |

ABSOLUTE MAXIMUM RATINGS

| Symbol | Item | Rating | Unit |
|-----------|--|--------------------------|-------------|
| V_{IN} | Input Voltage | 6.5 | V |
| V_{CE} | Input Voltage (\overline{CE} or CE Pin) | 6.5 | V |
| V_{OUT} | Output Voltage | $-0.3 \sim V_{IN} + 0.3$ | V |
| I_{OUT} | Output Current | 200 | mA |
| P_D | Power Dissipation (SOT-23-5) *1 | 420 | mW |
| | Power Dissipation (SC82-AB) *1 | 380 | |
| | Power Dissipation (SON1612-6) *1 | 500 | |
| T_{opt} | Operating Temperature Range | $-40 \sim 85$ | $^{\circ}C$ |
| T_{stg} | Storage Temperature Range | $-55 \sim 125$ | $^{\circ}C$ |

*1 For Power Dissipation, please refer to PACKAGE INFORMATION to be described.

ELECTRICAL CHARACTERISTICS

• R1114xxx1A

T_{opt}=25°C

| Symbol | Item | Conditions | Min. | Typ. | Max. | Unit |
|--------------------------------------|--|---|--------|----------|--------|--------|
| V _{OUT} | Output Voltage | V _{IN} = Set V _{OUT} +1V 1mA ≤ I _{OUT} ≤ 30mA | ×0.980 | | ×1.020 | V |
| I _{OUT} | Output Current | V _{IN} -V _{OUT} = 1.0V | 150 | | | mA |
| ΔV _{OUT} /ΔI _{OUT} | Load Regulation | V _{IN} = Set V _{OUT} +1V 1mA ≤ I _{OUT} ≤ 150mA | | 22 | 40 | mV |
| V _{DIF} | Dropout Voltage | Refer to the ELECTRICAL CHARACTERISTICS by OUTPUT VOLTAGE | | | | |
| I _{SS} | Supply Current | V _{IN} = Set V _{OUT} +1V, I _{OUT} = 0mA | | 75 | 95 | μA |
| I _{standby} | Supply Current (Standby) | V _{IN} = Set V _{OUT} +1V V _{CE} = V _{DD} | | 0.1 | 1.0 | μA |
| ΔV _{OUT} /ΔV _{IN} | Line Regulation | V _{OUT} > 1.7V, Set V _{OUT} +0.5V ≤ V _{IN} ≤ 6.0V (V _{OUT} ≤ 1.7V, 2.2V ≤ V _{IN} ≤ 6.0V) I _{OUT} = 30mA | | 0.02 | 0.10 | %/V |
| RR | Ripple Rejection | f=1kHz f=10kHz Ripple 0.5Vp-p V _{OUT} > 1.7V, V _{IN} -V _{OUT} = 1.0V V _{OUT} ≤ 1.7, V _{IN} -V _{OUT} = 1.2V I _{OUT} = 30mA | | 70 60 | | dB |
| V _{IN} | Input Voltage | | 2.0 | | 6.0 | V |
| ΔV _{OUT} /ΔT _{opt} | Output Voltage Temperature Coefficient | I _{OUT} = 30mA -40°C ≤ T _{opt} ≤ 85°C | | ±100 | | ppm/°C |
| I _{lim} | Short Current Limit | V _{OUT} = 0V | | 40 | | mA |
| R _{PU} | \overline{CE} Pull-up Resistance | | 0.7 | 2.0 | 8.0 | MΩ |
| V _{CEH} | \overline{CE} Input Voltage "H" | | 1.5 | | 6.0 | V |
| V _{CEL} | \overline{CE} Input Voltage "L" | | 0.0 | | 0.3 | V |
| en | Output Noise | BW = 10Hz to 100kHz | | 30 | | μVrms |

• R1114xxx1B/D

T_{opt}=25°C

| Symbol | Item | Conditions | Min. | Typ. | Max. | Unit |
|--------------------------------------|--|---|--------|----------|--------|--------|
| V _{OUT} | Output Voltage | V _{IN} = Set V _{OUT} +1V 1mA ≤ I _{OUT} ≤ 30mA | ×0.980 | | ×1.020 | V |
| I _{OUT} | Output Current | V _{IN} -V _{OUT} = 1.0V | 150 | | | mA |
| ΔV _{OUT} /ΔI _{OUT} | Load Regulation | V _{IN} = Set V _{OUT} +1V 1mA ≤ I _{OUT} ≤ 150mA | | 22 | 40 | mV |
| V _{DIF} | Dropout Voltage | Refer to the ELECTRICAL CHARACTERISTICS by OUTPUT VOLTAGE | | | | |
| I _{SS} | Supply Current | V _{IN} = Set V _{OUT} +1V, I _{OUT} = 0mA | | 75 | 95 | μA |
| I _{standby} | Supply Current (Standby) | V _{IN} = Set V _{OUT} +1V V _{CE} = GND | | 0.1 | 1.0 | μA |
| ΔV _{OUT} /ΔV _{IN} | Line Regulation | V _{OUT} > 1.7V, Set V _{OUT} +0.5V ≤ V _{IN} ≤ 6.0V (V _{OUT} ≤ 1.7V, 2.2V ≤ V _{IN} ≤ 6.0V) I _{OUT} = 30mA | | 0.02 | 0.10 | %/V |
| RR | Ripple Rejection | f=1kHz f=10kHz Ripple 0.5Vp-p V _{OUT} > 1.7V, V _{IN} -V _{OUT} = 1.0V V _{OUT} ≤ 1.7, V _{IN} -V _{OUT} = 1.2V I _{OUT} = 30mA | | 70 60 | | dB |
| V _{IN} | Input Voltage | | 2.0 | | 6.0 | V |
| ΔV _{OUT} /ΔT | Output Voltage Temperature Coefficient | I _{OUT} = 30mA -40°C ≤ T _{opt} ≤ 85°C | | ±100 | | ppm/°C |
| I _{LIM} | Short Current Limit | V _{OUT} = 0V | | 40 | | mA |
| R _{PD} | CE Pull-down Resistance | | 0.7 | 2.0 | 8.0 | MΩ |
| V _{CEH} | CE Input Voltage "H" | | 1.5 | | 6.0 | V |
| V _{CEL} | CE Input Voltage "L" | | 0.0 | | 0.3 | V |
| en | Output Noise | BW = 10Hz to 100kHz | | 30 | | μVrms |
| R _{LOW} | On Resistance of Nch for auto-discharge (Only for D version) | V _{CE} = 0V | | 60 | | Ω |

• ELECTRICAL CHARACTERISTICS by OUTPUT VOLTAGE

$T_{opt} = 25^{\circ}\text{C}$

| Output Voltage V_{OUT} (V) | Dropout Voltage | | |
|------------------------------|--------------------------|------|------|
| | V_{DIF} (V) | | |
| | Condition | Typ. | Max. |
| $V_{OUT} = 1.5$ | $I_{OUT} = 150\text{mA}$ | 0.38 | 0.70 |
| $V_{OUT} = 1.6$ | | 0.36 | 0.65 |
| $V_{OUT} = 1.7$ | | 0.34 | 0.60 |
| $1.8 \leq V_{OUT} \leq 2.0$ | | 0.32 | 0.55 |
| $2.1 \leq V_{OUT} \leq 2.7$ | | 0.28 | 0.50 |
| $2.8 \leq V_{OUT} \leq 4.0$ | | 0.22 | 0.35 |

TECHNICAL NOTES

When using these ICs, consider the following points:

Phase Compensation

In these ICs, phase compensation is made for securing stable operation even if the load current is varied. For this purpose, use a capacitor C_{OUT} with good frequency characteristics and ESR (Equivalent Series Resistance). (Note: If additional ceramic capacitors are connected with parallel to the output pin with an output capacitor for phase compensation, the operation might be unstable. Because of this, test these ICs with as same external components as ones to be used on the PCB.)

PCB Layout

Make V_{DD} and GND lines sufficient. If their impedance is high, noise pickup or unstable operation may result. Connect a capacitor with a capacitance value as much as $1.0\mu\text{F}$ or more between V_{DD} and GND pin, and as close as possible to the pins.

Set external components, especially the output capacitor, as close as possible to the ICs, and make wiring as short as possible.

TEST CIRCUITS



Fig.1 Standard test Circuit



Fig.2 Supply Current Test Circuit



Fig.3 Ripple Rejection, Line Transient Response Test Circuit



Fig.4 Load Transient Response Test Circuit

TYPICAL APPLICATIONS



(External Components)

Output Capacitor; Ceramic 0.47 μ F (Set Output Voltage in the range from 2.5 to 4.0V)

Ceramic 1.0 μ F (Set Output Voltage in the range from 1.5 to 2.4V)

Input Capacitor; Ceramic 1.0 μ F

TYPICAL CHARACTERISTICS

1) Output Voltage vs. Output Current (Topt=25°C)



2) Output Voltage vs. Input Voltage ($T_{opt}=25^{\circ}\text{C}$)3) Supply Current vs. Input Voltage ($T_{opt}=25^{\circ}\text{C}$)

R1114x401x



4) Output Voltage vs. Temperature

R1114x151x



R1114x281x

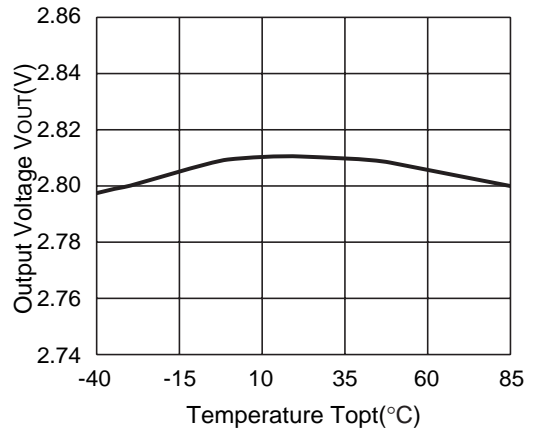

R1114x401x

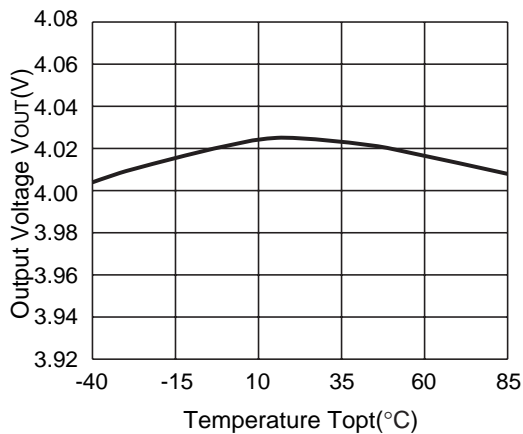

5) Supply Current vs. Temperature



6) Dropout Voltage vs. Temperature

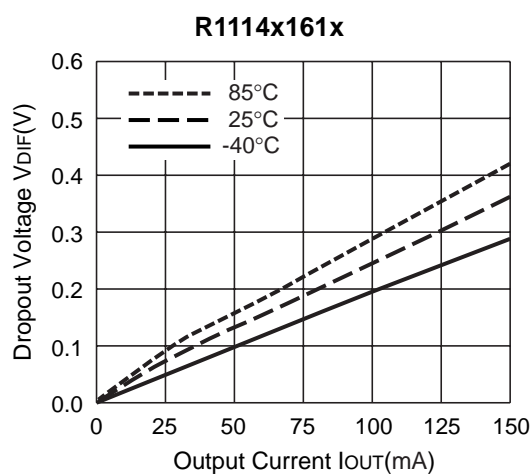
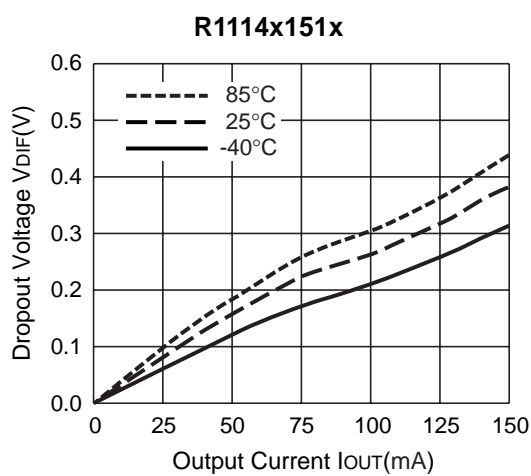

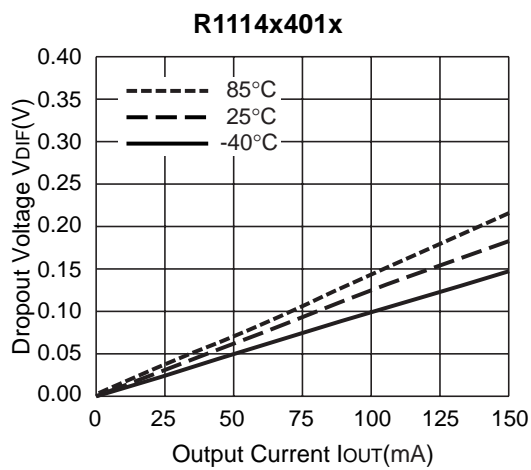
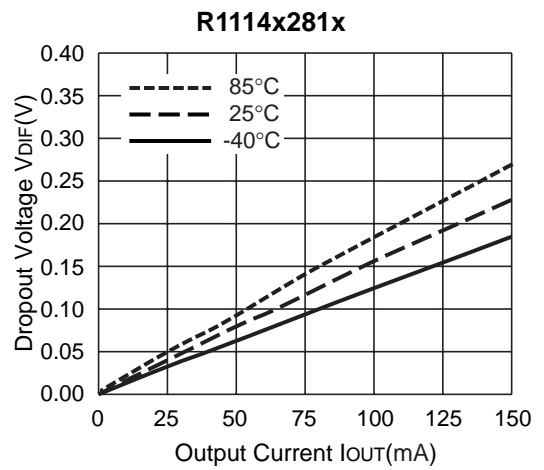
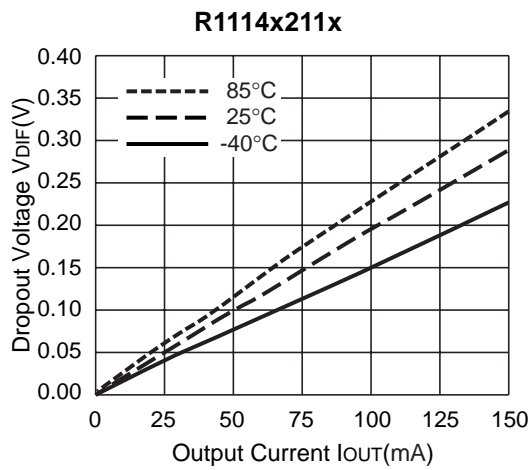
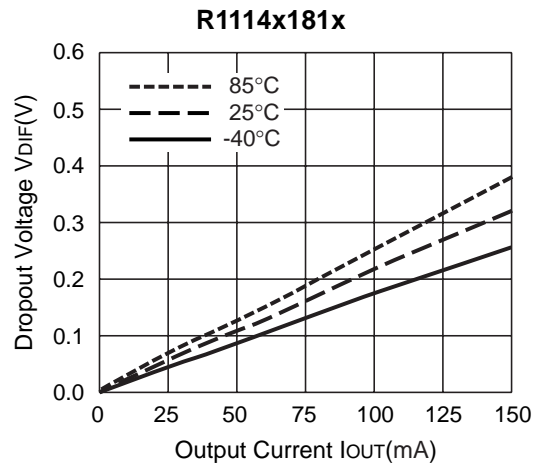
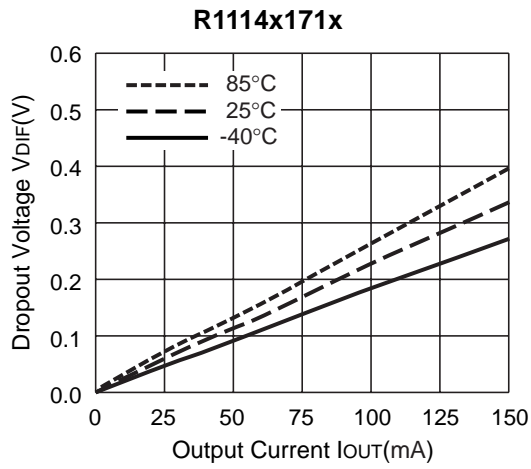

7) Dropout Voltage vs. Set Output Voltage (Topt=25°C)



8) Ripple Rejection vs. Input Bias Voltage (Topt=25°C, C_{IN}=none, C_{OUT}=ceramic0.47μF)

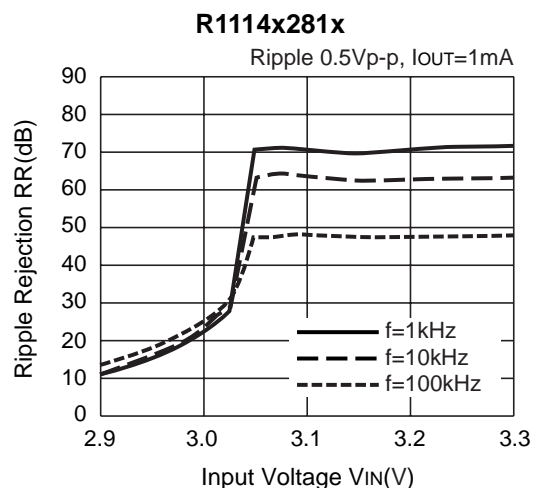
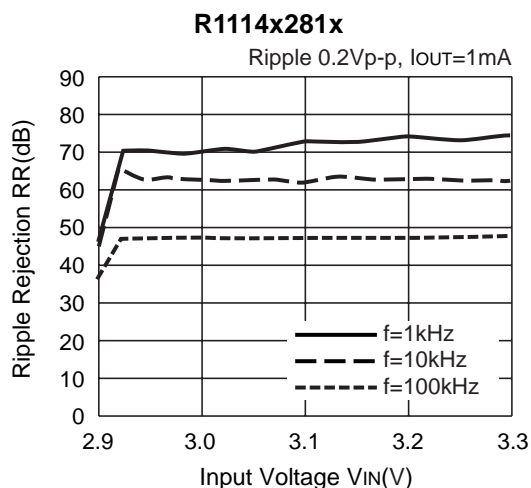



9) Ripple Rejection vs. Frequency (C_{IN}=none)





10) Input Transient Response ($I_{OUT}=30\text{mA}$, $C_{IN}=\text{none}$, $t_r=t_f=5\mu s$, $C_{OUT}=\text{Ceramic } 0.47\mu F$)



11) Load Transient Response ($t_r=t_f=0.5\mu s$, $C_{IN}=\text{Ceramic } 1.0\mu F$)

R1114x151x



R1114x151x



R1114x281x



R1114x281x



R1114x281x



12) Turn-on/off speed with CE pin (D version)

R1114x151D ($V_{IN}=2.5V$, $C_{IN}=\text{Ceramic } 1.0\mu F$, $C_{OUT}=\text{Ceramic } 1.0\mu F$)



R1114x281D ($V_{IN}=3.8V$, $C_{IN}=\text{Ceramic } 0.47\mu F$, $C_{OUT}=\text{Ceramic } 0.47\mu F$)



R1114x401D ($V_{IN}=5.0V$, $C_{IN}=\text{Ceramic } 0.47\mu F$, $C_{OUT}=\text{Ceramic } 0.47\mu F$)



ESR vs. Output Current

When using these ICs, consider the following points:

In these ICs, phase compensation is made for securing stable operation even if the load current is varied. For this purpose, use a capacitor C_{OUT} with good frequency characteristics and ESR (Equivalent Series Resistance) of which is in the range described as follows:



Measuring Circuit for white noise; R1114xxx1B/D

The relations between I_{OUT} (Output Current) and ESR of an output capacitor are shown below. The conditions when the white noise level is under $40\mu\text{V}$ (Avg.) are marked as the hatched area in the graph.

(Note: If additional ceramic capacitors are connected to the Output Pin with Output capacitor for phase compensation, the operation might be unstable. Because of this, test these ICs with as same external components as ones to be used on the PCB.)

<Measurement conditions>

- (1) $V_{IN} = V_{OUT} + 1\text{V}$
- (2) Frequency Band: 10Hz to 2MHz
- (3) Temperature: -40°C to 25°C



R1114x211x

C_{IN}=Ceramic 0.47μF,
C_{OUT}=Ceramic 0.47μF



R1114x281x

C_{IN}=Ceramic 0.47μF,
C_{OUT}=Ceramic 0.47μF



- SOT-23-5 (SC-74A)

Unit: mm

PACKAGE DIMENSIONS



TAPING SPECIFICATION



TAPING REEL DIMENSIONS

(1reel=3000pcs)



POWER DISSIPATION (SOT-23-5)

This specification is at mounted on board. Power Dissipation (P_D) depends on conditions of mounting on board. This specification is based on the measurement at the condition below:

(Power Dissipation (SOT-23-5) is substitution of SOT-23-6.)

Measurement Conditions

| | |
|------------------|--|
| | Standard Land Pattern |
| Environment | Mounting on Board (Wind velocity=0m/s) |
| Board Material | Glass cloth epoxy plactic (Double sided) |
| Board Dimensions | 40mm × 40mm × 1.6mm |
| Copper Ratio | Top side : Approx. 50% , Back side : Approx. 50% |
| Through-hole | φ0.5mm × 44pcs |

Measurement Result

($T_{opt}=25^{\circ}C, T_{jmax}=125^{\circ}C$)

| | | |
|--------------------|--|-------------------|
| | Standard Land Pattern | Free Air |
| Power Dissipation | 420mW | 250mW |
| Thermal Resistance | $\theta_{ja}=(125-25^{\circ}C)/0.42W=263^{\circ}C/W$ | 400 $^{\circ}C/W$ |

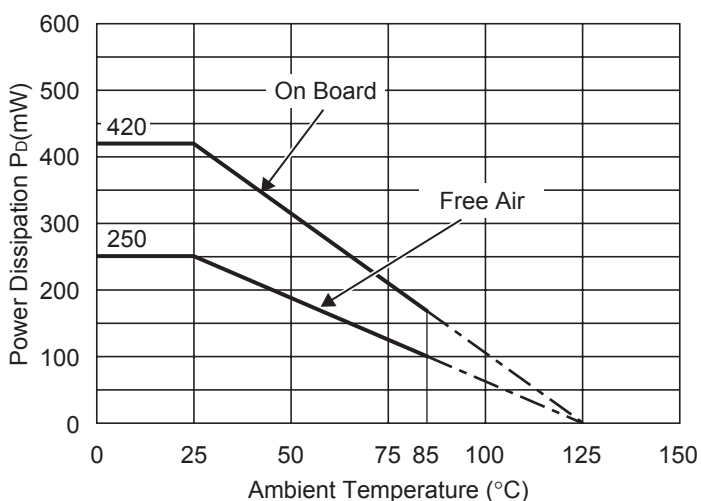

Power Dissipation

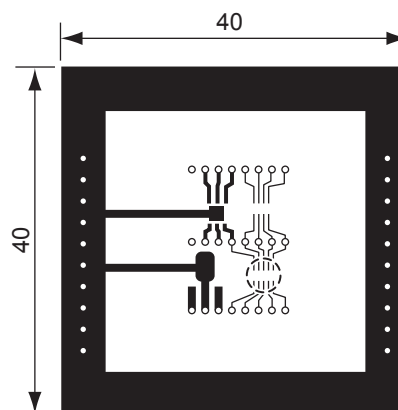

Measurement Board Pattern

○ IC Mount Area Unit : mm

RECOMMENDED LAND PATTERN

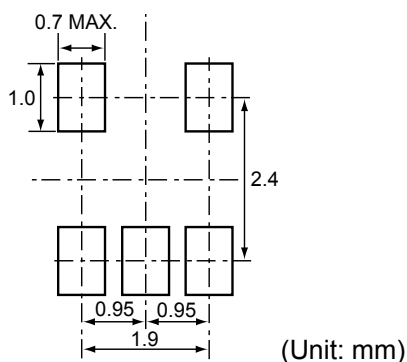

• SC-82AB

Unit: mm

PACKAGE DIMENSIONS



TAPING SPECIFICATION



TAPING REEL DIMENSIONS

(1reel=3000pcs)



POWER DISSIPATION (SC-82AB)

This specification is at mounted on board. Power Dissipation (P_D) depends on conditions of mounting on board. This specification is based on the measurement at the condition below:

Measurement Conditions

| | |
|------------------|--|
| | Standard Land Pattern |
| Environment | Mounting on Board (Wind velocity=0m/s) |
| Board Material | Glass cloth epoxy plactic (Double sided) |
| Board Dimensions | 40mm × 40mm × 1.6mm |
| Copper Ratio | Top side : Approx. 50% , Back side : Approx. 50% |
| Through-hole | φ0.5mm × 44pcs |

Measurement Result

($T_{opt}=25^{\circ}C, T_{jmax}=125^{\circ}C$)

| | | |
|--------------------|--|-------------------|
| | Standard Land Pattern | Free Air |
| Power Dissipation | 380mW | 150mW |
| Thermal Resistance | $\theta_{ja}=(125-25^{\circ}C)/0.38W=263^{\circ}C/W$ | 667 $^{\circ}C/W$ |

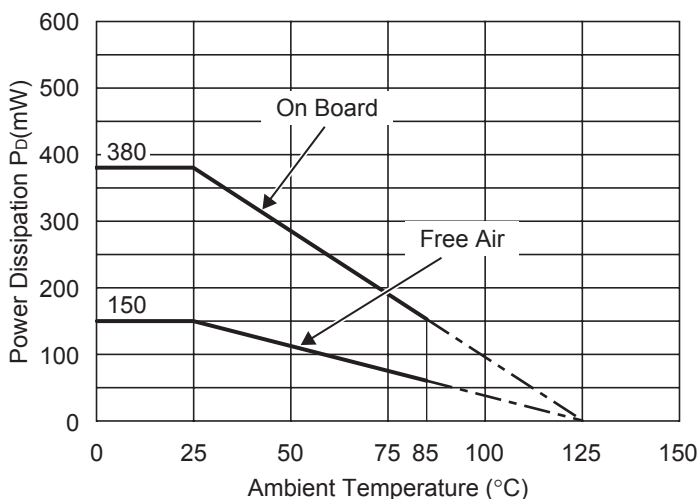

Power Dissipation

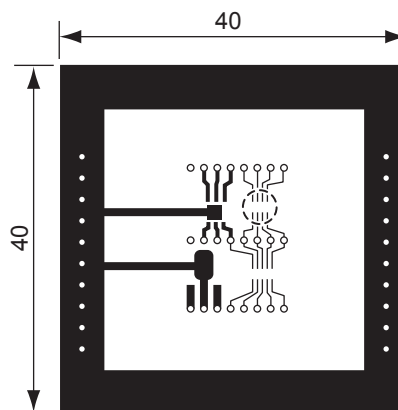

Measurement Board Pattern

○ IC Mount Area (Unit : mm)

RECOMMENDED LAND PATTERN

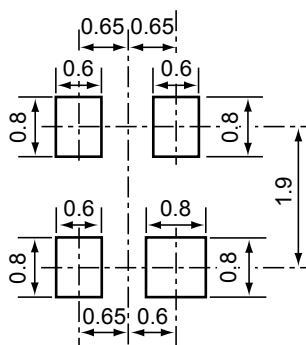

(Unit: mm)

Power Dissipation (SON1612-6)

This specification is at mounted on board.

Power Dissipation (P_D) depends on conditions of mounting on board. This specification is based on the measurement at the condition below:

Measurement Conditions

| | |
|------------------|--|
| | Standard Land Pattern |
| Environment | Mounting on Board (Wind velocity=0m/s) |
| Board Material | Glass cloth epoxy plastic (Double sided) |
| Board Dimensions | 40mm × 40mm × 1.6mm |
| Copper Ratio | Top side : Approx. 50%, Back side : Approx.50% |
| Through-hole | φ0.5mm × 24pcs |

Measurement Result

($T_{opt}=25^{\circ}C, T_{jmax}=125^{\circ}C$)

| | |
|--------------------|---|
| | Standard Land Pattern |
| Power Dissipation | 500mW |
| Thermal Resistance | $\theta_{ja}=(125-25^{\circ}C)/0.5W=200^{\circ}C/W$ |

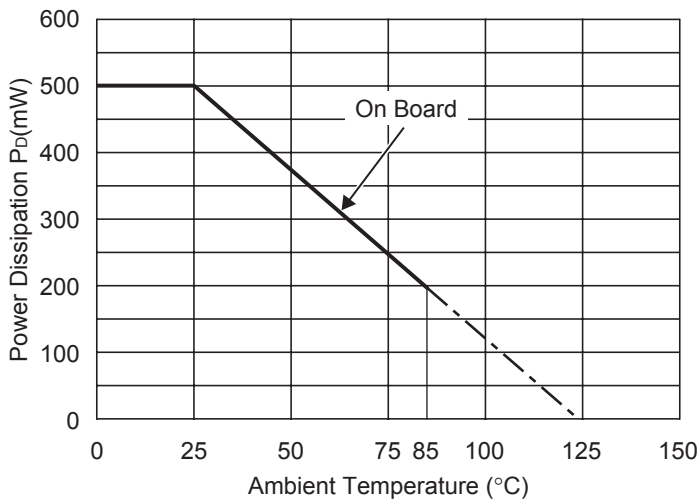

Power Dissipation

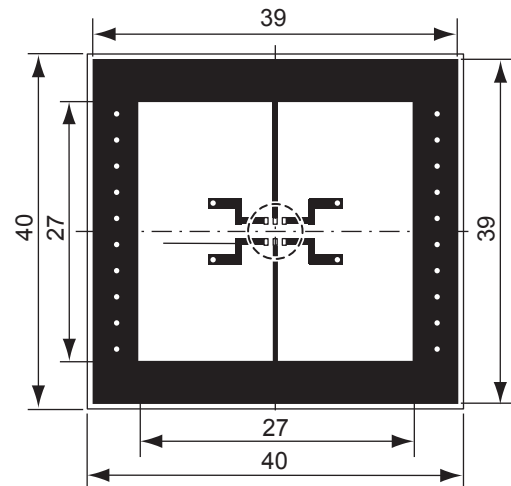

Measurement Board Pattern

○ IC Mount Area Unit : mm

RECOMMENDED LAND PATTERN



(Unit: mm)

R1114N SERIES MARK SPECIFICATION

● **SOT-23-5 (SC-74A)**



①, ②, ③ : Product Code (refer to Part Number vs. Product Code)
 ④, ⑤ : Lot Number

● **Part Number vs. Product Code**

| Part Number | Product Code | | |
|-------------|--------------|---|---|
| | ① | ② | ③ |
| R1114N151A | 4 | 1 | 5 |
| R1114N161A | 4 | 1 | 6 |
| R1114N171A | 4 | 1 | 7 |
| R1114N181A | 4 | 1 | 8 |
| R1114N191A | 4 | 1 | 9 |
| R1114N201A | 4 | 2 | 0 |
| R1114N211A | 4 | 2 | 1 |
| R1114N221A | 4 | 2 | 2 |
| R1114N231A | 4 | 2 | 3 |
| R1114N241A | 4 | 2 | 4 |
| R1114N251A | 4 | 2 | 5 |
| R1114N261A | 4 | 2 | 6 |
| R1114N271A | 4 | 2 | 7 |
| R1114N281A | 4 | 2 | 8 |
| R1114N291A | 4 | 2 | 9 |
| R1114N301A | 4 | 3 | 0 |
| R1114N311A | 4 | 3 | 1 |
| R1114N321A | 4 | 3 | 2 |
| R1114N331A | 4 | 3 | 3 |
| R1114N341A | 4 | 3 | 4 |
| R1114N351A | 4 | 3 | 5 |
| R1114N361A | 4 | 3 | 6 |
| R1114N371A | 4 | 3 | 7 |
| R1114N381A | 4 | 3 | 8 |
| R1114N391A | 4 | 3 | 9 |
| R1114N401A | 4 | 4 | 0 |
| R1114N281A5 | 4 | 4 | 1 |

| Part Number | Product Code | | |
|-------------|--------------|---|---|
| | ① | ② | ③ |
| R1114N151B | 5 | 1 | 5 |
| R1114N161B | 5 | 1 | 6 |
| R1114N171B | 5 | 1 | 7 |
| R1114N181B | 5 | 1 | 8 |
| R1114N191B | 5 | 1 | 9 |
| R1114N201B | 5 | 2 | 0 |
| R1114N211B | 5 | 2 | 1 |
| R1114N221B | 5 | 2 | 2 |
| R1114N231B | 5 | 2 | 3 |
| R1114N241B | 5 | 2 | 4 |
| R1114N251B | 5 | 2 | 5 |
| R1114N261B | 5 | 2 | 6 |
| R1114N271B | 5 | 2 | 7 |
| R1114N281B | 5 | 2 | 8 |
| R1114N291B | 5 | 2 | 9 |
| R1114N301B | 5 | 3 | 0 |
| R1114N311B | 5 | 3 | 1 |
| R1114N321B | 5 | 3 | 2 |
| R1114N331B | 5 | 3 | 3 |
| R1114N341B | 5 | 3 | 4 |
| R1114N351B | 5 | 3 | 5 |
| R1114N361B | 5 | 3 | 6 |
| R1114N371B | 5 | 3 | 7 |
| R1114N381B | 5 | 3 | 8 |
| R1114N391B | 5 | 3 | 9 |
| R1114N401B | 5 | 4 | 0 |
| R1114N281B5 | 5 | 4 | 1 |

| Part Number | Product Code | | |
|-------------|--------------|---|---|
| | ① | ② | ③ |
| R1114N151D | 6 | 1 | 5 |
| R1114N161D | 6 | 1 | 6 |
| R1114N171D | 6 | 1 | 7 |
| R1114N181D | 6 | 1 | 8 |
| R1114N191D | 6 | 1 | 9 |
| R1114N201D | 6 | 2 | 0 |
| R1114N211D | 6 | 2 | 1 |
| R1114N221D | 6 | 2 | 2 |
| R1114N231D | 6 | 2 | 3 |
| R1114N241D | 6 | 2 | 4 |
| R1114N251D | 6 | 2 | 5 |
| R1114N261D | 6 | 2 | 6 |
| R1114N271D | 6 | 2 | 7 |
| R1114N281D | 6 | 2 | 8 |
| R1114N291D | 6 | 2 | 9 |
| R1114N301D | 6 | 3 | 0 |
| R1114N311D | 6 | 3 | 1 |
| R1114N321D | 6 | 3 | 2 |
| R1114N331D | 6 | 3 | 3 |
| R1114N341D | 6 | 3 | 4 |
| R1114N351D | 6 | 3 | 5 |
| R1114N361D | 6 | 3 | 6 |
| R1114N371D | 6 | 3 | 7 |
| R1114N381D | 6 | 3 | 8 |
| R1114N391D | 6 | 3 | 9 |
| R1114N401D | 6 | 4 | 0 |
| R1114N281D5 | 6 | 4 | 1 |

R1114Q SERIES MARK SPECIFICATION

● **SC-82AB**



①, ② : Product Code (refer to Part Number vs. Product Code)

③, ④ : Lot Number

● **Part Number vs. Product Code**

| Part Number | Product Code | |
|-------------|--------------|---|
| | ① | ② |
| R1114Q151A | J | F |
| R1114Q161A | J | G |
| R1114Q171A | J | H |
| R1114Q181A | J | J |
| R1114Q191A | J | K |
| R1114Q201A | K | A |
| R1114Q211A | K | B |
| R1114Q221A | K | C |
| R1114Q231A | K | D |
| R1114Q241A | K | E |
| R1114Q251A | K | F |
| R1114Q261A | K | G |
| R1114Q271A | K | H |
| R1114Q281A | K | J |
| R1114Q291A | K | K |
| R1114Q301A | L | A |
| R1114Q311A | L | B |
| R1114Q321A | L | C |
| R1114Q331A | L | D |
| R1114Q341A | L | E |
| R1114Q351A | L | F |
| R1114Q361A | L | G |
| R1114Q371A | L | H |
| R1114Q381A | L | J |
| R1114Q391A | L | K |
| R1114Q401A | M | A |
| R1114Q281A5 | M | B |

| Part Number | Product Code | |
|-------------|--------------|---|
| | ① | ② |
| R1114Q151B | N | F |
| R1114Q161B | N | G |
| R1114Q171B | N | H |
| R1114Q181B | N | J |
| R1114Q191B | N | K |
| R1114Q201B | P | A |
| R1114Q211B | P | B |
| R1114Q221B | P | C |
| R1114Q231B | P | D |
| R1114Q241B | P | E |
| R1114Q251B | P | F |
| R1114Q261B | P | G |
| R1114Q271B | P | H |
| R1114Q281B | P | J |
| R1114Q291B | P | K |
| R1114Q301B | Q | A |
| R1114Q311B | Q | B |
| R1114Q321B | Q | C |
| R1114Q331B | Q | D |
| R1114Q341B | Q | E |
| R1114Q351B | Q | F |
| R1114Q361B | Q | G |
| R1114Q371B | Q | H |
| R1114Q381B | Q | J |
| R1114Q391B | Q | K |
| R1114Q401B | R | A |
| R1114Q281B5 | R | B |

| Part Number | Product Code | |
|-------------|--------------|---|
| | ① | ② |
| R1114Q151D | S | F |
| R1114Q161D | S | G |
| R1114Q171D | S | H |
| R1114Q181D | S | J |
| R1114Q191D | S | K |
| R1114Q201D | T | A |
| R1114Q211D | T | B |
| R1114Q221D | T | C |
| R1114Q231D | T | D |
| R1114Q241D | T | E |
| R1114Q251D | T | F |
| R1114Q261D | T | G |
| R1114Q271D | T | H |
| R1114Q281D | T | J |
| R1114Q291D | T | K |
| R1114Q301D | U | A |
| R1114Q311D | U | B |
| R1114Q321D | U | C |
| R1114Q331D | U | D |
| R1114Q341D | U | E |
| R1114Q351D | U | F |
| R1114Q361D | U | G |
| R1114Q371D | U | H |
| R1114Q381D | U | J |
| R1114Q391D | U | K |
| R1114Q401D | V | A |
| R1114Q281D5 | V | B |

R1114D SERIES MARK SPECIFICATION

● SON1612-6



① ~ ④ : Product Code (refer to Part Number vs. Product Code)

⑤, ⑥ : Lot Number

● Part Number vs. Product Code

| Part Number | Product Code | | | |
|-------------|--------------|---|---|---|
| | ① | ② | ③ | ④ |
| R1114D151A | F | 1 | 5 | A |
| R1114D161A | F | 1 | 6 | A |
| R1114D171A | F | 1 | 7 | A |
| R1114D181A | F | 1 | 8 | A |
| R1114D191A | F | 1 | 9 | A |
| R1114D201A | F | 2 | 0 | A |
| R1114D211A | F | 2 | 1 | A |
| R1114D221A | F | 2 | 2 | A |
| R1114D231A | F | 2 | 3 | A |
| R1114D241A | F | 2 | 4 | A |
| R1114D251A | F | 2 | 5 | A |
| R1114D261A | F | 2 | 6 | A |
| R1114D271A | F | 2 | 7 | A |
| R1114D281A | F | 2 | 8 | A |
| R1114D291A | F | 2 | 9 | A |
| R1114D301A | F | 3 | 0 | A |
| R1114D311A | F | 3 | 1 | A |
| R1114D321A | F | 3 | 2 | A |
| R1114D331A | F | 3 | 3 | A |
| R1114D341A | F | 3 | 4 | A |
| R1114D351A | F | 3 | 5 | A |
| R1114D361A | F | 3 | 6 | A |
| R1114D371A | F | 3 | 7 | A |
| R1114D381A | F | 3 | 8 | A |
| R1114D391A | F | 3 | 9 | A |
| R1114D401A | F | 4 | 0 | A |
| R1114D281A5 | F | 4 | 1 | A |
| R1114D181A5 | F | 4 | 2 | A |

| Part Number | Product Code | | | |
|-------------|--------------|---|---|---|
| | ① | ② | ③ | ④ |
| R1114D151B | F | 1 | 5 | B |
| R1114D161B | F | 1 | 6 | B |
| R1114D171B | F | 1 | 7 | B |
| R1114D181B | F | 1 | 8 | B |
| R1114D191B | F | 1 | 9 | B |
| R1114D201B | F | 2 | 0 | B |
| R1114D211B | F | 2 | 1 | B |
| R1114D221B | F | 2 | 2 | B |
| R1114D231B | F | 2 | 3 | B |
| R1114D241B | F | 2 | 4 | B |
| R1114D251B | F | 2 | 5 | B |
| R1114D261B | F | 2 | 6 | B |
| R1114D271B | F | 2 | 7 | B |
| R1114D281B | F | 2 | 8 | B |
| R1114D291B | F | 2 | 9 | B |
| R1114D301B | F | 3 | 0 | B |
| R1114D311B | F | 3 | 1 | B |
| R1114D321B | F | 3 | 2 | B |
| R1114D331B | F | 3 | 3 | B |
| R1114D341B | F | 3 | 4 | B |
| R1114D351B | F | 3 | 5 | B |
| R1114D361B | F | 3 | 6 | B |
| R1114D371B | F | 3 | 7 | B |
| R1114D381B | F | 3 | 8 | B |
| R1114D391B | F | 3 | 9 | B |
| R1114D401B | F | 4 | 0 | B |
| R1114D281B5 | F | 4 | 1 | B |
| R1114D181B5 | F | 4 | 2 | B |

| Part Number | Product Code | | | |
|-------------|--------------|---|---|---|
| | ① | ② | ③ | ④ |
| R1114D151D | F | 1 | 5 | D |
| R1114D161D | F | 1 | 6 | D |
| R1114D171D | F | 1 | 7 | D |
| R1114D181D | F | 1 | 8 | D |
| R1114D191D | F | 1 | 9 | D |
| R1114D201D | F | 2 | 0 | D |
| R1114D211D | F | 2 | 1 | D |
| R1114D221D | F | 2 | 2 | D |
| R1114D231D | F | 2 | 3 | D |
| R1114D241D | F | 2 | 4 | D |
| R1114D251D | F | 2 | 5 | D |
| R1114D261D | F | 2 | 6 | D |
| R1114D271D | F | 2 | 7 | D |
| R1114D281D | F | 2 | 8 | D |
| R1114D291D | F | 2 | 9 | D |
| R1114D301D | F | 3 | 0 | D |
| R1114D311D | F | 3 | 1 | D |
| R1114D321D | F | 3 | 2 | D |
| R1114D331D | F | 3 | 3 | D |
| R1114D341D | F | 3 | 4 | D |
| R1114D351D | F | 3 | 5 | D |
| R1114D361D | F | 3 | 6 | D |
| R1114D371D | F | 3 | 7 | D |
| R1114D381D | F | 3 | 8 | D |
| R1114D391D | F | 3 | 9 | D |
| R1114D401D | F | 4 | 0 | D |
| R1114D281D5 | F | 4 | 1 | D |
| R1114D181D5 | F | 4 | 2 | D |



Компания «ЭлектроПласт» предлагает заключение долгосрочных отношений при поставках импортных электронных компонентов на взаимовыгодных условиях!

Наши преимущества:

- Оперативные поставки широкого спектра электронных компонентов отечественного и импортного производства напрямую от производителей и с крупнейших мировых складов;
- Поставка более 17-ти миллионов наименований электронных компонентов;
- Поставка сложных, дефицитных, либо снятых с производства позиций;
- Оперативные сроки поставки под заказ (от 5 рабочих дней);
- Экспресс доставка в любую точку России;
- Техническая поддержка проекта, помощь в подборе аналогов, поставка прототипов;
- Система менеджмента качества сертифицирована по Международному стандарту ISO 9001;
- Лицензия ФСБ на осуществление работ с использованием сведений, составляющих государственную тайну;
- Поставка специализированных компонентов (Xilinx, Altera, Analog Devices, Intersil, Interpoint, Microsemi, Aeroflex, Peregrine, Syfer, Eurofarad, Texas Instrument, Miteq, Cobham, E2V, MA-COM, Hittite, Mini-Circuits, General Dynamics и др.);

Помимо этого, одним из направлений компании «ЭлектроПласт» является направление «Источники питания». Мы предлагаем Вам помощь Конструкторского отдела:

- Подбор оптимального решения, техническое обоснование при выборе компонента;
- Подбор аналогов;
- Консультации по применению компонента;
- Поставка образцов и прототипов;
- Техническая поддержка проекта;
- Защита от снятия компонента с производства.



Как с нами связаться

Телефон: 8 (812) 309 58 32 (многоканальный)

Факс: 8 (812) 320-02-42

Электронная почта: org@eplast1.ru

Адрес: 198099, г. Санкт-Петербург, ул. Калинина, дом 2, корпус 4, литера А.