

Features

- Diffused Junction
- Ultra-Fast Switching for High Efficiency
- Low Reverse Leakage Current
- Surge Overload Rating to 30A Peak
- IEC 61000-4-2 (ESD - 150pF/330Ω)
UF1001 – UF1003: Contact: discharge - ±15kV
- Lead Free Finish, RoHS Compliant (Note 4)

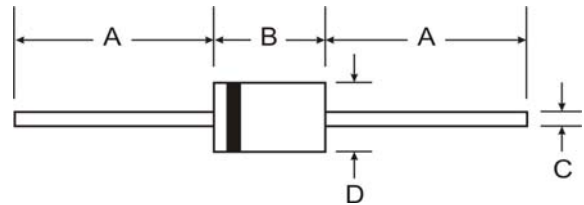

Mechanical Data

- Case: DO-41
- Case Material: Molded Plastic. UL Flammability Classification Rating 94V-0
- Moisture Sensitivity: Level 1 per J-STD-020C
- Terminals: Finish - Tin. Plated Leads Solderable per MIL-STD-202, Method 208 (3)
- Polarity: Cathode Band
- Marking: Type Number
- Ordering Information: See Page
- Weight: 0.35 grams (approximate)

DO-41		
Dim	Min	Max
A	25.40	—
B	4.06	5.21
C	0.71	0.864
D	2.00	2.72
All Dimensions in mm		

Maximum Ratings and Electrical Characteristics @T_A = 25°C unless otherwise specified

Characteristic	Symbol	UF 1001	UF 1002	UF 1003	UF 1004	UF 1005	UF 1006	UF 1007	Unit	
Peak Repetitive Reverse Voltage	V _{RRM}	50	100	200	400	600	800	1000	V	
Working Peak Reverse Voltage	V _{RWM}									
DC Blocking Voltage (Note 5)	V _R									
RMS Reverse Voltage	V _{R(RMS)}	35	70	140	280	420	560	700	V	
Average Rectified Output Current (Note 1) @ T _A = 55°C	I _O	1.0							A	
Non-Repetitive Peak Forward Surge Current 8.3ms Single half sine-wave Superimposed on Rated Load	I _{FSM}	30							A	
Forward Voltage @ I _F = 1.0A	V _{FM}	1.0		1.3		1.7			V	
Peak Reverse Current @ T _A = 25°C at Rated DC Blocking Voltage (Note 5) @ T _A = 100°C	I _{RM}	5.0				100				μA
Reverse Recovery Time (Note 3)	t _{rr}	50			75				ns	
Typical Total Capacitance (Note 2)	C _T	20			10				pF	
Typical Thermal Resistance Junction to Ambient	R _{θJA}	95							°C/W	
Operating and Storage Temperature Range	T _i , T _{STG}	-65 to +150							°C	

- Notes:
1. Valid provided that leads are maintained at ambient temperature at a distance of 9.5mm from the case.
 2. Measured at 1.0MHz and applied reverse voltage of 4.0V DC.
 3. Measured with I_F = 0.5A, I_R = 1.0A, I_{rr} = 0.25A. See figure 5.
 4. RoHS revision 13.2.2003. High temperature solder exemption applied, see *EU Directive Annex Note 7*.
 5. Short duration pulse test used to minimize self-heating effect.

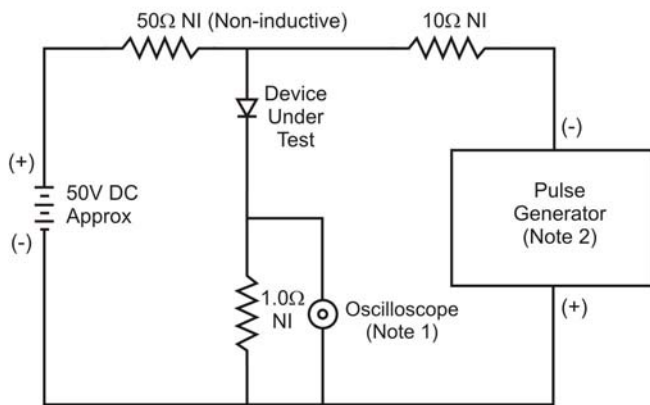
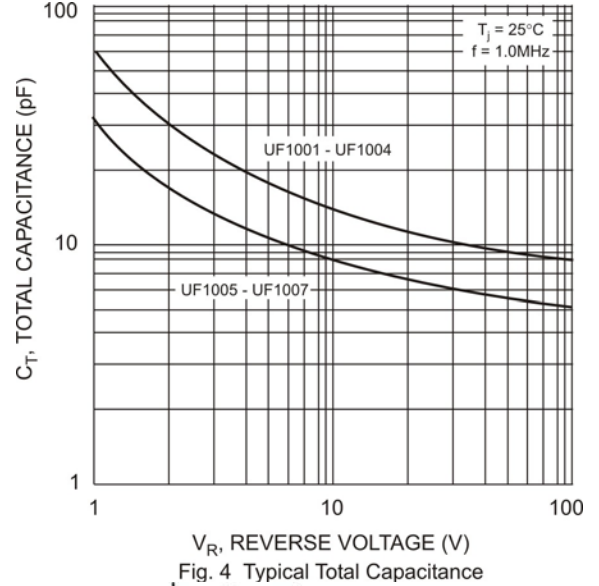
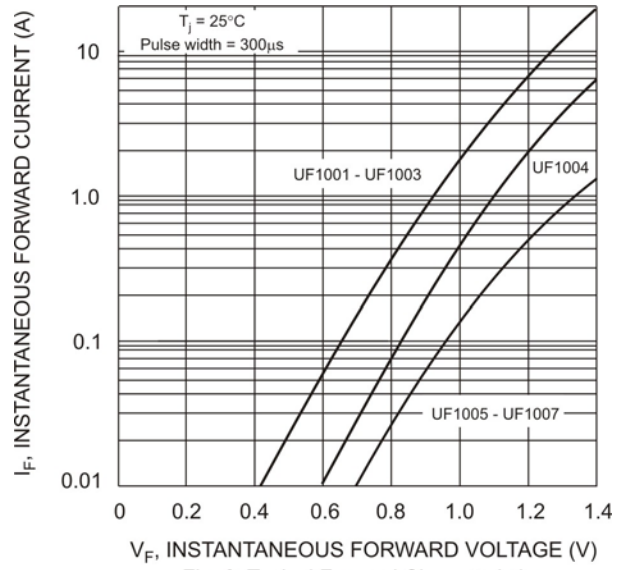
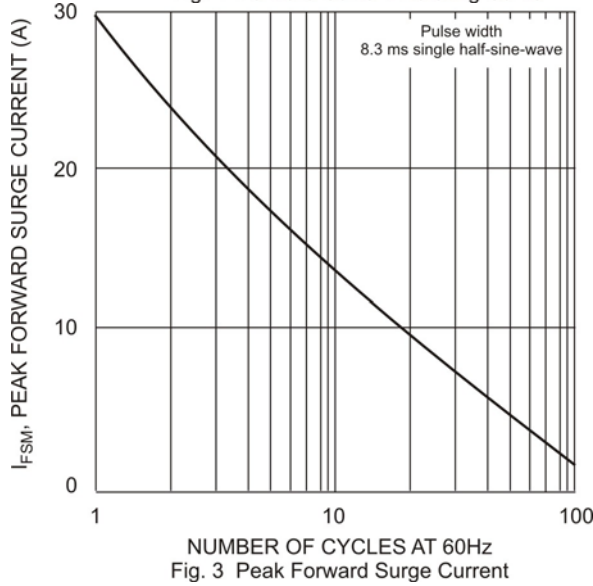
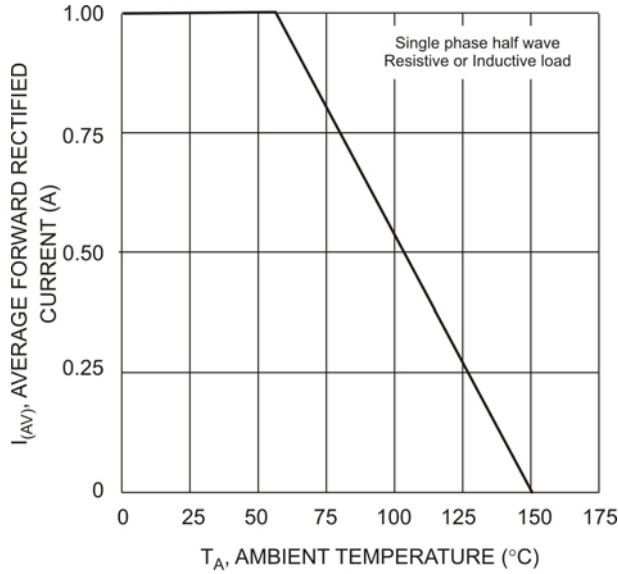

- Notes:
1. Rise Time = 7.0ns max. Input Impedance = 1.0MΩ, 22pF.
 2. Rise Time = 10ns max. Input Impedance = 50Ω.

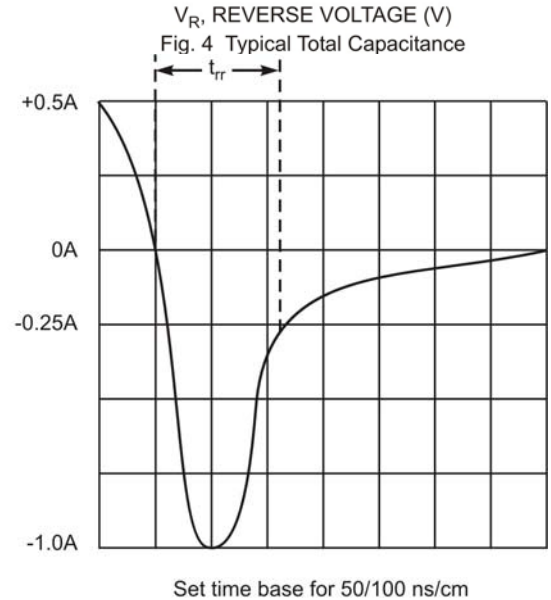

Fig. 5 Reverse Recovery Time Characteristic and Test Circuit

Ordering Information (Note 6)

Device	Packaging	Shipping
UF1001-A	DO-41	5K/Ammo Pack
UF1001-B	DO-41	1K/Bulk
UF1001-T	DO-41	5K/Tape & Reel, 13-inch
UF1002-A	DO-41	5K/Ammo Pack
UF1002-B	DO-41	1K/Bulk
UF1002-T	DO-41	5K/Tape & Reel, 13-inch
UF1003-A	DO-41	5K/Ammo Pack
UF1003-B	DO-41	1K/Bulk
UF1003-T	DO-41	5K/Tape & Reel, 13-inch
UF1004-A	DO-41	5K/Ammo Pack
UF1004-B	DO-41	1K/Bulk
UF1004-T	DO-41	5K/Tape & Reel, 13-inch
UF1005-A	DO-41	5K/Ammo Pack
UF1005-B	DO-41	1K/Bulk
UF1005-T	DO-41	5K/Tape & Reel, 13-inch
UF1006-A	DO-41	5K/Ammo Pack
UF1006-B	DO-41	1K/Bulk
UF1006-T	DO-41	5K/Tape & Reel, 13-inch
UF1007-A	DO-41	5K/Ammo Pack
UF1007-B	DO-41	1K/Bulk
UF1007-T	DO-41	5K/Tape & Reel, 13-inch

Notes: 6. For packaging details, visit our website at <http://www.diodes.com/datasheets/ap02008.pdf>.

IMPORTANT NOTICE

Diodes Incorporated and its subsidiaries reserve the right to make modifications, enhancements, improvements, corrections or other changes without further notice to any product herein. Diodes Incorporated does not assume any liability arising out of the application or use of any product described herein; neither does it convey any license under its patent rights, nor the rights of others. The user of products in such applications shall assume all risks of such use and will agree to hold Diodes Incorporated and all the companies whose products are represented on our website, harmless against all damages.

LIFE SUPPORT

Diodes Incorporated products are not authorized for use as critical components in life support devices or systems without the expressed written approval of the President of Diodes Incorporated.



Компания «ЭлектроПласт» предлагает заключение долгосрочных отношений при поставках импортных электронных компонентов на взаимовыгодных условиях!

Наши преимущества:

- Оперативные поставки широкого спектра электронных компонентов отечественного и импортного производства напрямую от производителей и с крупнейших мировых складов;
- Поставка более 17-ти миллионов наименований электронных компонентов;
- Поставка сложных, дефицитных, либо снятых с производства позиций;
- Оперативные сроки поставки под заказ (от 5 рабочих дней);
- Экспресс доставка в любую точку России;
- Техническая поддержка проекта, помощь в подборе аналогов, поставка прототипов;
- Система менеджмента качества сертифицирована по Международному стандарту ISO 9001;
- Лицензия ФСБ на осуществление работ с использованием сведений, составляющих государственную тайну;
- Поставка специализированных компонентов (Xilinx, Altera, Analog Devices, Intersil, Interpoint, Microsemi, Aeroflex, Peregrine, Syfer, Eurofarad, Texas Instrument, Miteq, Cobham, E2V, MA-COM, Hittite, Mini-Circuits, General Dynamics и др.);

Помимо этого, одним из направлений компании «ЭлектроПласт» является направление «Источники питания». Мы предлагаем Вам помощь Конструкторского отдела:

- Подбор оптимального решения, техническое обоснование при выборе компонента;
- Подбор аналогов;
- Консультации по применению компонента;
- Поставка образцов и прототипов;
- Техническая поддержка проекта;
- Защита от снятия компонента с производства.



Как с нами связаться

Телефон: 8 (812) 309 58 32 (многоканальный)

Факс: 8 (812) 320-02-42

Электронная почта: org@eplast1.ru

Адрес: 198099, г. Санкт-Петербург, ул. Калинина, дом 2, корпус 4, литера А.