

Single phase - general purpose

Comprehensive family of single and multi-stage chassis mount filters. Throughout the power range, a high level of performance is provided within various sizes and styles of metal enclosure and termination options.

Designed to provide economic solutions to a multitude of general purpose filtering requirements; industrial power equipment, office, business and medical equipments.

The two stage FAS series is specifically designed to suppress RFI generated by switch mode power supply applications.

- Current ratings from 0.5A to 40A
- High symmetric and asymmetric attenuation
- Earth line choke and medical versions available
- Custom designs to client specifications

Mechanical Specifications

Manufacture: metal case and cover, internal components sealed with self-extinguishing resin.

Connections: faston 6.3 x 0.8mm ($\leq 16A$), flexible leads, screws M4 ($\leq 40A$) ground terminal connected to case.

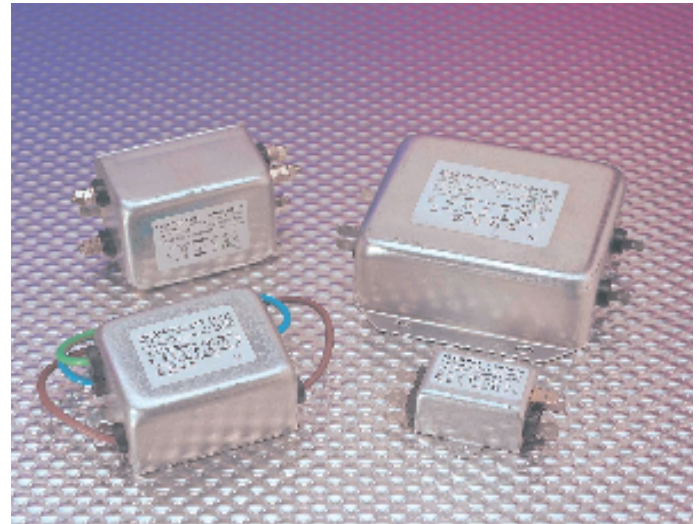

Electrical Specifications

Rated voltage (V_R): max 250V, 50/60Hz

Rated current (I_R): referred to room temperature = 40°C

Leakage current (I_L): at 220V, 50Hz, max value

Voltage test (2 s.): line to ground 3000Vdc or 1800Vac
line to line 1700Vdc

Climatic category: HPF (25/085/21);

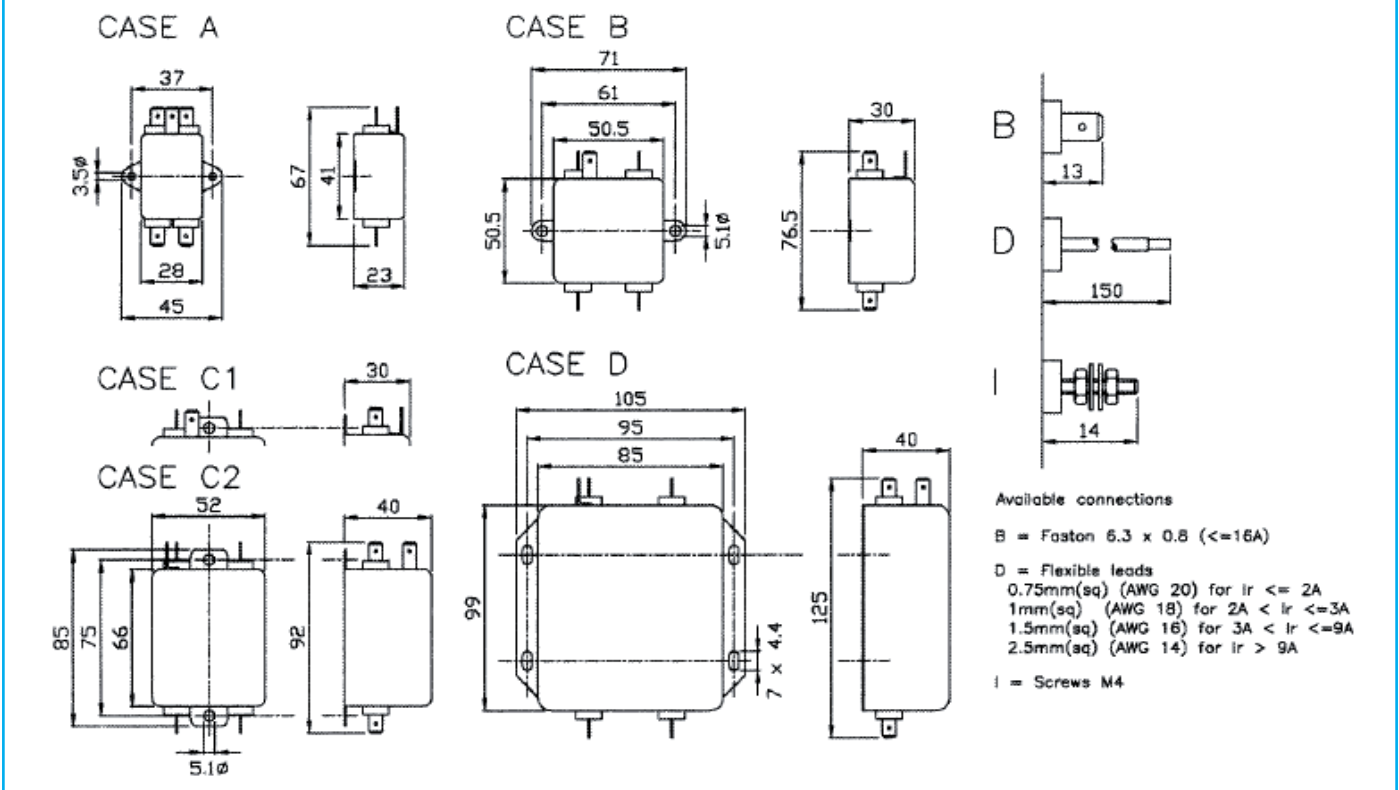

Temperature range: -25°C to +85°C

Dimensions (mm)



Filter Range

FAI Code	I _R (A)	L (mH)	C _x (μF)	C _y (pF)	I _L (mA)	R (MΩ)	Circ Diag	Case
FAIDB2150ZA	1.5	2x10	0.015	2x2200	2x0.2		A	A
FAIDB2150ZB	1	2x10	0.015	2x2200	2x0.2		A	A
FAIDB2150ZC	3	2x2	0.015	2x2200	2x0.2		A	A
FAIDB2150ZD	6.5	2x1	0.015	2x2200	2x0.2		A	A
FAID-2330ZA	10	2x0.5	0.033	2x2200	2x0.2	1	B	B
FAID-2330ZB	20	2x0.5	0.033	2x2200	2x0.2	1	B	B
FAID-2330ZC	30	2x0.6	0.033	2x2200	2x0.2	1	B	D
FAID-3100ZA	5	2x1	0.1	2x3200	2x0.29	1	B	B
FAID-3100ZB	5	2x1.7	0.1	2x3200	2x0.29	1	B	B



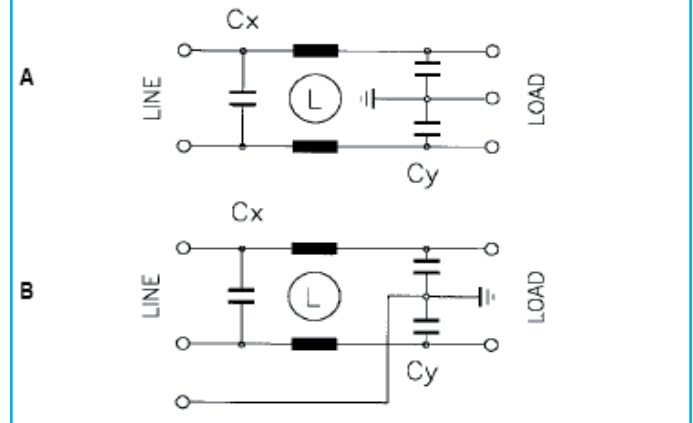

 B = Faston 6.3x0.8mm
 D = Flexible leads
 I = Screw M4

* other variants on request

Circuit diagram



FAK Code	I _R (A)	L ₁ (mH)	L ₂ (mH)	C _{x1} (μF)	C _{x2} (μF)	C _{x3} (μF)	C _{y1} (pF)	C _{y2} (pF)	I _L (mA)	R (MΩ)	Circ Diag	Case
FAKD-3300ZA	3	2x2	2x2	0.15	0.15		2x2200		2x0.2	1	E	C1
FAKD-3300ZB	6	2x1	2x1	0.15	0.15		2x2200		2x0.2	1	E	C1
FAKD-3300ZC	10	2x0.5	2x0.5	0.15	0.15		2x2200		2x0.2	1	E	C2
FAKD-3300ZD	20	2x0.5	2x0.5	0.15	0.15		2x2200		2x0.2	1	E	D
FAKD-3570ZA	2.5	2x1	2x2.5		0.47	0.1	2x3300	2x3300	2x0.6	0.68	E	D
FAKD-3810ZA	10	2x2.3	2x2.3	0.27	0.27	0.27	2x5500	2x1000	2x0.6	0.33	E	D
FAKD-3940ZA	3	2x4.7	2x4.7	0.47	0.47		2x4700		2x0.5	0.24	F	C2



 B = Faston 6.3x0.8mm
 D = Flexible leads
 I = Screw M4
 VDE 60939-2
 UL approval only

* other variants on request

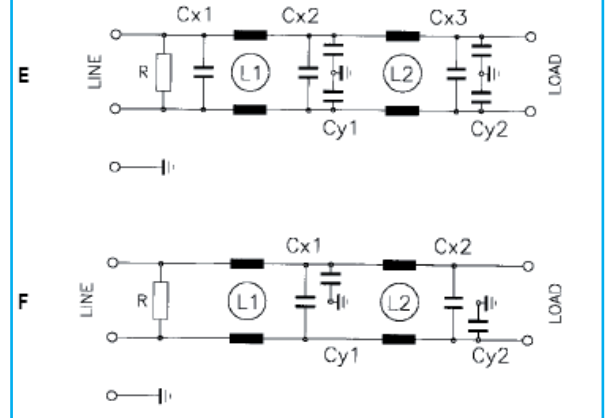
Circuit diagram



FAM Code	I _R (A)	L (mH)	C _{x1} (μF)	C _{x2} (μF)	C _y (pF)	I _L (mA)	R (MΩ)	Circ Diag	Case
FAMD-3200ZA	1	2x40	0.1	0.1	2x4700	2x0.43	0.68	C	B
FAMD-3200ZB	5	2x1	0.1	0.1	2x3200	2x0.29	0.68	C	B
FAMD-3200ZC	10	2x0.5	0.1	0.1	2x2200	2x0.20	0.68	C	B
FAMD-3200ZD	20	2x0.5	0.1	0.1	2x2200	2x0.20	0.68	C	C2
FAMD-3200ZE	30	2x0.6	0.1	0.1	2x2200	2x0.20	0.68	C	D
▲ FAMD-3440ZA	10	2x1	0.22	0.22	2x4700	2x0.43	0.47	D	B
FAMD-3470ZA	6.5	2x4		0.47	2x1000	2x0.09	0.68	C	C2
FAMD-3600ZC	16	2x1		0.6	2x2500	2x0.23	0.47	C	C2
FAMD-3600ZD	22	2x0.2		0.6	2x2500	2x0.23	0.47	C	C2
▲ FAMD-3600ZE	20	2x1		0.6	2x4700	2x0.43	0.47	D	C2
▲ FAMD-3600ZF	40	2x0.23		0.6	2x4700	2x0.43	0.47	D	C2
▲ FAMD-3600ZH	30	2x0.23		0.6	2x4700	2x0.43	0.47	D	C2
▲ FAMD-3600ZK	25	2x0.5	0.6		2x4700	2x0.43	0.47	D	C2
▲ FAMD-3600ZL	25	2x0.5	0.6		2x22000	2x2.0	0.47	D	C2
FAMD-3940ZA	4.5	2x20	0.47	0.47	2x10000	2x0.91	0.33	C	C2
FAMD-3940ZB	3.3	2x13	0.47	0.47	2x6800	2x0.62	0.33	C	C2
■ FAMD-4100ZB	16	2x0.5		1.0	2x2500	2x0.23	0.33	D	C2
▲ FAMD-4160ZA	25	2x0.5	1.0	0.68	2x22000	2x2.0	0.47	C	C2

 B = Faston 6.3x0.8mm
 D = Flexible leads
 I = Screw M4
 ▲ VDE 60939-2 only
 ■ UL approval only

* other variants on request

Circuit diagram

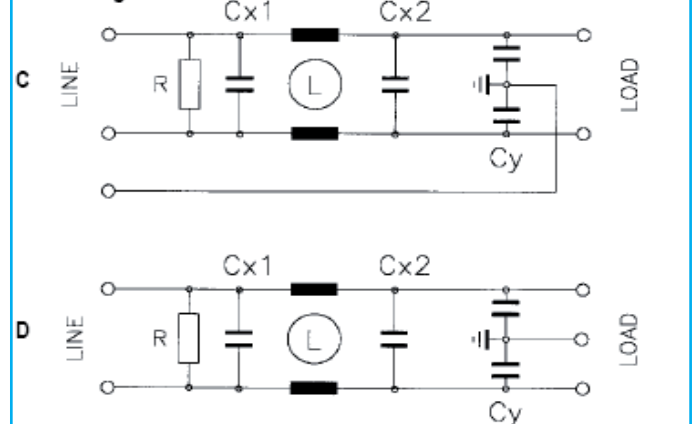

Filter Range

FAR Code	I _r (A)	L ₁ (mH)	L ₂ (mH)	C _{x1} (μF)	C _{x2} (μF)	C _{y1} (pF)	C _{y2} (pF)	I _L (mA)	R (MΩ)	Circ Diag	Case
FARD-3620ZA	1.5	2x7	2x7	0.47	0.15		2x2200	2x0.2	0.47	G	C2
FARD-3620ZB	2.5	2x12	2x2	0.47	0.15		2x2200	2x0.2	0.47	G	C2
FARD-3620ZC	5	2x7	2x7	0.47	0.15		2x2200	2x0.2	0.47	G	C2
FARD-3620ZD	8.5	2x10	2x3	0.47	0.15		2x2200	2x0.2	0.47	G	D
▲ FARD-3940ZA	0.5	2x40	2x40	0.47	0.47		2x3300		2x0.3	G	C1



 B = Faston 6.3x0.8mm
 D = Flexible leads
 I = Screw M4

▲ VDE 60939-2 only

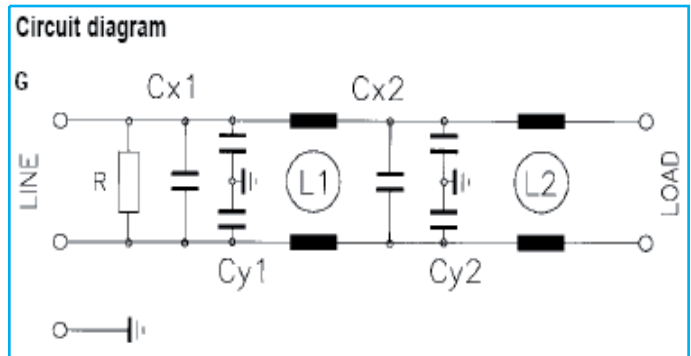
* other variants on request



FAS Code	I _r (A)	L ₁ (mH)	L ₂ (mH)	C _{x1} (μF)	C _y (pF)	I _L (mA)	R (MΩ)	Circ Diag	Case
FASD-3220ZA	1	2x22	2x0.3	0.22	2x4700	2x0.43	1	H	B
FASD-3220ZB	2.5	2x16	2x0.3	0.22	2x4700	2x0.43	1	H	C2
FASD-3470ZA	6.5	2x4	2x0.05	0.47	2x22000	2x2	0.47	H	D
FASD-3470ZB	10	2x4	2x0.05	0.47	2x22000	2x2	0.47	H	D
FASD-3940ZA	4	2x8	2x0.05	0.94	2x22000	2x2	0.33	H	C2
▲ FASD-3940ZC	10	2x4	2x0.05	2x0.47	2x22000	2x2	0.33	H	D

 B = Faston 6.3x0.8mm
 D = Flexible leads
 I = Screw M4

▲ VDE 60939-2 only

* other variants on request

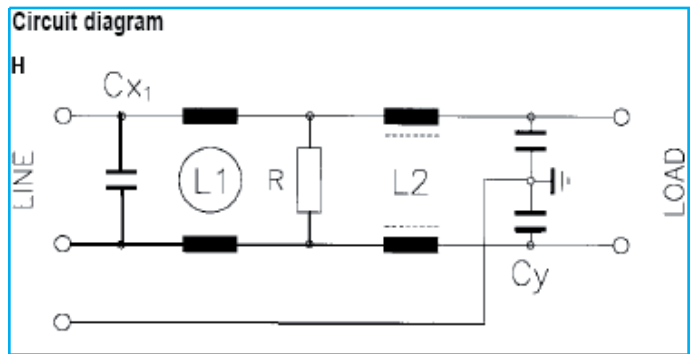

Insertion loss (typical):

Asymmetrical (line to ground) - - - Symmetrical (line to line)

FAI

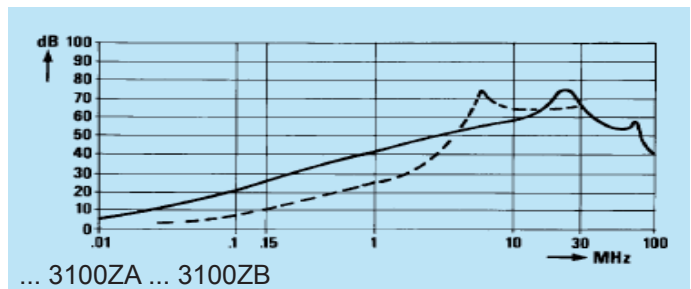
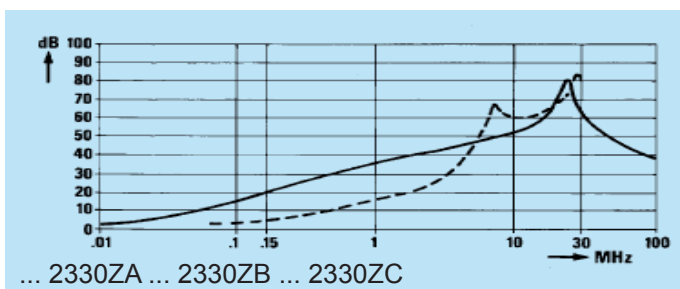
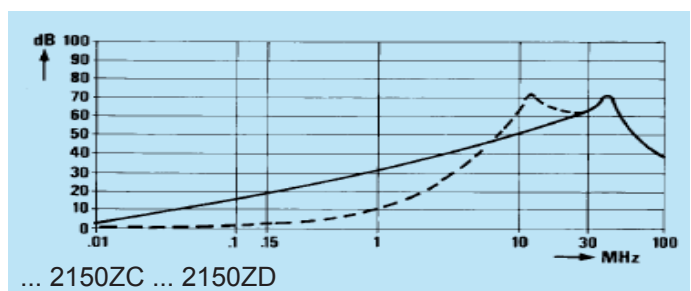
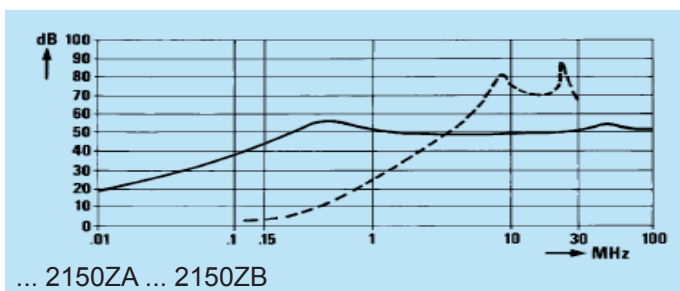

Approvals



Insertion loss (typical): — Asymmetrical (line to ground) - - - Symmetrical (line to line)

FAK

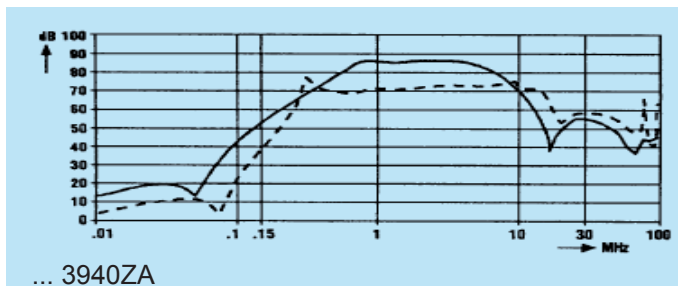
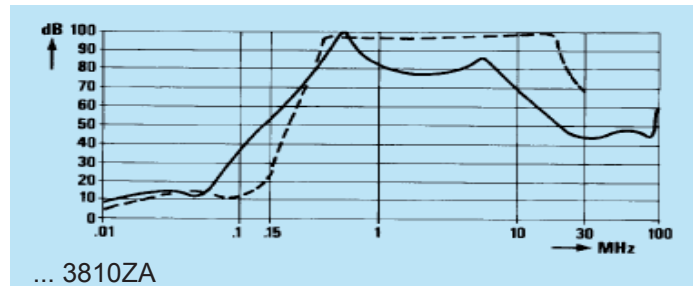
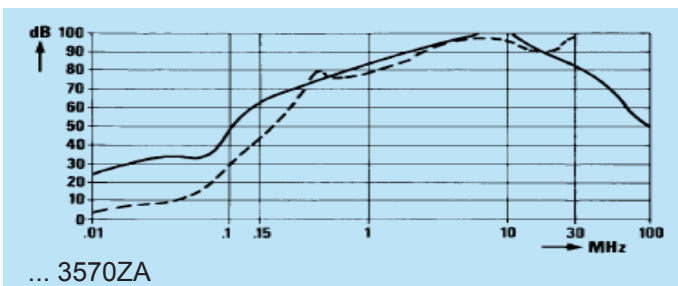
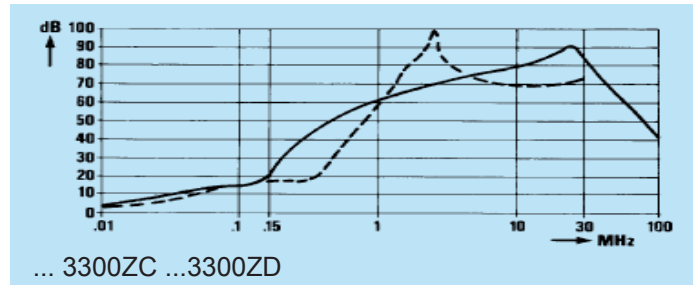
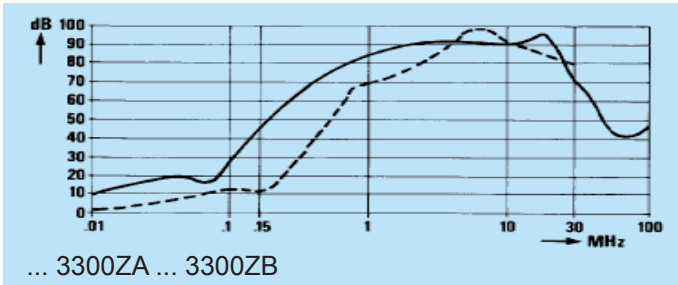

Insertion loss (typical): — Asymmetrical (line to ground) - - - Symmetrical (line to line)

FAM

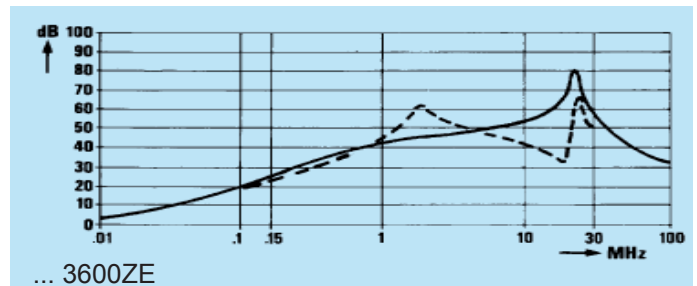
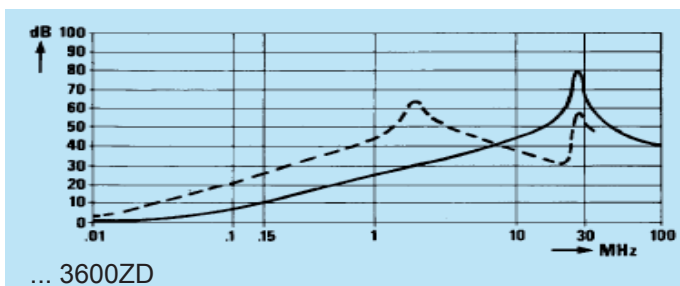
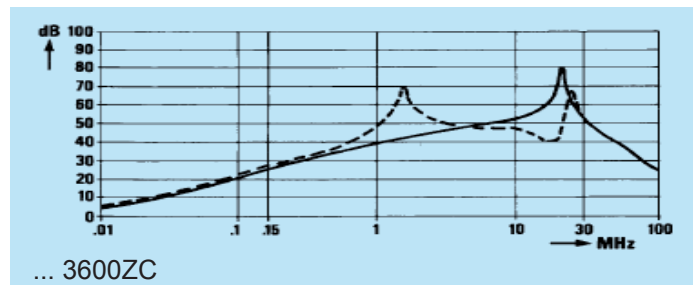
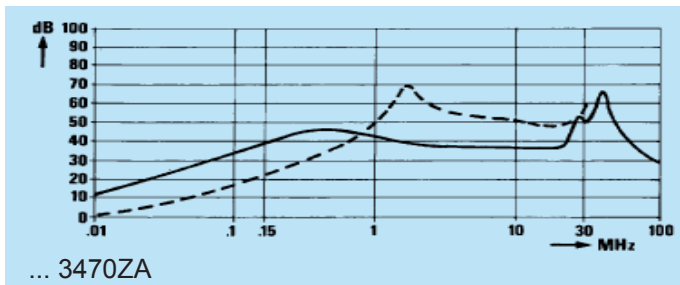
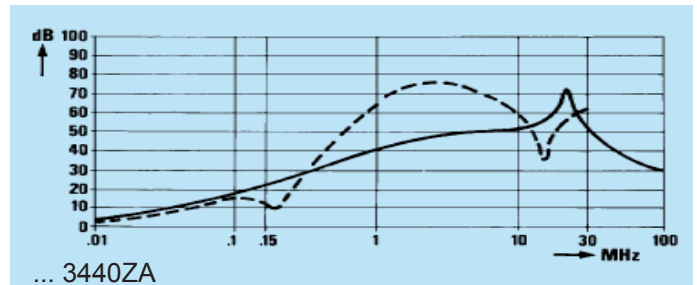
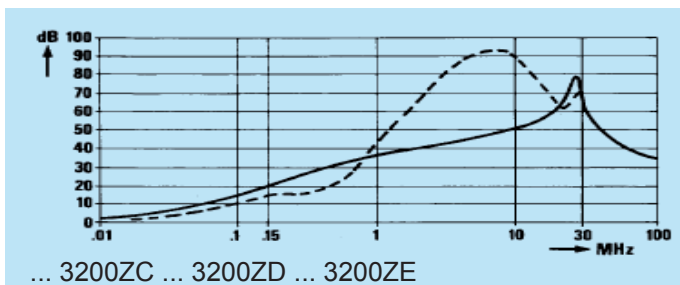
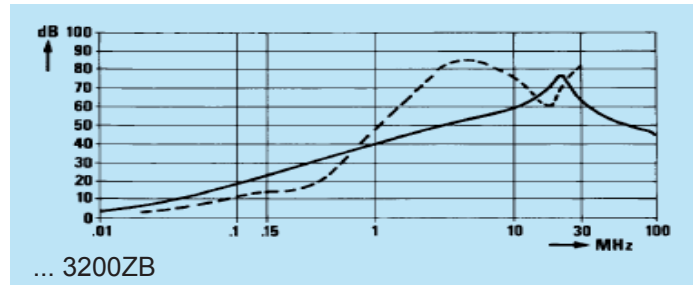
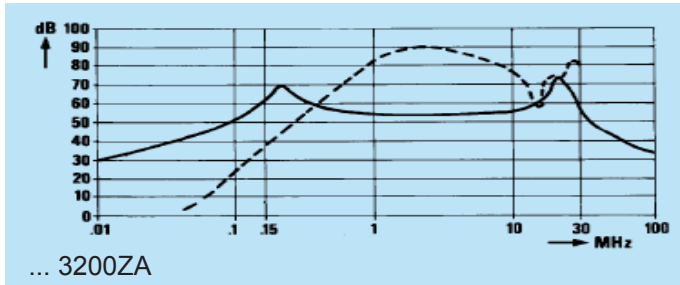

Insertion loss (typical): — Asymmetrical (line to ground) - - - Symmetrical (line to line)

FAM

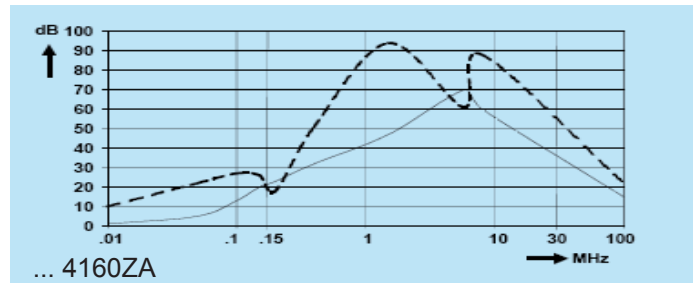
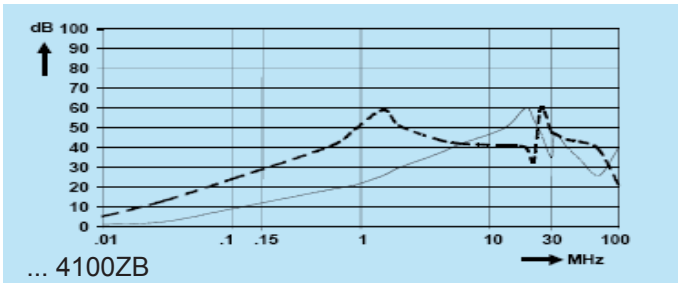
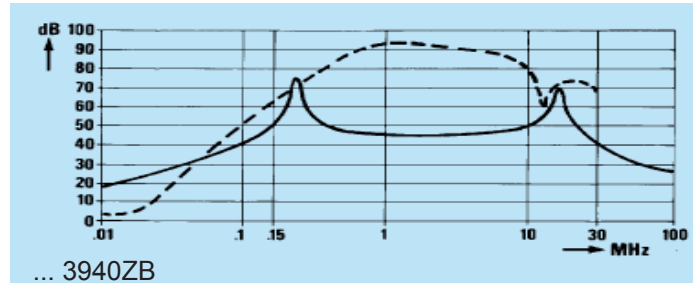
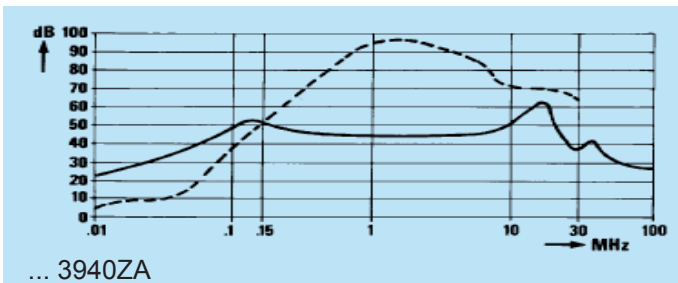
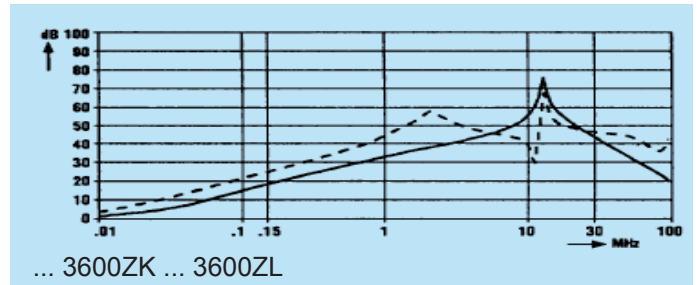
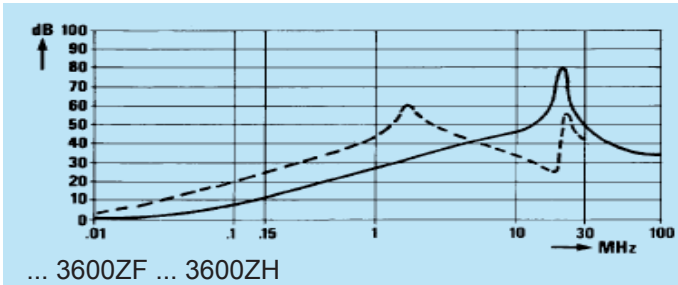

Insertion loss (typical): — Asymmetrical (line to ground) - - - Symmetrical (line to line)

FAR

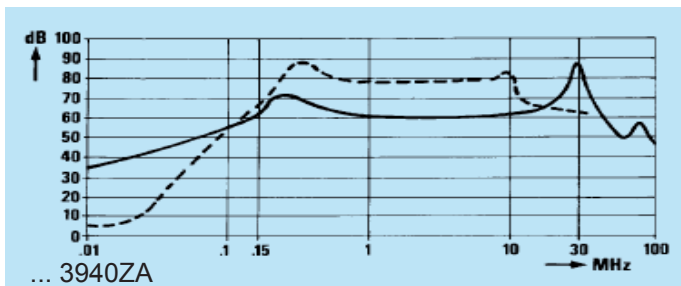
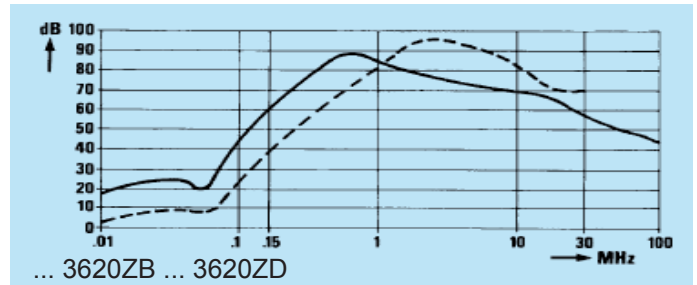
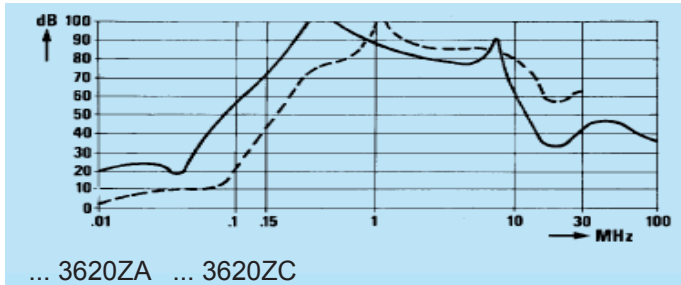

FAS

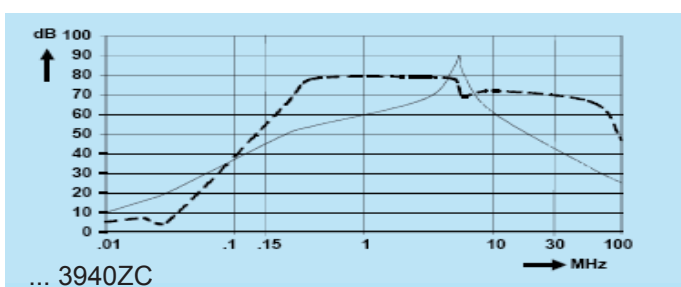
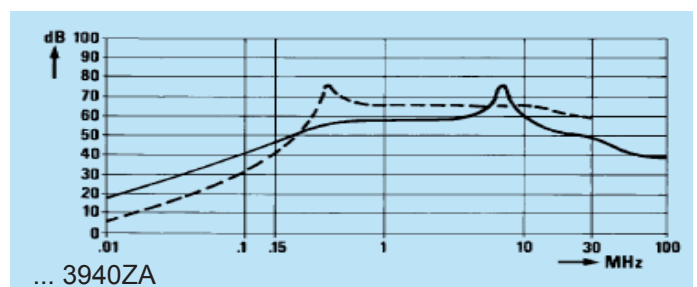
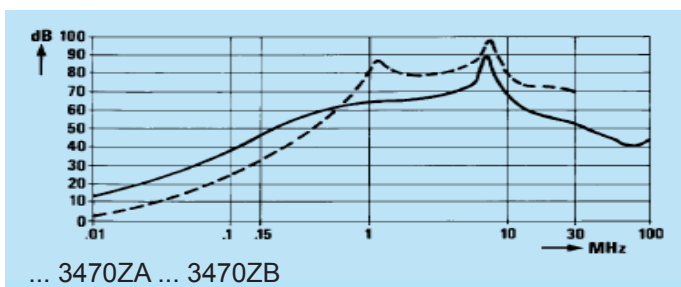
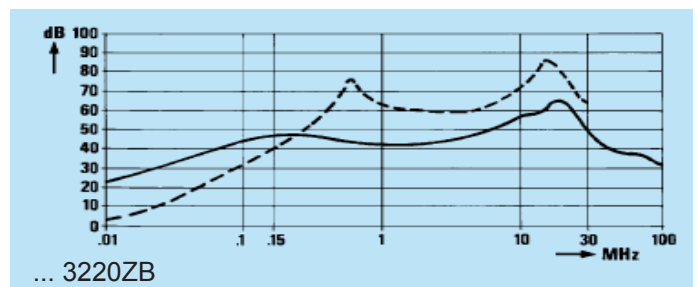
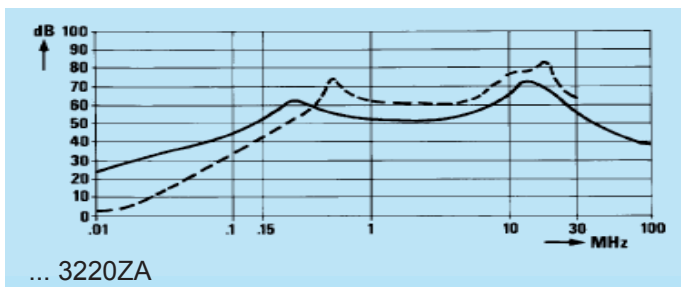



Компания «ЭлектроПласт» предлагает заключение долгосрочных отношений при поставках импортных электронных компонентов на взаимовыгодных условиях!

Наши преимущества:

- Оперативные поставки широкого спектра электронных компонентов отечественного и импортного производства напрямую от производителей и с крупнейших мировых складов;
- Поставка более 17-ти миллионов наименований электронных компонентов;
- Поставка сложных, дефицитных, либо снятых с производства позиций;
- Оперативные сроки поставки под заказ (от 5 рабочих дней);
- Экспресс доставка в любую точку России;
- Техническая поддержка проекта, помощь в подборе аналогов, поставка прототипов;
- Система менеджмента качества сертифицирована по Международному стандарту ISO 9001;
- Лицензия ФСБ на осуществление работ с использованием сведений, составляющих государственную тайну;
- Поставка специализированных компонентов (Xilinx, Altera, Analog Devices, Intersil, Interpoint, Microsemi, Aeroflex, Peregrine, Syfer, Eurofarad, Texas Instrument, Miteq, Cobham, E2V, MA-COM, Hittite, Mini-Circuits, General Dynamics и др.);

Помимо этого, одним из направлений компании «ЭлектроПласт» является направление «Источники питания». Мы предлагаем Вам помощь Конструкторского отдела:

- Подбор оптимального решения, техническое обоснование при выборе компонента;
- Подбор аналогов;
- Консультации по применению компонента;
- Поставка образцов и прототипов;
- Техническая поддержка проекта;
- Защита от снятия компонента с производства.



Как с нами связаться

Телефон: 8 (812) 309 58 32 (многоканальный)

Факс: 8 (812) 320-02-42

Электронная почта: org@eplast1.ru

Адрес: 198099, г. Санкт-Петербург, ул. Калинина, дом 2, корпус 4, литера А.