

FEATURES

Low power

2.3 mA maximum supply current

Low noise

3.2 nV/ $\sqrt{\text{Hz}}$ maximum input voltage noise at 1 kHz

200 fA/ $\sqrt{\text{Hz}}$ current noise at 1 kHz

Excellent ac specifications

10 MHz bandwidth ($G = 1$)

2 MHz bandwidth ($G = 100$)

0.6 μs settling time to 0.001% ($G = 10$)

80 dB CMRR at 20 kHz ($G = 1$)

35 V/ μs slew rate

High precision dc performance (AD8421BRZ)

94 dB CMRR minimum ($G = 1$)

0.2 $\mu\text{V}/^\circ\text{C}$ maximum input offset voltage drift

1 ppm/ $^\circ\text{C}$ maximum gain drift ($G = 1$)

500 pA maximum input bias current

Inputs protected to 40 V from opposite supply

± 2.5 V to ± 18 V dual supply (5 V to 36 V single supply)

Gain set with a single resistor ($G = 1$ to 10,000)

APPLICATIONS

Medical instrumentation

Precision data acquisition

Microphone preamplification

Vibration analysis

Multiplexed input applications

ADC driver

GENERAL DESCRIPTION

The **AD8421** is a low cost, low power, extremely low noise, ultralow bias current, high speed instrumentation amplifier that is ideally suited for a broad spectrum of signal conditioning and data acquisition applications. This product features extremely high CMRR, allowing it to extract low level signals in the presence of high frequency common-mode noise over a wide temperature range.

The 10 MHz bandwidth, 35 V/ μs slew rate, and 0.6 μs settling time to 0.001% ($G = 10$) allow the **AD8421** to amplify high speed signals and excel in applications that require high channel count, multiplexed systems. Even at higher gains, the current feedback architecture maintains high performance; for example, at $G = 100$, the bandwidth is 2 MHz and the settling time is 0.8 μs . The **AD8421** has excellent distortion performance, making it suitable for use in demanding applications such as vibration analysis.

Rev. 0

Information furnished by Analog Devices is believed to be accurate and reliable. However, no responsibility is assumed by Analog Devices for its use, nor for any infringements of patents or other rights of third parties that may result from its use. Specifications subject to change without notice. No license is granted by implication or otherwise under any patent or patent rights of Analog Devices. Trademarks and registered trademarks are the property of their respective owners.

PIN CONNECTION DIAGRAM



Figure 1.

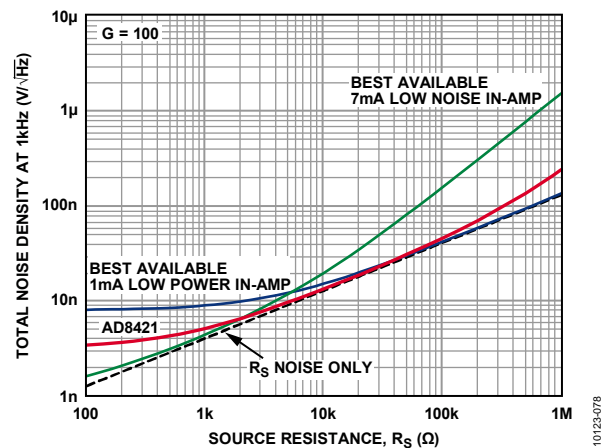

Figure 2. Noise Density vs. Source Resistance

The **AD8421** delivers 3 nV/ $\sqrt{\text{Hz}}$ input voltage noise and 200 fA/ $\sqrt{\text{Hz}}$ current noise with only 2 mA quiescent current, making it an ideal choice for measuring low level signals. For applications with high source impedance, the **AD8421** employs innovative process technology and design techniques to provide noise performance that is limited only by the sensor.

The **AD8421** uses unique protection methods to ensure robust inputs while still maintaining very low noise. This protection allows input voltages up to 40 V from the opposite supply rail without damage to the part.

A single resistor sets the gain from 1 to 10,000. The reference pin can be used to apply a precise offset to the output voltage.

The **AD8421** is specified from -40°C to $+85^\circ\text{C}$ and has typical performance curves to 125°C . It is available in 8-lead MSOP and SOIC packages.

TABLE OF CONTENTS

| | | | |
|---|----|--|----|
| Features | 1 | Gain Selection | 20 |
| Applications | 1 | Reference Terminal | 21 |
| Pin Connection Diagram | 1 | Input Voltage Range | 21 |
| General Description | 1 | Layout | 21 |
| Revision History | 2 | Input Bias Current Return Path | 22 |
| Specifications | 3 | Input Voltages Beyond the Supply Rails | 22 |
| AR and BR Grades | 3 | Radio Frequency Interference (RFI) | 23 |
| ARM and BRM Grades | 5 | Calculating the Noise of the Input Stage | 23 |
| Absolute Maximum Ratings | 8 | Applications Information | 25 |
| Thermal Resistance | 8 | Differential Output Configuration | 25 |
| ESD Caution | 8 | Driving an ADC | 26 |
| Pin Configuration and Function Descriptions | 9 | Outline Dimensions | 27 |
| Typical Performance Characteristics | 10 | Ordering Guide | 27 |
| Theory of Operation | 20 | | |
| Architecture | 20 | | |

REVISION HISTORY

5/12—Revision 0: Initial Version

SPECIFICATIONS

$V_S = \pm 15\text{ V}$, $V_{REF} = 0\text{ V}$, $T_A = 25^\circ\text{C}$, $G = 1$, $R_L = 2\text{ k}\Omega$, unless otherwise noted.

AR AND BR GRADES

Table 1.

| Parameter | Test Conditions/ Comments | AR Grade | | | BR Grade | | | Unit |
|---|--|----------|------|------|----------|------|------|------------------------------|
| | | Min | Typ | Max | Min | Typ | Max | |
| COMMON-MODE REJECTION RATIO (CMRR) | | | | | | | | |
| CMRR DC to 60 Hz with 1 k Ω Source Imbalance | $V_{CM} = -10\text{ V to }+10\text{ V}$ | | | | | | | |
| G = 1 | | 86 | | | 94 | | | dB |
| G = 10 | | 106 | | | 114 | | | dB |
| G = 100 | | 126 | | | 134 | | | dB |
| G = 1000 | | 136 | | | 140 | | | dB |
| Over Temperature, G = 1 | $T = -40^\circ\text{C to }+85^\circ\text{C}$ | 80 | | | 93 | | | dB |
| CMRR at 20 kHz | | | | | | | | |
| G = 1 | $V_{CM} = -10\text{ V to }+10\text{ V}$ | 80 | | | 80 | | | dB |
| G = 10 | | 90 | | | 100 | | | dB |
| G = 100 | | 100 | | | 110 | | | dB |
| G = 1000 | | 110 | | | 120 | | | dB |
| NOISE | | | | | | | | |
| Voltage Noise, 1 kHz ¹ | $V_{IN+}, V_{IN-} = 0\text{ V}$ | | | | | | | |
| Input Voltage Noise, e_{ni} | | | 3 | 3.2 | | 3 | 3.2 | nV/ $\sqrt{\text{Hz}}$ |
| Output Voltage Noise, e_{no} | | | | 60 | | | 60 | nV/ $\sqrt{\text{Hz}}$ |
| Peak to Peak, RTI | $f = 0.1\text{ Hz to }10\text{ Hz}$ | | | | | | | |
| G = 1 | | | 2 | | | 2 | 2.2 | $\mu\text{V p-p}$ |
| G = 10 | | | 0.5 | | | 0.5 | | $\mu\text{V p-p}$ |
| G = 100 to 1000 | | | 0.07 | | | 0.07 | 0.09 | $\mu\text{V p-p}$ |
| Current Noise | | | | | | | | |
| Spectral Density | $f = 1\text{ kHz}$ | | 200 | | | 200 | | fA/ $\sqrt{\text{Hz}}$ |
| Peak to Peak, RTI | $f = 0.1\text{ Hz to }10\text{ Hz}$ | | 18 | | | 18 | | pA p-p |
| VOLTAGE OFFSET² | | | | | | | | |
| Input Offset Voltage, V_{OSI} | $V_S = \pm 5\text{ V to } \pm 15\text{ V}$ | | | 60 | | | 25 | μV |
| Over Temperature | $T_A = -40^\circ\text{C to }+85^\circ\text{C}$ | | | 86 | | | 45 | μV |
| Average TC | | | | 0.4 | | | 0.2 | $\mu\text{V}/^\circ\text{C}$ |
| Output Offset Voltage, V_{OSO} | | | | 350 | | | 250 | μV |
| Over Temperature | $T_A = -40^\circ\text{C to }+85^\circ\text{C}$ | | | 0.66 | | | 0.45 | mV |
| Average TC | | | | 6 | | | 5 | $\mu\text{V}/^\circ\text{C}$ |
| Offset RTI vs. Supply (PSR) | $V_S = \pm 2.5\text{ V to } \pm 18\text{ V}$ | | | | | | | |
| G = 1 | | 90 | 120 | | 100 | 120 | | dB |
| G = 10 | | 110 | 120 | | 120 | 140 | | dB |
| G = 100 | | 124 | 130 | | 140 | 150 | | dB |
| G = 1000 | | 130 | 140 | | 140 | 150 | | dB |
| INPUT CURRENT | | | | | | | | |
| Input Bias Current | | | 1 | 2 | | 0.1 | 0.5 | nA |
| Over Temperature | $T_A = -40^\circ\text{C to }+85^\circ\text{C}$ | | | 8 | | | 6 | nA |
| Average TC | | | 50 | | | 50 | | pA/ $^\circ\text{C}$ |
| Input Offset Current | | | 0.5 | 2 | | 0.1 | 0.5 | nA |
| Over Temperature | $T_A = -40^\circ\text{C to }+85^\circ\text{C}$ | | | 2.2 | | | 0.8 | nA |
| Average TC | | | 1 | | | 1 | | pA/ $^\circ\text{C}$ |

| Parameter | Test Conditions/ Comments | AR Grade | | | BR Grade | | | Unit | |
|--|--|---|-------|----------------|--------------|-------|----------------|--------|-----|
| | | Min | Typ | Max | Min | Typ | Max | | |
| DYNAMIC RESPONSE | | | | | | | | | |
| Small Signal Bandwidth | -3 dB | | | | | | | | |
| G = 1 | | | 10 | | | 10 | | MHz | |
| G = 10 | | | | 10 | | | 10 | MHz | |
| G = 100 | | | | 2 | | | 2 | MHz | |
| G = 1000 | | | 0.2 | | | 0.2 | MHz | | |
| Settling Time to 0.01% | 10 V step | | | | | | | | |
| G = 1 | | | 0.7 | | | 0.7 | | μs | |
| G = 10 | | | | 0.4 | | | 0.4 | μs | |
| G = 100 | | | | 0.6 | | | 0.6 | μs | |
| G = 1000 | | | 5 | | | 5 | μs | | |
| Settling Time to 0.001% | 10 V step | | | | | | | | |
| G = 1 | | | 1 | | | 1 | | μs | |
| G = 10 | | | | 0.6 | | | 0.6 | μs | |
| G = 100 | | | | 0.8 | | | 0.8 | μs | |
| G = 1000 | | | 6 | | | 6 | μs | | |
| Slew Rate | | | | | | | | | |
| G = 1 to 100 | | | 35 | | | 35 | | V/μs | |
| GAIN³ | | | | | | | | | |
| Gain Range | $G = 1 + (9.9 \text{ k}\Omega/R_G)$ | 1 | | 10,000 | 1 | | 10,000 | V/V | |
| Gain Error | $V_{OUT} = \pm 10 \text{ V}$ | | | 0.02 | | | 0.01 | % | |
| G = 10 to 1000 | | | | | 0.2 | | | 0.1 | % |
| Gain Nonlinearity | $V_{OUT} = -10 \text{ V to } +10 \text{ V}$ $R_L \geq 2 \text{ k}\Omega$ | | | 1 | | | 1 | ppm | |
| G = 1 | | | | 1 | | 1 | 3 | ppm | |
| G = 10 to 1000 | | $R_L \geq 600 \Omega$ | | 30 | 50 | | 30 | 50 | ppm |
| G = 10 to 1000 | | $V_{OUT} = -5 \text{ V to } +5 \text{ V}$ | | 5 | 10 | | 5 | 10 | ppm |
| Gain vs. Temperature ³ | | | | 5 | | 0.1 | 1 | ppm/°C | |
| G > 1 | | | | -50 | | | -50 | ppm/°C | |
| INPUT | | | | | | | | | |
| Input Impedance | | | | | | | | | |
| Differential | | | 30 3 | | | 30 3 | | GΩ pF | |
| Common Mode | | | 30 3 | | | 30 3 | | GΩ pF | |
| Input Operating Voltage Range ⁴ | $V_S = \pm 2.5 \text{ V to } \pm 18 \text{ V}$ $T_A = -40^\circ\text{C}$ $T_A = +85^\circ\text{C}$ | $-V_S + 2.3$ | | $+V_S - 1.8$ | $-V_S + 2.3$ | | $+V_S - 1.8$ | V | |
| Over Temperature | | $-V_S + 2.5$ | | $+V_S - 2.0$ | $-V_S + 2.5$ | | $+V_S - 2.0$ | V | |
| Over Temperature | | $-V_S + 2.1$ | | $+V_S - 1.8$ | $-V_S + 2.1$ | | $+V_S - 1.8$ | V | |
| OUTPUT | | | | | | | | | |
| Output Swing | $R_L = 2 \text{ k}\Omega$ $V_S = \pm 2.5 \text{ V to } \pm 18 \text{ V}$ $T_A = -40^\circ\text{C to } +85^\circ\text{C}$ | $-V_S + 1.2$ | | $+V_S - 1.6$ | $-V_S + 1.2$ | | $+V_S - 1.6$ | V | |
| Over Temperature | | $-V_S + 1.2$ | | $+V_S - 1.6$ | $-V_S + 1.2$ | | $+V_S - 1.6$ | V | |
| Short-Circuit Current | | | 65 | | | 65 | | mA | |
| REFERENCE INPUT | | | | | | | | | |
| R_{IN} | $V_{IN+}, V_{IN-} = 0 \text{ V}$ | | 20 | | | 20 | | kΩ | |
| I_{IN} | | | 20 | 24 | | 20 | 24 | μA | |
| Voltage Range | | $-V_S$ | | $+V_S$ | $-V_S$ | | $+V_S$ | V | |
| Reference Gain to Output | | | | 1 ± 0.0001 | | | 1 ± 0.0001 | V/V | |

| Parameter | Test Conditions/ Comments | AR Grade | | | BR Grade | | | Unit |
|---------------------------|---------------------------------|----------|-----|------|----------|-----|------|------|
| | | Min | Typ | Max | Min | Typ | Max | |
| POWER SUPPLY | | | | | | | | |
| Operating Range | Dual supply | ±2.5 | | ±18 | ±2.5 | | ±18 | V |
| | Single supply | 5 | | 36 | 5 | | 36 | V |
| Quiescent Current | | | 2 | 2.3 | | 2 | 2.3 | mA |
| Over Temperature | T _A = -40°C to +85°C | | | 2.6 | | | 2.6 | mA |
| TEMPERATURE RANGE | | | | | | | | |
| For Specified Performance | | -40 | | +85 | -40 | | +85 | °C |
| Operational ⁵ | | -40 | | +125 | -40 | | +125 | °C |

¹ Total voltage noise = $\sqrt{(e_{ni}^2 + (e_{no}/G)^2 + e_{RG}^2)}$. See the Theory of Operation section for more information.

² Total RTI $V_{OS} = (V_{OSI}) + (V_{OSO}/G)$.

³ These specifications do not include the tolerance of the external gain setting resistor, R_G. For G > 1, add R_G errors to the specifications given in this table.

⁴ Input voltage range of the AD8421 input stage only. The input range can depend on the common-mode voltage, differential voltage, gain, and reference voltage. See the Input Voltage Range section for more details.

⁵ See the Typical Performance Characteristics section for expected operation between 85°C and 125°C.

ARM AND BRM GRADES

Table 2.

| Parameter | Test Conditions/ Comments | ARM Grade | | | BRM Grade | | | Unit |
|---|---|-----------|------|-----|-----------|------|------|------------------------------|
| | | Min | Typ | Max | Min | Typ | Max | |
| COMMON-MODE REJECTION RATIO (CMRR) | | | | | | | | |
| CMRR DC to 60 Hz with 1 k Ω Source Imbalance | V _{CM} = -10 V to +10 V | | | | | | | |
| G = 1 | | 84 | | | 92 | | | dB |
| G = 10 | | 104 | | | 112 | | | dB |
| G = 100 | | 124 | | | 132 | | | dB |
| G = 1000 | | 134 | | | 140 | | | dB |
| Over Temperature, G = 1 | T _A = -40°C to +85°C | 80 | | | 90 | | | dB |
| CMRR at 20 kHz | V _{CM} = -10 V to +10 V | | | | | | | |
| G = 1 | | 80 | | | 80 | | | dB |
| G = 10 | | 90 | | | 90 | | | dB |
| G = 100 | | 100 | | | 100 | | | dB |
| G = 1000 | | 100 | | | 100 | | | dB |
| NOISE | | | | | | | | |
| Voltage Noise, 1 kHz ¹ | V _{IN+} , V _{IN-} = 0 V | | | | | | | |
| Input Voltage Noise, e _{ni} | | | 3 | 3.2 | | 3 | 3.2 | nV/ $\sqrt{\text{Hz}}$ |
| Output Voltage Noise, e _{no} | | | | 60 | | | 60 | nV/ $\sqrt{\text{Hz}}$ |
| Peak to Peak, RTI | f = 0.1 Hz to 10 Hz | | | | | | | |
| G = 1 | | | 2 | | | 2 | 2.2 | $\mu\text{V p-p}$ |
| G = 10 | | | 0.5 | | | 0.5 | | $\mu\text{V p-p}$ |
| G = 100 to 1000 | | | 0.07 | | | 0.07 | 0.09 | $\mu\text{V p-p}$ |
| Current Noise | | | | | | | | |
| Spectral Density | f = 1 kHz | | 200 | | | 200 | | fA/ $\sqrt{\text{Hz}}$ |
| Peak to Peak, RTI | f = 0.1 Hz to 10 Hz | | 18 | | | 18 | | pA p-p |
| VOLTAGE OFFSET ² | | | | | | | | |
| Input Offset Voltage, V _{OSI} | V _S = ±5 V to ±15 V | | | 70 | | | 50 | μV |
| Over Temperature | T _A = -40°C to +85°C | | | 135 | | | 135 | μV |
| Average TC | | | | 0.9 | | | 0.9 | $\mu\text{V}/^\circ\text{C}$ |
| Output Offset Voltage, V _{OSO} | | | | 600 | | | 400 | μV |
| Over Temperature | T _A = -40°C to +85°C | | | 1 | | | 1 | mV |
| Average TC | | | | 9 | | | 9 | $\mu\text{V}/^\circ\text{C}$ |

| Parameter | Test Conditions/ Comments | ARM Grade | | | BRM Grade | | | Unit | |
|--|---|------------------------------|-------|--------------|--------------|-------|--------------|--------|-----|
| | | Min | Typ | Max | Min | Typ | Max | | |
| Offset RTI vs. Supply (PSR) | $V_S = \pm 2.5 \text{ V to } \pm 18 \text{ V}$ | | | | | | | | |
| G = 1 | | 90 | 120 | | 100 | 120 | | dB | |
| G = 10 | | 110 | 120 | | 120 | 140 | | dB | |
| G = 100 | | 124 | 130 | | 140 | 150 | | dB | |
| G = 1000 | 130 | 140 | | 140 | 150 | | dB | | |
| INPUT CURRENT | | | | | | | | | |
| Input Bias Current | $T_A = -40^\circ\text{C to } +85^\circ\text{C}$ | | 1 | 2 | | 0.1 | 1 | nA | |
| Over Temperature | | | | 8 | | | 6 | nA | |
| Average TC | | | | 50 | | | 50 | pA/°C | |
| Input Offset Current | $T_A = -40^\circ\text{C to } +85^\circ\text{C}$ | | 0.5 | 2 | | 0.1 | 1 | nA | |
| Over Temperature | | | | 3 | | | 1.5 | nA | |
| Average TC | | | | 1 | | | 1 | pA/°C | |
| DYNAMIC RESPONSE | | | | | | | | | |
| Small Signal Bandwidth | -3 dB | | | | | | | | |
| G = 1 | | | 10 | | | 10 | | MHz | |
| G = 10 | | | 10 | | | 10 | | MHz | |
| G = 100 | | | 2 | | | 2 | | MHz | |
| G = 1000 | | 0.2 | | | 0.2 | | MHz | | |
| Settling Time 0.01% | 10 V step | | | | | | | | |
| G = 1 | | | 0.7 | | | 0.7 | | μs | |
| G = 10 | | | 0.4 | | | 0.4 | | μs | |
| G = 100 | | | 0.6 | | | 0.6 | | μs | |
| G = 1000 | | 5 | | | 5 | | μs | | |
| Settling Time 0.001% | 10 V step | | | | | | | | |
| G = 1 | | | 1 | | | 1 | | μs | |
| G = 10 | | | 0.6 | | | 0.6 | | μs | |
| G = 100 | | | 0.8 | | | 0.8 | | μs | |
| G = 1000 | | 6 | | | 6 | | μs | | |
| Slew Rate | | | | | | | | | |
| G = 1 to 100 | | | 35 | | | 35 | | V/μs | |
| GAIN ³ | $G = 1 + (9.9 \text{ k}\Omega/R_G)$ | | | | | | | | |
| Gain Range | | 1 | | 10,000 | 1 | | 10,000 | V/V | |
| Gain Error | $V_{OUT} = \pm 10 \text{ V}$ | | | | | | | | |
| G = 1 | | | | 0.05 | | | 0.02 | % | |
| G = 10 to 1000 | | | | 0.3 | | 0.2 | % | | |
| Gain Nonlinearity | $V_{OUT} = -10 \text{ V to } +10 \text{ V}$ | | | | | | | | |
| G = 1 | | $R_L \geq 2 \text{ k}\Omega$ | | 1 | | | 1 | ppm | |
| | | $R_L = 600 \Omega$ | | 1 | 3 | | 1 | 3 | ppm |
| G = 10 to 1000 | | $R_L \geq 600 \Omega$ | | 30 | 50 | | 30 | 50 | ppm |
| | $V_{OUT} = -5 \text{ V to } +5 \text{ V}$ | | 5 | 10 | | 5 | 10 | ppm | |
| Gain vs. Temperature ³ | | | | | | | | | |
| G = 1 | | | | 5 | | 0.1 | 1 | ppm/°C | |
| G > 1 | | | | -50 | | | -50 | ppm/°C | |
| INPUT | | | | | | | | | |
| Input Impedance | | | | | | | | | |
| Differential | | | 30 3 | | | 30 3 | | GΩ pF | |
| Common Mode | | | 30 3 | | | 30 3 | | GΩ pF | |
| Input Operating Voltage Range ⁴ | $V_S = \pm 2.5 \text{ V to } \pm 18 \text{ V}$ | $-V_S + 2.3$ | | $+V_S - 1.8$ | $-V_S + 2.3$ | | $+V_S - 1.8$ | V | |
| Over Temperature | $T_A = -40^\circ\text{C}$ | $-V_S + 2.5$ | | $+V_S - 2.0$ | $-V_S + 2.5$ | | $+V_S - 2.0$ | V | |
| | $T_A = +85^\circ\text{C}$ | $-V_S + 2.1$ | | $+V_S - 1.8$ | $-V_S + 2.1$ | | $+V_S - 1.8$ | V | |

| Parameter | Test Conditions/ Comments | ARM Grade | | | BRM Grade | | | Unit |
|---------------------------|---|--------------|----------------|--------------|--------------|----------------|--------------|------------------|
| | | Min | Typ | Max | Min | Typ | Max | |
| OUTPUT | $R_L = 2\text{ k}\Omega$ | | | | | | | |
| Output Swing | $V_S = \pm 2.5\text{ V to } \pm 18\text{ V}$ | $-V_S + 1.2$ | | $+V_S - 1.6$ | $-V_S + 1.2$ | | $+V_S - 1.6$ | V |
| Over Temperature | $T_A = -40^\circ\text{C to } +85^\circ\text{C}$ | $-V_S + 1.2$ | | $+V_S - 1.6$ | $-V_S + 1.2$ | | $+V_S - 1.6$ | V |
| Short-Circuit Current | | | 65 | | | 65 | | mA |
| REFERENCE INPUT | | | | | | | | |
| R_{IN} | | | 20 | | | 20 | | k Ω |
| I_{IN} | $V_{IN+}, V_{IN-} = 0\text{ V}$ | | 20 | 24 | | 20 | 24 | μA |
| Voltage Range | | $-V_S$ | | $+V_S$ | $-V_S$ | | $+V_S$ | V |
| Reference Gain to Output | | | 1 ± 0.0001 | | | 1 ± 0.0001 | | V/V |
| POWER SUPPLY | | | | | | | | |
| Operating Range | Dual supply | ± 2.5 | | ± 18 | ± 2.5 | | ± 18 | V |
| | Single supply | 5 | | 36 | 5 | | 36 | V |
| Quiescent Current | | | 2 | 2.3 | | 2 | 2.3 | mA |
| Over Temperature | $T_A = -40^\circ\text{C to } +85^\circ\text{C}$ | | | 2.6 | | | 2.6 | mA |
| TEMPERATURE RANGE | | | | | | | | |
| For Specified Performance | | -40 | | $+85$ | -40 | | $+85$ | $^\circ\text{C}$ |
| Operational ⁵ | | -40 | | $+125$ | -40 | | $+125$ | $^\circ\text{C}$ |

¹ Total voltage noise = $\sqrt{(e_{n1})^2 + (e_{no}/G)^2 + e_{RG}^2}$. See the Theory of Operation section for more information.

² Total RTI $V_{OS} = (V_{OS1}) + (V_{OS0}/G)$.

³ These specifications do not include the tolerance of the external gain setting resistor, R_G . For $G > 1$, add R_G errors to the specifications given in this table.

⁴ Input voltage range of the AD8421 input stage only. The input range can depend on the common-mode voltage, differential voltage, gain, and reference voltage. See the Input Voltage Range section for more information.

⁵ See the Typical Performance Characteristics section for expected operation between 85°C and 125°C .

ABSOLUTE MAXIMUM RATINGS

Table 3.

| Parameter | Rating |
|--|-------------------------|
| Supply Voltage | ±18 V |
| Output Short-Circuit Current Duration | Indefinite |
| Maximum Voltage at –IN or +IN ¹ | –V _S + 40 V |
| Minimum Voltage at –IN or +IN | +V _S – 40 V |
| Maximum Voltage at REF ² | +V _S + 0.3 V |
| Minimum Voltage at REF | –V _S – 0.3 V |
| Storage Temperature Range | –65°C to +150°C |
| Operating Temperature Range | –40°C to +125°C |
| Maximum Junction Temperature | 150°C |
| ESD | |
| Human Body Model | 2 kV |
| Charged Device Model | 1.25 kV |
| Machine Model | 0.2 kV |

¹ For voltages beyond these limits, use input protection resistors. See the Theory of Operation section for more information.

² There are ESD protection diodes from the reference input to each supply, so REF cannot be driven beyond the supplies in the same way that +IN and –IN can. See the Reference Terminal section for more information.

Stresses above those listed under Absolute Maximum Ratings may cause permanent damage to the device. This is a stress rating only; functional operation of the device at these or any other conditions above those indicated in the operational section of this specification is not implied. Exposure to absolute maximum rating conditions for extended periods may affect device reliability.

THERMAL RESISTANCE

θ_{JA} is specified for a device in free air using a 4-layer JEDEC printed circuit board (PCB).

Table 4.

| Package | θ_{JA} | Unit |
|-------------|---------------|------|
| 8-Lead SOIC | 107.8 | °C/W |
| 8-Lead MSOP | 138.6 | °C/W |

ESD CAUTION



ESD (electrostatic discharge) sensitive device. Charged devices and circuit boards can discharge without detection. Although this product features patented or proprietary protection circuitry, damage may occur on devices subjected to high energy ESD. Therefore, proper ESD precautions should be taken to avoid performance degradation or loss of functionality.

PIN CONFIGURATION AND FUNCTION DESCRIPTIONS



Figure 3. Pin Configuration

Table 5. Pin Function Descriptions

| Pin No. | Mnemonic | Description |
|---------|------------------|--|
| 1 | -IN | Negative Input Terminal. |
| 2, 3 | R _G | Gain Setting Terminals. Place resistor across the R _G pins to set the gain. $G = 1 + (9.9 \text{ k}\Omega/R_G)$. |
| 4 | +IN | Positive Input Terminal. |
| 5 | -V _S | Negative Power Supply Terminal. |
| 6 | REF | Reference Voltage Terminal. Drive this terminal with a low impedance voltage source to level shift the output. |
| 7 | V _{OUT} | Output Terminal. |
| 8 | +V _S | Positive Power Supply Terminal. |

TYPICAL PERFORMANCE CHARACTERISTICS

T_A = 25°C, V_S = ±15 V, V_{REF} = 0 V, R_L = 2 kΩ, unless otherwise noted.



Figure 4. Typical Distribution of Input Offset Voltage

10123-003

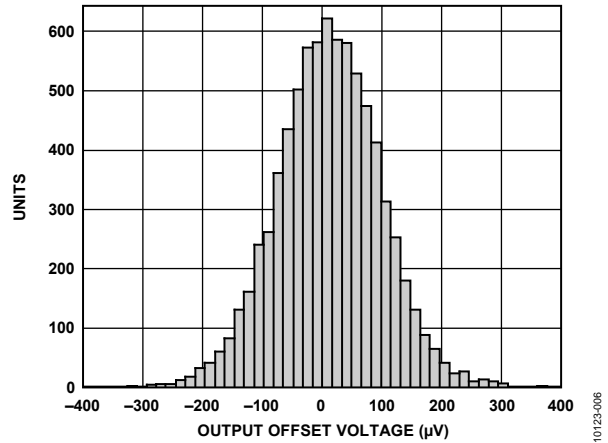

Figure 7. Typical Distribution of Output Offset Voltage

10123-006

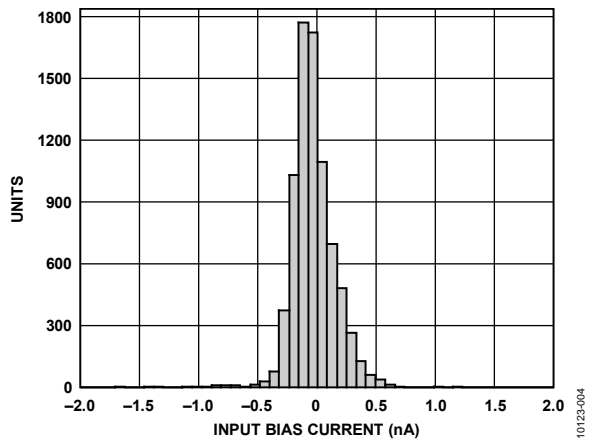

Figure 5. Typical Distribution of Input Bias Current

10123-004

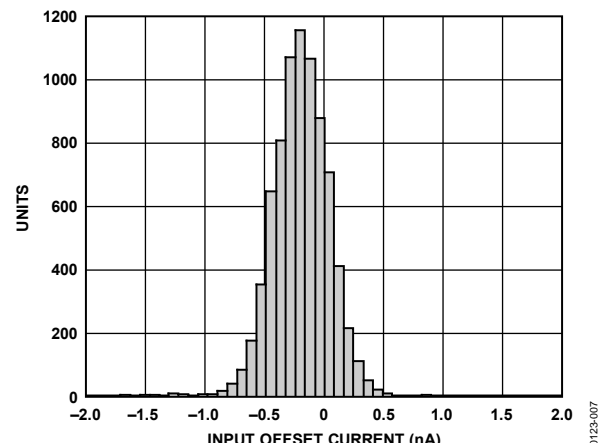

Figure 8. Typical Distribution of Input Offset Current

10123-007

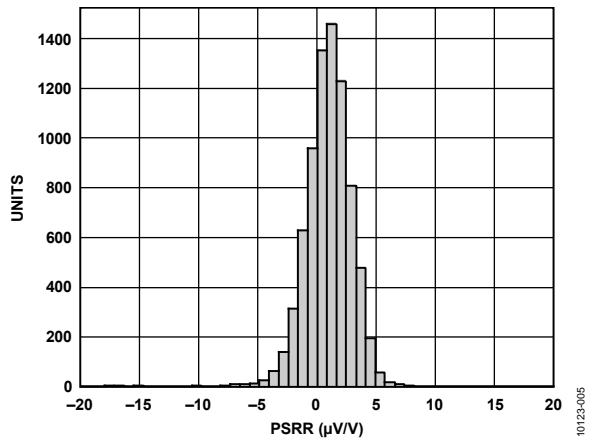

Figure 6. Typical Distribution of PSRR (G = 1)

10123-005

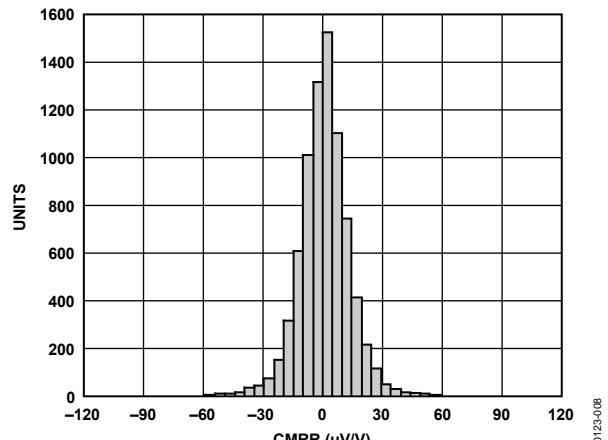

Figure 9. Typical Distribution of CMRR (G = 1)

10123-008



Figure 10. Input Common-Mode Voltage vs. Output Voltage; V_S = ±12V and ±15V (G = 1)



Figure 13. Input Common-Mode Voltage vs. Output Voltage; V_S = ±2.5V and ±5V (G = 100)



Figure 11. Input Common-Mode Voltage vs. Output Voltage; V_S = ±2.5V and ±5V (G = 1)



Figure 14. Input Overvoltage Performance; G = 1, +V_S = 5V, -V_S = 0V



Figure 12. Input Common-Mode Voltage vs. Output Voltage; V_S = ±12V and ±15V (G = 100)



Figure 15. Input Overvoltage Performance; G = 1, V_S = ±15V



Figure 16. Input Overvoltage Performance; $+V_S = 5V$, $-V_S = 0V$, $G = 100$

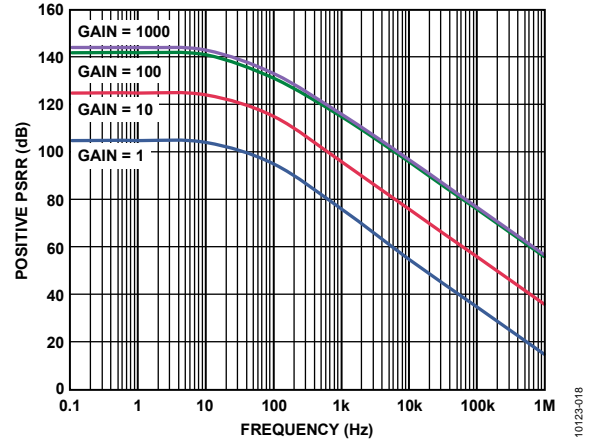

Figure 19. Positive PSRR vs. Frequency



Figure 17. Input Overvoltage Performance; $V_S = \pm 15V$, $G = 100$

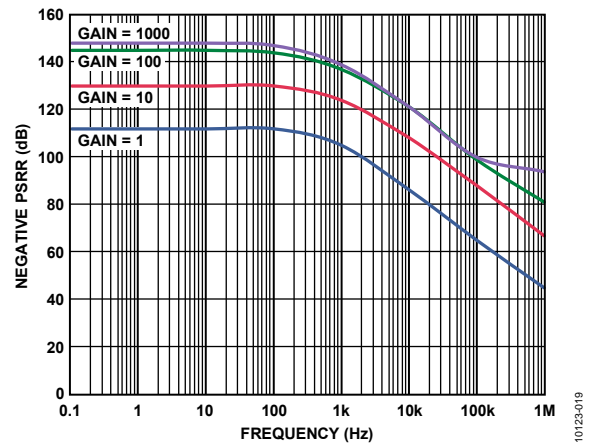

Figure 20. Negative PSRR vs. Frequency



Figure 18. Input Bias Current vs. Common-Mode Voltage

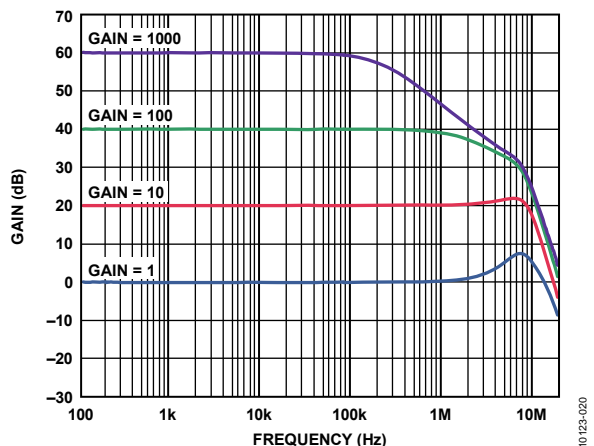

Figure 21. Gain vs. Frequency

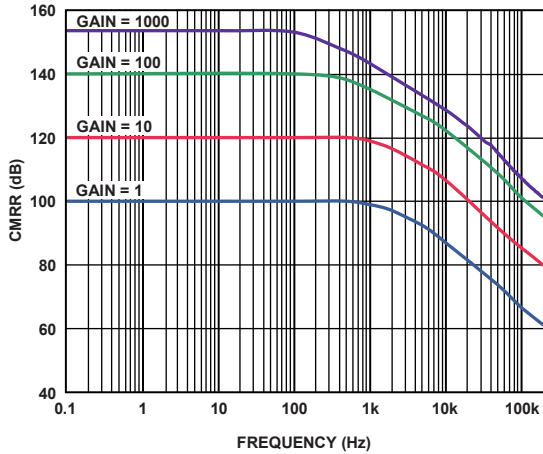

Figure 22. CMRR vs. Frequency

10123-021



Figure 25. Input Bias Current vs. Temperature

10123-024

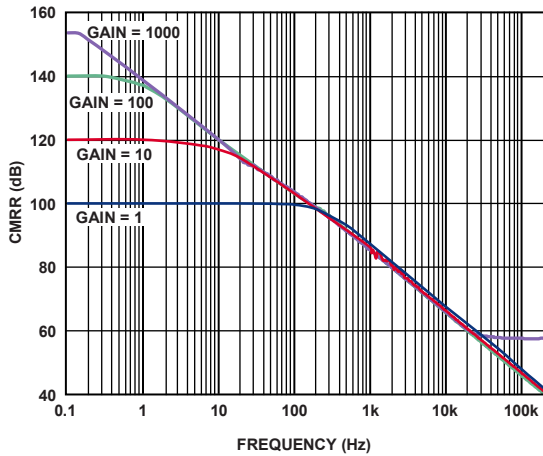

Figure 23. CMRR vs. Frequency, 1 kΩ Source Imbalance

10123-022



Figure 26. Gain vs. Temperature (G = 1)

10123-025

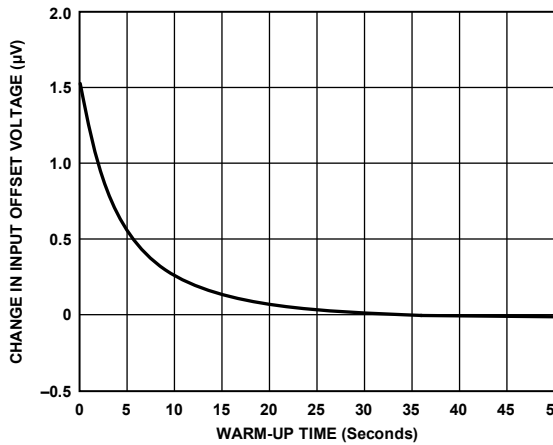

Figure 24. Change in Input Offset Voltage (V_{OS}) vs. Warm-Up Time

10123-023



Figure 27. CMRR vs. Temperature (G = 1)

10123-074



Figure 28. Supply Current vs. Temperature ($G = 1$)

10123-026

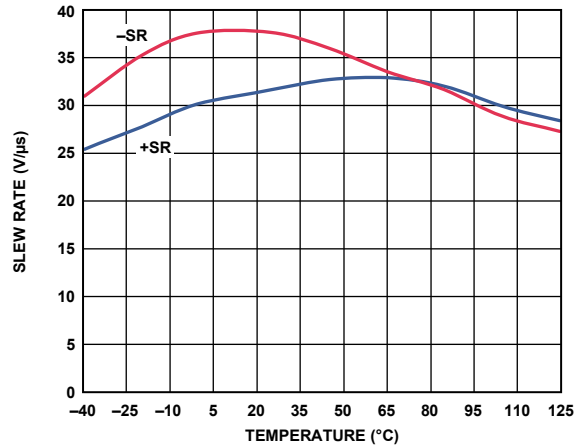

Figure 31. Slew Rate vs. Temperature, $V_S = \pm 5 V$ ($G = 1$)

10123-028



Figure 29. Short-Circuit Current vs. Temperature ($G = 1$)

10123-027

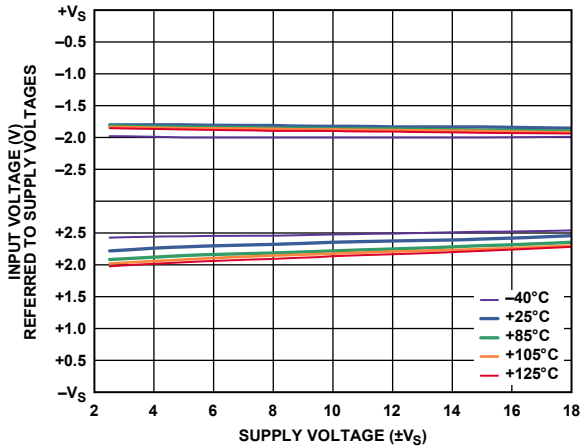

Figure 32. Input Voltage Limit vs. Supply Voltage

10123-030



Figure 30. Slew Rate vs. Temperature, $V_S = \pm 15 V$ ($G = 1$)

10123-028

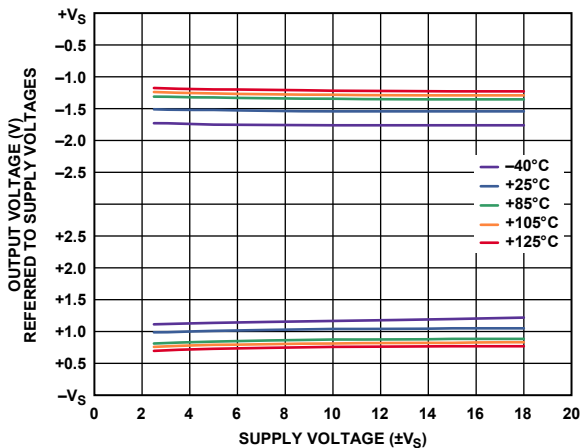

Figure 33. Output Voltage Swing vs. Supply Voltage, $R_L = 10 k\Omega$

10123-031



Figure 34. Output Voltage Swing vs. Supply Voltage, $R_L = 600\ \Omega$

10123-032

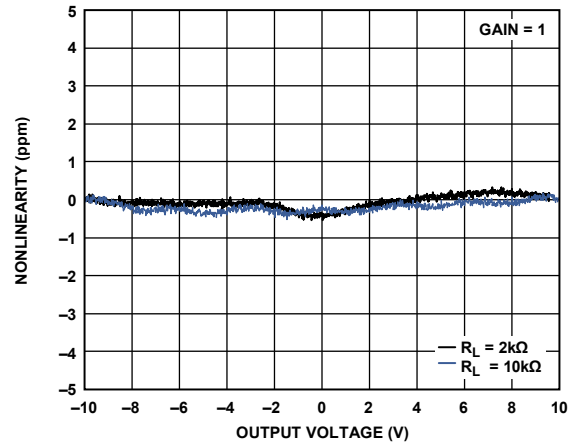

Figure 37. Gain Nonlinearity ($G = 1$), $R_L = 10\ \text{k}\Omega$, $2\ \text{k}\Omega$

10123-035



Figure 35. Output Voltage Swing vs. Load Resistance

10123-033

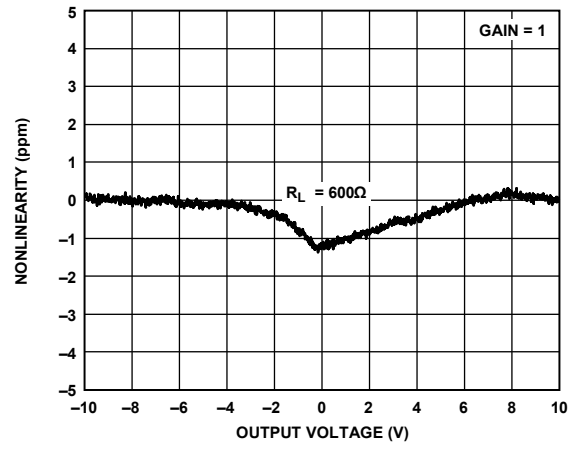

Figure 38. Gain Nonlinearity ($G = 1$), $R_L = 600\ \Omega$

10123-036

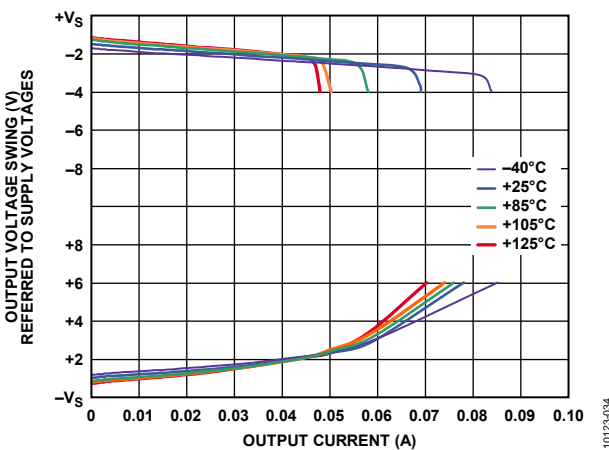

Figure 36. Output Voltage Swing vs. Output Current

10123-034

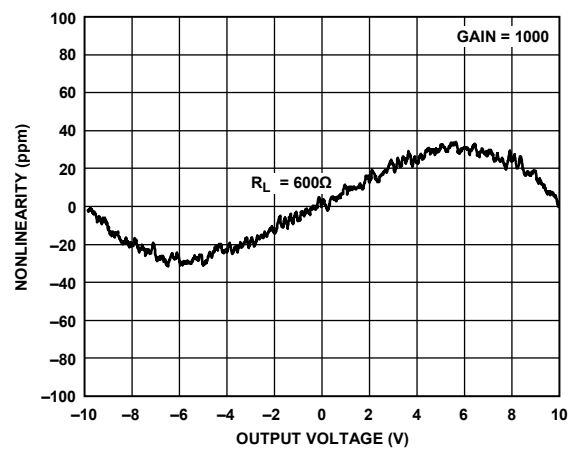

Figure 39. Gain Nonlinearity ($G = 1000$), $R_L = 600\ \Omega$, $V_{OUT} = \pm 10\ \text{V}$

10123-072

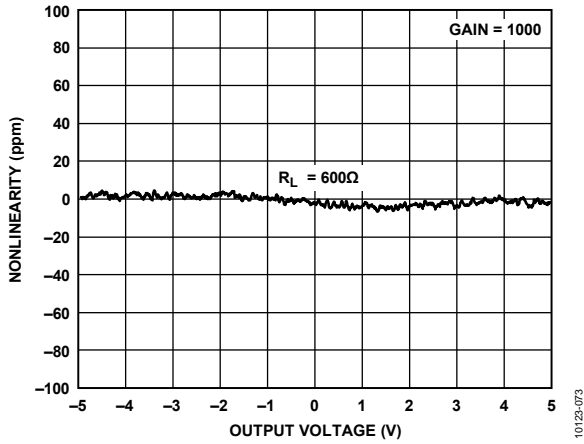

Figure 40. Gain Nonlinearity ($G = 1000$), $R_L = 600\ \Omega$, $V_{OUT} = \pm 5\ V$

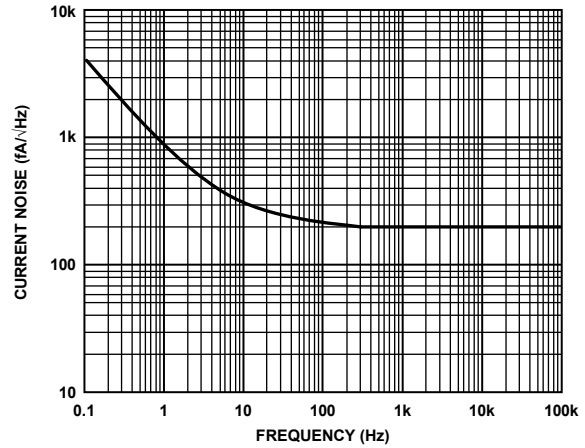

Figure 43. Current Noise Spectral Density vs. Frequency

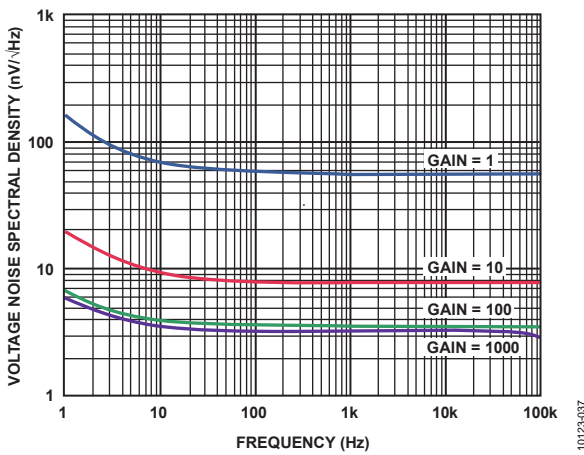

Figure 41. RTI Voltage Noise Spectral Density vs. Frequency



Figure 44. 0.1 Hz to 10 Hz Current Noise

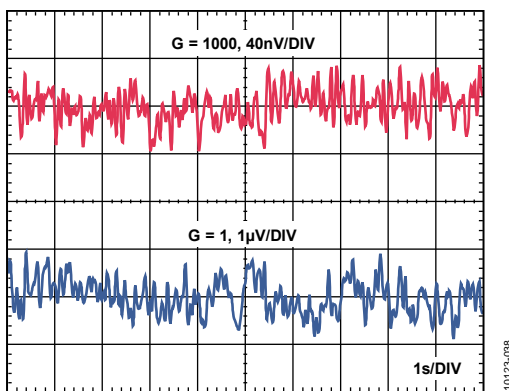

Figure 42. 0.1 Hz to 10 Hz RTI Voltage Noise ($G = 1$, $G = 1000$)



Figure 45. Large Signal Frequency Response



Figure 46. Large Signal Pulse Response and Settling Time ($G = 1$), 10 V Step, $V_S = \pm 15$ V, $R_L = 2$ k Ω , $C_L = 100$ pF

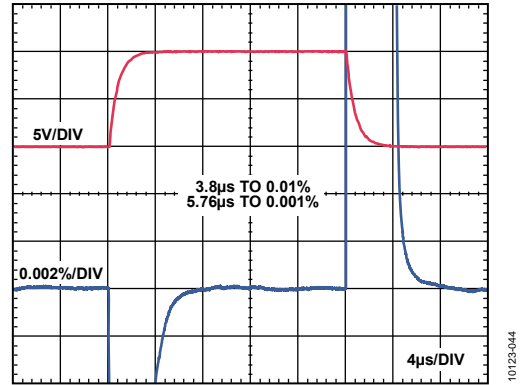

Figure 49. Large Signal Pulse Response and Settling Time ($G = 1000$), 10 V Step, $V_S = \pm 15$ V, $R_L = 2$ k Ω , $C_L = 100$ pF



Figure 47. Large Signal Pulse Response and Settling Time ($G = 10$), 10 V Step, $V_S = \pm 15$ V, $R_L = 2$ k Ω , $C_L = 100$ pF



Figure 50. Settling Time vs. Step Size ($G = 1$), $R_L = 2$ k Ω , $C_L = 100$ pF

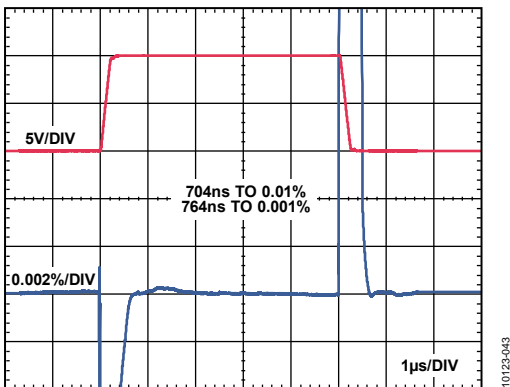

Figure 48. Large Signal Pulse Response and Settling Time ($G = 100$), 10 V Step, $V_S = \pm 15$ V, $R_L = 2$ k Ω , $C_L = 100$ pF

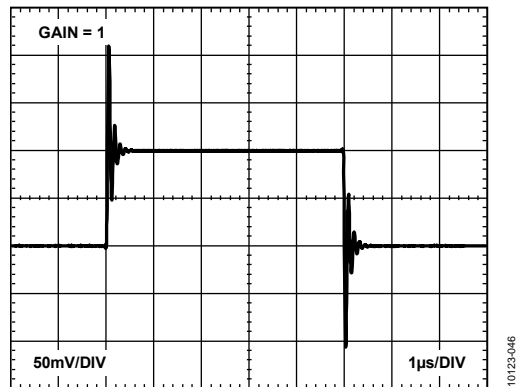
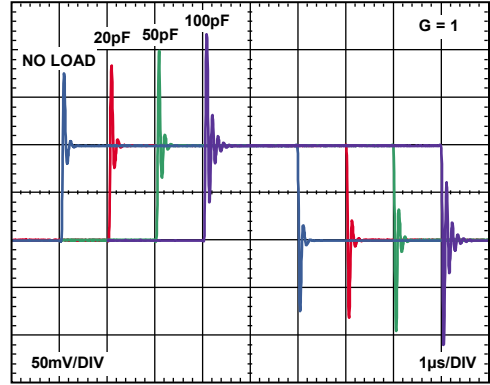

Figure 51. Small Signal Pulse Response ($G = 1$), $R_L = 600$ Ω , $C_L = 100$ pF



10123-047

Figure 52. Small Signal Pulse Response ($G = 10$), $R_L = 600\ \Omega$, $C_L = 100\ \text{pF}$



10123-053

Figure 55. Small Signal Response with Various Capacitive Loads ($G = 1$), $R_L = \text{Infinity}$

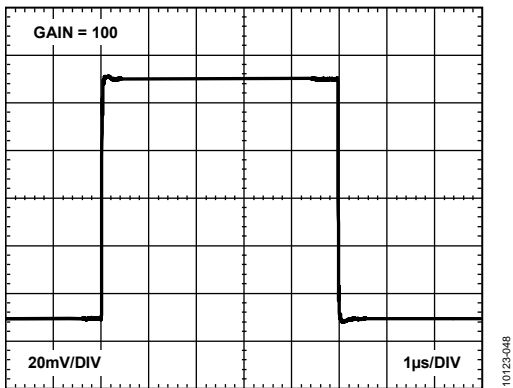

10123-048

Figure 53. Small Signal Pulse Response ($G = 100$), $R_L = 600\ \Omega$, $C_L = 100\ \text{pF}$

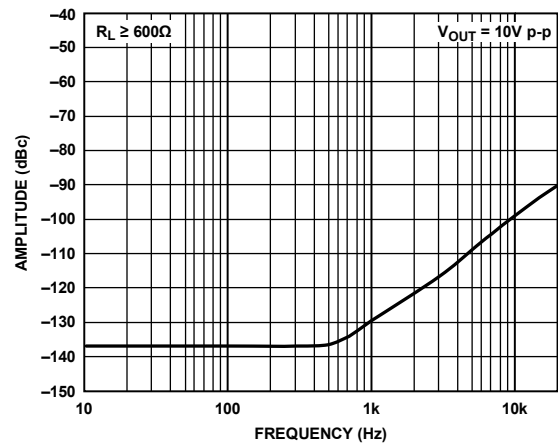

10123-055

Figure 56. Second Harmonic Distortion vs. Frequency ($G = 1$)

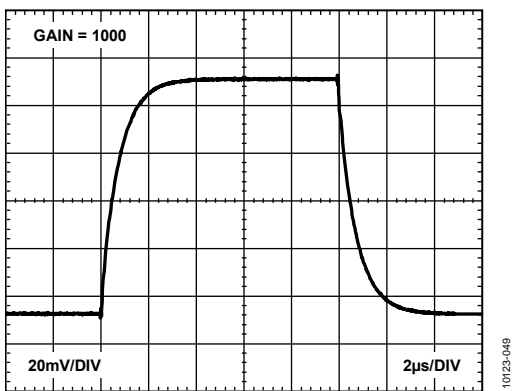

10123-049

Figure 54. Small Signal Pulse Response ($G = 1000$), $R_L = 600\ \Omega$, $C_L = 100\ \text{pF}$

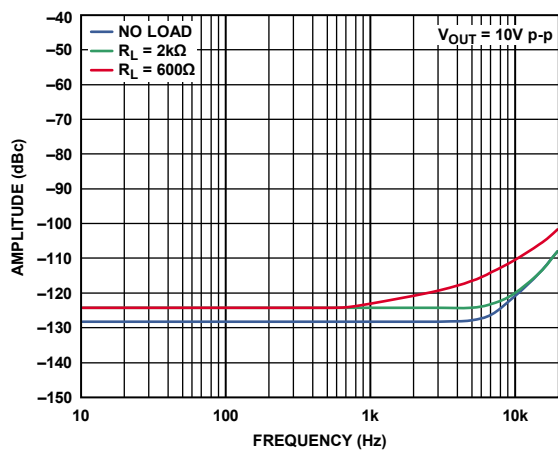

10123-056

Figure 57. Third Harmonic Distortion vs. Frequency ($G = 1$)



Figure 58. Second Harmonic Distortion vs. Frequency (G = 1000)



Figure 60. THD vs. Frequency



Figure 59. Third Harmonic Distortion vs. Frequency (G = 1000)

THEORY OF OPERATION



Figure 61. Simplified Schematic

ARCHITECTURE

The [AD8421](#) is based on the classic 3-op-amp topology. This topology has two stages: a preamplifier to provide differential amplification, followed by a difference amplifier that removes the common-mode voltage. Figure 61 shows a simplified schematic of the [AD8421](#).

Topologically, Q1, A1, R1 and Q2, A2, R2 can be viewed as precision current feedback amplifiers. Input Transistors Q1 and Q2 are biased at a fixed current so that any input signal forces the output voltages of A1 and A2 to change accordingly. The differential signal applied to the inputs is replicated across the R_G pins. Any current through R_G also flows through R1 and R2, creating a gained differential voltage between Node 1 and Node 2.

The amplified differential and common-mode signals are applied to a difference amplifier that rejects the common-mode voltage but preserves the amplified differential voltage. The difference amplifier employs innovations that result in very low output errors such as offset voltage and drift, distortion at various loads, as well as output noise. Laser-trimmed resistors allow for a highly accurate in-amp with gain error less than 0.01% and CMRR that exceeds 94 dB ($G = 1$). The high performance pinout and special attention given to design and layout allow for high CMRR performance across a wide frequency and temperature range.

Using superbeta input transistors and bias current compensation, the [AD8421](#) offers extremely high input impedance, low bias current, low offset current, low current noise, and extremely low voltage noise of $3 \text{ nV}/\sqrt{\text{Hz}}$. The current-limiting and overvoltage protection scheme allow the input to go 40 V from the opposite rail at all gains without compromising the noise performance.

The transfer function of the [AD8421](#) is

$$V_{OUT} = G \times (V_{+IN} - V_{-IN}) + V_{REF}$$

$$\text{where } G = 1 + \frac{9.9 \text{ k}\Omega}{R_G}$$

Users can easily and accurately set the gain using a single standard resistor.

GAIN SELECTION

Placing a resistor across the R_G terminals sets the gain of the [AD8421](#). The gain can be calculated by referring to Table 6 or by using the following gain equation:

$$R_G = \frac{9.9 \text{ k}\Omega}{G - 1}$$

The [AD8421](#) defaults to $G = 1$ when no gain resistor is used. To determine the total gain accuracy of the system, add the tolerance and gain drift of the R_G resistor to the specifications of the [AD8421](#). When the gain resistor is not used, gain error and gain drift are minimal.

Table 6. Gains Achieved Using 1% Resistors

| 1% Standard Table Value of R_G | Calculated Gain |
|----------------------------------|-----------------|
| 10 k Ω | 1.99 |
| 2.49 k Ω | 4.98 |
| 1.1 k Ω | 10.00 |
| 523 Ω | 19.93 |
| 200 Ω | 50.50 |
| 100 Ω | 100.0 |
| 49.9 Ω | 199.4 |
| 20 Ω | 496.0 |
| 10 Ω | 991.0 |
| 4.99 Ω | 1985 |

R_G Power Dissipation

The [AD8421](#) duplicates the differential voltage across its inputs onto the R_G resistor. Choose an R_G resistor size that is sufficient to handle the expected power dissipation at ambient temperature.

REFERENCE TERMINAL

The output voltage of the AD8421 is developed with respect to the potential on the reference terminal. This can be used to sense the ground at the load, thereby taking advantage of the CMRR to reject ground noise or to introduce a precise offset to the signal at the output. For example, a voltage source can be tied to the REF pin to level shift the output, allowing the AD8421 to drive a single-supply ADC. The REF pin is protected with ESD diodes and should not exceed either +V_S or -V_S by more than 0.3 V.

For best performance, maintain a source impedance to the REF terminal that is below 1 Ω. As shown in Figure 61, the reference terminal, REF, is at one end of a 10 kΩ resistor. Additional impedance at the REF terminal adds to this 10 kΩ resistor and results in amplification of the signal connected to the positive input. The amplification from the additional R_{REF} can be calculated as follows:

$$2(10\text{ k}\Omega + R_{REF})/(20\text{ k}\Omega + R_{REF})$$

Only the positive signal path is amplified; the negative path is unaffected. This uneven amplification degrades CMRR.



Figure 62. Driving the Reference Pin

INPUT VOLTAGE RANGE

The 3-op-amp architecture of the AD8421 applies gain in the first stage before removing the common-mode voltage in the difference amplifier stage. Internal nodes between the first and second stages (Node 1 and Node 2 in Figure 61) experience a combination of a gained signal, a common-mode signal, and a diode drop. The voltage supplies can limit the combined signal, even when the individual input and output signals are not limited. Figure 10 through Figure 13 show this limitation in detail.

LAYOUT

To ensure optimum performance of the AD8421 at the PCB level, care must be taken in the design of the board layout. The pins of the AD8421 are arranged in a logical manner to aid in this task.



Figure 63. Pin Configuration Diagram

Common-Mode Rejection Ratio over Frequency

Poor layout can cause some of the common-mode signals to be converted to differential signals before reaching the in-amp. Such conversions occur when one input path has a frequency response that is different from the other. To maintain high CMRR over frequency, closely match the input source impedance and capacitance of each path. Place additional source resistance in the input path (for example, input protection resistors) close to the in-amp inputs, to minimize the interaction of the resistance with parasitic capacitance from the PCB traces.

Parasitic capacitance at the gain setting pins (R_G) can also affect CMRR over frequency. If the board design has a component at the gain setting pins (for example, a switch or jumper), choose a component such that the parasitic capacitance is as small as possible.

Power Supplies and Grounding

Use a stable dc voltage to power the instrumentation amplifier. Noise on the supply pins can adversely affect performance.

Place a 0.1 μF capacitor as close as possible to each supply pin. Because the length of the bypass capacitor leads is critical at high frequency, surface-mount capacitors are recommended. Any parasitic inductance in the bypass ground trace works against the low impedance that is created by the bypass capacitor. As shown in Figure 64, a 10 μF capacitor can be used farther away from the device. For these larger value capacitors, which are intended to be effective at lower frequencies, the current return path distance is less critical. In most cases, the 10 μF capacitor can be shared by other local precision integrated circuits.



Figure 64. Supply Decoupling, REF, and Output Referred to Local Ground

A ground plane layer helps to reduce parasitic inductances, which minimizes voltage drops with changes in current. The area of the current path is directly proportional to the magnitude of parasitic inductances and, therefore, the impedance of the path at high frequency. Large changes in currents in an inductive decoupling path or ground return create unwanted effects due to the coupling of such changes into the amplifier inputs.

Because load currents flow from the supplies, the load should be connected at the same physical location as the bypass capacitor grounds.

Reference Pin

The output voltage of the AD8421 is developed with respect to the potential on the reference terminal. Ensure that REF is tied to the appropriate local ground.

INPUT BIAS CURRENT RETURN PATH

The input bias current of the AD8421 must have a return path to ground. When using a floating source without a current return path (such as a thermocouple), create a current return path as shown in Figure 65.



Figure 65. Creating an Input Bias Current Return Path

INPUT VOLTAGES BEYOND THE SUPPLY RAILS

The AD8421 has very robust inputs. It typically does not need additional input protection, as shown in Figure 66.



Figure 66. Typical Application; No Input Protection Required

The AD8421 inputs are current limited; therefore, input voltages can be up to 40 V from the opposite supply rail, with no input

protection required at all gains. For example, if +Vs = +5 V and -Vs = -8 V, the part can safely withstand voltages from -35 V to +32 V.

The remaining AD8421 terminals should be kept within the supplies. All terminals of the AD8421 are protected against ESD.

Input Voltages Beyond the Maximum Ratings

For applications where the AD8421 encounters voltages beyond the limits in the Absolute Maximum Ratings table, external protection is required. This external protection depends on the duration of the overvoltage event and the noise performance that is required.

For short-lived events, transient protectors (such as metal oxide varistors (MOVs)), may be all that is required.



Figure 67. Input Protection Options for Input Voltages Beyond Absolute Maximum Ratings

For longer events, use resistors in series with the inputs, combined with diodes. To avoid degrading bias current performance, low leakage diodes such as the BAV199 or FJH1100 are recommended. The diodes prevent the voltage at the input of the amplifier from exceeding the maximum ratings, and the resistors limit the current into the diodes. Because most external diodes can easily handle 100 mA or more, resistor values do not need to be large and, therefore, have a minimal impact on noise performance.

At the expense of some noise performance, another solution is to use series resistors. In the case of overvoltage, current into the AD8421 inputs is internally limited. Although the AD8421 inputs must be kept within the limits defined in the Absolute Maximum Ratings section, the I × R drop across the protection resistor increases the maximum voltage that the system can withstand, as follows:

For positive input signals

$$V_{MAX_NEW} = (40\text{ V} + \text{Negative Supply}) + I_{IN} \times R_{PROTECT}$$

For negative input signals

$$V_{MIN_NEW} = (\text{Positive Supply} - 40\text{ V}) - I_{OUT} \times R_{PROTECT}$$

Overvoltage performance is shown in Figure 14, Figure 15, Figure 16, and Figure 17. The AD8421 inputs can withstand a current of 40 mA at room temperature for at least a day. This time is cumulative over the life of the device. If long periods of overvoltage are expected, the use of an external protection method is recommended. Under extreme input conditions, the output of the amplifier may invert.

RADIO FREQUENCY INTERFERENCE (RFI)

RF rectification is often a problem when amplifiers are used in applications that have strong RF signals. The problem is intensified if long leads or PCB traces are required to connect the amplifier to the signal source. The disturbance can appear as a dc offset voltage or a train of pulses.

High frequency signals can be filtered with a low-pass filter network at the input of the instrumentation amplifier, as shown in Figure 68.



*CHIP FERRITE BEAD.

Figure 68. RFI Suppression

The choice of resistor and capacitor values depends on the desired trade-off between noise, input impedance at high frequencies, CMRR, signal bandwidth, and RFI immunity. An RC network limits both the differential and common-mode bandwidth, as shown in the following equations:

$$FilterFrequency_{DIFF} = \frac{1}{2\pi R(2C_D + C_C)}$$

$$FilterFrequency_{CM} = \frac{1}{2\pi RC_C}$$

where $C_D \geq 10 C_C$.

C_D affects the differential signal, and C_C affects the common-mode signal. A mismatch between $R \times C_C$ at the positive input and $R \times C_C$ at the negative input degrades the CMRR of the AD8421. By using a value of C_D that is one order of magnitude larger than C_C , the effect of the mismatch is reduced and CMRR performance is improved near the cutoff frequencies.

To achieve low noise and sufficient RFI filtering, the use of chip ferrite beads is recommended. Ferrite beads increase their impedance with frequency, thus leaving the signal of interest unaffected while preventing RF interference to reach the amplifier. They also help to eliminate the need for large resistor values in the filter, thus minimizing the system’s input-referred noise. The selection of the appropriate ferrite bead and capacitor values is a function of the interference frequency, input lead length, and RF power.

For best results, place the RFI filter network as close as possible to the amplifier. Layout is critical to ensure that RF signals are not picked up on the traces after the filter. If RF interference is too strong to be filtered sufficiently, shielding is recommended.

The resistors used for the RFI filter can be the same as those used for input protection.

CALCULATING THE NOISE OF THE INPUT STAGE

The total noise of the amplifier front end depends on much more than the 3.2 nV/√Hz specification of this data sheet. The three main contributors to noise are: the source resistance, the voltage noise of the instrumentation amplifier, and the current noise of the instrumentation amplifier.

In the following calculations, noise is referred to the input (RTI). In other words, all sources of noise are calculated as if the source appeared at the amplifier input. To calculate the noise referred to the amplifier output (RTO), multiply the RTI noise by the gain of the instrumentation amplifier.

Source Resistance Noise

Any sensor connected to the AD8421 has some output resistance. There may also be resistance placed in series with inputs for protection from either overvoltage or radio frequency interference. This combined resistance is labeled R1 and R2 in Figure 69. Any resistor, no matter how well made, has an intrinsic level of noise. This noise is proportional to the square root of the resistor value. At room temperature, the value is approximately equal to 4 nV/√Hz × √(resistor value in kΩ).

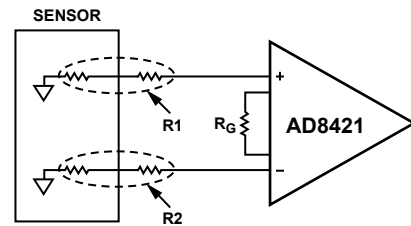

Figure 69. Source Resistance from Sensor and Protection Resistors

For example, assume that the combined sensor and protection resistance is 4 kΩ on the positive input and 1 kΩ on the negative input. Then the total noise from the input resistance is

$$\sqrt{(4 \times \sqrt{4})^2 + (4 \times \sqrt{1})^2} = \sqrt{64 + 16} = 8.9 \text{ nV}/\sqrt{\text{Hz}}$$

Voltage Noise of the Instrumentation Amplifier

The voltage noise of the instrumentation amplifier is calculated using three parameters: the device output noise, the input noise, and the R_G resistor noise. It is calculated as follows:

Total Voltage Noise =

$$\sqrt{(\text{Output Noise} / G)^2 + (\text{Input Noise})^2 + (\text{Noise of } R_G \text{ Resistor})^2}$$

For example, for a gain of 100, the gain resistor is 100 Ω . Therefore, the voltage noise of the in-amp is

$$\sqrt{(60/100)^2 + 3.2^2 + (4 \times \sqrt{0.1})^2} = 3.5 \text{ nV}/\sqrt{\text{Hz}}$$

Current Noise of the Instrumentation Amplifier

Current noise is converted to a voltage by the source resistance. The effect of current noise can be calculated by multiplying the specified current noise of the in-amp by the value of the source resistance.

For example, if the R1 source resistance in Figure 69 is 4 k Ω , and the R2 source resistance is 1 k Ω , the total effect from the current noise is calculated as follows:

$$\sqrt{(4 \times 0.2)^2 + (1 \times 0.2)^2} = 0.8 \text{ nV}/\sqrt{\text{Hz}}$$

Total Noise Density Calculation

To determine the total noise of the in-amp, referred to input, combine the source resistance noise, voltage noise, and current noise contribution by the sum of squares method.

For example, if the R1 source resistance in Figure 69 is 4 k Ω , the R2 source resistance is 1 k Ω , and the gain of the in-amp is 100, the total noise, referred to input, is

$$\sqrt{8.9^2 + 3.5^2 + 0.8^2} = 9.6 \text{ nV}/\sqrt{\text{Hz}}$$

APPLICATIONS INFORMATION

DIFFERENTIAL OUTPUT CONFIGURATION

Figure 70 shows an example of how to configure the [AD8421](#) for differential output.

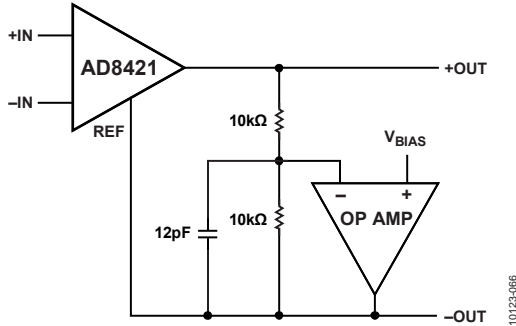

Figure 70. Differential Output Configuration with Op Amp

The differential output voltage is set by the following equation:

$$V_{DIFF_OUT} = V_{+OUT} - V_{-OUT} = Gain \times (V_{+IN} - V_{-IN})$$

The common-mode output is set by the following equation:

$$V_{CM_OUT} = (V_{+OUT} + V_{-OUT})/2 = V_{BIAS}$$

The advantage of this circuit is that the dc differential accuracy depends on the [AD8421](#), not on the op amp or the resistors. In addition, this circuit takes advantage of the precise control that the [AD8421](#) has of its output voltage relative to the reference voltage.

Although the dc performance and resistor matching of the op amp affect the dc common-mode output accuracy, such errors are likely to be rejected by the next device in the signal chain and, therefore, typically have little effect on overall system accuracy.

Because this circuit is susceptible to instability, a capacitor is included to limit the effective op amp bandwidth. This capacitor can be omitted if the amplifier pairing is stable.

The open-loop gain and phase of any amplifier may vary with process variation and temperature. Additional phase lag can be introduced by resistive or capacitive loading. To guarantee stability, the value of the capacitor in Figure 70 should be determined with a sample of circuits by evaluating the small signal pulse response of the circuit with load at the extremes of the output dynamic range.

The ambient temperature should also be varied over the expected range to evaluate its effect on stability. The voltage at +OUT may still have some overshoot after the circuit is tuned because the [AD8421](#) output amplifier responds faster than the op amp. A 12 pF capacitor is a good starting point.

For best large signal ac performance, use an op amp with a high slew rate to match the [AD8421](#) performance of 35 V/μs. High bandwidth is not essential because the system bandwidth is limited by the RC feedback. Some good choices for op amps are the [AD8610](#), [ADA4627-1](#), [AD8510](#), and the [ADA4898-1](#).

DRIVING AN ADC

The Class AB output stage, low noise and distortion, and high bandwidth and slew rate make the AD8421 a good choice for driving an ADC in a data acquisition system that requires front-end gain, high CMRR, and dc precision. Figure 71 shows the AD8421, in a gain-of-10 configuration, driving the AD7685, a 16-bit, 250 kSPS pseudodifferential SAR ADC. The RC low-pass filter that is shown between the AD8421 and the AD7685 has several purposes. It isolates the amplifier output from excessive loading from the dynamic ADC inputs, reduces the noise bandwidth of the amplifier, and provides overload protection for the AD7685 analog inputs. The filter cutoff can be determined empirically. To achieve the best ac performance, keep the impedance magnitude greater than 1 kΩ at the maximum input signal

frequency, and set the filter cutoff to settle to 1/2 LSB in one sampling period for a full-scale step. For additional considerations, refer to the data sheet of the ADC in use.

In a gain-of-10 configuration, the AD8421 has approximately 8 nV/√Hz voltage noise RTI (See the Calculating the Noise of the Input Stage section.) The front-end gain makes the system ten times more sensitive to input signals, with only a 7.5 dB reduction of SNR. The high current output and load regulation of the ADR435 allow the AD7685 to be powered directly from the reference without the need to provide another analog supply rail. The reference pin buffer may be any low power, unity-gain stable, dc precision op amp with less than approximately 25 nV/√Hz of wideband noise, such as the OP1177. Not all proper decoupling is shown in Figure 71. Take care to follow decoupling guidelines for both amplifiers and the ADR435.



Figure 71. AD8421 Driving an ADC



Figure 72. Typical Spectrum of the AD8421 (G = 10) Driving the AD7685

OUTLINE DIMENSIONS



COMPLIANT TO JEDEC STANDARDS MS-012-AA
 CONTROLLING DIMENSIONS ARE IN MILLIMETERS; INCH DIMENSIONS
 (IN PARENTHESES) ARE ROUNDED-OFF MILLIMETER EQUIVALENTS FOR
 REFERENCE ONLY AND ARE NOT APPROPRIATE FOR USE IN DESIGN.

Figure 73. 8-Lead Standard Small Outline Package [SOIC_N]
 Narrow Body
 (R-8)

Dimensions shown in millimeters and (inches)

012407-A



COMPLIANT TO JEDEC STANDARDS MO-187-AA

Figure 74. 8-Lead Mini Small Outline Package [MSOP]
 (RM-8)

Dimensions shown in millimeters

10-07-2009-B

ORDERING GUIDE

| Model ¹ | Temperature Range | Package Description | Package Option | Branding |
|--------------------|-------------------|--|----------------|----------|
| AD8421ARZ | -40°C to +85°C | 8-Lead SOIC_N, standard grade | R-8 | |
| AD8421ARZ-R7 | -40°C to +85°C | 8-Lead SOIC_N, standard grade, 7" Tape and Reel, | R-8 | |
| AD8421ARZ-RL | -40°C to +85°C | 8-Lead SOIC_N, standard grade, 13" Tape and Reel | R-8 | |
| AD8421BRZ | -40°C to +85°C | 8-Lead SOIC_N, high performance grade | R-8 | |
| AD8421BRZ-R7 | -40°C to +85°C | 8-Lead SOIC_N, high performance grade, 7" Tape and Reel | R-8 | |
| AD8421BRZ-RL | -40°C to +85°C | 8-Lead SOIC_N, high performance grade, 13" Tape and Reel | R-8 | |
| AD8421ARMZ | -40°C to +85°C | 8-Lead MSOP, standard grade | RM-8 | Y49 |
| AD8421ARMZ-R7 | -40°C to +85°C | 8-Lead MSOP, standard grade, 7" Tape and Reel | RM-8 | Y49 |
| AD8421ARMZ-RL | -40°C to +85°C | 8-Lead MSOP, standard grade, 13" Tape and Reel | RM-8 | Y49 |
| AD8421BRMZ | -40°C to +85°C | 8-Lead MSOP, high performance grade | RM-8 | Y4A |
| AD8421BRMZ-R7 | -40°C to +85°C | 8-Lead MSOP, high performance grade, 7" Tape and Reel | RM-8 | Y4A |
| AD8421BRMZ-RL | -40°C to +85°C | 8-Lead MSOP, high performance grade, 13" Tape and Reel | RM-8 | Y4A |

¹ Z = RoHS Compliant Part.

NOTES



Компания «ЭлектроПласт» предлагает заключение долгосрочных отношений при поставках импортных электронных компонентов на взаимовыгодных условиях!

Наши преимущества:

- Оперативные поставки широкого спектра электронных компонентов отечественного и импортного производства напрямую от производителей и с крупнейших мировых складов;
- Поставка более 17-ти миллионов наименований электронных компонентов;
- Поставка сложных, дефицитных, либо снятых с производства позиций;
- Оперативные сроки поставки под заказ (от 5 рабочих дней);
- Экспресс доставка в любую точку России;
- Техническая поддержка проекта, помощь в подборе аналогов, поставка прототипов;
- Система менеджмента качества сертифицирована по Международному стандарту ISO 9001;
- Лицензия ФСБ на осуществление работ с использованием сведений, составляющих государственную тайну;
- Поставка специализированных компонентов (Xilinx, Altera, Analog Devices, Intersil, Interpoint, Microsemi, Aeroflex, Peregrine, Syfer, Eurofarad, Texas Instrument, Miteq, Cobham, E2V, MA-COM, Hittite, Mini-Circuits, General Dynamics и др.);

Помимо этого, одним из направлений компании «ЭлектроПласт» является направление «Источники питания». Мы предлагаем Вам помощь Конструкторского отдела:

- Подбор оптимального решения, техническое обоснование при выборе компонента;
- Подбор аналогов;
- Консультации по применению компонента;
- Поставка образцов и прототипов;
- Техническая поддержка проекта;
- Защита от снятия компонента с производства.



Как с нами связаться

Телефон: 8 (812) 309 58 32 (многоканальный)

Факс: 8 (812) 320-02-42

Электронная почта: org@eplast1.ru

Адрес: 198099, г. Санкт-Петербург, ул. Калинина, дом 2, корпус 4, литера А.