

N-Channel Power MOSFET

600V, 38A, 99mΩ

FEATURES

- Super-Junction technology
- High performance, small $R_{DS(on)} * Q_g$ figure of merit (FOM)
- High ruggedness performance
- 100% UIS and R_g tested
- Compliant to RoHS Directive 2011/65/EU and in accordance to WEEE 2002/96/EC
- Halogen-free according to IEC 61249-2-21

KEY PERFORMANCE PARAMETERS		
PARAMETER	VALUE	UNIT
V_{DS}	600	V
$R_{DS(on)}$ (max)	99	mΩ
Q_g	62	nC

APPLICATIONS

- PFC stage
- Server/Telecom Power
- Charging Station
- Inverter
- Power Supply

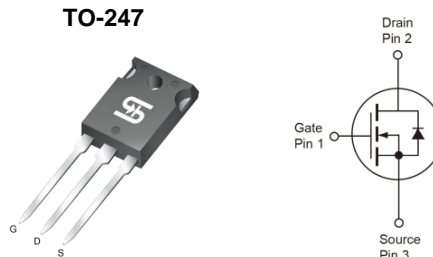

ABSOLUTE MAXIMUM RATINGS ($T_A = 25^\circ\text{C}$ unless otherwise noted)			
PARAMETER	SYMBOL	LIMIT	UNIT
Drain-Source Voltage	V_{DS}	600	V
Gate-Source Voltage	V_{GS}	± 30	V
Continuous Drain Current (Note 1)	I_D	$T_C = 25^\circ\text{C}$	38
		$T_C = 100^\circ\text{C}$	24
Pulsed Drain Current (Note 2)	I_{DM}	114	A
Total Power Dissipation @ $T_C = 25^\circ\text{C}$	P_D	329	W
Single Pulse Avalanche Energy (Note 3)	E_{AS}	784	mJ
Single Pulse Avalanche Current (Note 3)	I_{AS}	5.6	A
Operating Junction and Storage Temperature Range	T_J, T_{STG}	- 55 to +150	$^\circ\text{C}$

THERMAL PERFORMANCE			
PARAMETER	SYMBOL	LIMIT	UNIT
Junction to Case Thermal Resistance	$R_{\theta JC}$	0.38	$^\circ\text{C/W}$
Junction to Ambient Thermal Resistance	$R_{\theta JA}$	42	$^\circ\text{C/W}$

Thermal Performance Note: $R_{\theta JA}$ is the sum of the junction-to-case and case-to-ambient thermal resistances. The case-thermal reference is defined at the solder mounting surface of the drain pins. $R_{\theta JA}$ is guaranteed by design while $R_{\theta CA}$ is determined by the user's board design.

ELECTRICAL SPECIFICATIONS ($T_A = 25^\circ\text{C}$ unless otherwise noted)						
PARAMETER	CONDITIONS	SYMBOL	MIN	TYP	MAX	UNIT
Static						
Drain-Source Breakdown Voltage	$V_{GS} = 0\text{V}, I_D = 250\mu\text{A}$	BV_{DSS}	600	--	--	V
Gate Threshold Voltage	$V_{DS} = V_{GS}, I_D = 250\mu\text{A}$	$V_{GS(TH)}$	2	3	4	V
Gate Body Leakage	$V_{GS} = \pm 30\text{V}, V_{DS} = 0\text{V}$	I_{GSS}	--	--	± 100	nA
Zero Gate Voltage Drain Current	$V_{DS} = 600\text{V}, V_{GS} = 0\text{V}$	I_{DSS}	--	--	1	μA
Drain-Source On-State Resistance (Note 4)	$V_{GS} = 10\text{V}, I_D = 11.7\text{A}$	$R_{DS(on)}$	--	86	99	m Ω
Dynamic (Note 5)						
Total Gate Charge	$V_{DS} = 480\text{V}, I_D = 35\text{A},$ $V_{GS} = 10\text{V}$	Q_g	--	62	--	nC
Gate-Source Charge		Q_{gs}	--	17	--	
Gate-Drain Charge		Q_{gd}	--	25	--	
Input Capacitance	$V_{DS} = 100\text{V}, V_{GS} = 0\text{V},$ $f = 1.0\text{MHz}$	C_{iss}	--	2587	--	pF
Output Capacitance		C_{oss}	--	123	--	
Reverse Transfer Capacitance		C_{rss}	--	20	--	
Gate Resistance	$f = 1.0\text{MHz}$	R_g	--	3.3	6.6	Ω
Switching (Note 6)						
Turn-On Delay Time	$V_{DD} = 300\text{V},$ $R_{GEN} = 5\Omega,$ $I_D = 17.5\text{A}, V_{GS} = 10\text{V},$	$t_{d(on)}$	--	18	--	ns
Turn-On Rise Time		t_r	--	24	--	
Turn-Off Delay Time		$t_{d(off)}$	--	87	--	
Turn-Off Fall Time		t_f	--	25	--	
Source-Drain Diode						
Body-Diode Continuous Forward Current		I_S	--	--	38	A
Body-Diode Pulsed Current		I_{SM}	--	--	114	A
Forward Voltage (Note 4)	$I_S = 35\text{A}, V_{GS} = 0\text{V}$	V_{SD}	--	--	1.4	V
Reverse Recovery Time	$I_S = 17.5\text{A}$	t_{rr}	--	342	--	ns
Reverse Recovery Charge		$di_f/dt = 100\text{A}/\mu\text{s}$	Q_{rr}	--	5.3	--

Notes:

- Current limited by package.
- Pulse width limited by the maximum junction temperature.
- $L = 50\text{mH}, I_{AS} = 5.6\text{A}, V_{DD} = 50\text{V}, R_G = 25\Omega$, Starting $T_J = 25^\circ\text{C}$
- Pulse test: $PW \leq 300\mu\text{s}$, duty cycle $\leq 2\%$.
- For DESIGN AID ONLY, not subject to production testing.
- Switching time is essentially independent of operating temperature.

ORDERING INFORMATION

PART NO.	PACKAGE	PACKING
TSM60NB099PW C1G	TO-247	25pcs / Tube

CHARACTERISTICS CURVES

($T_c = 25^\circ\text{C}$ unless otherwise noted)

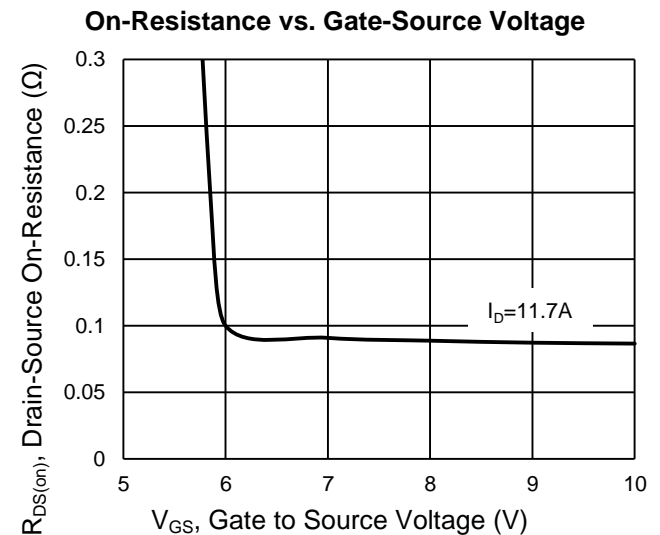
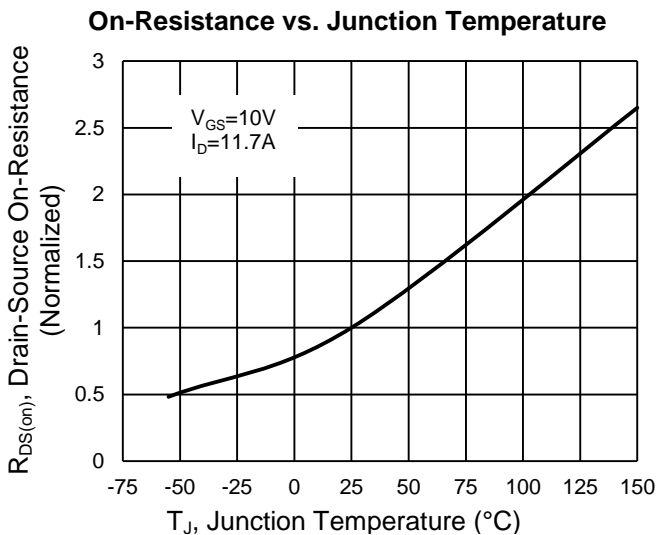
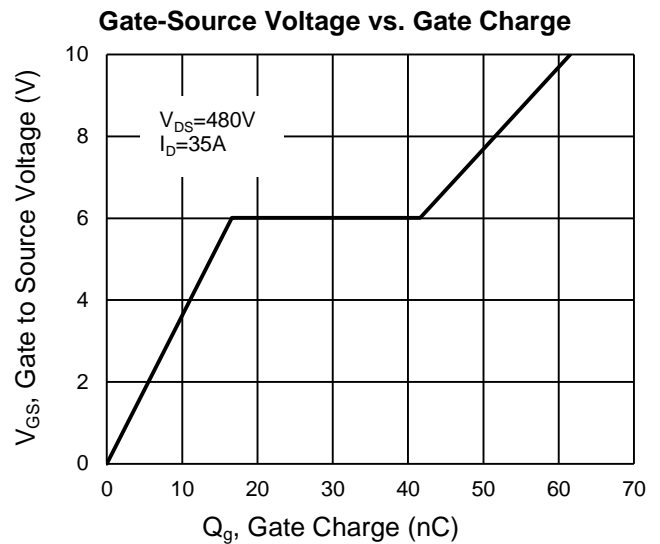
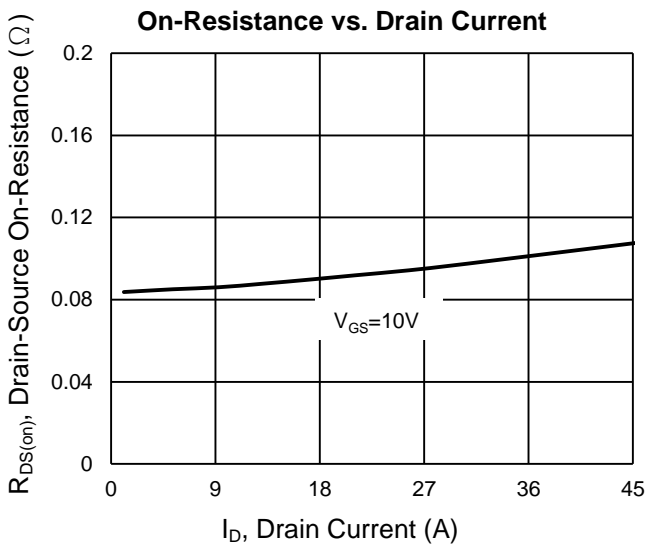
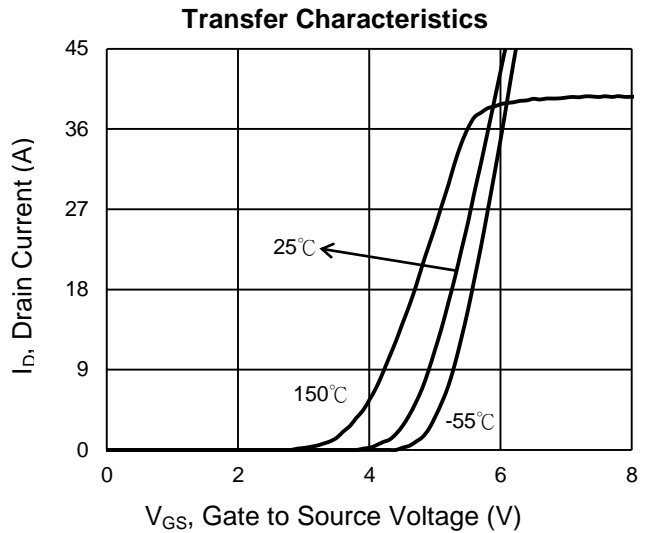
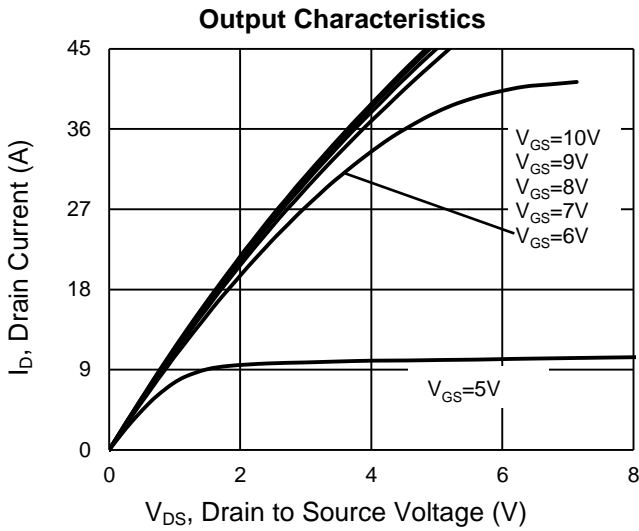

CHARACTERISTICS CURVES

($T_C = 25^\circ\text{C}$ unless otherwise noted)

Capacitance vs. Drain-Source Voltage

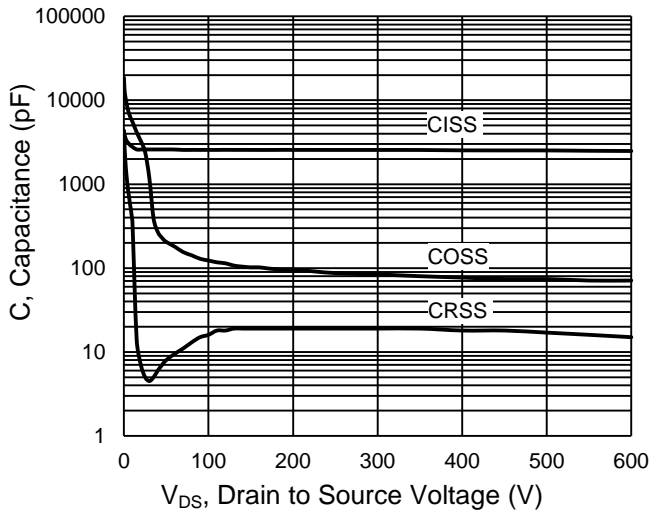

BV_{DSS} vs. Junction Temperature

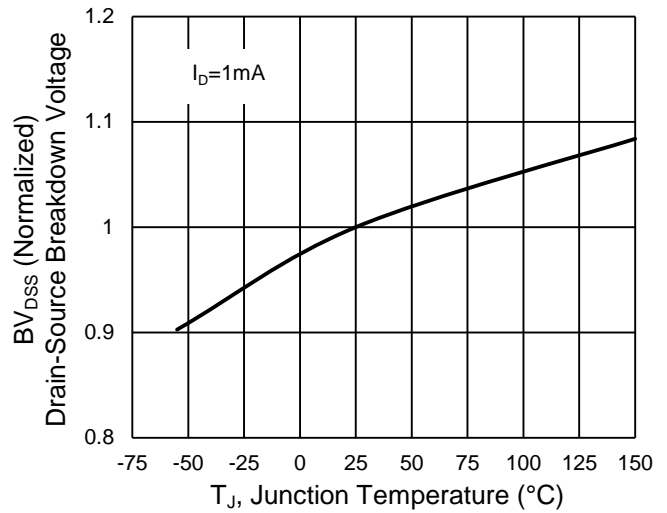

Maximum Safe Operating Area, Junction-to-Case

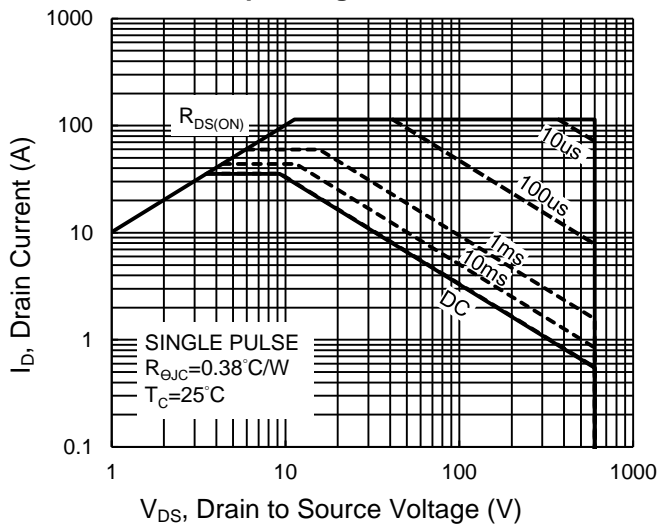

Source-Drain Diode Forward Current vs. Voltage

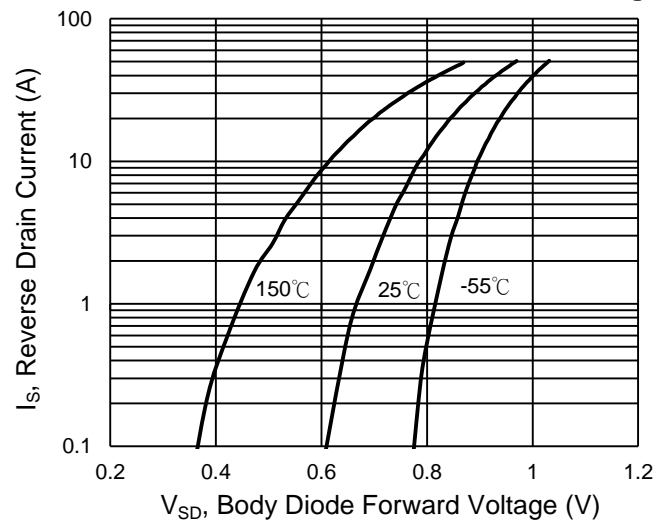

Normalized Thermal Transient Impedance, Junction-to-Case

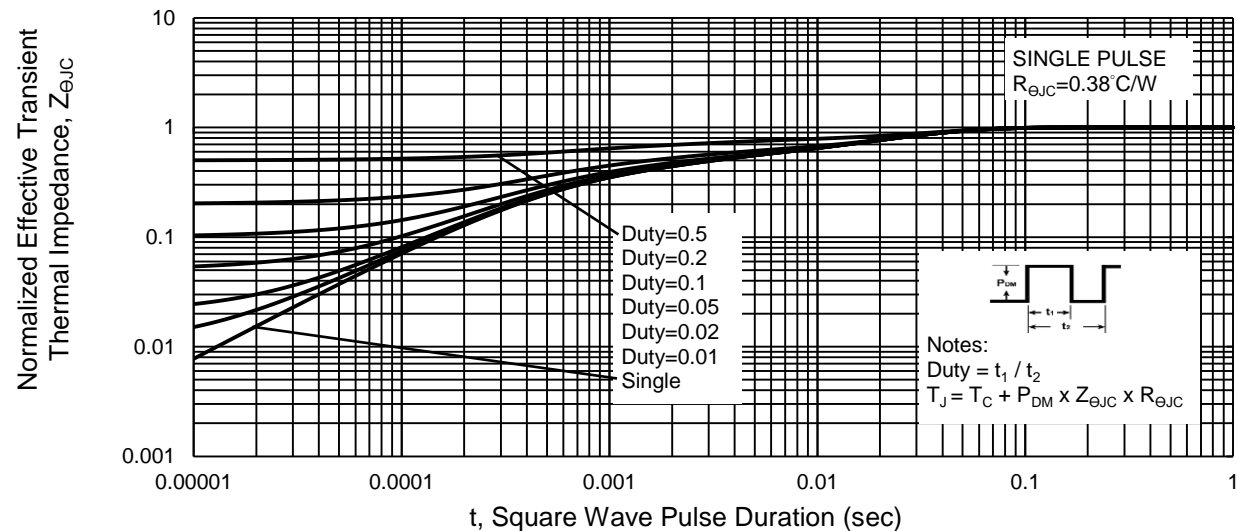

PACKAGE OUTLINE DIMENSIONS (Unit: Millimeters)

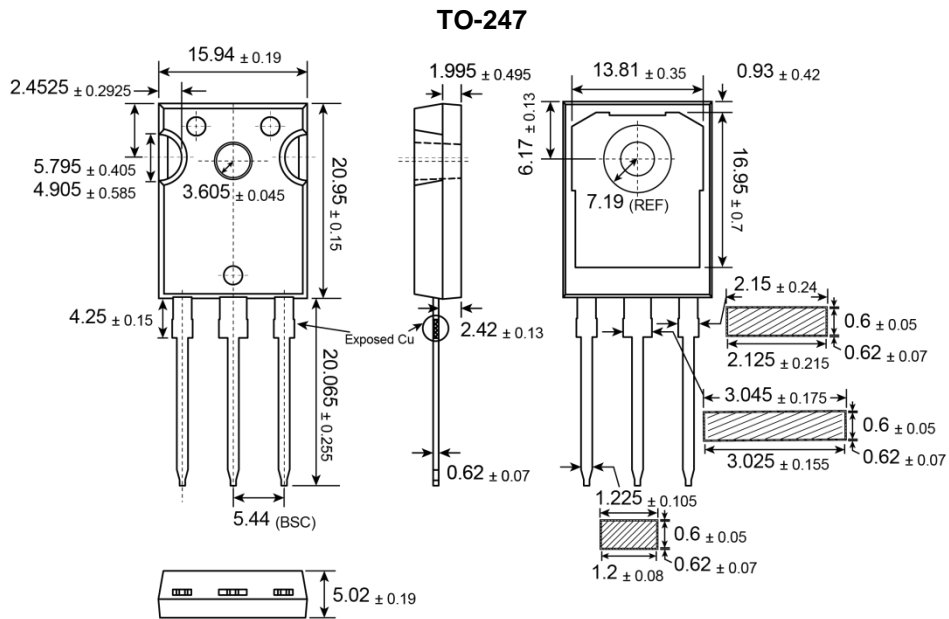

MARKING DIAGRAM



- G** = Halogen Free
- Y** = Year Code
- WW** = Week Code (01~52)
- F** = Factory Code

Notice

Specifications of the products displayed herein are subject to change without notice. TSC or anyone on its behalf, assumes no responsibility or liability for any errors or inaccuracies.

Information contained herein is intended to provide a product description only. No license, express or implied, to any intellectual property rights is granted by this document. Except as provided in TSC's terms and conditions of sale for such products, TSC assumes no liability whatsoever, and disclaims any express or implied warranty, relating to sale and/or use of TSC products including liability or warranties relating to fitness for a particular purpose, merchantability, or infringement of any patent, copyright, or other intellectual property right.

The products shown herein are not designed for use in medical, life-saving, or life-sustaining applications. Customers using or selling these products for use in such applications do so at their own risk and agree to fully indemnify TSC for any damages resulting from such improper use or sale.



Компания «ЭлектроПласт» предлагает заключение долгосрочных отношений при поставках импортных электронных компонентов на взаимовыгодных условиях!

Наши преимущества:

- Оперативные поставки широкого спектра электронных компонентов отечественного и импортного производства напрямую от производителей и с крупнейших мировых складов;
- Поставка более 17-ти миллионов наименований электронных компонентов;
- Поставка сложных, дефицитных, либо снятых с производства позиций;
- Оперативные сроки поставки под заказ (от 5 рабочих дней);
- Экспресс доставка в любую точку России;
- Техническая поддержка проекта, помощь в подборе аналогов, поставка прототипов;
- Система менеджмента качества сертифицирована по Международному стандарту ISO 9001;
- Лицензия ФСБ на осуществление работ с использованием сведений, составляющих государственную тайну;
- Поставка специализированных компонентов (Xilinx, Altera, Analog Devices, Intersil, Interpoint, Microsemi, Aeroflex, Peregrine, Syfer, Eurofarad, Texas Instrument, Miteq, Cobham, E2V, MA-COM, Hittite, Mini-Circuits, General Dynamics и др.);

Помимо этого, одним из направлений компании «ЭлектроПласт» является направление «Источники питания». Мы предлагаем Вам помощь Конструкторского отдела:

- Подбор оптимального решения, техническое обоснование при выборе компонента;
- Подбор аналогов;
- Консультации по применению компонента;
- Поставка образцов и прототипов;
- Техническая поддержка проекта;
- Защита от снятия компонента с производства.



Как с нами связаться

Телефон: 8 (812) 309 58 32 (многоканальный)

Факс: 8 (812) 320-02-42

Электронная почта: org@eplast1.ru

Адрес: 198099, г. Санкт-Петербург, ул. Калинина, дом 2, корпус 4, литера А.