



# RAYCHEM AS85049 ADAPTERS AND BAND STRAPS

THE INDUSTRY STANDARD FOR RUGGED, RELIABLE SHIELD  
TERMINATIONS . . . NOW WITH BLACK ZINC NICKEL PLATING

# AS85049 ADAPTERS AND BAND STRAPS

The Industry Standard for Rugged Reliable Shield Termination



## INDUSTRY STANDARD

- Meets AS85049 NAVAIR standards

## RELIABLE

- Self-coupling locking nut provides an improved mechanical protection against loosening under vibration
- Corrosion resistant

## EASY TO USE

- Band straps available flat for side entry or precoiled for end entry
- Side-entry band straps allow easier installation and repair

## VERSATILE

- Three band strap widths
- Cadmium, electroless nickel, or black zinc nickel plating

The AS85049 industry standard is used on most military circular connectors, including M38999. TE Connectivity (TE) offers a wide selection of sizes, materials and platings to meet your application needs.

The band strap termination system provides ease of installation and repair. TE offers the corrosion-resisting steel bands in three styles to help meet our customer's shield termination needs and termination tool of their choice.

## Product Performance

### APPLICATIONS

- Aerospace
- Marine
- Military Ground Vehicles
- Space-Based Systems

### MECHANICAL AND ELECTRIC PERFORMANCE

- **Qualification:** Meets AS85049 performance requirements

### MATERIALS

- **Bands Straps:** Stainless steel
- **Adapters:** Aluminum
- **Plating:** Cadmium, electroless nickel, or black zinc nickel

### STANDARDS AND SPECIFICATIONS

- **Application Specification:** MIP 102
- **Product Specification:** R85049
- **Military Specification:** AS85049/82 through /90 and /128

### APPLICATION TOOLING

- M85049/128-7 & 8      AS81306/1-02
- M85049/128-3 & 4      AS81306/1-01
- M85049/128-1 & 2      AS81306/2-01

## TE Components ... TE Technology ... TE Know-how ...

AMP | Agastat | CII | Hartman | Kilovac | Microdot | Nanonics | Raychem | Rochester | DEUTSCH

Get your product to market faster with a smarter, better solution.

# AS85049 Adapters And Band Straps

## BAND STRAP PART NUMBERING

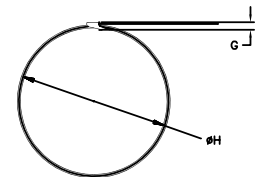
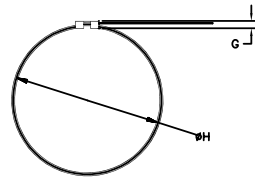
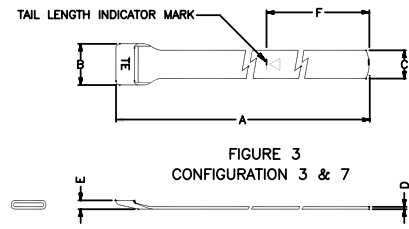
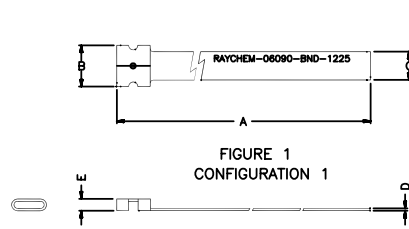
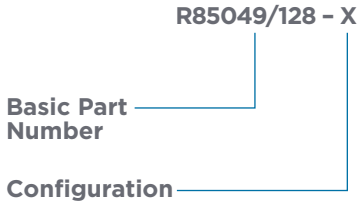
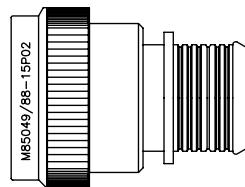
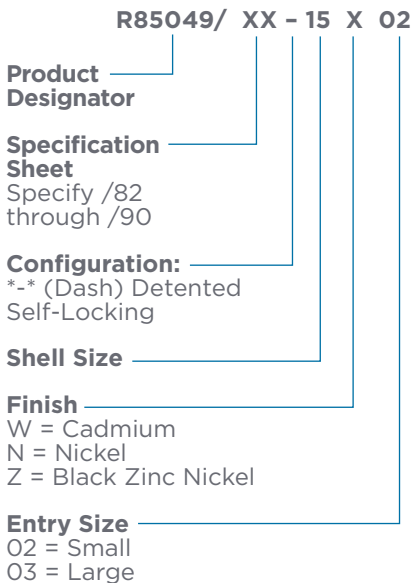

TABLE 1 — FIGURES 1, 2, 3, AND 4 CONFIGURATIONS AND DIMENSIONS

Config	Figure	A ± .060	B ± .031	C ± .010	D Ref	E Ref	F Ref	G Max	H Ref
1	1	14.00 (355.60)	.328 (8.33)	.245 (6.22)	.019 (0.48)	.100 (2.54)	—	—	—
2	2	—	—	—	—	—	—	.140 (3.56)	1.750 (44.46)
3	3	14.256 (362.10)	.350 (8.89)	.250 (6.35)	.020 (0.51)	.130 (3.30)	2.031 (51.59)	—	—
4	4	—	—	—	—	—	—	.150 (3.81)	1.750 (44.45)
7	3	8.125 (206.38)	.195 (4.95)	.120 (3.05)	.015 (0.38)	.053 (1.35)	2.031 (51.59)	—	—
8	4	—	—	—	—	—	—	.073 (1.85)	.860 (21.8)

## ADAPTER PART NUMBERING



SELF-LOCKING SHIELD BAND TERMINATION SHRINK BOOT ACCOMMODATION ADAPTER

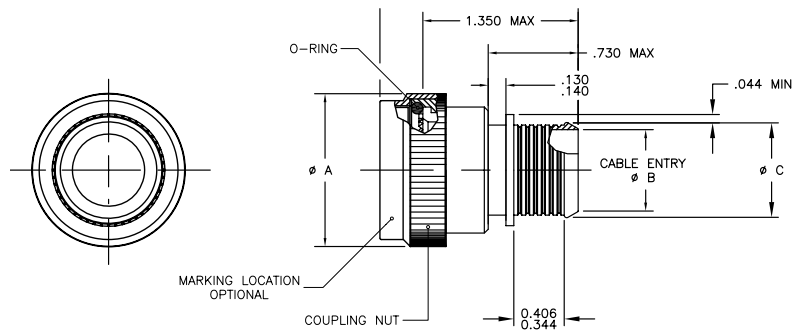

## For More Information

### TE Technical Support Center

North America	+1 800 522 6752
Asia Pacific	+86 0 400 820 6015
Austria	+43 1 905 601 228
Baltic Regions	+46 8 5072 5000
Benelux	+31 73 6246 999
Czech Republic	+420 800 701 462
France	+33 1 34 20 86 86
Germany	+49 6251 133 1999
Hungary	+36 809 874 04
Italy	+39 011 401 2632
Nordic	+46 8 5072 5000
Poland	+48 800 702 309
Russia	+7495 790 790 2
Spain/Portugal	+34 93 2910366
Switzerland	+41 52 633 66 26
United Kingdom	+44 800 267 666

Follow us on Twitter for all the latest product news  
@TEConnectivity, and on Facebook, TEConnectivity.

#### te.com

© 2014 TE Connectivity Ltd. family of companies. All Rights Reserved.

1-1773720-2 ADM/RRD 2.5M 12/2014

TE Connectivity and the TE connectivity (logo) are trademarks of the TE Connectivity Ltd. family of companies.

Other product or company names mentioned herein may be trademarks of their respective owners.

While TE has made every reasonable effort to ensure the accuracy of the information herein, nothing herein constitutes any guarantee that such information is error-free, or any other representation, warranty or guarantee that the information is accurate, correct, reliable or current. The TE entity issuing this publication reserves the right to make any adjustments to the information contained herein at any time without notice. All implied warranties regarding the information contained herein, including, but not limited to, any implied warranties of merchantability or fitness for a particular purpose are expressly disclaimed. The dimensions herein are for reference purposes only and are subject to change without notice. Specifications are subject to change without notice.

Consult TE for the latest dimensions and design specifications.



Компания «ЭлектроПласт» предлагает заключение долгосрочных отношений при поставках импортных электронных компонентов на взаимовыгодных условиях!

Наши преимущества:

- Оперативные поставки широкого спектра электронных компонентов отечественного и импортного производства напрямую от производителей и с крупнейших мировых складов;
- Поставка более 17-ти миллионов наименований электронных компонентов;
- Поставка сложных, дефицитных, либо снятых с производства позиций;
- Оперативные сроки поставки под заказ (от 5 рабочих дней);
- Экспресс доставка в любую точку России;
- Техническая поддержка проекта, помощь в подборе аналогов, поставка прототипов;
- Система менеджмента качества сертифицирована по Международному стандарту ISO 9001;
- Лицензия ФСБ на осуществление работ с использованием сведений, составляющих государственную тайну;
- Поставка специализированных компонентов (Xilinx, Altera, Analog Devices, Intersil, Interpoint, Microsemi, Aeroflex, Peregrine, Syfer, Eurofarad, Texas Instrument, Miteq, Cobham, E2V, MA-COM, Hittite, Mini-Circuits, General Dynamics и др.);

Помимо этого, одним из направлений компании «ЭлектроПласт» является направление «Источники питания». Мы предлагаем Вам помощь Конструкторского отдела:

- Подбор оптимального решения, техническое обоснование при выборе компонента;
- Подбор аналогов;
- Консультации по применению компонента;
- Поставка образцов и прототипов;
- Техническая поддержка проекта;
- Защита от снятия компонента с производства.



#### Как с нами связаться

**Телефон:** 8 (812) 309 58 32 (многоканальный)

**Факс:** 8 (812) 320-02-42

**Электронная почта:** [org@eplast1.ru](mailto:org@eplast1.ru)

**Адрес:** 198099, г. Санкт-Петербург, ул. Калинина, дом 2, корпус 4, литера А.