

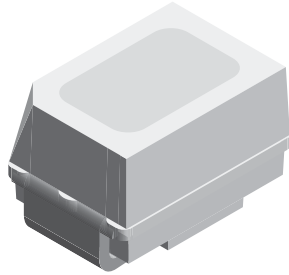

Power Mini SMD LED



19226

DESCRIPTION

The new MiniLED series has been designed in a small white SMT package. The feature of the device is the very small package 2.3 mm x 1.3 mm x 1.4 mm. The MiniLED is an obvious solution for small-scale, high-power products that are expected to work reliability in an arduous environment. This is often the case in automotive and industrial application.

PRODUCT GROUP AND PACKAGE DATA

- Product group: LED
- Product series: power
- Package: SMD MiniLED
- Angle of half intensity: ± 60°

FEATURES

- Utilizing latest advanced AllnGaP technology
- Available in 8 mm tape
- Luminous intensity and color categorized per packing unit
- Luminous intensity ratio per packing unit $I_{Vmax}/I_{Vmin} \leq 1.6$
- ESD-withstand voltage: up to 2 kV according to JESD22-A114-B
- Preconditioning: acc. to JEDEC level 2a
- IR reflow soldering
- Compliant to RoHS Directive 2002/95/EC and in accordance to WEEE 2002/96/EC
- AEC-Q101 qualified

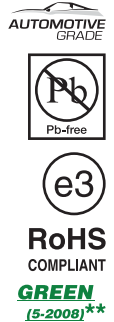

APPLICATIONS

- Traffic signals and signs
- Interior and exterior lighting
- Dashboard illumination
- Indicator and backlighting purposes for audio, video, LCDs switches, symbols, illuminated advertising etc

PARTS TABLE		
PART	COLOR, LUMINOUS INTENSITY	TECHNOLOGY
VLMS233T1V1-GS08	Super red, $I_V = (280 \text{ to } 900) \text{ mcd}$	AllnGaP on Si
VLMR233T2V2-GS08	Red, $I_V = (355 \text{ to } 1120) \text{ mcd}$	AllnGaP on Si
VLMK233U1AA-GS08	Amber, $I_V = (450 \text{ to } 1400) \text{ mcd}$	AllnGaP on Si
VLMO233U1AA-GS08	Soft orange, $I_V = (450 \text{ to } 1400) \text{ mcd}$	AllnGaP on Si
VLMO233U2V2-35-GS08	Soft orange, $I_V = (560 \text{ to } 1120) \text{ mcd}$	AllnGaP on Si
VLMY233T2V2-GS08	Yellow, $I_V = (355 \text{ to } 1120) \text{ mcd}$	AllnGaP on Si

** Please see document "Vishay Material Category Policy": www.vishay.com/doc?99902

ABSOLUTE MAXIMUM RATINGS ($T_{amb} = 25\text{ }^{\circ}\text{C}$, unless otherwise specified) VLM.233..				
PARAMETER	TEST CONDITION	SYMBOL	VALUE	UNIT
Reverse voltage ¹⁾	Short term application only	V_R	5	V
DC Forward current	$T_{amb} \leq 60\text{ }^{\circ}\text{C}$ (480 K/W)	I_F	50	mA
Power dissipation		P_V	130	mW
Junction temperature		T_j	125	$^{\circ}\text{C}$
Operating temperature range		T_{amb}	- 40 to + 100	$^{\circ}\text{C}$
Storage temperature range		T_{stg}	- 40 to + 100	$^{\circ}\text{C}$
Thermal resistance junction/ambient	Mounted on PC board (pad size > 16 mm ²)	R_{thJA}	480	K/W

Note:

¹⁾ Driving the LED in reverse direction is suitable for a short term application only

OPTICAL AND ELECTRICAL CHARACTERISTICS ($T_{amb} = 25\text{ }^{\circ}\text{C}$, unless otherwise specified) VLMS233.., SUPER RED							
PARAMETER	TEST CONDITION	PART	SYMBOL	MIN.	TYP.	MAX.	UNIT
Luminous intensity	$I_F = 20\text{ mA}$	VLMS233T1V1	I_V	280	450	900	mcd
Luminous flux/luminous intensity			ϕ_V/I_V		3		mlm/mcd
Dominant wavelength	$I_F = 20\text{ mA}$		λ_d	626	630	639	nm
Peak wavelength	$I_F = 20\text{ mA}$		λ_p		639		nm
Spectral bandwidth at 50 % $I_{rel\ max.}$	$I_F = 20\text{ mA}$		$\Delta\lambda$		18		nm
Angle of half intensity	$I_F = 20\text{ mA}$		φ		± 60		deg
Forward voltage	$I_F = 20\text{ mA}$		V_F	1.8	2	2.6	V
Reverse current	$V_R = 5\text{ V}$		I_R		0.01	10	μA

OPTICAL AND ELECTRICAL CHARACTERISTICS ($T_{amb} = 25\text{ }^{\circ}\text{C}$, unless otherwise specified) VLMR233.., RED							
PARAMETER	TEST CONDITION	PART	SYMBOL	MIN.	TYP.	MAX.	UNIT
Luminous intensity	$I_F = 20\text{ mA}$	VLMR233T2V2	I_V	355	650	1120	mcd
Luminous flux/luminous intensity			ϕ_V/I_V		3		mlm/mcd
Dominant wavelength	$I_F = 20\text{ mA}$		λ_d	619	625	631	nm
Peak wavelength	$I_F = 20\text{ mA}$		λ_p		632		nm
Spectral bandwidth at 50 % $I_{rel\ max.}$	$I_F = 20\text{ mA}$		$\Delta\lambda$		18		nm
Angle of half intensity	$I_F = 20\text{ mA}$		φ		± 60		deg
Forward voltage	$I_F = 20\text{ mA}$		V_F	1.8	2	2.6	V
Reverse current	$V_R = 5\text{ V}$		I_R		0.01	10	μA



OPTICAL AND ELECTRICAL CHARACTERISTICS ($T_{amb} = 25\text{ }^{\circ}\text{C}$, unless otherwise specified) VLMK233..., AMBER							
PARAMETER	TEST CONDITION	PART	SYMBOL	MIN.	TYP.	MAX.	UNIT
Luminous intensity	$I_F = 20\text{ mA}$	VLMK233U1AA	I_V	450	680	1400	mcd
Luminous flux/luminous intensity			ϕ_V/I_V		3		mlm/mcd
Dominant wavelength	$I_F = 20\text{ mA}$		λ_d	611	616	622	nm
Peak wavelength	$I_F = 20\text{ mA}$		λ_p		622		nm
Spectral bandwidth at 50 % $I_{rel\ max.}$	$I_F = 20\text{ mA}$		$\Delta\lambda$		18		nm
Angle of half intensity	$I_F = 20\text{ mA}$		φ		± 60		deg
Forward voltage	$I_F = 20\text{ mA}$		V_F	1.8	2.1	2.6	V
Reverse current	$V_R = 5\text{ V}$		I_R		0.01	10	μA

OPTICAL AND ELECTRICAL CHARACTERISTICS ($T_{amb} = 25\text{ }^{\circ}\text{C}$, unless otherwise specified) VLMO233..., SOFT ORANGE							
PARAMETER	TEST CONDITION	PART	SYMBOL	MIN.	TYP.	MAX.	UNIT
Luminous intensity	$I_F = 20\text{ mA}$	VLMO233U1AA	I_V	450	760	1400	mcd
		VLMO233U2V2-35		560	760	1120	
Luminous flux/luminous intensity			ϕ_V/I_V		3		mlm/mcd
Dominant wavelength	$I_F = 20\text{ mA}$	VLMO233U1AA	λ_d	600	605	611	nm
		VLMO233U2V2-35		602	605	609	nm
Peak wavelength	$I_F = 20\text{ mA}$		λ_p		611		nm
Spectral bandwidth at 50 % $I_{rel\ max.}$	$I_F = 20\text{ mA}$		$\Delta\lambda$		17		nm
Angle of half intensity	$I_F = 20\text{ mA}$		φ		± 60		deg
Forward voltage	$I_F = 20\text{ mA}$		V_F	1.8	2.1	2.6	V
Reverse current	$V_R = 5\text{ V}$		I_R		0.01	10	μA

OPTICAL AND ELECTRICAL CHARACTERISTICS ($T_{amb} = 25\text{ }^{\circ}\text{C}$, unless otherwise specified) VLMY233..., YELLOW							
PARAMETER	TEST CONDITION	PART	SYMBOL	MIN.	TYP.	MAX.	UNIT
Luminous intensity	$I_F = 20\text{ mA}$	VLMY233T2V2	I_V	355	650	1120	mcd
Luminous flux/luminous intensity			ϕ_V/I_V		3		mlm/mcd
Dominant wavelength	$I_F = 20\text{ mA}$		λ_d	583	589	594	nm
Peak wavelength	$I_F = 20\text{ mA}$		λ_p		591		nm
Spectral bandwidth at 50 % $I_{rel\ max.}$	$I_F = 20\text{ mA}$		$\Delta\lambda$		17		nm
Angle of half intensity	$I_F = 20\text{ mA}$		φ		± 60		deg
Forward voltage	$I_F = 20\text{ mA}$		V_F	1.8	2.15	2.6	V
Reverse current	$V_R = 5\text{ V}$		I_R		0.01	10	μA

COLOR CLASSIFICATION						
GROUP	DOMINANT WAVELENGTH (nm)					
	AMBER		SOFT ORANGE		YELLOW	
	MIN.	MAX.	MIN.	MAX.	MIN.	MAX.
1	611	618				
2	614	622	600	603	583	586
3			602	605	585	588
4			604	607	587	590
5			606	609	589	592
6			608	611	591	594

Note:
 Wavelengths are tested at a current pulse duration of 25 ms.

LUMINOUS INTENSITY CLASSIFICATION			
GROUP	LUMINOUS INTENSITY (mcd)		
STANDARD	OPTIONAL	MIN.	MAX.
T	1	280	355
	2	355	450
U	1	450	560
	2	560	710
V	1	710	900
	2	900	1120
A	A	1120	1400
	B	1400	1800

Note:
 Luminous intensity is tested at a current pulse duration of 25 ms and an accuracy of $\pm 11\%$.

The above type numbers represent the order groups which include only a few brightness groups. Only one group will be shipped on each reel (there will be no mixing of two groups on each reel).

In order to ensure availability, single brightness groups will not be orderable.

In a similar manner for colors where wavelength groups are measured and binned, single wavelength groups will be shipped on any one reel.

In order to ensure availability, single wavelength groups will not be orderable.

CROSSING TABLE	
VISHAY	OSRAM
VLMS233T1V1	LS M67F-S2U2-1
VLMO233U2V2-35	LO M67F-U2AB-24
VLMY233T2V2	LY M67F-T2V2-36



TYPICAL CHARACTERISTICS (T_{amb} = 25 °C, unless otherwise specified)

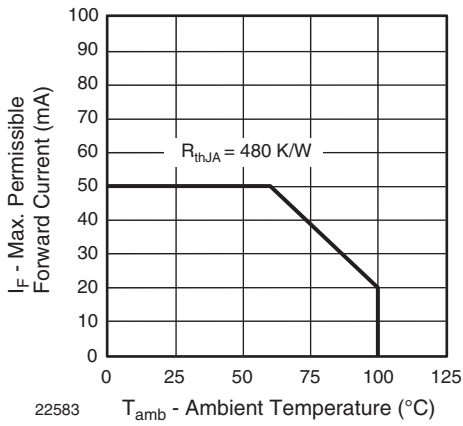

Figure 1. Max. Permissible Forward Current vs. Ambient Temperature

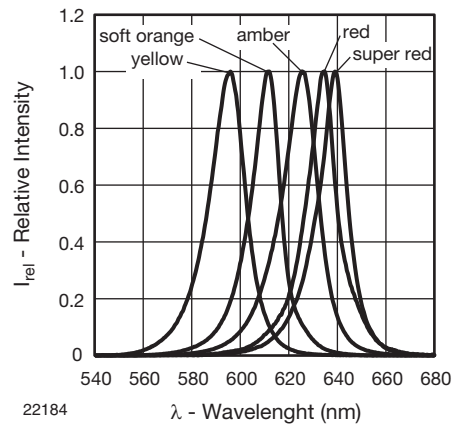

Figure 4. Relative Intensity vs. Wavelength

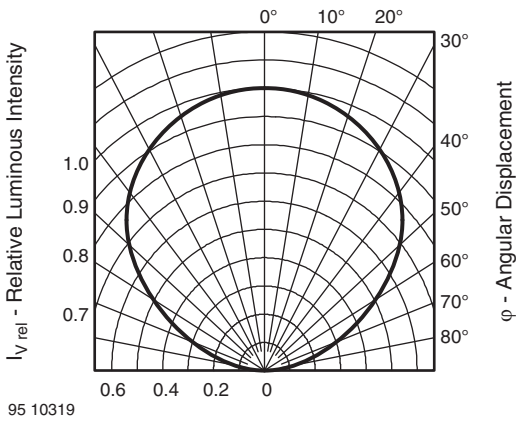

Figure 2. Rel. Luminous Intensity vs. Angular Displacement

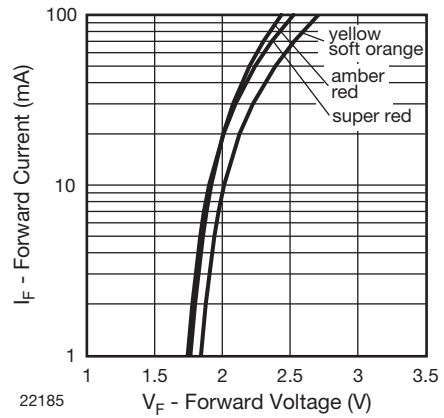

Figure 5. Forward Current vs. Forward Voltage

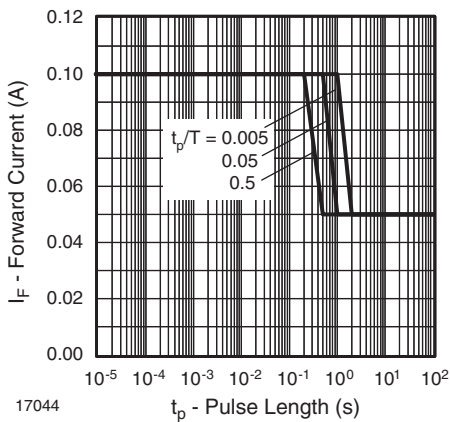

Figure 3. Forward Current vs. Pulse Length

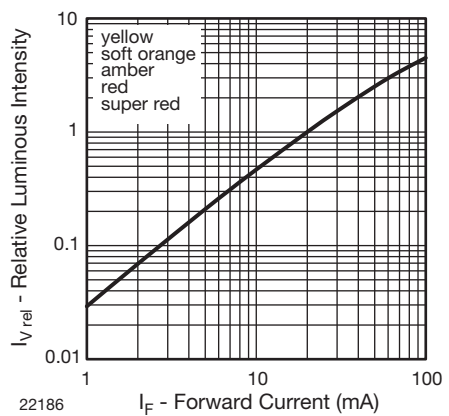

Figure 6. Relative Luminous Intensity vs. Forward Current

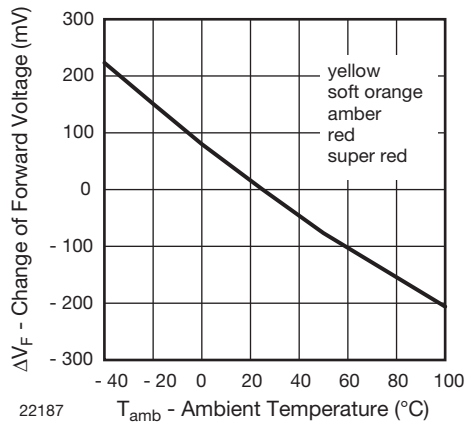

Figure 7. Change of Forward Voltage vs. Ambient Temperature

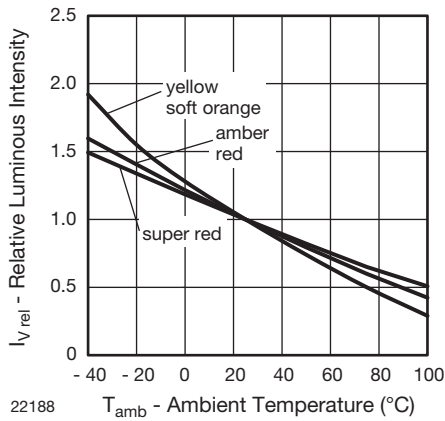

Figure 8. Relative Luminous Intensity vs. Amb. Temperature

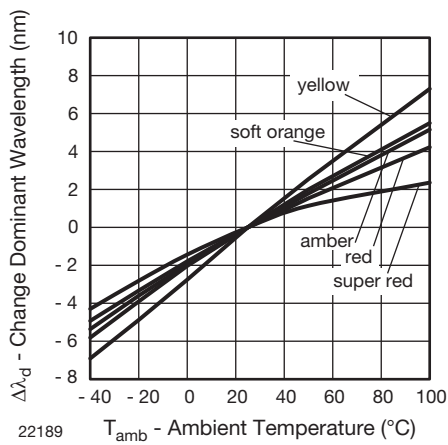
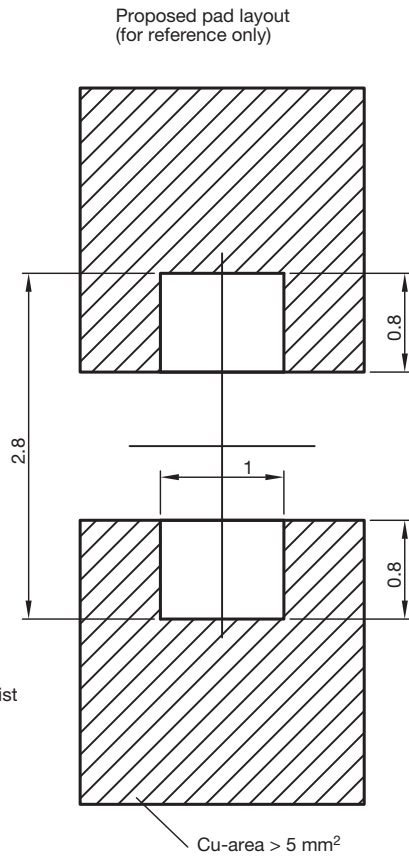
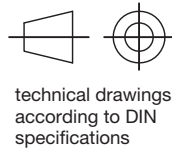
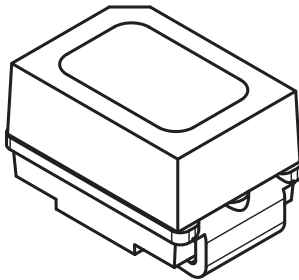
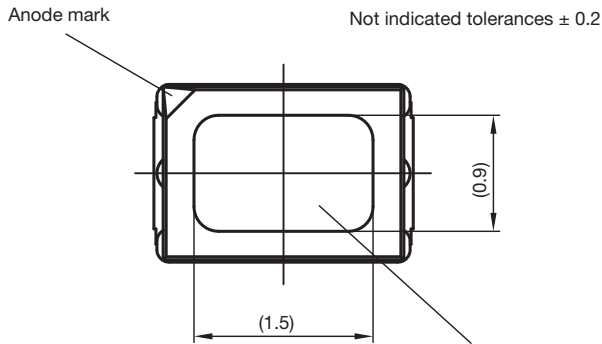
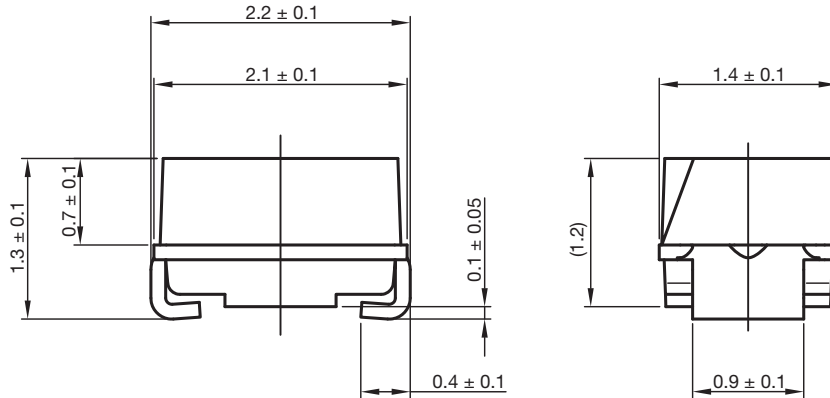

Figure 9. Change of Dominant Wavelength vs. Ambient Temperature



PACKAGE DIMENSIONS in millimeters



Drawing refers to following types: VLM. 233.
 Drawing-No.: 6.541-5090.01-4
 Issue: 1; 15.07.11
 22584

TAPE DIMENSIONS in millimeters

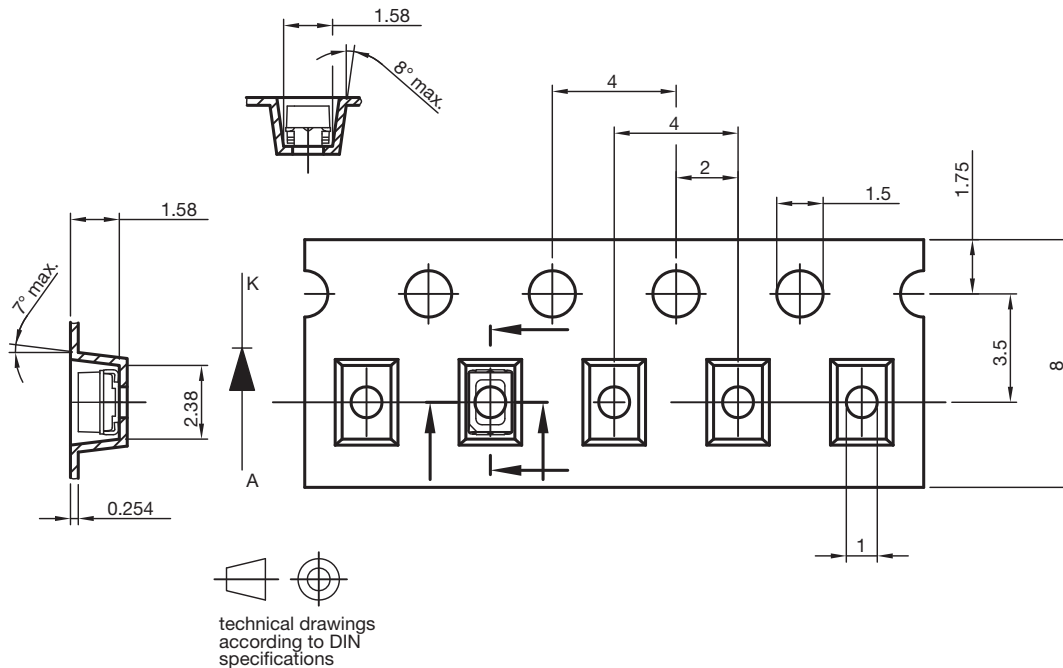

Drawing refers to following types: Mini SMD LED VLM. 233.

Drawing-No.: 9.700-5381.01-4

Issue: 1; 15.07.11

22585

LEADER AND TRAILER in millimeters

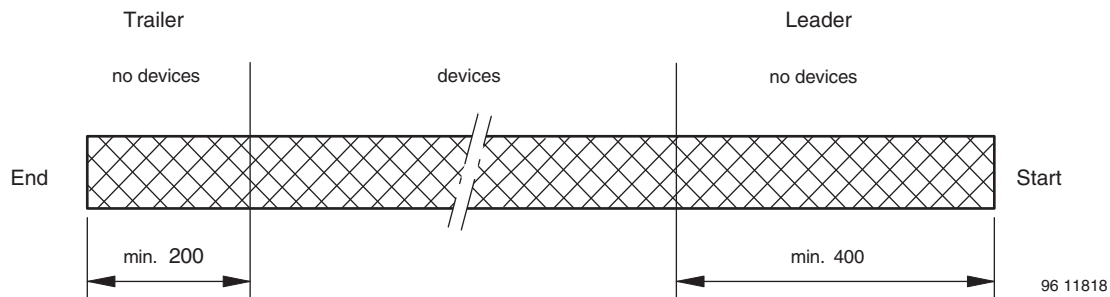

GS08 = 3000 pcs

COVER TAPE PEEL STRENGTH

According to DIN EN 60286-3

0.1 N to 1.3 N

300 ± 10 mm/min

165° to 180° peel angle

LABEL

Standard bar code labels for finished goods

The standard bar code labels are product labels and used for identification of goods. The finished goods are packed in final packing area. The standard packing units are labeled with standard bar code labels before transported as finished goods to warehouses. The labels are on each packing unit and contain Vishay Semiconductor GmbH specific data.



SOLDERING PROFILE

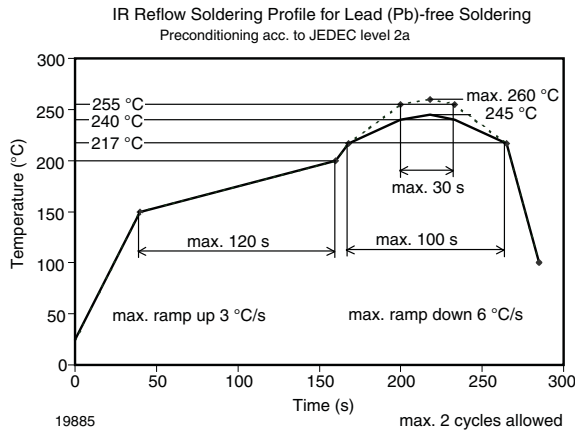
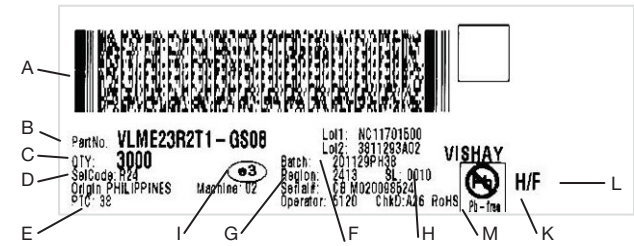

Figure 10. Vishay Lead (Pb)-free Reflow Soldering Profile (acc. to J-STD-020)

BAR CODE PRODUCT LABEL EXAMPLE:



- A) 2D barcode
- B) Vishay part number
- C) Quantity
- D) PTC = selection code (binning)
- E) Code of manufacturing plant
- F) Batch = date code: year/week/plant code
- G) Region code
- H) SL = sales location
- I) Terminations finishing
- K) Lead (Pb)-free symbol
- L) Halogen-free symbol
- M) RoHS symbol

DRY PACKING

The reel is packed in an anti-humidity bag to protect the devices from absorbing moisture during transportation and storage.

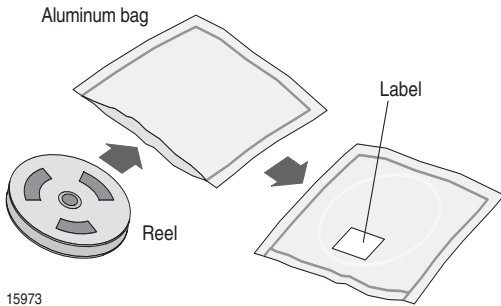

15973

FINAL PACKING

The sealed reel is packed into a cardboard box. A secondary cardboard box is used for shipping purposes.

RECOMMENDED METHOD OF STORAGE

Dry box storage is recommended as soon as the aluminum bag has been opened to prevent moisture absorption. The following conditions should be observed, if dry boxes are not available:

- Storage temperature 10 °C to 30 °C
- Storage humidity ≤ 60 % RH max.

After more than 672 h under these conditions moisture content will be too high for reflow soldering.

In case of moisture absorption, the devices will recover to the former condition by drying under the following condition:

192 h at 40 °C + 5 °C/- 0 °C and < 5 % RH (dry air/nitrogen) or

96 h at 60 °C + 5 °C and < 5 % RH for all device containers or

24 h at 100 °C + 5 °C not suitable for reel or tubes.

An EIA JEDEC Standard JESD22-A112 Level 2a label is included on all dry bags.

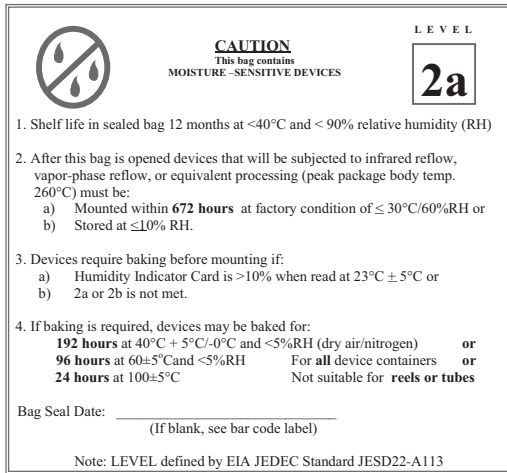

Example of JESD22-A112 Level 2a Label

ESD PRECAUTION

Proper storage and handling procedures should be followed to prevent ESD damage to the devices especially when they are removed from the antistatic shielding bag. Electro-static sensitive devices warning labels are on the packaging.

VISHAY SEMICONDUCTORS STANDARD BAR CODE LABELS

The Vishay Semiconductors standard bar-code labels are printed at final packing areas. The labels are on each packing unit and contain Vishay Semiconductors specific data.



Disclaimer

ALL PRODUCT, PRODUCT SPECIFICATIONS AND DATA ARE SUBJECT TO CHANGE WITHOUT NOTICE TO IMPROVE RELIABILITY, FUNCTION OR DESIGN OR OTHERWISE.

Vishay Intertechnology, Inc., its affiliates, agents, and employees, and all persons acting on its or their behalf (collectively, "Vishay"), disclaim any and all liability for any errors, inaccuracies or incompleteness contained in any datasheet or in any other disclosure relating to any product.

Vishay makes no warranty, representation or guarantee regarding the suitability of the products for any particular purpose or the continuing production of any product. To the maximum extent permitted by applicable law, Vishay disclaims (i) any and all liability arising out of the application or use of any product, (ii) any and all liability, including without limitation special, consequential or incidental damages, and (iii) any and all implied warranties, including warranties of fitness for particular purpose, non-infringement and merchantability.

Statements regarding the suitability of products for certain types of applications are based on Vishay's knowledge of typical requirements that are often placed on Vishay products in generic applications. Such statements are not binding statements about the suitability of products for a particular application. It is the customer's responsibility to validate that a particular product with the properties described in the product specification is suitable for use in a particular application. Parameters provided in datasheets and/or specifications may vary in different applications and performance may vary over time. All operating parameters, including typical parameters, must be validated for each customer application by the customer's technical experts. Product specifications do not expand or otherwise modify Vishay's terms and conditions of purchase, including but not limited to the warranty expressed therein.

Except as expressly indicated in writing, Vishay products are not designed for use in medical, life-saving, or life-sustaining applications or for any other application in which the failure of the Vishay product could result in personal injury or death. Customers using or selling Vishay products not expressly indicated for use in such applications do so at their own risk. Please contact authorized Vishay personnel to obtain written terms and conditions regarding products designed for such applications.

No license, express or implied, by estoppel or otherwise, to any intellectual property rights is granted by this document or by any conduct of Vishay. Product names and markings noted herein may be trademarks of their respective owners.

Material Category Policy

Vishay Intertechnology, Inc. hereby certifies that all its products that are identified as RoHS-Compliant fulfill the definitions and restrictions defined under Directive 2011/65/EU of The European Parliament and of the Council of June 8, 2011 on the restriction of the use of certain hazardous substances in electrical and electronic equipment (EEE) - recast, unless otherwise specified as non-compliant.

Please note that some Vishay documentation may still make reference to RoHS Directive 2002/95/EC. We confirm that all the products identified as being compliant to Directive 2002/95/EC conform to Directive 2011/65/EU.

Vishay Intertechnology, Inc. hereby certifies that all its products that are identified as Halogen-Free follow Halogen-Free requirements as per JEDEC JS709A standards. Please note that some Vishay documentation may still make reference to the IEC 61249-2-21 definition. We confirm that all the products identified as being compliant to IEC 61249-2-21 conform to JEDEC JS709A standards.



Компания «ЭлектроПласт» предлагает заключение долгосрочных отношений при поставках импортных электронных компонентов на взаимовыгодных условиях!

Наши преимущества:

- Оперативные поставки широкого спектра электронных компонентов отечественного и импортного производства напрямую от производителей и с крупнейших мировых складов;
- Поставка более 17-ти миллионов наименований электронных компонентов;
- Поставка сложных, дефицитных, либо снятых с производства позиций;
- Оперативные сроки поставки под заказ (от 5 рабочих дней);
- Экспресс доставка в любую точку России;
- Техническая поддержка проекта, помощь в подборе аналогов, поставка прототипов;
- Система менеджмента качества сертифицирована по Международному стандарту ISO 9001;
- Лицензия ФСБ на осуществление работ с использованием сведений, составляющих государственную тайну;
- Поставка специализированных компонентов (Xilinx, Altera, Analog Devices, Intersil, Interpoint, Microsemi, Aeroflex, Peregrine, Syfer, Eurofarad, Texas Instrument, Miteq, Cobham, E2V, MA-COM, Hittite, Mini-Circuits, General Dynamics и др.);

Помимо этого, одним из направлений компании «ЭлектроПласт» является направление «Источники питания». Мы предлагаем Вам помощь Конструкторского отдела:

- Подбор оптимального решения, техническое обоснование при выборе компонента;
- Подбор аналогов;
- Консультации по применению компонента;
- Поставка образцов и прототипов;
- Техническая поддержка проекта;
- Защита от снятия компонента с производства.



Как с нами связаться

Телефон: 8 (812) 309 58 32 (многоканальный)

Факс: 8 (812) 320-02-42

Электронная почта: org@eplast1.ru

Адрес: 198099, г. Санкт-Петербург, ул. Калинина, дом 2, корпус 4, литера А.