

# JSM Series Sub-Miniature Slide Switches

## Features/Benefits

- RoHS compliant and meets all requirements of RoHS directive 2002/95EC, Halogen Free
- Positive detent
- Low profile
- IR reflow to 260° solder profile
- Surface and thru hole mounting
- Maintained and momentary functions
- SPDT, SP3T models

## Typical Applications

- Telecommunication products
- Computer peripherals
- Thermostat select switch
- Instrumentations

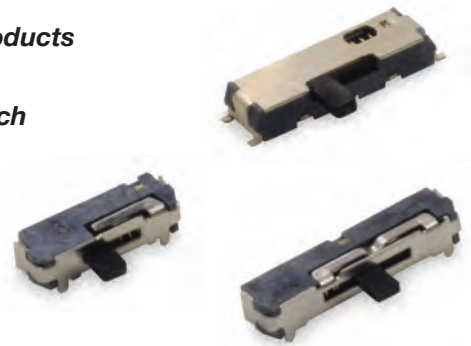

## Specifications

CONTACT RATING: 4 VDC @ 0.3A  
 ELECTRICAL LIFE: 10,000 make-and-break cycles at full load.  
 CONTACT RESISTANCE: 70 m Ω max.  
 INSULATION RESISTANCE: 100 M Ω min. @ 500V.  
 DIELECTRIC STRENGTH: 100 VAC min. @ sea level.  
 OPERATING TEMPERATURE: -10°C to +60°C  
 STORAGE TEMPERATURE: -30°C to +85°C

**NOTE:** Specifications and materials listed above are for switches with standard options.  
 For information on specific and custom switches, consult Customer Service Center.

## Materials

HOUSING: LCP, Glass filled (Halogen free)  
 ACTUATOR: 4/6 nylon (UL94V-2), black.  
 CONTACTS: Beryllium copper, silver plated.  
 TERMINALS: Brass, silver plated.  
 COVER: Stainless steel  
 RETURN SPRING: Stainless steel

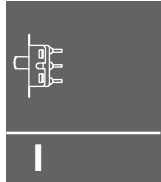

Slide

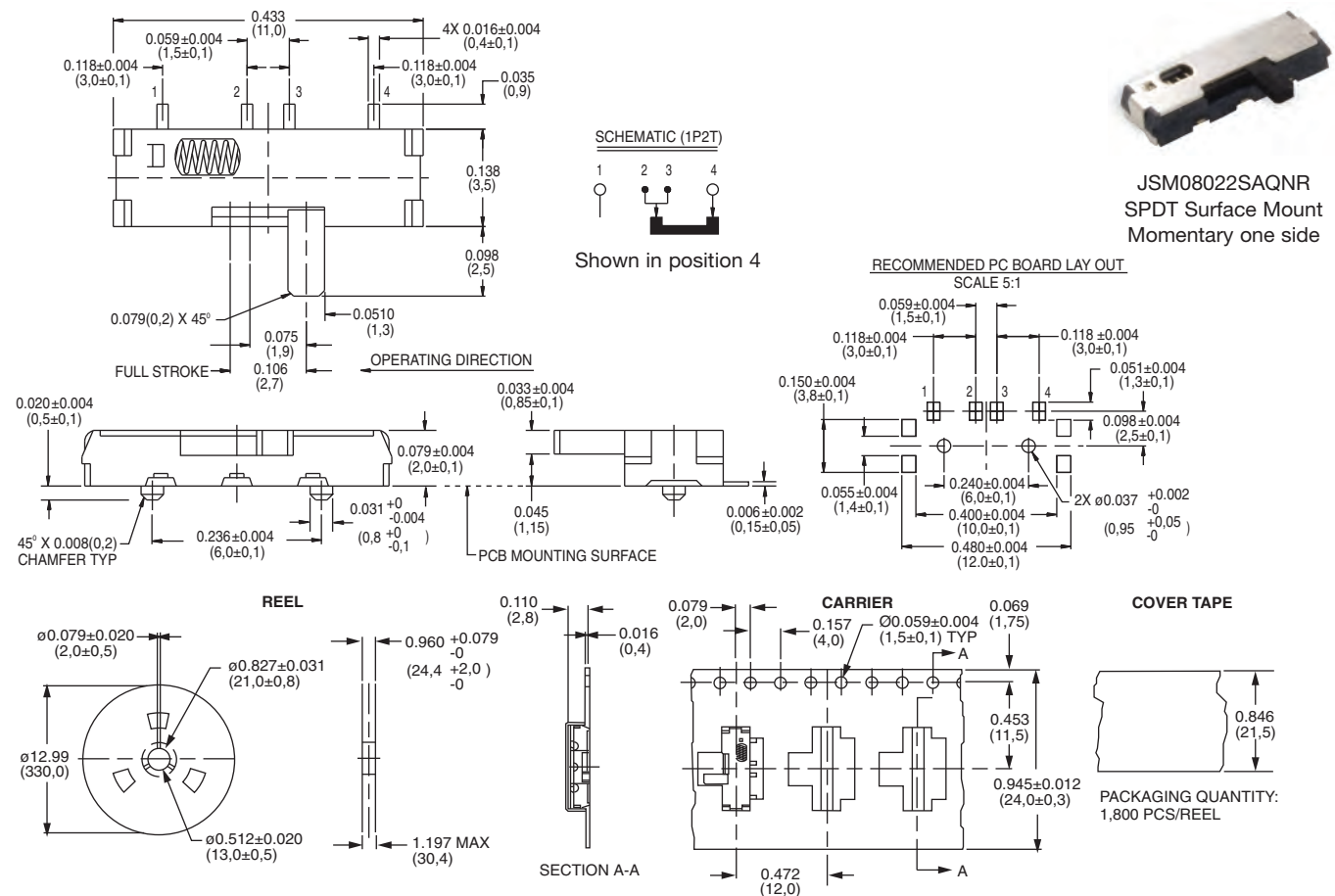

Third Angle  
Projection  
Dimensions are shown: Inches (mm)  
Specifications and dimensions subject to change

# JSM Series Sub-Miniature Slide Switches

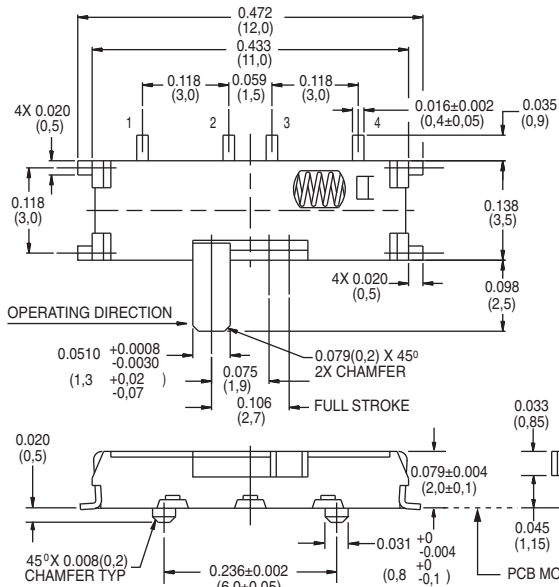

**SCHEMATIC (1P2T)**



Shown in position 1



**JSM08022SAQNL**  
SPDT Surface Mount  
Momentary only

**RECOMMENDED PC BOARD LAY OUT**

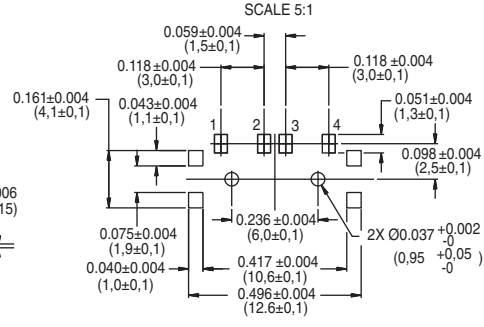

Slide

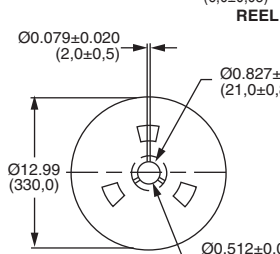

**REEL**

**CARRIER TAPE**

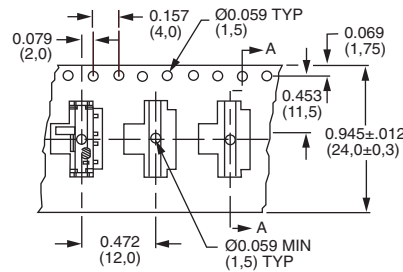

**COVER TAPE**

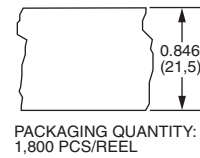

PACKAGING QUANTITY:  
1,800 PCS/REEL

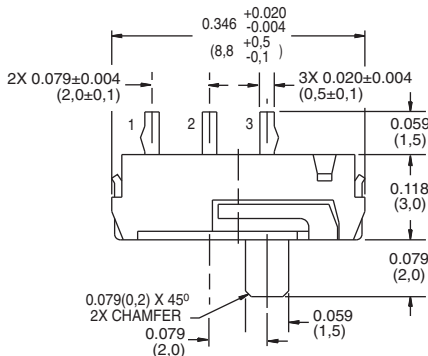

**SCHEMATIC (1P2T)**



Shown in position 2



**JSM08011SAQNR**  
SPDT Surface Mount  
Momentary only

**RECOMMENDED PC BOARD LAY OUT**

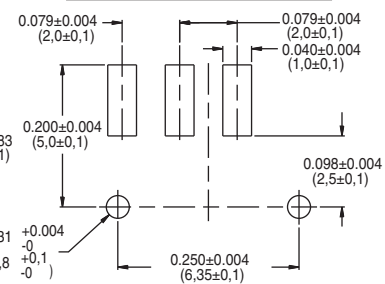

**PC BOARD MOUNTING SURFACE**

**REEL**

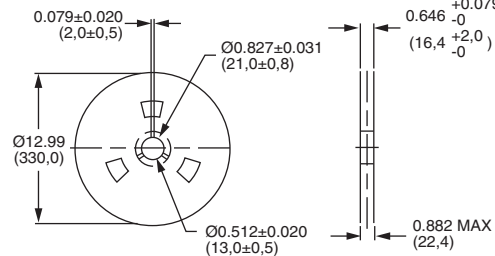

**CARRIER TAPE**

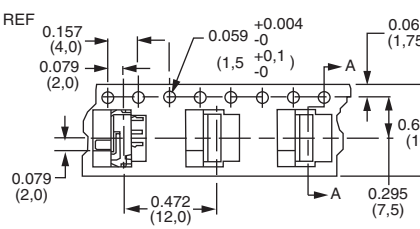

**COVER TAPE**



PACKAGING QUANTITY:  
1,800 PCS/REEL



Third Angle  
Projection

Dimensions are shown: Inch (mm)  
Specifications and dimensions subject to change



# JSM Series Sub-Miniature Slide Switches

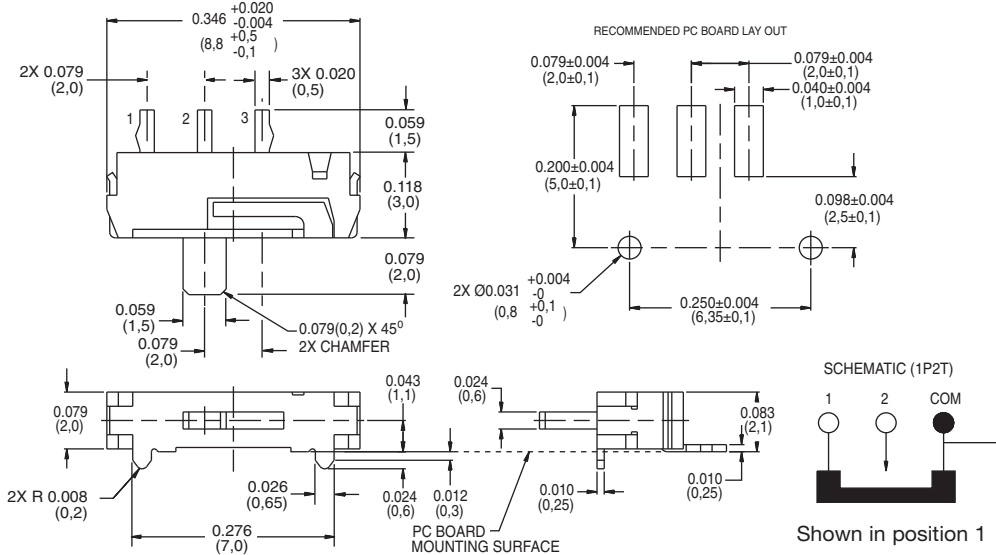

JSM08011SAQNL  
SPDT Surface Mount  
Momentary only

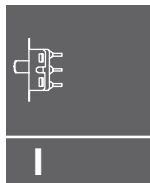

Slide

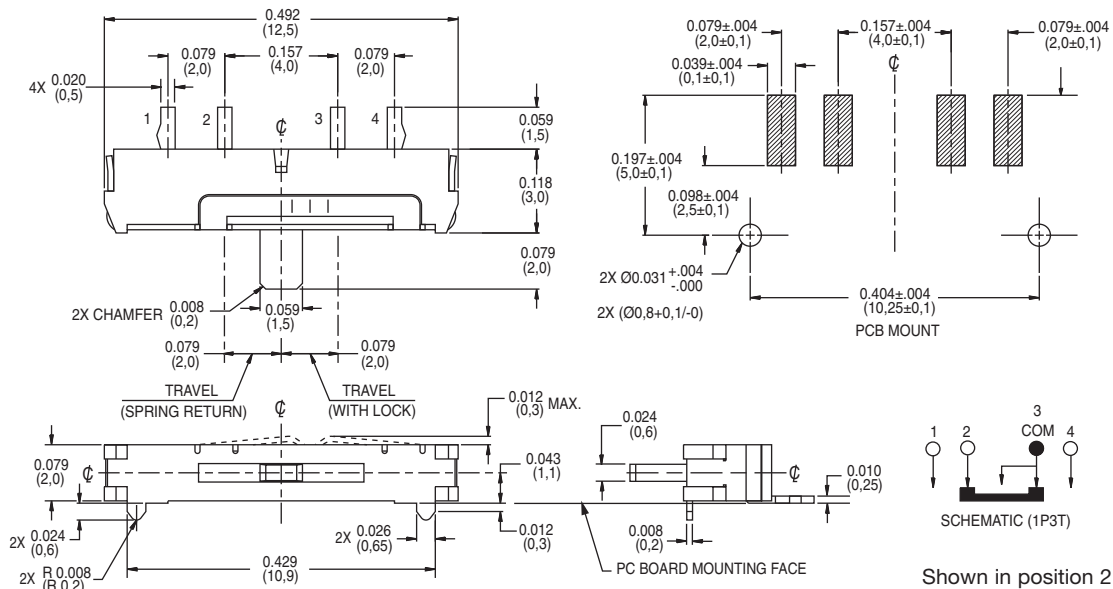
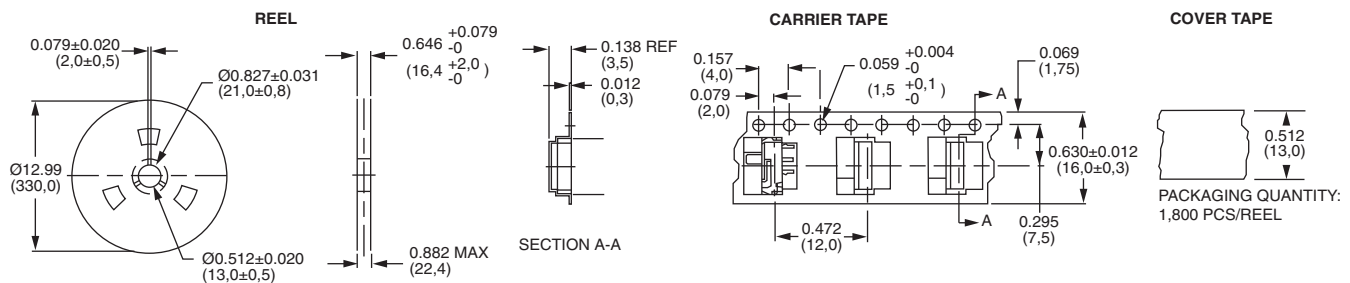

JSM07011SAQNR  
SP3T Surface Mount  
Momentary one side  
& Maintained the other



Dimensions are shown: Inches (mm)  
Specifications and dimensions subject to change

# JSM Series Sub-Miniature Slide Switches

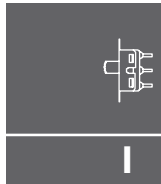

Slide

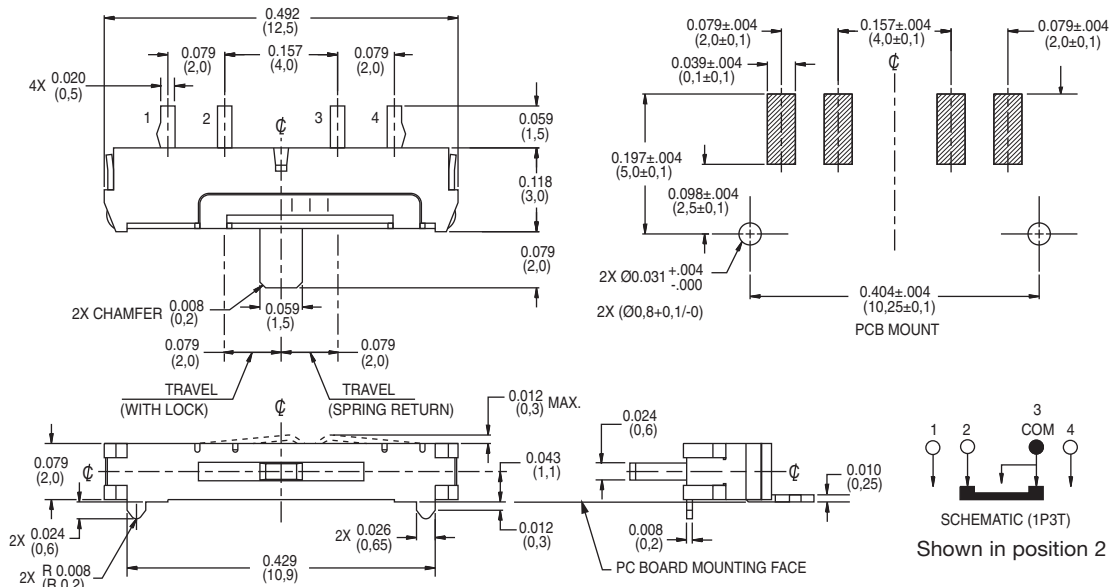

JSM07011SAQNL  
SP3T Surface Mount  
Momentary one side  
& Maintained the other

Packaging for JSM07011SAQNR and JSM07011SAQNL

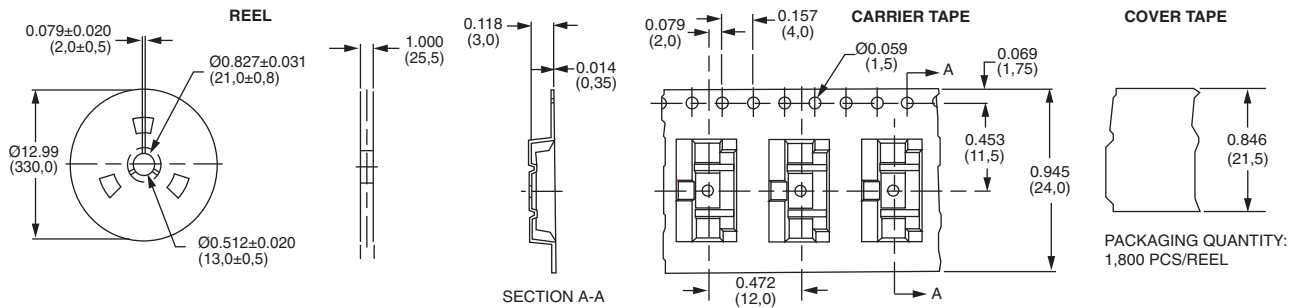

Dimensions are shown: Inch (mm)  
Specifications and dimensions subject to change

# JSM Series Sub-Miniature Slide Switches

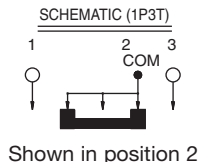
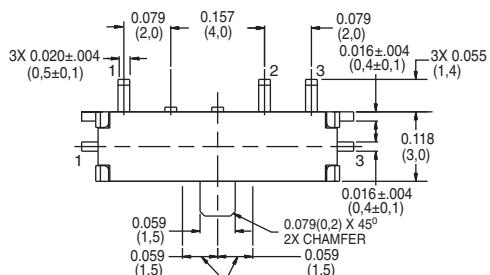

JSM05000SAQN  
SP3T Surface Mount  
Momentary both  
sides

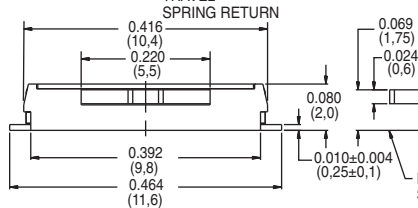

RECOMMENDED PC BOARD LAY OUT  
SCALE 5:1

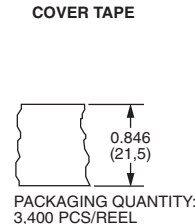
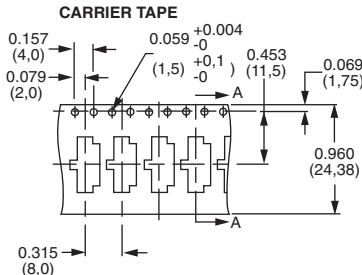
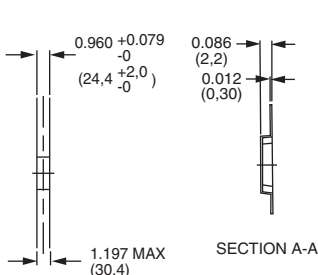
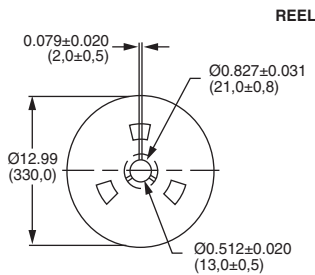
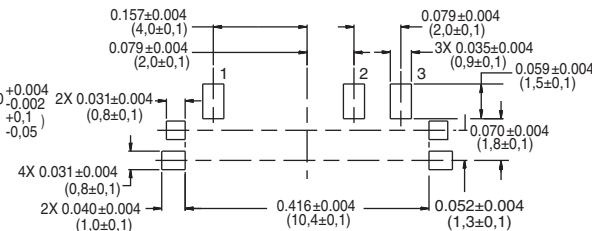

PACKAGING QUANTITY:  
3,400 PCS/REEL

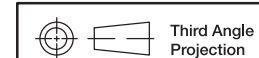

Dimensions are shown: Inches (mm)  
Specifications and dimensions subject to change

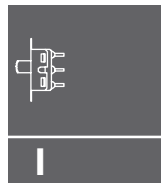

Side



Компания «ЭлектроПласт» предлагает заключение долгосрочных отношений при поставках импортных электронных компонентов на взаимовыгодных условиях!

Наши преимущества:

- Оперативные поставки широкого спектра электронных компонентов отечественного и импортного производства напрямую от производителей и с крупнейших мировых складов;
- Поставка более 17-ти миллионов наименований электронных компонентов;
- Поставка сложных, дефицитных, либо снятых с производства позиций;
- Оперативные сроки поставки под заказ (от 5 рабочих дней);
- Экспресс доставка в любую точку России;
- Техническая поддержка проекта, помощь в подборе аналогов, поставка прототипов;
- Система менеджмента качества сертифицирована по Международному стандарту ISO 9001;
- Лицензия ФСБ на осуществление работ с использованием сведений, составляющих государственную тайну;
- Поставка специализированных компонентов (Xilinx, Altera, Analog Devices, Intersil, Interpoint, Microsemi, Aeroflex, Peregrine, Syfer, Eurofarad, Texas Instrument, Miteq, Cobham, E2V, MA-COM, Hittite, Mini-Circuits, General Dynamics и др.);

Помимо этого, одним из направлений компании «ЭлектроПласт» является направление «Источники питания». Мы предлагаем Вам помощь Конструкторского отдела:

- Подбор оптимального решения, техническое обоснование при выборе компонента;
- Подбор аналогов;
- Консультации по применению компонента;
- Поставка образцов и прототипов;
- Техническая поддержка проекта;
- Защита от снятия компонента с производства.



#### Как с нами связаться

**Телефон:** 8 (812) 309 58 32 (многоканальный)

**Факс:** 8 (812) 320-02-42

**Электронная почта:** [org@eplast1.ru](mailto:org@eplast1.ru)

**Адрес:** 198099, г. Санкт-Петербург, ул. Калинина, дом 2, корпус 4, литера А.