

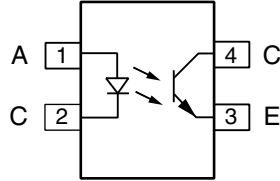

Optocoupler, Phototransistor Output, High Reliability, 5300 V_{RMS}

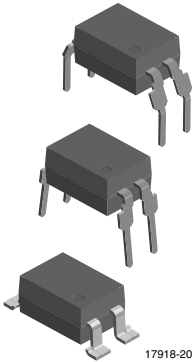

FEATURES

- Excellent CTR linearity depending on forward current
- Isolation test voltage, 5300 V_{RMS}
- Fast switching times
- Low CTR degradation
- Low coupling capacitance
- Material categorization:
For definitions of compliance please see www.vishay.com/doc?99912



DESCRIPTION

The SFH615A feature a variety of transfer ratios, low coupling capacitance and high isolation voltage. These couplers have a GaAs infrared diode emitter, which is optically coupled to a silicon planar phototransistor detector, and is incorporated in a plastic DIP-4 package.

The coupling devices are designed for signal transmission between two electrically separated circuits.





The couplers are end-stackable with 2.54 mm lead spacing. Creepage and clearance distances of > 8 mm are achieved with option 6. This version complies with IEC 60950 (DIN VDE 0805) for reinforced insulation up to an operation voltage of 400 V_{RMS} or DC. Specifications subject to change.

APPLICATIONS

- Switchmode power supply
- Telecom
- Battery powered equipment

AGENCY APPROVALS

- UL file no. E52744
- cUL tested to CSA 22.2 bulletin 5A
- DIN EN 60747-5-5 (VDE 0884-5) available with option 1
- BSI EN 60950; EN 60065
- FIMKO
- CQC

| ORDERING INFORMATION | | | | |
|--|--|---|--|---|
| <div style="display: flex; justify-content: space-around; align-items: center;"> <div style="border: 1px solid black; padding: 2px;">S</div> <div style="border: 1px solid black; padding: 2px;">F</div> <div style="border: 1px solid black; padding: 2px;">H</div> <div style="border: 1px solid black; padding: 2px;">6</div> <div style="border: 1px solid black; padding: 2px;">1</div> <div style="border: 1px solid black; padding: 2px;">5</div> <div style="border: 1px solid black; padding: 2px;">A</div> <div style="border: 1px solid black; padding: 2px;">-</div> <div style="border: 1px solid black; padding: 2px;">#</div> <div style="border: 1px solid black; padding: 2px;">X</div> <div style="border: 1px solid black; padding: 2px;">0</div> <div style="border: 1px solid black; padding: 2px;">#</div> <div style="border: 1px solid black; padding: 2px;">#</div> <div style="border: 1px solid black; padding: 2px;">T</div> </div> <p style="text-align: center;">PART NUMBER</p> | <div style="border: 1px solid black; padding: 2px;">#</div> <p style="text-align: center;">CTR BIN</p> | <div style="border: 1px solid black; padding: 2px;">X</div> <div style="border: 1px solid black; padding: 2px;">0</div> <div style="border: 1px solid black; padding: 2px;">#</div> <div style="border: 1px solid black; padding: 2px;">#</div> <p style="text-align: center;">PACKAGE OPTION</p> | <p style="text-align: center;">TAPE AND REEL</p> | <div style="display: flex; justify-content: space-around;"> <div style="text-align: center;"> <p>DIP-4</p>  <p>7.62 mm</p> </div> <div style="text-align: center;"> <p>Option 6</p>  <p>10.16 mm</p> </div> </div> <div style="display: flex; justify-content: space-around; margin-top: 10px;"> <div style="text-align: center;"> <p>Option 7</p>  <p>> 8 mm</p> </div> <div style="text-align: center;"> <p>Option 9</p>  <p>8 mm typ.</p> </div> </div> |
| AGENCY CERTIFIED/PACKAGE | CTR (%) | | | |
| UL, cUL, BSI, FIMKO | 40 to 80 | 63 to 125 | 100 to 200 | 160 to 320 |
| DIP-4 | SFH615A-1 | SFH615A-2 | SFH615A-3 | SFH615A-4 |
| DIP-4, 400 mil, option 6 | SFH615A-1X006 | SFH615A-2X006 | SFH615A-3X006 | - |
| SMD-4, option 7 | - | - | SFH615A-3X007T ⁽¹⁾ | - |
| SMD-4, option 9 | - | SFH615A-2X009T | SFH615A-3X009T ⁽¹⁾ | SFH615A-4X009 |
| UL, cUL, VDE, BSI, FIMKO | 40 to 80 | 63 to 125 | 100 to 200 | 160 to 320 |
| DIP-4 | SFH615A-1X001 | SFH615A-2X001 | SFH615A-3X001 | SFH615A-4X001 |
| DIP-4, 400 mil, option 6 | SFH615A-1X016 | SFH615A-2X016 | SFH615A-3X016 | SFH615A-4X016 |
| SMD-4, option 7 | SFH615A-1X017T ⁽¹⁾ | SFH615A-2X017T ⁽¹⁾ | SFH615A-3X017 | SFH615A-4X017T ⁽¹⁾ |
| SMD-4, option 9 | - | SFH615A-2X019T | - | - |
| | | SFH615A-2X019T3 ⁽²⁾ | | |

Notes

- Additional options may be possible, please contact sales office.
- ⁽¹⁾ Also available in tubes; do not add T to end.
- ⁽²⁾ T3 rotation in tape and reel packaging.



| ABSOLUTE MAXIMUM RATINGS (T _{amb} = 25 °C, unless otherwise specified) | | | | |
|---|--|-------------------|--------------------|------------------|
| PARAMETER | TEST CONDITION | SYMBOL | VALUE | UNIT |
| INPUT | | | | |
| Reverse voltage | | V _R | 6 | V |
| DC forward current | | I _F | 60 | mA |
| Forward surge current | t _p ≤ 10 μs | I _{FSM} | 2.5 | A |
| LED power dissipation | at 25 °C | P _{diss} | 70 | mW |
| OUTPUT | | | | |
| Collector emitter voltage | | V _{CEO} | 70 | V |
| Emitter collector voltage | | V _{ECO} | 7 | V |
| Collector current | | I _C | 50 | mA |
| Collector peak current | t _p /T = 0.5, t _p ≤ 10 ms | I _{CM} | 100 | mA |
| Output power dissipation | at 25 °C | P _{diss} | 150 | mW |
| COUPLER | | | | |
| Isolation test voltage between emitter and detector | t = 1 s | V _{ISO} | 5300 | V _{RMS} |
| Creepage distance | | | ≥ 7 | mm |
| Clearance distance | | | ≥ 7 | mm |
| Isolation thickness between emitter and detector | | | ≥ 0.4 | mm |
| Comparative tracking index per DIN IEC 112/VDE 0303, part 1 | | CTI | ≥ 175 | |
| Isolation resistance | V _{IO} = 500 V, T _{amb} = 25 °C | R _{IO} | ≥ 10 ¹² | Ω |
| | V _{IO} = 500 V, T _{amb} = 100 °C | R _{IO} | ≥ 10 ¹¹ | Ω |
| Operation temperature | | T _{amb} | -55 to +100 | °C |
| Storage temperature range | | T _{stg} | -55 to +150 | °C |
| Soldering temperature ⁽¹⁾ | 2 mm from case, ≤ 10 s | T _{slid} | 260 | °C |

Notes

- Stresses in excess of the absolute maximum ratings can cause permanent damage to the device. Functional operation of the device is not implied at these or any other conditions in excess of those given in the operational sections of this document. Exposure to absolute maximum ratings for extended periods of the time can adversely affect reliability.

⁽¹⁾ Refer to reflow profile for soldering conditions for surface mounted devices (SMD). Refer to wave profile for soldering conditions for through hole devices (DIP).

| ELECTRICAL CHARACTERISTICS (T _{amb} = 25 °C, unless otherwise specified) | | | | | | | |
|---|-----------------------------------|-----------|--------------------|------|------|------|------|
| PARAMETER | TEST CONDITION | PART | SYMBOL | MIN. | TYP. | MAX. | UNIT |
| INPUT | | | | | | | |
| Forward voltage | I _F = 60 mA | | V _F | | 1.35 | 1.65 | V |
| Reverse current | V _R = 6 V | | I _R | | 0.01 | 10 | μA |
| Capacitance | V _R = 0 V, f = 1 MHz | | C _O | | 13 | | pF |
| OUTPUT | | | | | | | |
| Collector emitter capacitance | V _{CE} = 5 V, f = 1 MHz | | C _{CE} | | 5.2 | | pF |
| Collector emitter leakage current | V _{CE} = 10 V | SFH615A-1 | I _{CEO} | | 2 | 50 | nA |
| | | SFH615A-2 | I _{CEO} | | 2 | 50 | nA |
| | | SFH615A-3 | I _{CEO} | | 5 | 100 | nA |
| | | SFH615A-4 | I _{CEO} | | 5 | 100 | nA |
| COUPLER | | | | | | | |
| Collector emitter saturation voltage | I _F = 10 mA, f = 1 MHz | | V _{CEsat} | | 0.25 | 0.4 | V |
| Coupling capacitance | | | C _C | | 0.4 | | pF |

Note

- Minimum and maximum values are testing requirements. Typical values are characteristics of the device and are the result of engineering evaluation. Typical values are for information only and are not part of the testing requirements.



| CURRENT TRANSFER RATIO ($T_{amb} = 25\text{ }^{\circ}\text{C}$, unless otherwise specified) | | | | | | | |
|--|--|-----------|--------|------|------|------|------|
| PARAMETER | TEST CONDITION | PART | SYMBOL | MIN. | TYP. | MAX. | UNIT |
| I_C/I_F | $I_F = 10\text{ mA}$, $V_{CE} = 5\text{ V}$ | SFH615A-1 | CTR | 40 | | 80 | % |
| | | SFH615A-2 | CTR | 63 | | 125 | % |
| | | SFH615A-3 | CTR | 100 | | 200 | % |
| | | SFH615A-4 | CTR | 160 | | 320 | % |
| | $I_F = 1\text{ mA}$, $V_{CE} = 5\text{ V}$ | SFH615A-1 | CTR | 13 | 30 | | % |
| | | SFH615A-2 | CTR | 22 | 45 | | % |
| | | SFH615A-3 | CTR | 34 | 70 | | % |
| | | SFH615A-4 | CTR | 56 | 90 | | % |

| SWITCHING CHARACTERISTICS ($T_{amb} = 25\text{ }^{\circ}\text{C}$, unless otherwise specified) | | | | | | | |
|---|---|-----------|-----------|------|------|------|---------------|
| PARAMETER | TEST CONDITION | PART | SYMBOL | MIN. | TYP. | MAX. | UNIT |
| NON-SATURATED | | | | | | | |
| Turn-on time | $I_F = 10\text{ mA}$, $V_{CC} = 5\text{ V}$, $R_L = 75\text{ }\Omega$ | | t_{on} | | 3 | | μs |
| Rise time | $I_F = 10\text{ mA}$, $V_{CC} = 5\text{ V}$, $R_L = 75\text{ }\Omega$ | | t_r | | 2 | | μs |
| Turn-off time | $I_F = 10\text{ mA}$, $V_{CC} = 5\text{ V}$, $R_L = 75\text{ }\Omega$ | | t_{off} | | 2.3 | | μs |
| Fall time | $I_F = 10\text{ mA}$, $V_{CC} = 5\text{ V}$, $R_L = 75\text{ }\Omega$ | | t_f | | 2 | | μs |
| Cut-off frequency | $I_F = 10\text{ mA}$, $V_{CC} = 5\text{ V}$, $R_L = 75\text{ }\Omega$ | | f_{CO} | | 100 | | kHz |
| SATURATED | | | | | | | |
| Turn-on time | $I_F = 20\text{ mA}$ | SFH615A-1 | t_{on} | | 3 | | μs |
| | $I_F = 10\text{ mA}$ | SFH615A-2 | t_{on} | | 4.2 | | μs |
| | | SFH615A-3 | t_{on} | | 4.2 | | μs |
| | $I_F = 5\text{ mA}$ | SFH615A-4 | t_{on} | | 6 | | μs |
| Rise time | $I_F = 20\text{ mA}$ | SFH615A-1 | t_r | | 2 | | μs |
| | $I_F = 10\text{ mA}$ | SFH615A-2 | t_r | | 3 | | μs |
| | | SFH615A-3 | t_r | | 3 | | μs |
| | $I_F = 5\text{ mA}$ | SFH615A-4 | t_r | | 4 | | μs |
| Turn-off time | $I_F = 20\text{ mA}$ | SFH615A-1 | t_{off} | | 18 | | μs |
| | $I_F = 10\text{ mA}$ | SFH615A-2 | t_{off} | | 23 | | μs |
| | | SFH615A-3 | t_{off} | | 23 | | μs |
| | $I_F = 5\text{ mA}$ | SFH615A-4 | t_{off} | | 25 | | μs |
| Fall time | $I_F = 20\text{ mA}$ | SFH615A-1 | t_f | | 11 | | μs |
| | $I_F = 10\text{ mA}$ | SFH615A-2 | t_f | | 14 | | μs |
| | | SFH615A-3 | t_f | | 14 | | μs |
| | $I_F = 5\text{ mA}$ | SFH615A-4 | t_f | | 15 | | μs |

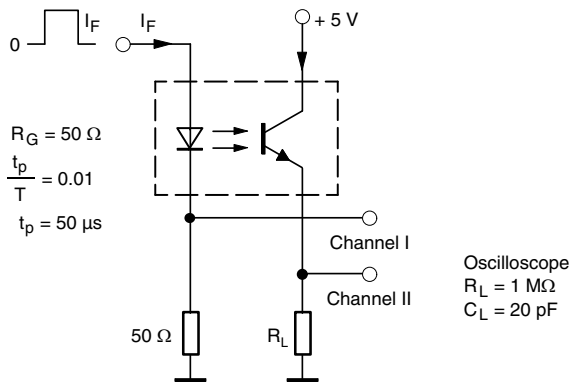

95 10804-3

Fig. 1 - Test Circuit, Non-Saturated Operation

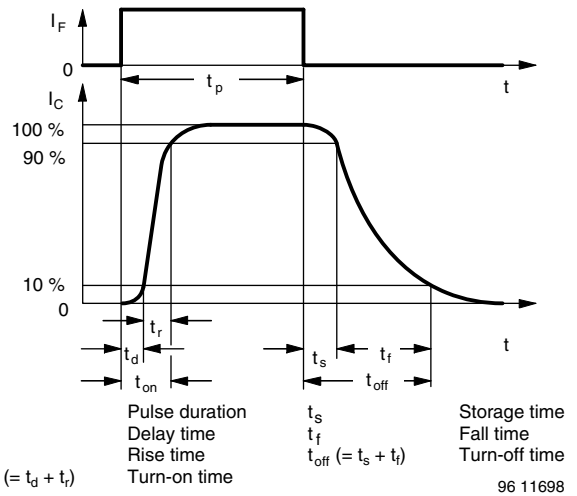
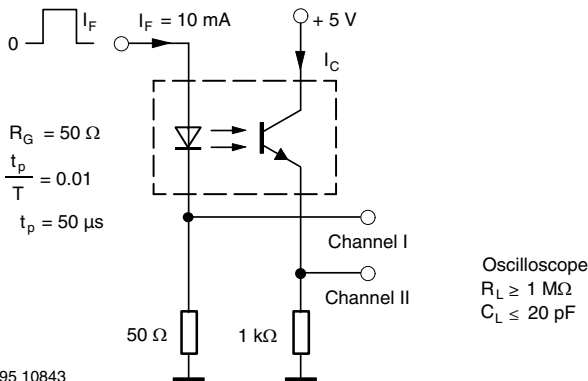

Fig. 3 - Switching Times



95 10843

Fig. 2 - Test Circuit, Saturated Operation

| SAFETY AND INSULATION RATINGS | | | | | | |
|--|------------------------|------------|------|-----------|------|------|
| PARAMETER | TEST CONDITION | SYMBOL | MIN. | TYP. | MAX. | UNIT |
| Climatic classification (according to IEC 68 part 1) | | | | 55/100/21 | | |
| Comparative tracking index | | CTI | 175 | | 399 | |
| Rated impulse voltage | | V_{IOTM} | | | 8 | kV |
| Maximum working voltages | Recurring peak voltage | V_{IORM} | | | 890 | V |
| Forward current | | I_{SI} | | | 275 | mA |
| Power dissipation | | P_{SO} | | | 400 | mW |
| Safety temperature | | T_{SI} | | | 175 | °C |
| Creepage distance | | | 7.0 | | | mm |
| Clearance distance | | | 7.0 | | | mm |
| Isolation distance | per IEC 60950 2.10.5.1 | | 0.4 | | | mm |

Note

- According to DIN EN 60747-5-5 (VDE 0884-5). These optocouplers are suitable for “safe electrical insulation” only within the safety ratings. Compliance with the safety ratings shall be ensured by means of protective circuits.

TYPICAL CHARACTERISTICS ($T_{amb} = 25\text{ }^{\circ}\text{C}$, unless otherwise specified)

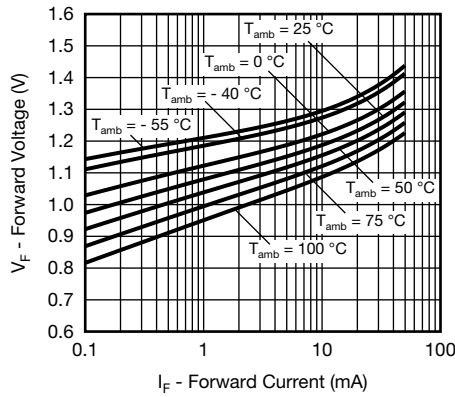

Fig. 4 - Forward Voltage vs. Forward Current

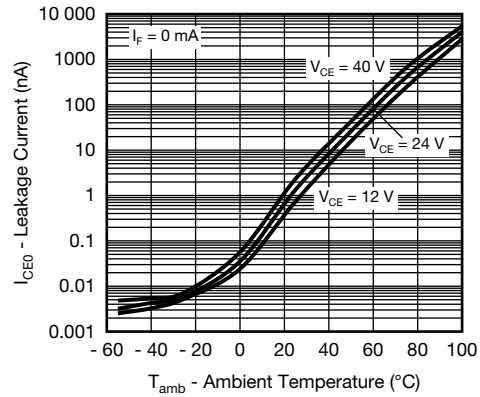

Fig. 7 - Leakage Current vs. Ambient Temperature

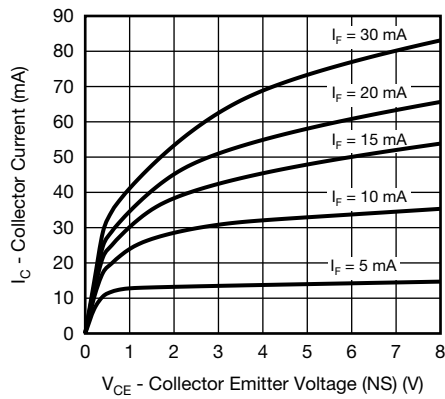

Fig. 5 - Collector Current vs. Collector Emitter Voltage (NS)

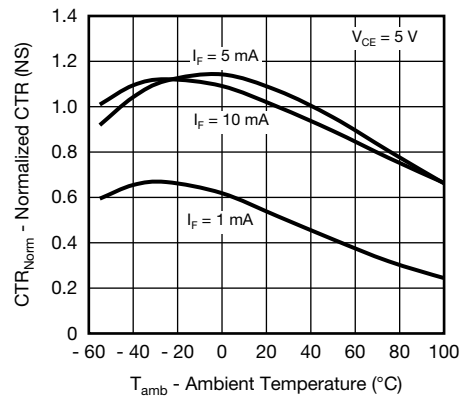

Fig. 8 - Normalized CTR (NS) vs. Ambient Temperature

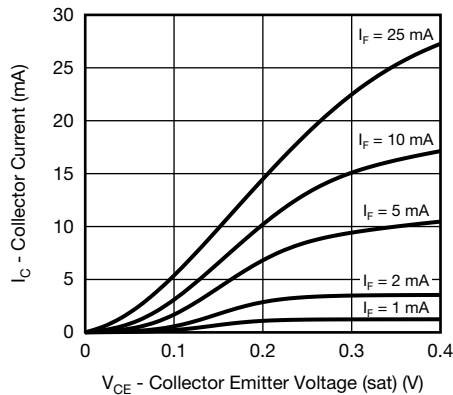

Fig. 6 - Collector Current vs. Collector Emitter Voltage (sat)

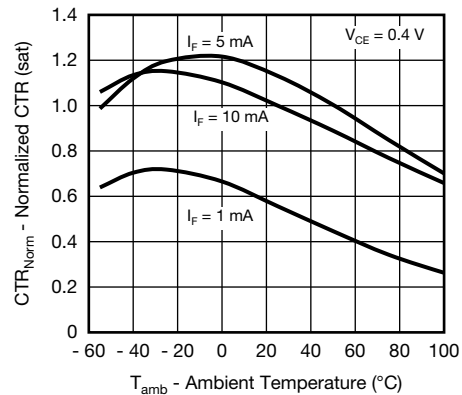

Fig. 9 - Normalized CTR (sat) vs. Ambient Temperature

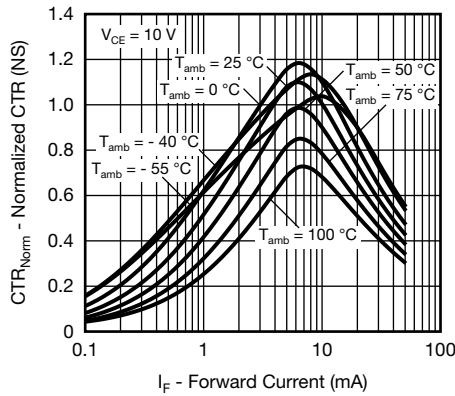

Fig. 10 - Normalized CTR (NS) vs. Forward Current

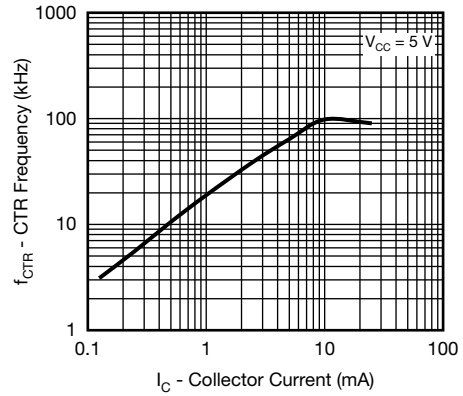

Fig. 13 - CTR Frequency vs. Collector Current

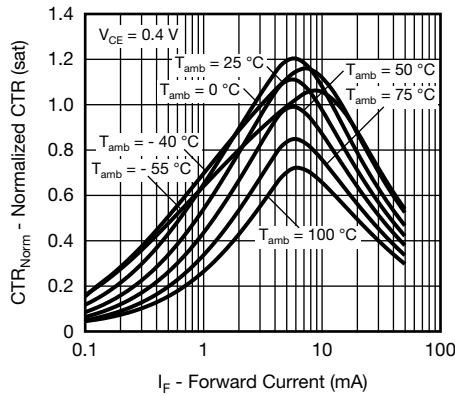

Fig. 11 - Normalized CTR (sat) vs. Forward Current

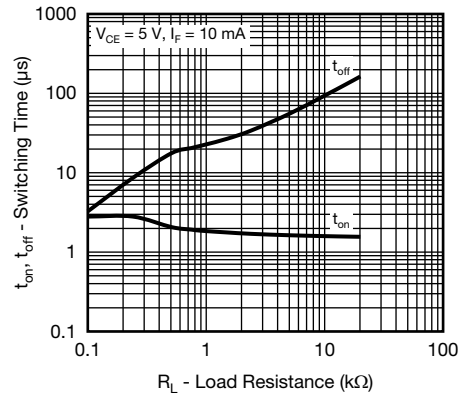

Fig. 14 - Switching Time vs. Load Resistance

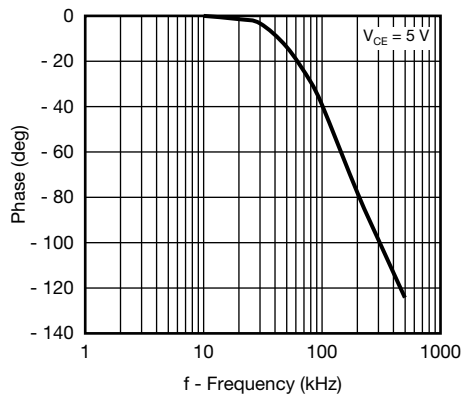
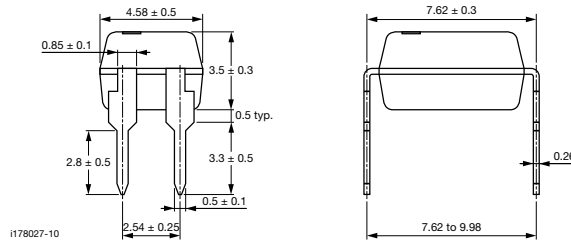
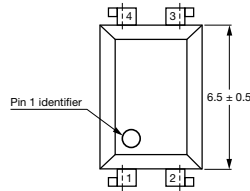

Fig. 12 - CTR Frequency vs. Phase Angle



PACKAGE DIMENSIONS in millimeters



Option 6

Option 7

Option 9

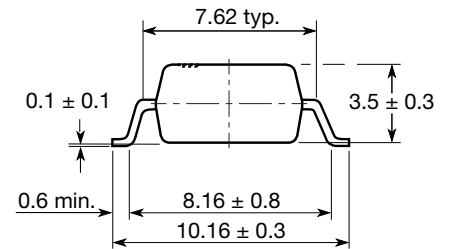
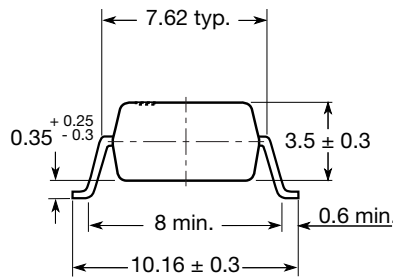
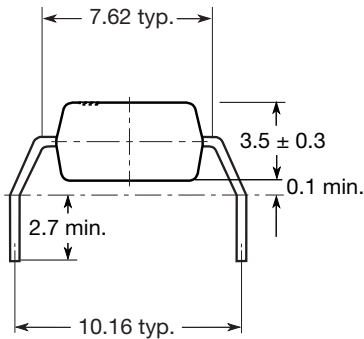

20802-28

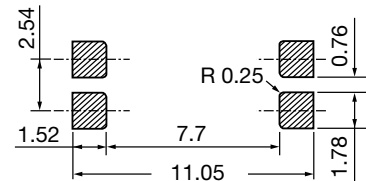
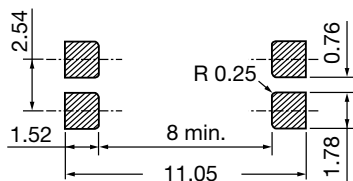

PACKAGE MARKING (Example)

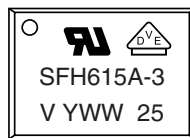

Notes

- VDE logo is only marked on option 1 parts. Option information is not marked on the part.
- Tape and reel suffix (T) is not part of the package marking.

PACKING INFORMATION

| DEVICE PER TUBE | | | |
|-----------------|------------|-----------|-----------|
| TYPE | UNITS/TUBE | TUBES/BOX | UNITS/BOX |
| DIP-4 | 100 | 40 | 4000 |

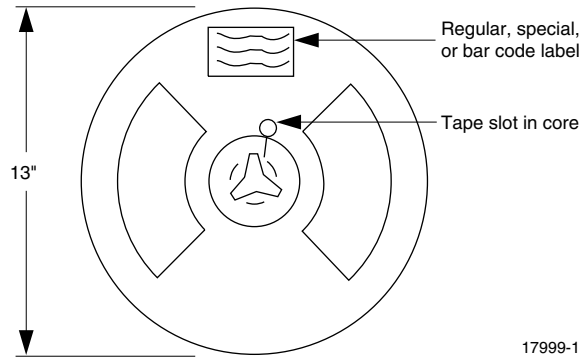

Fig. 15 - Tape and Reel Shipping Medium

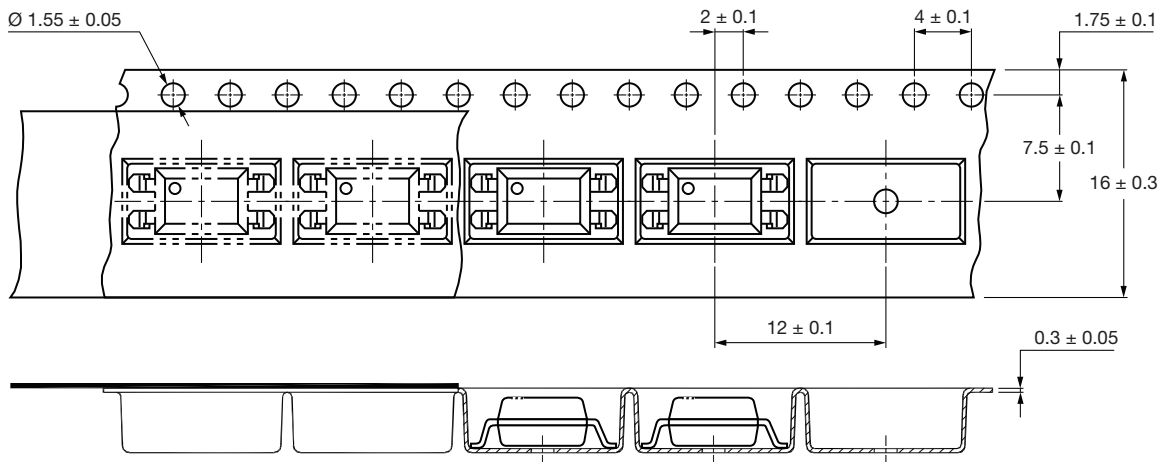

Fig. 16 - Tape and Packing for Option 7 and Option 9

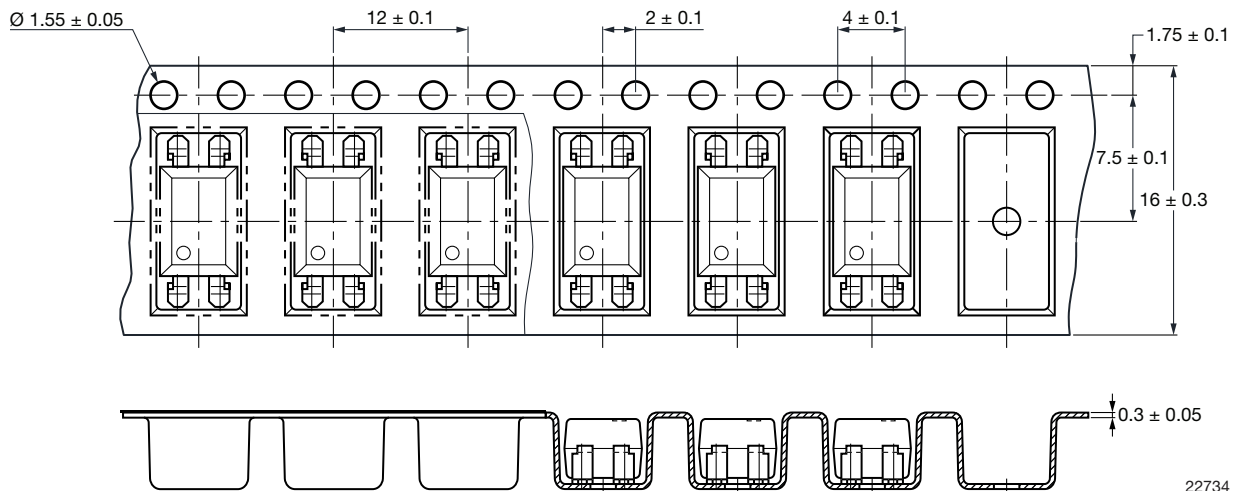

Fig. 17 - Tape Packing for Option 7 and Option 9, T3 Rotation (2000 units per reel)



Disclaimer

ALL PRODUCT, PRODUCT SPECIFICATIONS AND DATA ARE SUBJECT TO CHANGE WITHOUT NOTICE TO IMPROVE RELIABILITY, FUNCTION OR DESIGN OR OTHERWISE.

Vishay Intertechnology, Inc., its affiliates, agents, and employees, and all persons acting on its or their behalf (collectively, "Vishay"), disclaim any and all liability for any errors, inaccuracies or incompleteness contained in any datasheet or in any other disclosure relating to any product.

Vishay makes no warranty, representation or guarantee regarding the suitability of the products for any particular purpose or the continuing production of any product. To the maximum extent permitted by applicable law, Vishay disclaims (i) any and all liability arising out of the application or use of any product, (ii) any and all liability, including without limitation special, consequential or incidental damages, and (iii) any and all implied warranties, including warranties of fitness for particular purpose, non-infringement and merchantability.

Statements regarding the suitability of products for certain types of applications are based on Vishay's knowledge of typical requirements that are often placed on Vishay products in generic applications. Such statements are not binding statements about the suitability of products for a particular application. It is the customer's responsibility to validate that a particular product with the properties described in the product specification is suitable for use in a particular application. Parameters provided in datasheets and/or specifications may vary in different applications and performance may vary over time. All operating parameters, including typical parameters, must be validated for each customer application by the customer's technical experts. Product specifications do not expand or otherwise modify Vishay's terms and conditions of purchase, including but not limited to the warranty expressed therein.

Except as expressly indicated in writing, Vishay products are not designed for use in medical, life-saving, or life-sustaining applications or for any other application in which the failure of the Vishay product could result in personal injury or death. Customers using or selling Vishay products not expressly indicated for use in such applications do so at their own risk. Please contact authorized Vishay personnel to obtain written terms and conditions regarding products designed for such applications.

No license, express or implied, by estoppel or otherwise, to any intellectual property rights is granted by this document or by any conduct of Vishay. Product names and markings noted herein may be trademarks of their respective owners.

Material Category Policy

Vishay Intertechnology, Inc. hereby certifies that all its products that are identified as RoHS-Compliant fulfill the definitions and restrictions defined under Directive 2011/65/EU of The European Parliament and of the Council of June 8, 2011 on the restriction of the use of certain hazardous substances in electrical and electronic equipment (EEE) - recast, unless otherwise specified as non-compliant.

Please note that some Vishay documentation may still make reference to RoHS Directive 2002/95/EC. We confirm that all the products identified as being compliant to Directive 2002/95/EC conform to Directive 2011/65/EU.

Vishay Intertechnology, Inc. hereby certifies that all its products that are identified as Halogen-Free follow Halogen-Free requirements as per JEDEC JS709A standards. Please note that some Vishay documentation may still make reference to the IEC 61249-2-21 definition. We confirm that all the products identified as being compliant to IEC 61249-2-21 conform to JEDEC JS709A standards.



Компания «ЭлектроПласт» предлагает заключение долгосрочных отношений при поставках импортных электронных компонентов на взаимовыгодных условиях!

Наши преимущества:

- Оперативные поставки широкого спектра электронных компонентов отечественного и импортного производства напрямую от производителей и с крупнейших мировых складов;
- Поставка более 17-ти миллионов наименований электронных компонентов;
- Поставка сложных, дефицитных, либо снятых с производства позиций;
- Оперативные сроки поставки под заказ (от 5 рабочих дней);
- Экспресс доставка в любую точку России;
- Техническая поддержка проекта, помощь в подборе аналогов, поставка прототипов;
- Система менеджмента качества сертифицирована по Международному стандарту ISO 9001;
- Лицензия ФСБ на осуществление работ с использованием сведений, составляющих государственную тайну;
- Поставка специализированных компонентов (Xilinx, Altera, Analog Devices, Intersil, Interpoint, Microsemi, Aeroflex, Peregrine, Syfer, Eurofarad, Texas Instrument, Miteq, Cobham, E2V, MA-COM, Hittite, Mini-Circuits, General Dynamics и др.);

Помимо этого, одним из направлений компании «ЭлектроПласт» является направление «Источники питания». Мы предлагаем Вам помощь Конструкторского отдела:

- Подбор оптимального решения, техническое обоснование при выборе компонента;
- Подбор аналогов;
- Консультации по применению компонента;
- Поставка образцов и прототипов;
- Техническая поддержка проекта;
- Защита от снятия компонента с производства.



Как с нами связаться

Телефон: 8 (812) 309 58 32 (многоканальный)

Факс: 8 (812) 320-02-42

Электронная почта: org@eplast1.ru

Адрес: 198099, г. Санкт-Петербург, ул. Калинина, дом 2, корпус 4, литера А.