

**SINGLE LOW VOLTAGE RAIL-TO-RAIL OUTPUT OPERATIONAL AMPLIFIER      AZV321**

**General Description**

The AZV321 is single low voltage (2.7-5.5V) operational amplifier which has rail-to-rail output swing capability. The input common-mode voltage range includes ground. The chip exhibits excellent speed-power ratio, achieving 1MHz of bandwidth and 1V/ $\mu$ s of slew rate with low supply current.

The AZV321 is built with BiCMOS process. It has bipolar input and output stages for improved noise performance, low input offset and higher output current drive.

AZV321 is available in the package of SC-70-5, which is approximately half the size of SOT-23-5. The small package saves space on pc boards, and enables the design of small portable electronic devices. It also allows the designer to place the device closer to the signal source to reduce noise pickup and increase signal integrity.

AZV321 is also available in standard SOT-23-5 package.

**Features**

(For  $V_{CC}=5V$  and  $V_{EE}=0V$ , Typical unless Otherwise Noted)

- Guaranteed 2.7V to 5.5V Performance
- No Crossover Distortion
- Gain-Bandwidth Product 1MHz
- Industrial Temperature Range: -40°C to +85°C
- Low Supply Current: 130 $\mu$ A
- Rail-to-Rail Output Swing under 10k $\Omega$  Load:  
 $V_{OH}$  up to  $V_{CC} -10mV$   
 $V_{OL}$  near to  $V_{EE} +65mV$
- $V_{CM}$ : -0.1V to  $V_{CC}-0.8V$

**Applications**

- Active Filters
- Low Power, Low Voltage Applications
- General Purpose Portable Devices
- Cellular Phone, Cordless Phone
- Battery-Powered Systems

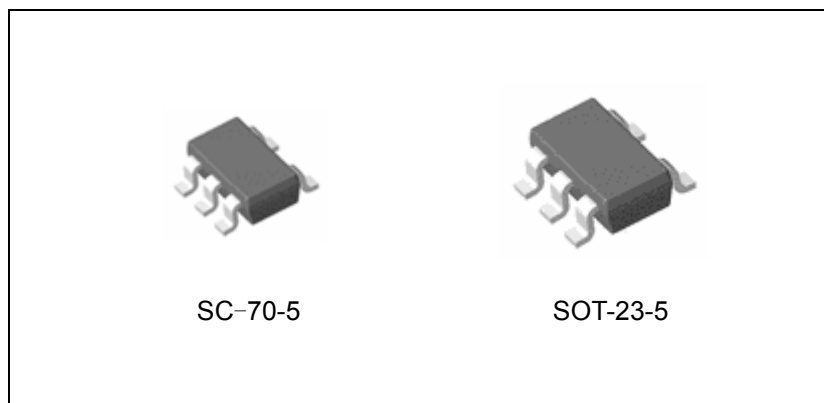

Figure 1. Package Types of AZV321

**SINGLE LOW VOLTAGE RAIL-TO-RAIL OUTPUT OPERATIONAL AMPLIFIER      AZV321**

**Pin Configuration**

KS/K Package  
(SC-70-5/SOT-23-5)

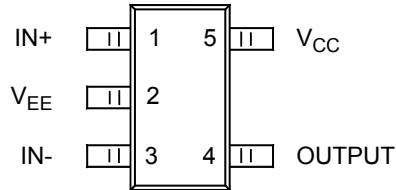

Figure 2. Pin Configuration of AZV321 (Top View)

**Functional Block Diagram**

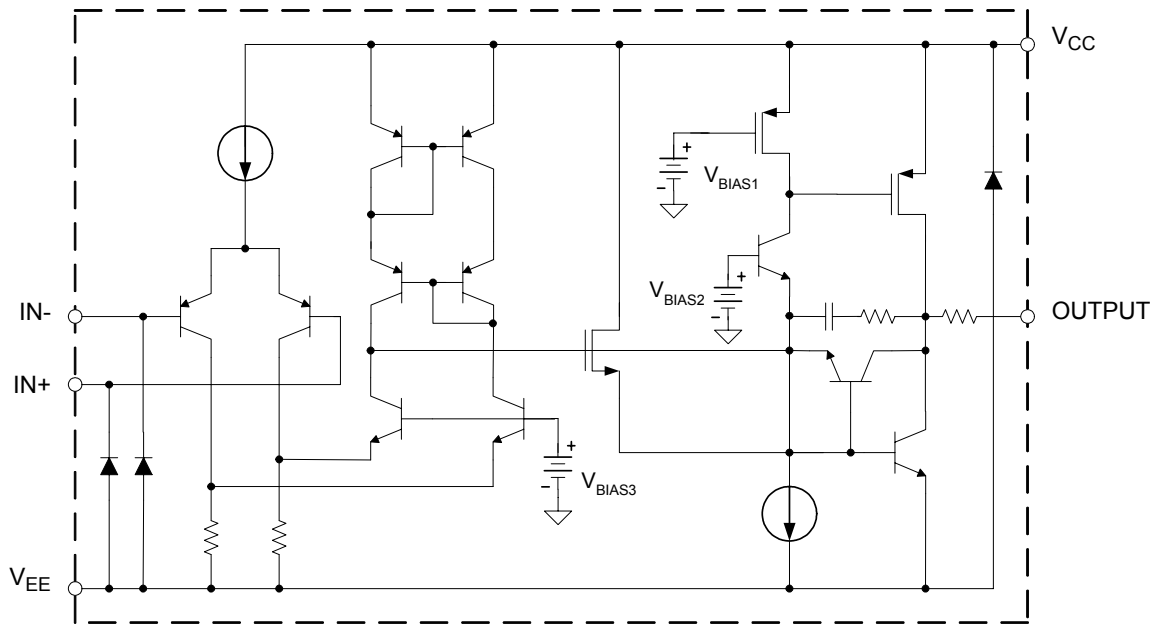

Figure 3. Functional Block Diagram of AZV321





**SINGLE LOW VOLTAGE RAIL-TO-RAIL OUTPUT OPERATIONAL AMPLIFIER AZV321**

**2.7V Electrical Characteristics**

All limits are guaranteed for  $T_A=25^{\circ}\text{C}$ ,  $V_{CC}=2.7\text{V}$ ,  $V_{EE}=0\text{V}$ ,  $V_{CM}=1.0\text{V}$ ,  $V_O=V_{CC}/2$  and  $R_L>1\text{M}\Omega$ , limits in **bold types** are guaranteed for  $T_A=-40$  to  $85^{\circ}\text{C}$ , unless otherwise specified. (Note 2)

Parameter	Symbol	Conditions	Min	Typ	Max	Unit
Input Offset Voltage	$V_{IO}$			1.7	7	mV
					<b>9</b>	
Input Bias Current	$I_B$			11	250	nA
					<b>500</b>	
Input Offset Current	$I_{IO}$			5	50	nA
					<b>150</b>	
Input Common Mode Voltage Range	$V_{CM}$	for $\text{CMRR}\geq 50\text{dB}$	-0.1		1.9	V
Supply Current	$I_{CC}$	$V_O=V_{CC}/2$ , $A_{VCL}=1$ , no load		80	170	$\mu\text{A}$
					<b>270</b>	
Common Mode Rejection Ratio	CMRR	$0\leq V_{CM}\leq 1.7\text{V}$	50	65		dB
Power Supply Rejection Ratio	PSRR	$2.7\text{V}\leq V_{CC}\leq 5\text{V}$ , $V_O=1\text{V}$ ,	50	60		dB
Output Short Circuit Current	$I_{SOURCE}$	$V_O=0\text{V}$	5	20		mA
	$I_{SINK}$	$V_O=2.7\text{V}$	10	30		mA
Output Voltage Swing	$V_{OH}$	$R_L=10\text{k}\Omega$ to $1.35\text{V}$	2.60	2.69		V
	$V_{OL}$			60	180	mV
Gain Bandwidth Product	GBWP	$C_L=200\text{pF}$		1		MHz
Phase Margin	$\phi_M$			60		Deg
Gain Margin	$G_M$			10		dB

Note 2: Limits over the full temperature are guaranteed by design, but not tested in production.



**SINGLE LOW VOLTAGE RAIL-TO-RAIL OUTPUT OPERATIONAL AMPLIFIER AZV321**

**5V Electrical Characteristics**

All limits are guaranteed for  $T_A=25^{\circ}\text{C}$ ,  $V_{CC}=5\text{V}$ ,  $V_{EE}=0\text{V}$ ,  $V_{CM}=2.0\text{V}$ ,  $V_O=V_{CC}/2$  and  $R_L>1\text{M}\Omega$ , limits in **bold types** are guaranteed for  $T_A=-40$  to  $85^{\circ}\text{C}$ , unless otherwise specified. (Note 2)

Parameter	Symbol	Conditions	Min	Typ	Max	Unit
Input Offset Voltage	$V_{IO}$			1.7	7	mV
					<b>9</b>	
Input Bias Current	$I_B$			11	250	nA
					<b>500</b>	
Input Offset Current	$I_{IO}$			5	50	nA
					<b>150</b>	
Input Common Mode Voltage Range	$V_{CM}$	for $\text{CMRR}\geq 50\text{dB}$	-0.1		4.2	V
Supply Current	$I_{CC}$	$V_O=V_{CC}/2$ , $A_{VCL}=1$ , no load		130	250	$\mu\text{A}$
					<b>350</b>	
Large Signal Voltage Gain	$G_V$	$R_L=2\text{k}\Omega$	84	100		dB
			<b>80</b>			
Common Mode Rejection Ratio	CMRR	$0\leq V_{CM}\leq 4\text{V}$	50	65		dB
Power Supply Rejection Ratio	PSRR	$2.7\text{V}\leq V_{CC}\leq 5\text{V}$ $V_O=1\text{V}$ , $V_{CM}=1\text{V}$	50	60		dB
Output Short Circuit Current	$I_{SOURCE}$	$V_O=0\text{V}$	5	60		mA
	$I_{SINK}$	$V_O=5\text{V}$	10	160		mA
Output Voltage Swing	$V_{OH}$	$R_L=2\text{k}\Omega$ to 2.5V	4.7	4.96		V
			<b>4.6</b>			
		$R_L=10\text{k}\Omega$ to 2.5V	4.9	4.99		
			<b>4.8</b>			
	$V_{OL}$	$R_L=2\text{k}\Omega$ to 2.5V		120	300	mV
					<b>400</b>	
$R_L=10\text{k}\Omega$ to 2.5V			65	180		
				<b>280</b>		
Slew Rate	SR		1		V/ $\mu\text{S}$	
Gain Bandwidth Product	GBWP	$C_L=200\text{pF}$		1		MHz
Phase Margin	$\phi_M$			60		Deg
Gain Margin	$G_M$			10		dB

Note 2: Limits over the full temperature are guaranteed by design, but not tested in production.



**SINGLE LOW VOLTAGE RAIL-TO-RAIL OUTPUT OPERATIONAL AMPLIFIER AZV321**

**Typical Performance Characteristics**

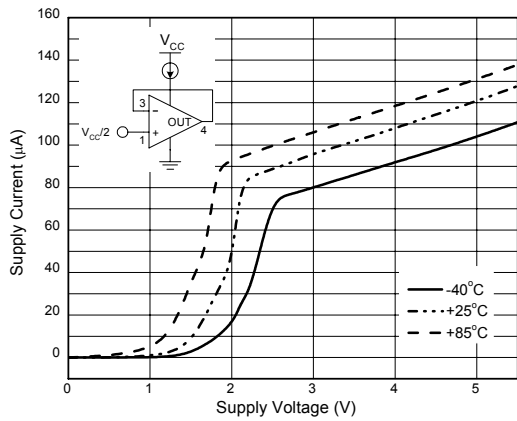

Figure 4. Supply Current vs. Supply Voltage

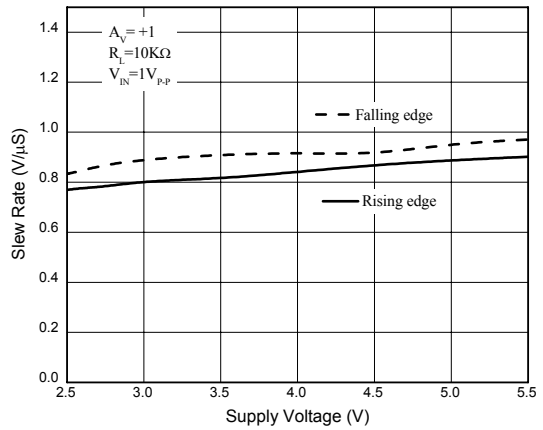

Figure 5. Slew Rate vs. Supply Voltage

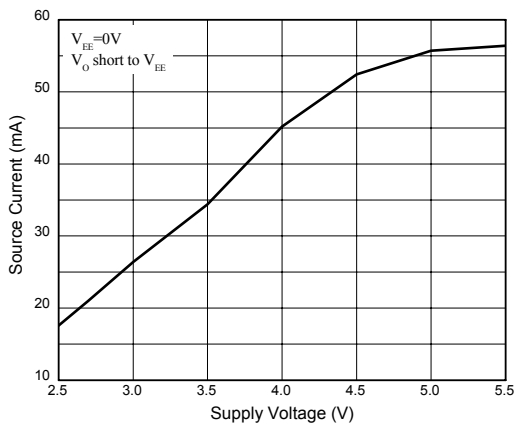

Figure 6. Output Source Current vs. Supply Voltage

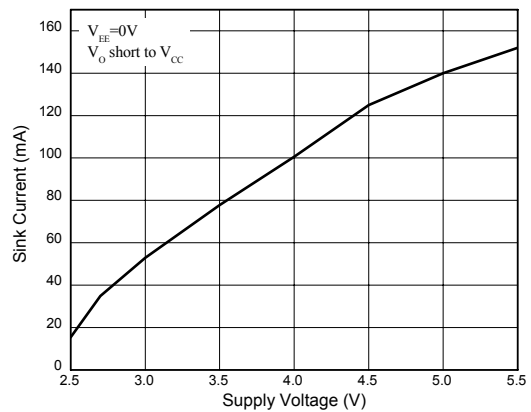

Figure 7. Output Sink Current vs. Supply Voltage



**SINGLE LOW VOLTAGE RAIL-TO-RAIL OUTPUT OPERATIONAL AMPLIFIER      AZV321**

**Typical Performance Characteristics (Continued)**

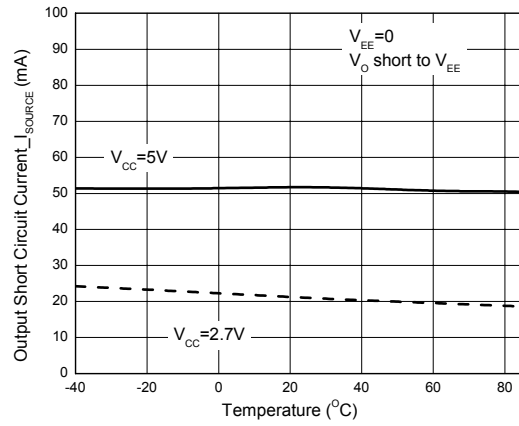
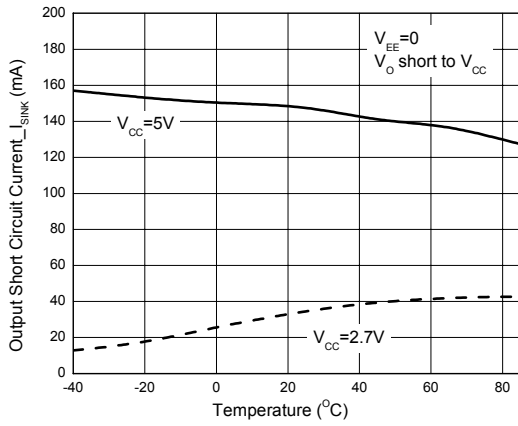

Figure 8. Short Circuit Current<sub>I<sub>SINK</sub></sub> vs. Temperature      Figure 9. Short Circuit Current<sub>I<sub>SOURCE</sub></sub> vs. Temperature

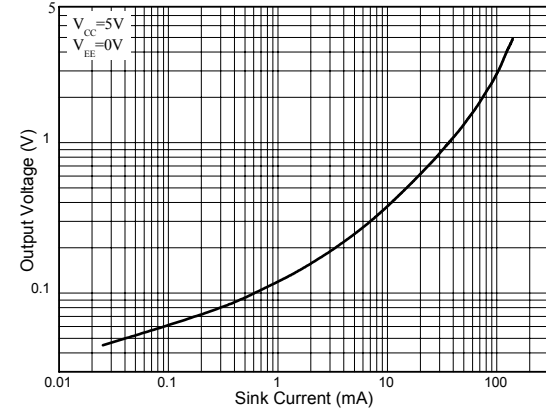
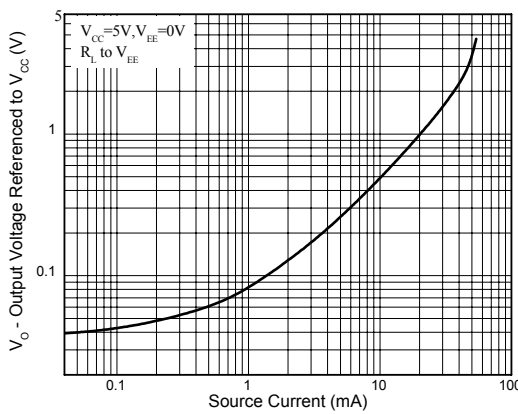

Figure 10. Output Voltage vs. Source Current

Figure 11. Output Voltage vs. Sink Current



**SINGLE LOW VOLTAGE RAIL-TO-RAIL OUTPUT OPERATIONAL AMPLIFIER AZV321**

**Typical Performance Characteristics (Continued)**

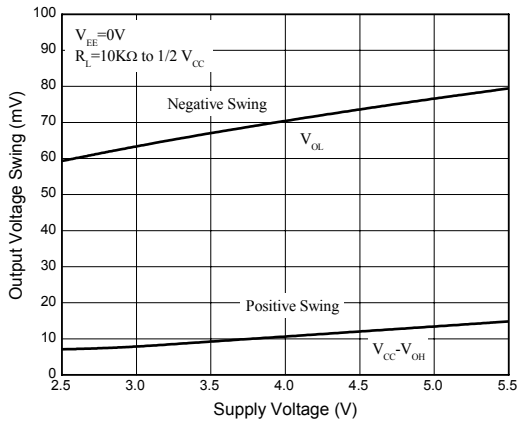

Figure 12. Output Voltage Swing vs. Supply Voltage

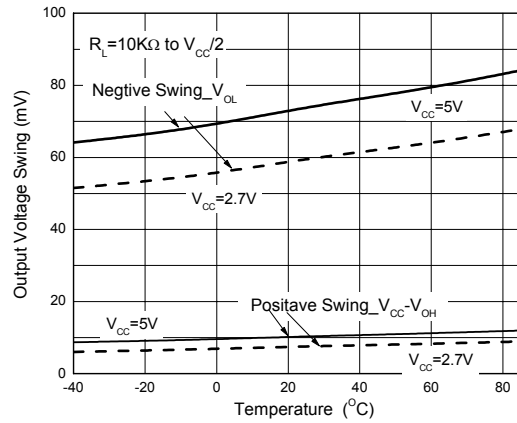

Figure 13. Output Voltage Swing vs. Temperature

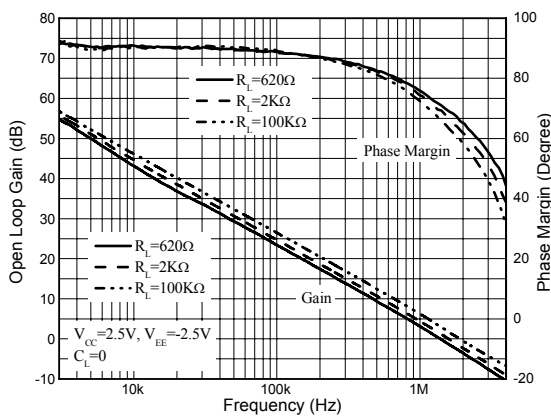

Figure 14. Gain and Phase vs. Frequency and Resistive Load





**SINGLE LOW VOLTAGE RAIL-TO-RAIL OUTPUT OPERATIONAL AMPLIFIER AZV321**

**Typical Performance Characteristics (Continued)**

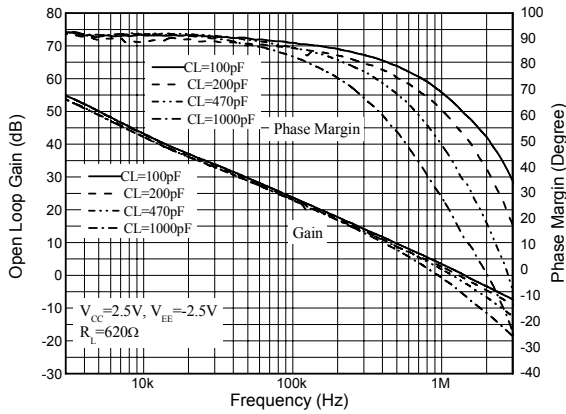

Figure 15. Gain and Phase vs. Frequency and Capacitive Load

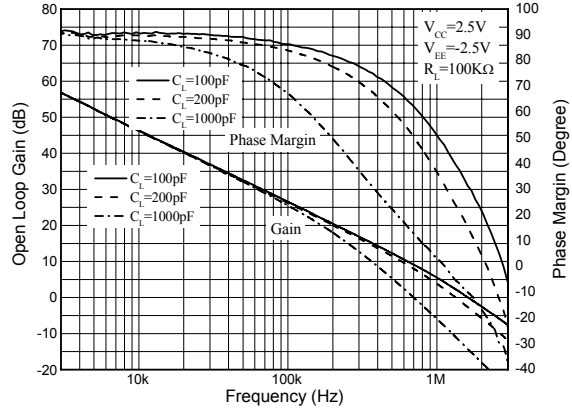

Figure 16. Gain and Phase vs. Frequency and Capacitive Load

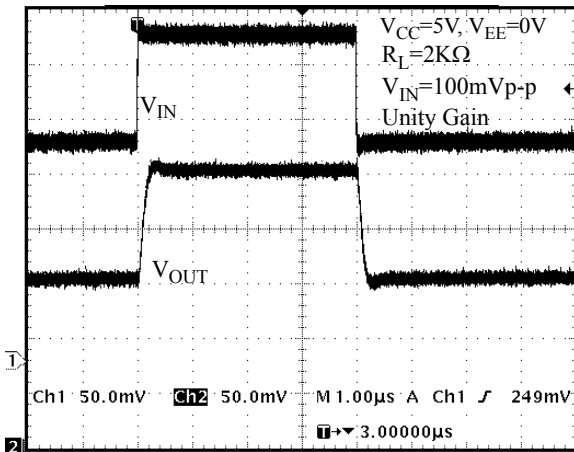

Figure 17. Non-Inverting Input Small Signal Pulse Response

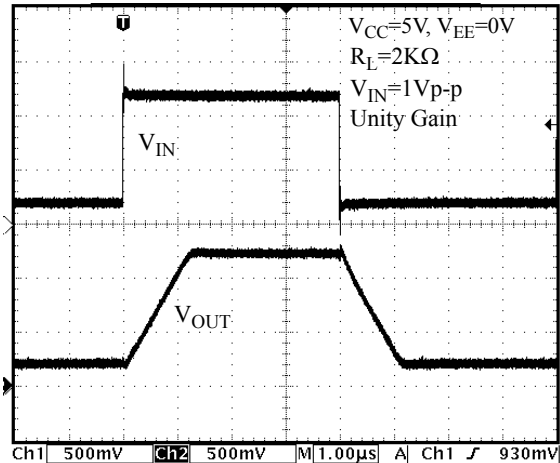

Figure 18. Non-Inverting Input Large Signal Pulse Response

**SINGLE LOW VOLTAGE RAIL-TO-RAIL OUTPUT OPERATIONAL AMPLIFIER AZV321**

**Typical Performance Characteristics (Continued)**

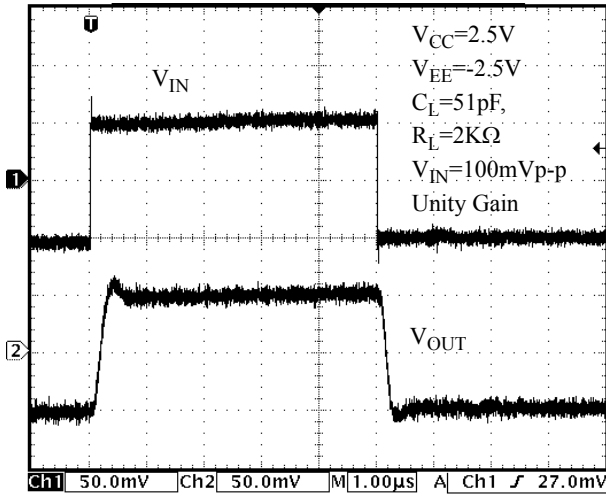

Figure 19. Output with Excessive Capacitive Load

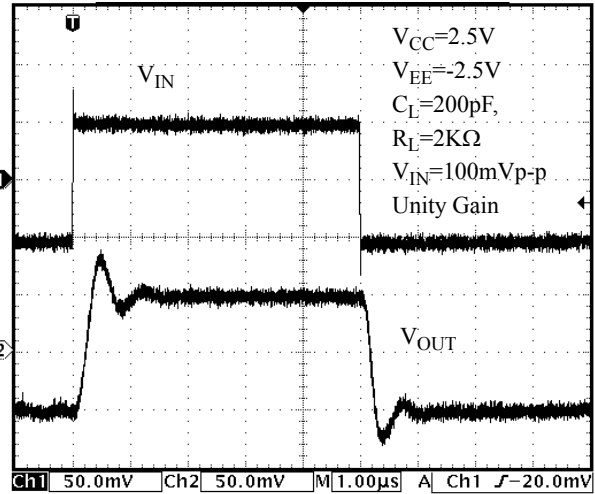

Figure 20. Output with Excessive Capacitive Load

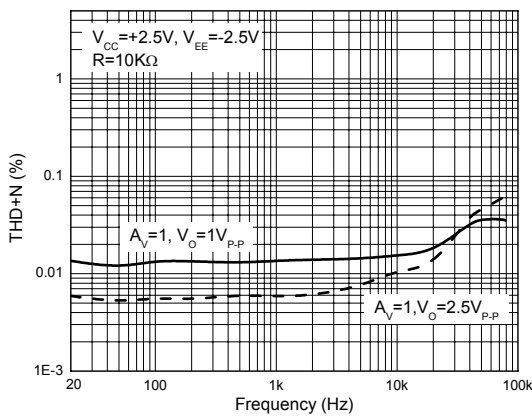

Figure 21. THD+N vs. Frequency



**SINGLE LOW VOLTAGE RAIL-TO-RAIL OUTPUT OPERATIONAL AMPLIFIER      AZV321**

**Mechanical Dimensions**

**SC-70-5**

**Unit: mm(inch)**

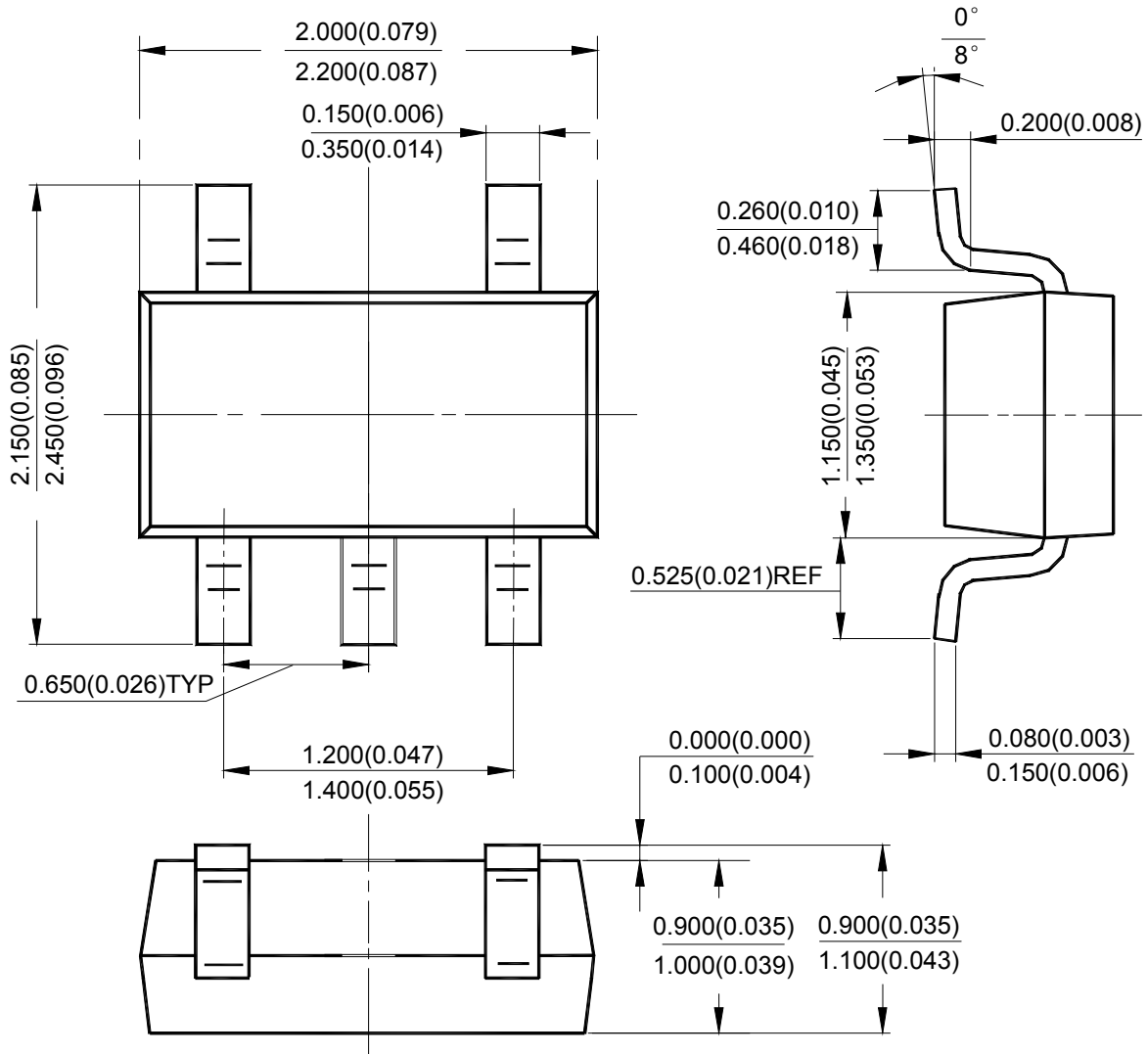



**SINGLE LOW VOLTAGE RAIL-TO-RAIL OUTPUT OPERATIONAL AMPLIFIER      AZV321**

**Mechanical Dimensions**

**SOT-23-5**

**Unit: mm(inch)**

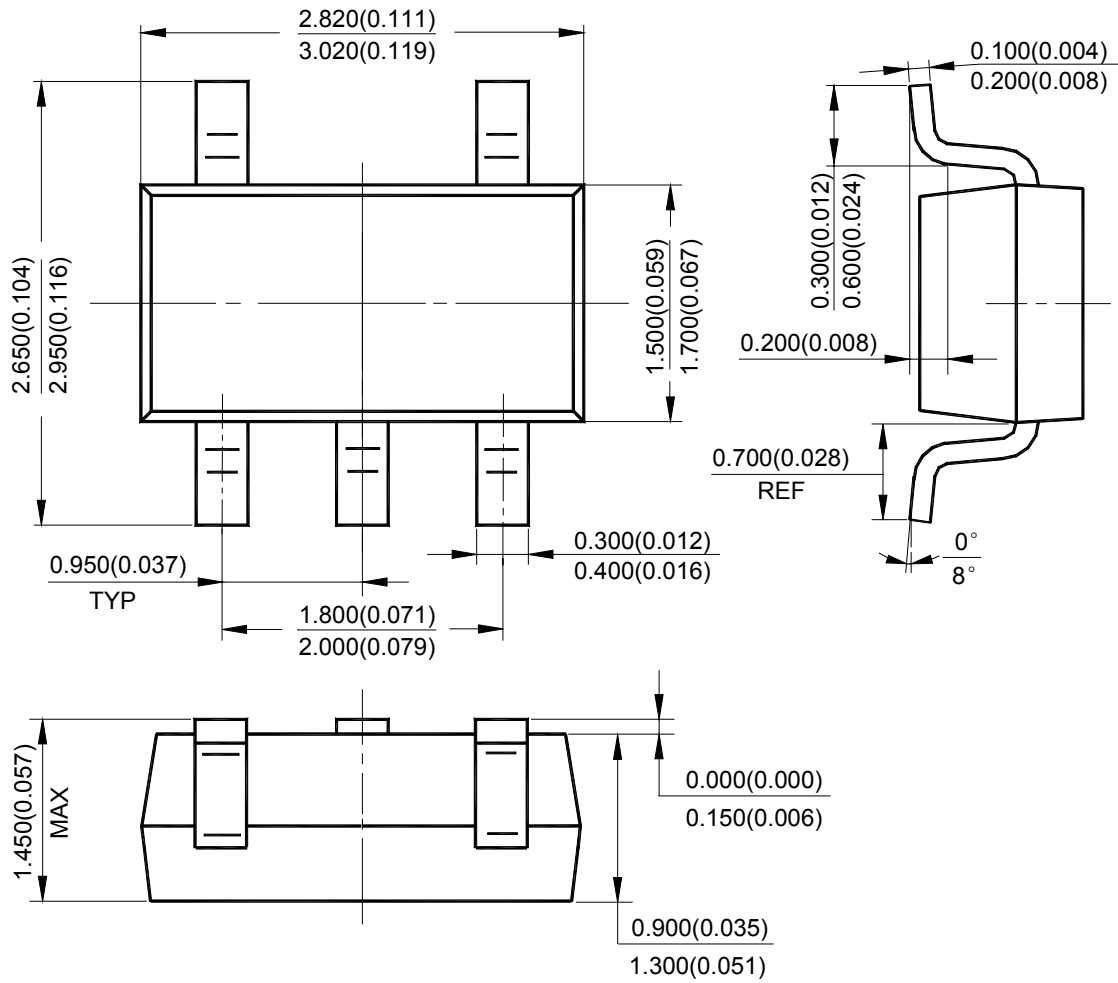



## **BCD Semiconductor Manufacturing Limited**

<http://www.bcdsemi.com>

### **IMPORTANT NOTICE**

BCD Semiconductor Manufacturing Limited reserves the right to make changes without further notice to any products or specifications herein. BCD Semiconductor Manufacturing Limited does not assume any responsibility for use of any its products for any particular purpose, nor does BCD Semiconductor Manufacturing Limited assume any liability arising out of the application or use of any its products or circuits. BCD Semiconductor Manufacturing Limited does not convey any license under its patent rights or other rights nor the rights of others.

---

#### **MAIN SITE**

##### **- Headquarters**

##### **BCD Semiconductor Manufacturing Limited**

No. 1600, Zi Xing Road, Shanghai Zizhu Science-based Industrial Park, 200241, China  
Tel: +86-21-24162266, Fax: +86-21-24162277

##### **- Wafer Fab**

##### **Shanghai SIM-BCD Semiconductor Manufacturing Co., Ltd.**

800 Yi Shan Road, Shanghai 200233, China  
Tel: +86-21-6485 1491, Fax: +86-21-5450 0008

#### **REGIONAL SALES OFFICE**

##### **Shenzhen Office**

##### **Shanghai SIM-BCD Semiconductor Manufacturing Co., Ltd., Shenzhen Office**

Unit A Room 1203, Skyworth Bldg., Gaoxin Ave. 1.S., Nanshan District, Shenzhen, China  
Tel: +86-755-8826 7951  
Fax: +86-755-8826 7865

##### **Taiwan Office**

##### **BCD Semiconductor (Taiwan) Company Limited**

4F, 298-1, Rui Guang Road, Nei-Hu District, Taipei, Taiwan  
Tel: +886-2-2656 2808  
Fax: +886-2-2656 2806

##### **USA Office**

##### **BCD Semiconductor Corp.**

30920 Huntwood Ave. Hayward, CA 94544, USA  
Tel : +1-510-324-2988  
Fax: +1-510-324-2788



Компания «ЭлектроПласт» предлагает заключение долгосрочных отношений при поставках импортных электронных компонентов на взаимовыгодных условиях!

Наши преимущества:

- Оперативные поставки широкого спектра электронных компонентов отечественного и импортного производства напрямую от производителей и с крупнейших мировых складов;
- Поставка более 17-ти миллионов наименований электронных компонентов;
- Поставка сложных, дефицитных, либо снятых с производства позиций;
- Оперативные сроки поставки под заказ (от 5 рабочих дней);
- Экспресс доставка в любую точку России;
- Техническая поддержка проекта, помощь в подборе аналогов, поставка прототипов;
- Система менеджмента качества сертифицирована по Международному стандарту ISO 9001;
- Лицензия ФСБ на осуществление работ с использованием сведений, составляющих государственную тайну;
- Поставка специализированных компонентов (Xilinx, Altera, Analog Devices, Intersil, Interpoint, Microsemi, Aeroflex, Peregrine, Syfer, Eurofarad, Texas Instrument, Miteq, Cobham, E2V, MA-COM, Hittite, Mini-Circuits, General Dynamics и др.);

Помимо этого, одним из направлений компании «ЭлектроПласт» является направление «Источники питания». Мы предлагаем Вам помощь Конструкторского отдела:

- Подбор оптимального решения, техническое обоснование при выборе компонента;
- Подбор аналогов;
- Консультации по применению компонента;
- Поставка образцов и прототипов;
- Техническая поддержка проекта;
- Защита от снятия компонента с производства.



#### Как с нами связаться

**Телефон:** 8 (812) 309 58 32 (многоканальный)

**Факс:** 8 (812) 320-02-42

**Электронная почта:** [org@eplast1.ru](mailto:org@eplast1.ru)

**Адрес:** 198099, г. Санкт-Петербург, ул. Калинина, дом 2, корпус 4, литера А.