

Analog Devices Welcomes Hittite Microwave Corporation

NO CONTENT ON THE ATTACHED DOCUMENT HAS CHANGED



THIS PAGE INTENTIONALLY LEFT BLANK

Typical Applications

The HMC221B(E) is ideal for:

- ISM Applications
- PCMCIA Wireless Cards
- Cellular Applications

Features

- RoHS-Compliant Product
- Low Insertion Loss: 0.4 dB
- Ultra Small Package: SOT26
- Input IP3: +55 dBm
- Positive Control: 0/+3V @ 0.1 μ A

Functional Diagram

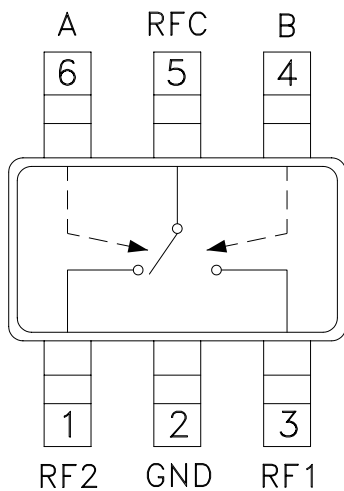

General Description

The HMC221B(E) is a low-cost SPDT switch in a 6-lead SOT26 plastic package for use in general switching applications which require very low insertion loss and very small size. This device can control signals from DC to 3 GHz and is especially suited for 900 MHz, 1.8 - 2.2 GHz, and 2.4 GHz ISM applications with less than 1 dB loss. The design provides exceptional insertion loss performance, ideal for filter and receiver switching. RF1 and RF2 are reflective shorts when "Off". The two control voltages require a minimal amount of DC current and offer compatibility with most CMOS & TTL logic families. See HMC197B(E) for same performance in an alternate SOT26 pin-out.

Electrical Specifications, $T_A = +25^\circ C$, $V_{ctl} = 0/+3$ to $+8 Vdc$

Parameter	Frequency	Min.	Typ.	Max.	Units
Insertion Loss	DC - 1.0 GHz		0.4	0.7	dB
	DC - 2.0 GHz		0.45	0.8	dB
	DC - 2.5 GHz		0.6	0.9	dB
	DC - 3.0 GHz		0.8	1.1	dB
Isolation	DC - 1.0 GHz	24	29		dB
	DC - 2.0 GHz	24	29		dB
	DC - 2.5 GHz	21	25		dB
	DC - 3.0 GHz	14	18		dB
Return Loss	DC - 1.0 GHz	25	33		dB
	DC - 2.0 GHz	20	30		dB
	DC - 2.5 GHz	20	25		dB
	DC - 3.0 GHz	11	22		dB
Input Power for 1 dB Compression ($V_{ctl} = 0/+5V$)	0.5 - 1.0 GHz	25	30		dBm
	0.5 - 3.0 GHz	23	29		dBm
Input Third Order Intercept ($V_{ctl} = 0/+5V$) (Two-tone Input Power = +9 dBm Each Tone)	0.5 - 1.0 GHz	40	55		dBm
	0.5 - 3.0 GHz	38	54		dBm
Switching Characteristics	DC - 3.0 GHz				
	tRISE, tFALL (10/90% RF)		3		ns
	tON, tOFF (50% CTL to 10/90% RF)		10		ns



Insertion Loss

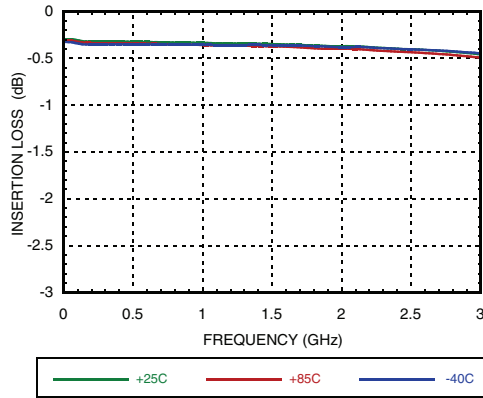

Isolation

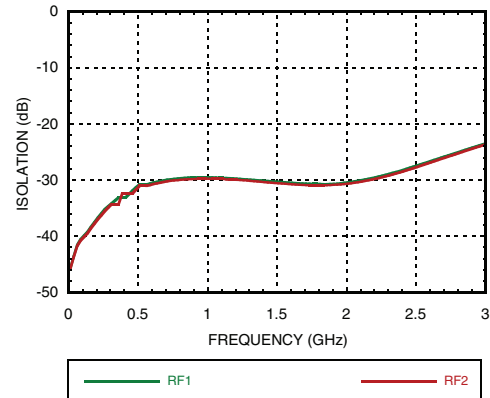

Return Loss

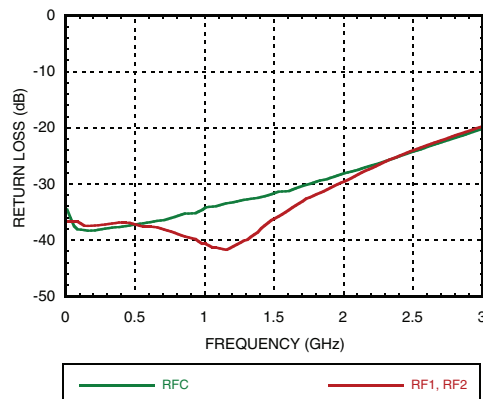

Input 0.1 and 1.0 dB Compression vs. Control Voltage

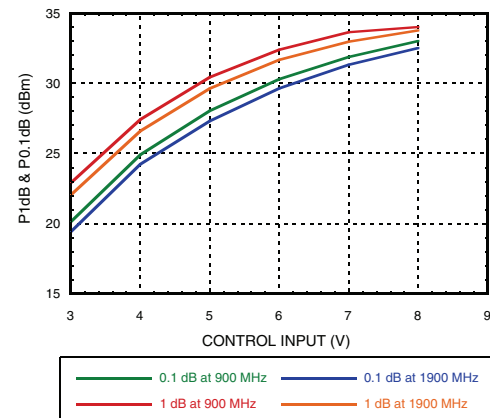

Input Third Order Intercept Point vs. Control Voltage

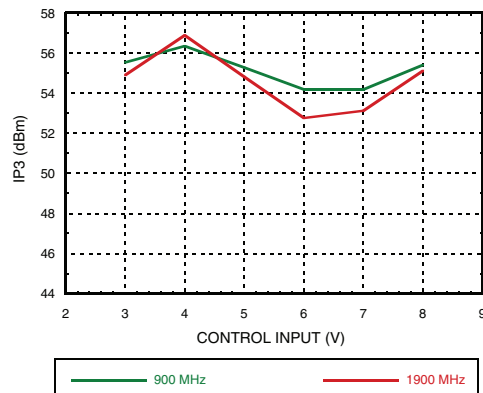

Distortion vs. Control Voltage

Control Input (Vdc)	Third Order Intercept (dBm) +9 dBm Each Tone	
	900 MHz	1900 MHz
+3	55	55
+5	55	55
+8	55	55

Truth Table

*Control Input Voltage Tolerances are ± 0.2 Vdc.

Control Input*		Control Current		Signal Path State	
A (Vdc)	B (Vdc)	Ia (µA)	Ib (µA)	RF to RF1	RF to RF2
0	+3	-0.1	0.1	ON	OFF
+3	0	0.1	-0.1	OFF	ON
0	+5	-1	1	ON	OFF
+5	0	1	-1	OFF	ON
0	+8	-5	5	ON	OFF
+8	0	5	-5	OFF	ON

Compression vs. Control Voltage

Control Input (Vdc)	Carrier at 900 MHz		Carrier at 1900 MHz	
	Input Power for 0.1 dB Compression (dBm)	Input Power for 1 dB Compression (dBm)	Input Power for 0.1 dB Compression (dBm)	Input Power for 1.0 dB Compression (dBm)
+3	20	23	20	22
+5	28	30	27	30
+8	32	34	31	33

Caution: Do not operate in 1dB compression at power levels above +31 dBm (Vctl = +5 Vdc) and do not "hot switch" power levels greater than +20 dBm (Vctl = +5 Vdc). DC blocks are required at ports RFC, RF1 and RF2.

Absolute Maximum Ratings

Control Voltage Range (A & B)	-0.2 to 12 Vdc
Channel Temperature	150 °C
Continuous P _{diss} (T = 85 °C) (derate 5.6 mW/°C above 85 °C)	0.36 W
Thermal Resistance	178 °C/W
Storage Temperature	-65 to +150 °C
Operating Temperature	-40 to +105 °C
ESD Sensitivity (HBM)	Class 1A

Outline Drawing

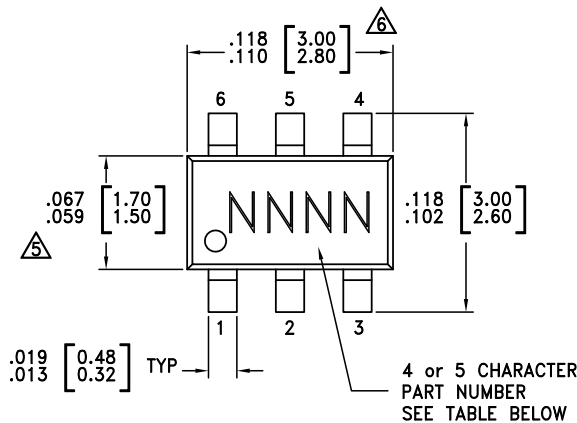

ELECTROSTATIC SENSITIVE DEVICE
OBSERVE HANDLING PRECAUTIONS

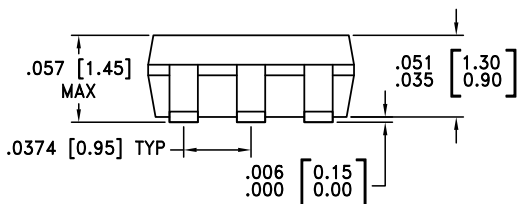
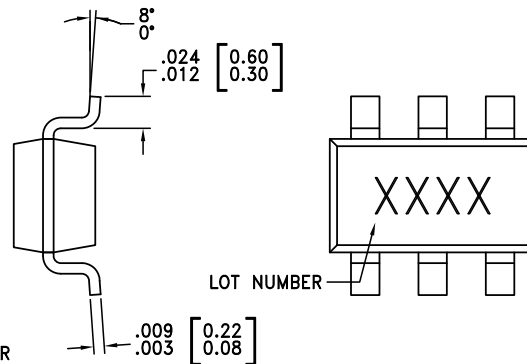

NOTES:

- LEADFRAME MATERIAL: COPPER ALLOY
- DIMENSIONS ARE IN INCHES [MILLIMETERS].
- DIMENSION DOES NOT INCLUDE MOLDFLASH OF 0.15mm PER SIDE.
- DIMENSION DOES NOT INCLUDE MOLDFLASH OF 0.25mm PER SIDE.
- ALL GROUND LEADS MUST BE SOLDERED TO PCB RF GROUND.

Package Information

Part Number	Package Body Material	Lead Finish	MSL Rating	Package Marking
HMC221B	Low Stress Injection Molded Plastic	Sn/Pb Solder	MSL1 [1]	221B XXXX
HMC221BE	RoHS-compliant Low Stress Injection Molded Plastic	100% matte Sn	MSL1 [2]	221BE XXXX

[1] Max peak reflow temperature of 235 °C

[2] Max peak reflow temperature of 260 °C

Typical Application Circuit

Notes:

1. Set logic gate and switch Vdd = +3V to +5V and use HCT series logic to provide a TTL driver interface.
2. Control inputs A/B can be driven directly with CMOS logic (HC) with Vdd of 5 to 8 Volts applied to the CMOS logic gates.
3. DC Blocking capacitors are required for each RF port as shown. Capacitor value determines lowest frequency of operation.
4. Highest RF signal power capability is achieved with Vdd = +8V and A/B set to 0/+8V.

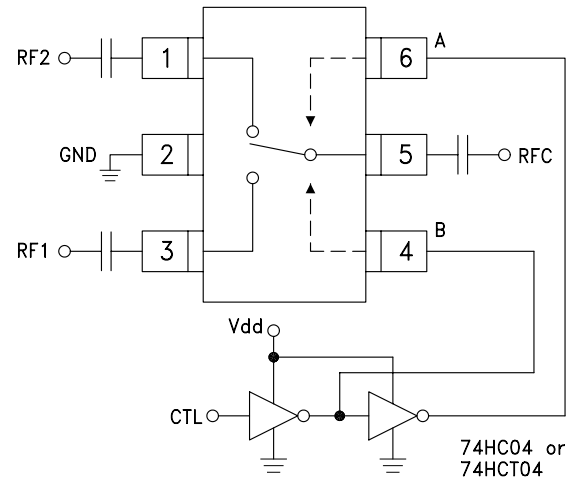

Evaluation Circuit Board

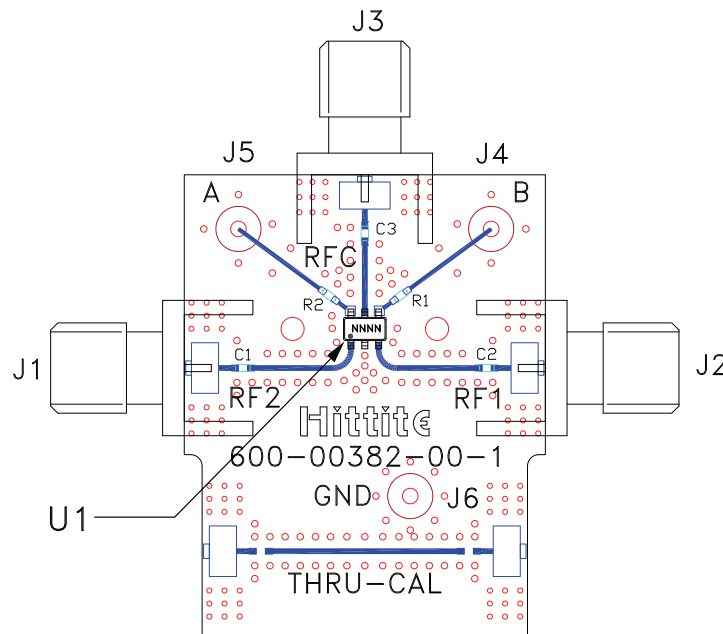

List of Materials for Evaluation PCB EVAL01 - HMC221B [1]

Item	Description
J1 - J3	PCB Mount SMA RF Connector
J4 - J6	DC Pin
C1 - C3	330 pF Capacitor, 0402 Pkg.
R1, R2	1 kOhm Resistor, 0402 Pkg.
U1	HMC221B / 221BE SPDT Switch
PCB [2]	600-00382-00-1 Evaluation PCB

[1] Reference this number when ordering complete evaluation PCB

[2] Circuit Board Material: Rogers 4350

The circuit board used in the application should be generated with proper RF circuit design techniques. Signal lines at the RF port should have 50 Ohm impedance and the package ground leads and package bottom should be connected directly to the ground plane similar to that shown above. The evaluation circuit board shown above is available from Hittite Microwave Corporation upon request.



Компания «ЭлектроПласт» предлагает заключение долгосрочных отношений при поставках импортных электронных компонентов на взаимовыгодных условиях!

Наши преимущества:

- Оперативные поставки широкого спектра электронных компонентов отечественного и импортного производства напрямую от производителей и с крупнейших мировых складов;
- Поставка более 17-ти миллионов наименований электронных компонентов;
- Поставка сложных, дефицитных, либо снятых с производства позиций;
- Оперативные сроки поставки под заказ (от 5 рабочих дней);
- Экспресс доставка в любую точку России;
- Техническая поддержка проекта, помощь в подборе аналогов, поставка прототипов;
- Система менеджмента качества сертифицирована по Международному стандарту ISO 9001;
- Лицензия ФСБ на осуществление работ с использованием сведений, составляющих государственную тайну;
- Поставка специализированных компонентов (Xilinx, Altera, Analog Devices, Intersil, Interpoint, Microsemi, Aeroflex, Peregrine, Syfer, Eurofarad, Texas Instrument, Miteq, Cobham, E2V, MA-COM, Hittite, Mini-Circuits, General Dynamics и др.);

Помимо этого, одним из направлений компании «ЭлектроПласт» является направление «Источники питания». Мы предлагаем Вам помощь Конструкторского отдела:

- Подбор оптимального решения, техническое обоснование при выборе компонента;
- Подбор аналогов;
- Консультации по применению компонента;
- Поставка образцов и прототипов;
- Техническая поддержка проекта;
- Защита от снятия компонента с производства.



Как с нами связаться

Телефон: 8 (812) 309 58 32 (многоканальный)

Факс: 8 (812) 320-02-42

Электронная почта: org@eplast1.ru

Адрес: 198099, г. Санкт-Петербург, ул. Калинина, дом 2, корпус 4, литера А.