

1

MBZ1 Stößel

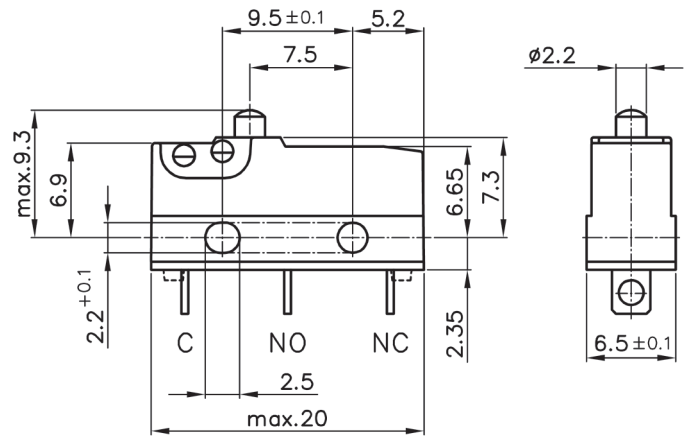

Zugfeder Kontaktsystem

- Microschalter Bauform B gem. DIN 41635
- funktionale Endkontrolle
- solide Konstruktion
- hochwertige Materialien
- sehr genaue Schaltlage
- Version 100mA 12VDC mit Goldkontakten
- Glühdrahtprüfung GWT750°C/2s nach DIN EN60335-1 (Hausgerätenorm) wird erfüllt

Microschalter, auch als Schnappschalter bezeichnet, werden vorrangig als Endschalter eingesetzt, sind aber auch für viele weitere Industrieanwendungen geeignet. Die Schaltgeschwindigkeit ist weitgehend unabhängig von der eigentlichen Betätigungsgeschwindigkeit. Die nach ISO 9001:2000 zertifizierte Fertigung und die 100% funktionale Endkontrolle garantieren die zuverlässige Funktion. Bei diesen Schaltern haben wir unsere langjährige Erfahrung und Zuverlässigkeit im Schalterbau eingebracht.

Tension spring mechanism

- Micro switches design B acc. to DIN 41635
- functional final inspection and testing
- solid design
- high-quality materials
- very exact switching position
- Version 100 mA 12VDC with Au plated contacts
- Fulfills glow wire testing GWT 750°C acc. DIN EN 60335-1 (household appliance standard)

Micro switches, also known as snap action switches, are primarily used as limit switches, but are also suitable for many other industry applications. The actual switching speed is completely independent from the speed of operation. ISO 9001:2000 approved production together with 100% functional final inspection and testing guarantee reliable operation. These products reflect our long standing experience in design and production of high quality switches.

MECHANISCHE KENNWERTE

MECHANISCHE KENNWERTE	MECHANICAL DATA	
Mech. Lebensdauer	Mech. lifetime	10 000 000 Schaltungen / 10 000 000 actuations
Elektr. Lebensdauer	Electrical lifetime	min. 10 000 Schaltungen / min. 10 000 actuations
abhängig von Schaltleistung	depending on switching capacity	
Differenzweg	Movement differential	≤ 0,13mm
Vorlaufweg	Pretravel	≤ 1mm
Nachlaufweg	Overtravel	0,3 - 0,6mm
Schaltpunkt	Operating position	8,4 ± 0,3mm
Kontaktöffnungsweite	Contact opening	<3mm (μ)

SONSTIGE KENNWERTE

SONSTIGE KENNWERTE	OTHER DATA	
Zulassungen	Approvals	ENEC-VDE, cULus, cCSAus

MATERIAL

MATERIAL	MATERIAL	
Socket	Base	PBT (UL94-V0)
Kappe	Cap	PBT (UL94-V0)
Betätiger bis 85°C Umgebungstemperatur	Actuator for 85°C ambient temperature	POM (UL94-HB)
Betätiger bis 130°C Umgebungstemperatur	Actuator for 130°C ambient temperature	PBT (UL94-V0)
Anschlüsse	Terminals	CuZn versilbert / CuZn Ag plated
Kontakte	Contacts	AgNi, AgNi vergoldet / AgNi, AgNi Au plated
Kontaktgeber	Contact spring	CuBe

MBZ1 Plunger

2 SCHALTLEISTUNG / RATING

10(1,5)A 250VAC	Code: MBZ1 01	3	4	5	6	7	8
6A 250VAC	Code: MBZ1 02	3	4	5	6	7	8
100mA 12VDC	Code: MBZ1 06	3	4	5	6	7	8

3 BETÄTIGUNGSKRAFT / OPERATING FORCE

2,8N	Code: MBZ1 2 A	4	5	6	7	8
1,5N	Code: MBZ1 2 B	4	5	6	7	8
0,6N	Code: MBZ1 2 C	4	5	6	7	8

EMPFOHLENE KOMBINATIONEN / RECOMMENDED COMBINATIONS

	2,8N	1,5N	0,6N
10(1,5)A 250VAC	■	■	
6A 250VAC	■	■	
100mA 12VDC	■	■	■

4 UMGEBUNGSTEMPERATUR / AMBIENT TEMPERATURE

-40...+85°C	Code: MBZ1 2 3 01	5	6	7	8
-40...+130°C	Code: MBZ1 2 3 02	5	6	7	8

5 KONTAKTANORDNUNG / CONTACT ARRANGEMENT

Öffner / Normally closed Code: MBZ1 2 3 4 A 6 7 8	Schließer / Normally open Code: MBZ1 2 3 4 B 6 7 8	Wechsler / Change-over Code: MBZ1 2 3 4 C 6 7 8
--	---	--

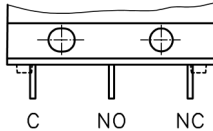
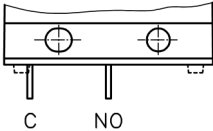
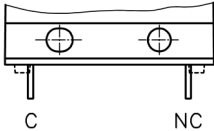

MBZ1 Stößel

6 BETÄTIGER / ACTUATOR

Stößel Radius / Plunger with radius

Code: MBZ1 2 3 4 5 01 7 8

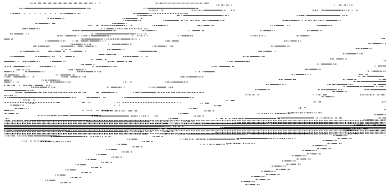

Stößel Kugelform / Plunger sperical form

Code: MBZ1 2 3 4 5 02 7 8



7 EINHÄNGEPUNKT / FIXING POSITION

Kein Zusatzbetätiger / No additional actuator

Code: MBZ1 2 3 4 5 6 X 8

8 ANSCHLÜSSE / TERMINALS

Flachlötanschluss / Solder terminal

Code: MBZ1 2 3 4 5 6 7 01

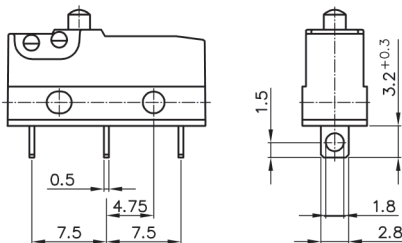

LP-Anschluss 0,5x1,3mm / PCB terminal

Code: MBZ1 2 3 4 5 6 7 02

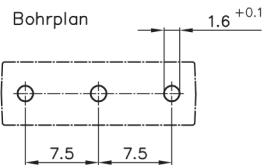
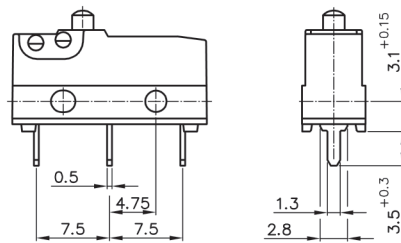

LP-Anschluss 0,5x0,6mm / PCB terminal

Code: MBZ1 2 3 4 5 6 7 03

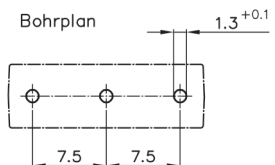
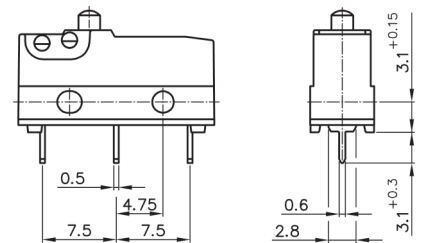

MBZ1 Plunger

ÜBERSICHT BETÄTIGER / WEGE / KRÄFTE
 OVERVIEW ACTUATORS / TRAVEL / FORCES

	Code	mm	≤ N	Code	≤ N	≤ mm	min. mm	≤ mm	≤ mm	mm
Stößel Radius	01	-	2,8	A	-	1,2	0,3 - 0,6	0,13	9,3	8,4 ±0,3
Plunger with radius			1,5	B						
			0,6	C						
	Code	mm	≤ N	Code	≤ N	≤ mm	min. mm	≤ mm	≤ mm	mm
Stößel Kugel	02	-	2,8	A	-	1,2	0,3 - 0,6	0,13	9,3	8,4 ±0,3
Plunger sperical form			1,5	B						
			0,6	C						

Zusatzbetätigerlänge
 Actuator length

Betätigungskraft am Stößel
 Operating force on plunger

Betätigungskraft am Zusatzbetätiger
 Operating force on lever

Vorlaufweg
 Pretravel

Nachlaufweg
 Overtravel

Differenzweg
 Movement differential

Ruhestellung
 Free position

Schaltpunkt
 Operating position

1

MBZ1 Hebel

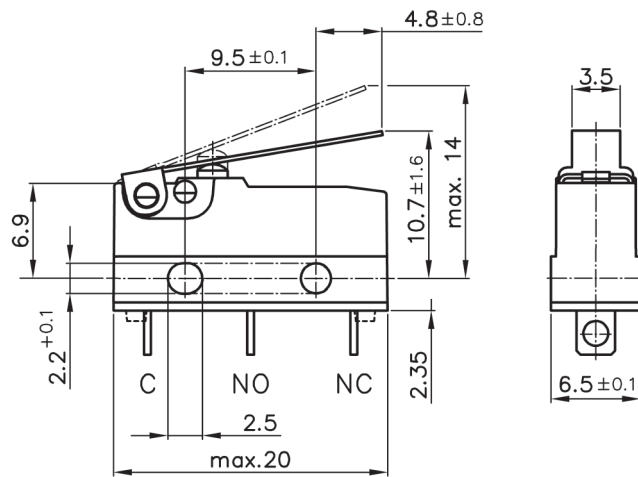

Zugfeder Kontaktsystem

- Microschalter Bauform B gem. DIN 41635
- funktionale Endkontrolle
- solide Konstruktion
- hochwertige Materialien
- sehr genaue Schaltlage
- Version 100mA 12VDC mit Goldkontakten
- Glühdrahtprüfung GWT750°C/2s nach DIN EN60335-1 (Hausgerätenorm) wird erfüllt

Microschalter, auch als Schnappschalter bezeichnet, werden vorrangig als Endschalter eingesetzt, sind aber auch für viele weitere Industrieanwendungen geeignet. Die Schaltgeschwindigkeit ist weitgehend unabhängig von der eigentlichen Betätigungsgeschwindigkeit. Die nach ISO 9001:2000 zertifizierte Fertigung und die 100% funktionale Endkontrolle garantieren die zuverlässige Funktion. Bei diesen Schaltern haben wir unsere langjährige Erfahrung und Zuverlässigkeit im Schalterbau eingebracht.

Tension spring mechanism

- Micro switches design B acc. to DIN 41635
- functional final inspection and testing
- solid design
- high-quality materials
- very exact switching position
- Version 100mA 12VDC with Au plated contacts
- Fulfills glow wire testing GWT 750°C acc. DIN EN 60335-1 (household appliance standard)

Micro switches, also known as snap action switches, are primarily used as limit switches, but are also suitable for many other industry applications. The actual switching speed is completely independent from the speed of operation. ISO 9001:2000 approved production together with 100% functional final inspection and testing guarantee reliable operation. These products reflect our long standing experience in design and production of high quality switches.

MECHANISCHE KENNWERTE

MECHANISCHE KENNWERTE	MECHANICAL DATA	
Mech. Lebensdauer	Mech. lifetime	10 000 000 Schaltungen / 10 000 000 actuations
Elektr. Lebensdauer	Electrical lifetime	min. 10 000 Schaltungen / min. 10 000 actuations
abhängig von Schaltleistung	depending on switching capacity	
Differenzweg	Movement differential	siehe Übersicht nächste Seite / please see overview next page
Vorlaufweg	Pretravel	siehe Übersicht nächste Seite / please see overview next page
Nachlaufweg	Overtravel	siehe Übersicht nächste Seite / please see overview next page
Schaltpunkt	Operating position	siehe Übersicht nächste Seite / please see overview next page
Kontaktöffnungsweite	Contact opening	<3mm (μ)

SONSTIGE KENNWERTE

SONSTIGE KENNWERTE	OTHER DATA	
Zulassungen	Approvals	ENEC-VDE, cULus, cCSAus

MATERIAL

MATERIAL	MATERIAL	
Socket	Base	PBT (UL94-V0)
Kappe	Cap	PBT (UL94-V0)
Betätiger bis 85°C Umgebungstemperatur	Actuator for 85°C ambient temperature	POM (UL94-HB) / POM (UL94-HB)
Betätiger bis 130°C Umgebungstemperatur	Actuator for 130°C ambient temperature	PBT (UL94-V0)
Anschlüsse	Terminals	CuZn versilbert / CuZn Ag plated
Kontakte	Contacts	AgNi, AgNi vergoldet / AgNi, AgNi Au plated
Kontaktgeber	Contact spring	CuBe

MBZ1 Hinge lever

2 SCHALTLEISTUNG / RATING

10(1,5)A 250VAC
6A 250VAC
100mA 12VDC

Code: MBZ1 01 3 4 5 6 7 8
☎ Code: MBZ1 02 3 4 5 6 7 8
☎ Code: MBZ1 06 3 4 5 6 7 8

3 BETÄTIGUNGSKRAFT / OPERATING FORCE

2,8N
1,5N
0,6N

Code: MBZ1 2 A 4 5 6 7 8
☎ Code: MBZ1 2 B 4 5 6 7 8
☎ Code: MBZ1 2 C 4 5 6 7 8

EMPFOHLENE KOMBINATIONEN / RECOMMENDED COMBINATIONS

	2,8N	1,5N	0,6N
10(1,5)A 250VAC	■	■	
6A 250VAC	■	■	
100mA 12VDC	■	■	■

4 UMGEBUNGSTEMPERATUR / AMBIENT TEMPERATURE

-40...+85°C
-40...+130°C

Code: MBZ1 2 3 01 5 6 7 8
☎ Code: MBZ1 2 3 02 5 6 7 8

5 KONTAKTANORDNUNG / CONTACT ARRANGEMENT

Öffner / Normally closed

Code: MBZ1 2 3 4 A 6 7 8

Schließer / Normally open

Code: MBZ1 2 3 4 B 6 7 8

Wechsler / Change-over

Code: MBZ1 2 3 4 C 6 7 8

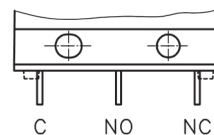
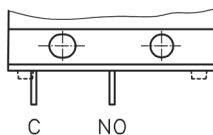
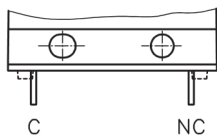

MBZ1 Hebel

6 BETÄTIGER / ACTUATOR

Hebel kurz / Hinge lever short

Code: MBZ1 2 3 4 5 **03** 7 8

Hebel lang / Hinge lever long

Code: MBZ1 2 3 4 5 **04** 7 8

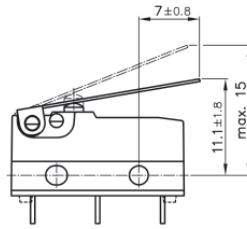
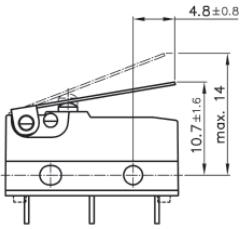

7 EINHÄNGEPUNKT / FIXING POSITION

vorne / front

Code: MBZ1 2 3 4 5 6 **A** 8

hinten / rear

Code: MBZ1 2 3 4 5 6 **B** 8

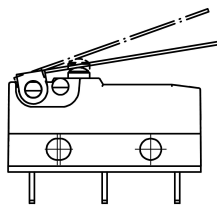
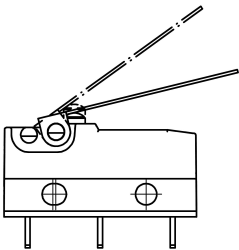

8 ANSCHLÜSSE / TERMINALS

Flachlötanschluss / Solder terminal

Code: MBZ1 2 3 4 5 6 7 **01**

LP-Anschluss 0,5x1,3mm / PCB terminal

Code: MBZ1 2 3 4 5 6 7 **02**

LP-Anschluss 0,5x0,6mm / PCB terminal

 Code: MBZ1 2 3 4 5 6 7 **03**

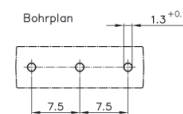
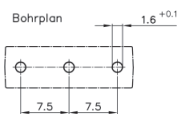
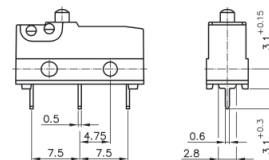
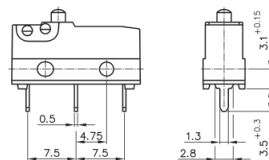
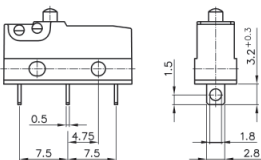

MBZ1 Hinge lever

ÜBERSICHT BETÄTIGER / WEGE / KRÄFTE
OVERVIEW ACTUATORS / TRAVEL / FORCES

		Zusatzbetätigerlänge Actuator length	Betätigungskraft am Stoßel Operating force on plunger	Betätigungskraft am Zusatzbetätiger Operating force on lever	Vorlaufweg Pretravel	Nachlaufweg Overtravel	Differenzweg Movement differential	Ruhestellung Free position	Schaltpunkt Operating position	
Einhängepunkt vorne / Fixing position front										
	Code	mm	≤ N	Code	≤ N	≤ mm	min. mm	≤ mm	≤ mm	mm
Hebel kurz	03	7,0	2,8	A	0,45	9	1,25 - 2,5	1,5	18	12 ±3
Hinge lever short			1,5	B	0,24					
			0,6	C	0,10					
	Code	mm	≤ N	Code	≤ N	≤ mm	min. mm	≤ mm	≤ mm	mm
Hebel lang	04	9,4	2,8	A	0,40	10	1,5 - 3	1,8	20	12,5 ±3,5
Hinge lever long			1,5	B	0,21					
			0,6	C	0,09					
Einhängepunkt hinten / Fixing position rear										
	Code	mm	≤ N	Code	≤ N	≤ mm	min. mm	≤ mm	≤ mm	mm
Hebel kurz	03	4,8	2,8	A	1,00	4,5	0,75 - 1,5	0,9	14	10,7 ±1,6
Hinge lever short			1,5	B	0,54					
			0,6	C	0,21					
	Code	mm	≤ N	Code	≤ N	≤ mm	min. mm	≤ mm	≤ mm	mm
Hebel lang	04	7,0	2,8	A	0,85	5	0,75 - 1,5	1,2	15	11,1 ±1,8
Hinge lever long			1,5	B	0,46					
			0,6	C	0,18					

1

MBZ1 Rolle

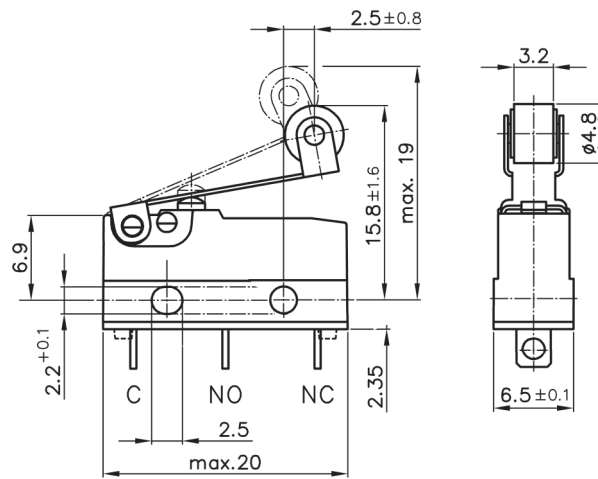

Zugfeder Kontaktsystem

- Microschalter Bauform B gem. DIN 41635
- funktionale Endkontrolle
- solide Konstruktion
- hochwertige Materialien
- sehr genaue Schaltlage
- Version 100mA 12VDC mit Goldkontakten auf Anfrage
- Glühdrahtprüfung GWT750°C/2s nach DIN EN60335-1 (Hausgerätenorm) wird erfüllt

Microschalter, auch als Schnappschalter bezeichnet, werden vorrangig als Endschalter eingesetzt, sind aber auch für viele weitere Industrieanwendungen geeignet. Die Schaltgeschwindigkeit ist weitgehend unabhängig von der eigentlichen Betätigungsgeschwindigkeit. Die nach ISO 9001:2000 zertifizierte Fertigung und die 100% funktionale Endkontrolle garantieren die zuverlässige Funktion. Bei diesen Schaltern haben wir unsere langjährige Erfahrung und Zuverlässigkeit im Schalterbau eingebracht.

Tension spring mechanism

- Micro switches design B acc. to DIN 41635
- functional final inspection and testing
- solid design
- high-quality materials
- very exact switching position
- Version 100mA 12VDC with Au plated contacts on request
- Fulfills glow wire testing GWT 750°C acc. DIN EN 60335-1 (household appliance standard)

Micro switches, also known as snap action switches, are primarily used as limit switches, but are also suitable for many other industry applications. The actual switching speed is completely independent from the speed of operation. ISO 9001:2000 approved production together with 100% functional final inspection and testing guarantee reliable operation. These products reflect our long standing experience in design and production of high quality switches.

MECHANISCHE KENNWERTE

Mech. Lebensdauer	Mech. lifetime
Elektr. Lebensdauer	Electrical lifetime
abhängig von Schaltleistung	depending on switching capacity
Differenzweg	Movement differential
Vorlaufweg	Pretravel
Nachlaufweg	Overtravel
Schaltpunkt	Operating position
Kontaktöffnungsweite	Contact opening

MECHANICAL DATA

10 000 000 Schaltungen / 10 000 000 actuations
min. 10 000 Schaltungen / min. 10 000 actuations
siehe Übersicht nächste Seite / please see overview next page
siehe Übersicht nächste Seite / please see overview next page
siehe Übersicht nächste Seite / please see overview next page
siehe Übersicht nächste Seite / please see overview next page
<3mm (µ)

SONSTIGE KENNWERTE

Zulassungen

OTHER DATA

Approvals

ENEC-VDE, cULus, cCSAus

MATERIAL



Socket
Kappe
Betätiger bis 85°C Umgebungstemperatur
Betätiger bis 130°C Umgebungstemperatur
Anschlüsse
Kontakte
Kontaktgeber

MATERIAL

Base	PBT (UL94-V0)
Cap	PBT (UL94-V0)
Actuator for 85°C ambient temperature	POM (UL94-HB) / POM (UL94-HB)
Actuator for 130°C ambient temperature	PBT (UL94-V0)
Terminals	CuZn versilbert / CuZn Ag plated
Contacts	AgNi, AgNi vergoldet / AgNi, AgNi Au plated
Contact spring	CuBe

MBZ1 Roller lever

2 SCHALTLEISTUNG / RATING

10(1,5)A 250VAC									Code: MBZ1 01	3	4	5	6	7	8
6A 250VAC									 Code: MBZ1 02	3	4	5	6	7	8
100mA 12VDC									 Code: MBZ1 06	3	4	5	6	7	8

3 BETÄTIGUNGSKRAFT / OPERATING FORCE

2,8N										Code: MBZ1 2 A	4	5	6	7	8
1,5N									 Code: MBZ1 2 B	4	5	6	7	8	
0,6N									 Code: MBZ1 2 C	4	5	6	7	8	

EMPFOLHENE KOMBINATIONEN / RECOMMENDED COMBINATIONS

	2,8N	1,5N	0,6N
10(1,5)A 250VAC	■	■	
6A 250VAC	■	■	
100mA 12VDC	■	■	■

4 UMGEBUNGSTEMPERATUR / AMBIENT TEMPERATURE

-40...+85°C										Code: MBZ1 2 3 01	5	6	7	8
-40...+130°C									 Code: MBZ1 2 3 02	5	6	7	8	

5 KONTAKTANORDNUNG / CONTACT ARRANGEMENT

Öffner / Normally closed Code: MBZ1 2 3 4 A 6 7 8	Schließer / Normally open Code: MBZ1 2 3 4 B 6 7 8	Wechsler / Change-over Code: MBZ1 2 3 4 C 6 7 8
---	--	---

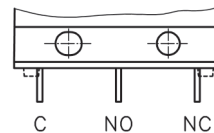
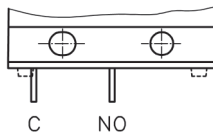
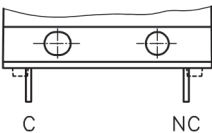

MBZ1 Rolle

6 BETÄTIGER / ACTUATOR

Rolle kurz / Roller lever short

Code: MBZ1 2 3 4 5 **05** 7 8

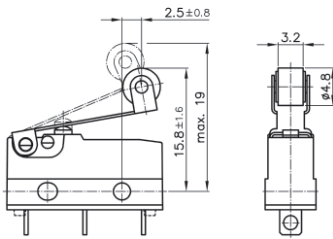

Rolle lang / Roller lever long

Code: MBZ1 2 3 4 5 **06** 7 8

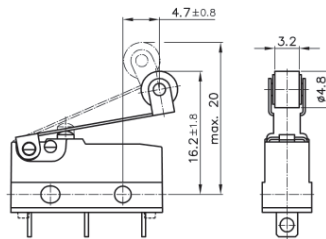

Simulierte Rolle kurz / Simulated roller lever short

Code: MBZ1 2 3 4 5 **07** 7 8

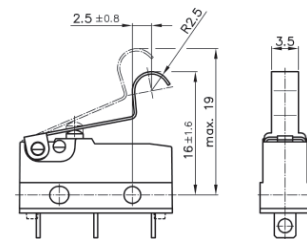

Simulierte Rolle lang / Simulated roller lever long

Code: MBZ1 2 3 4 5 **08** 7 8

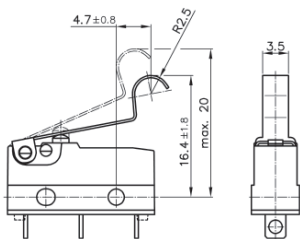

7 EINHÄNGEPUNKT / FIXING POSITION

vorne / front

Code: MBZ1 2 3 4 5 6 **A** 8

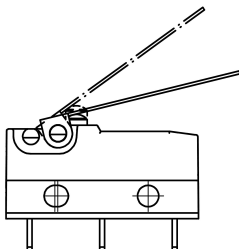

hinten / rear

Code: MBZ1 2 3 4 5 6 **B** 8

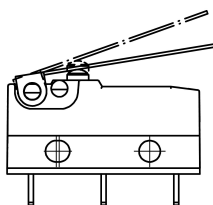

8 ANSCHLÜSSE / TERMINALS

Flachlötanschluss / Solder terminal

Code: MBZ1 2 3 4 5 6 7 **01**

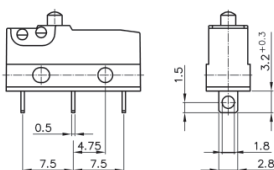

LP-Anschluss 0,5x1,3mm / PCB terminal

Code: MBZ1 2 3 4 5 6 7 **02**

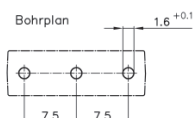
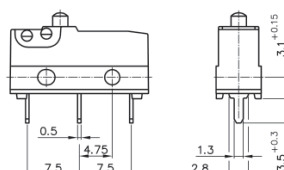

LP-Anschluss 0,5x0,6mm / PCB terminal

Code: MBZ1 2 3 4 5 6 7 **03**

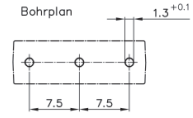
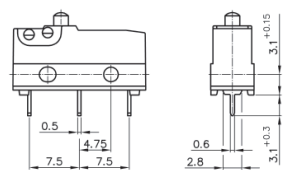

MBZ1 Roller lever

ÜBERSICHT BETÄTIGER / WEGE / KRÄFTE
OVERVIEW ACTUATORS / TRAVEL / FORCES

		Zusatzbetätigerlänge Actuator length	Betätigungskraft am Stößel Operating force on plunger	Betätigungskraft am Zusatzbetätiger Operating force on lever	Vorlaufweg Pretravel	Nachlaufweg Overtravel	Differenzweg Movement differential	Ruhestellung Free position	Schaltpunkt Operating position	
Einhängepunkt vorne / Fixing position front										
	Code	mm	≤ N	Code	≤ N	≤ mm	min. mm	≤ mm	≤ mm	mm
Rolle kurz Roller lever short	05	4,7	2,8	A	0,50	9	1,25 - 2,5	1,5	22	17 ±3
			1,5	B	0,27					
			0,6	C	0,11					
	Code	mm	≤ N	Code	≤ N	≤ mm	min. mm	≤ mm	≤ mm	mm
Rolle lang Roller lever long	06	7,1	2,8	A	0,40	10	1,5 - 3	1,8	24	17,5 ±3,5
			1,5	B	0,21					
			0,6	C	0,09					
	Code	mm	≤ N	Code	≤ N	≤ mm	min. mm	≤ mm	≤ mm	mm
Simulierte Rolle kurz Simulated roller lever short	07	4,7	2,8	A	0,60	9	1,25 - 2,5	1,5	22	17,2 ±3
			1,5	B	0,32					
			0,6	C	0,13					
	Code	mm	≤ N	Code	≤ N	≤ mm	min. mm	≤ mm	≤ mm	mm
Simulierte Rolle lang Simulated roller lever long	08	7,1	2,8	A	0,50	10	1,5 - 3	1,8	24	17,7 ±3,5
			1,5	B	0,27					
			0,6	C	0,11					
Einhängepunkt hinten / Fixing position rear										
	Code	mm	≤ N	Code	≤ N	≤ mm	min. mm	≤ mm	≤ mm	mm
Rolle kurz Roller lever short	05	2,5	2,8	A	1,10	4,5	0,75 - 1,5	0,7	19	15,8 ±1,6
			1,5	B	0,59					
			0,6	C	0,24					
	Code	mm	≤ N	Code	≤ N	≤ mm	min. mm	≤ mm	≤ mm	mm
Rolle lang Roller lever long	06	4,7	2,8	A	0,95	5	0,75 - 1,5	1	20	16,2 ±1,8
			1,5	B	0,51					
			0,6	C	0,20					
	Code	mm	≤ N	Code	≤ N	≤ mm	min. mm	≤ mm	≤ mm	mm
Simulierte Rolle kurz Simulated roller lever short	07	2,5	2,8	A	1,15	4,5	0,75 - 1,5	0,7	19,0	16 ±1,6
			1,5	B	0,62					
			0,6	C	0,25					
	Code	mm	≤ N	Code	≤ N	≤ mm	min. mm	≤ mm	≤ mm	mm
Simulierte Rolle lang Simulated roller lever long	08	4,7	2,8	A	0,95	5,0	0,75 - 1,5	1	20	16,4 ±1,8
			1,5	B	0,51					
			0,6	C	0,20					



Компания «ЭлектроПласт» предлагает заключение долгосрочных отношений при поставках импортных электронных компонентов на взаимовыгодных условиях!

Наши преимущества:

- Оперативные поставки широкого спектра электронных компонентов отечественного и импортного производства напрямую от производителей и с крупнейших мировых складов;
- Поставка более 17-ти миллионов наименований электронных компонентов;
- Поставка сложных, дефицитных, либо снятых с производства позиций;
- Оперативные сроки поставки под заказ (от 5 рабочих дней);
- Экспресс доставка в любую точку России;
- Техническая поддержка проекта, помощь в подборе аналогов, поставка прототипов;
- Система менеджмента качества сертифицирована по Международному стандарту ISO 9001;
- Лицензия ФСБ на осуществление работ с использованием сведений, составляющих государственную тайну;
- Поставка специализированных компонентов (Xilinx, Altera, Analog Devices, Intersil, Interpoint, Microsemi, Aeroflex, Peregrine, Syfer, Eurofarad, Texas Instrument, Miteq, Cobham, E2V, MA-COM, Hittite, Mini-Circuits, General Dynamics и др.);

Помимо этого, одним из направлений компании «ЭлектроПласт» является направление «Источники питания». Мы предлагаем Вам помощь Конструкторского отдела:

- Подбор оптимального решения, техническое обоснование при выборе компонента;
- Подбор аналогов;
- Консультации по применению компонента;
- Поставка образцов и прототипов;
- Техническая поддержка проекта;
- Защита от снятия компонента с производства.



Как с нами связаться

Телефон: 8 (812) 309 58 32 (многоканальный)

Факс: 8 (812) 320-02-42

Электронная почта: org@eplast1.ru

Адрес: 198099, г. Санкт-Петербург, ул. Калинина, дом 2, корпус 4, литера А.