

10069525 -

NUMBER OF POSITIONS	
04	2 X20
06	2 X30
08	2 X40
10	2 X50
12	2 X60
14	2 X70
16	2 X80
18	2 X90
20	2 X100

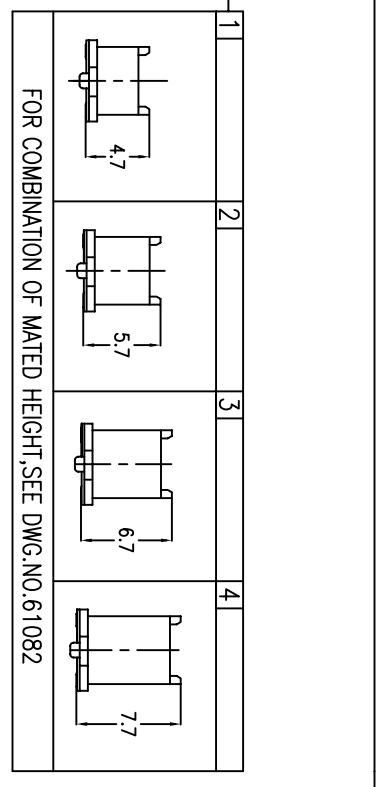

PACKAGING	
0	TUBE WITHOUT CAP
2	TAPE & REEL WITH CAP
9	TUBE WITH CAP

POLARIZATION PEG		HOLD DOWN	
0	YES		NO
2	NO		NO

PLATING ON CONTACT AREA.		EMPTY	
0	GOLD 0.2 um MIN. / TIN LEAD SOLDER		
1	PALLADIUM-NICKEL 0.76 umMIN. WITH GOLD FLASH (0.1 um MIN.) / TIN LEAD SOLDER		EMPTY
4	GOLD 0.2 um MIN. / MATT PURE TIN ON SOLDER TAIL (LEAD FREE PLATING)		LF (note 6&8.)
5	GOLD 0.38 um / MATT PURE TIN ON SOLDER TAIL (LEAD FREE PLATING)		LF (note 6.)
6	PALLADIUM-NICKEL 0.76 umMIN. WITH GOLD FLASH (0.1 um MIN.) / MATT PURE TIN ON SOLDER TAIL (LEAD FREE PLATING)		LF (note 6&8.)

NOTES:
1. MATERIAL: HOUSING: G.F.LCP UL94V-0
TERMINAL: BRASS

- PLATING: AS TABLE SHOW.
- SEE GS-12-148 FOR PRODUCT SPECIFICATION.
- SEE GS-14-551 AND GS-14-816 FOR PACKAGING SPECIFICATION.
- PACKING OPTION 3: "CUSTOMER-SPECIFIC; LIMITED TO CERTAIN SIZES" PACKING OPTION 2: NOT ALL SIZES AVAILABLE; CHECK WITH FACTORY"
- THIS PRODUCT MEETS EUROPEAN UNION DIRECTIVES AND OTHER COUNTRY REGULATIONS AS DESCRIBED IN GS-22-008
- THE HOUSING WILL WITHSTAND EXPOSURE TO 260°C PEAK TEMPERATURE FOR 10 SECONDS IN A CONVECTION, INFRA-RED OR VAPOR PHASE REFLOW OVEN.
- PLATING OPTION '4' IS LEADFREE ALTERNATIVE FOR OPTION '0', AND OPTION '6' IS LEADFREE ALTERNATIVE FOR OPTION '1'.
- THIS PARTNUMBER IS ONLY CATER FOR SPECIAL CUSTOMER REQUIREMENTS OF COPLANARITY OF 0.1 FOR ALL POSITIONS.
- A Δ SYMBOL WILL BE NEXT TO ANY DIMENSION, VIEW, OR NOTE WHICH HAS BEEN MODIFIED WITH THE CURRENT DRAWING REVISION.

mat'l. code		surface		tolerance		projection		product family	
ltr	ecrn no	dr	date	ASMEY14.5	ASME Y14.5	MM	MM	title	sheet no
A	S06-0286	MCH	2006-08-25	angles	.XX±0.20			0.8mm BOARD TO BOARD	sheet 1 of 6
B	S06-0316	MCH	2006-08-25	°±2'	.XXX±0.15			PLUG ASS'y	A4
C	S09-0216	MCH	2009-06-26	°±2'	.XXX±0.10				
D	S10-0069	MCH	2010-03-26	dr	M.CHEONG	2006-08-25	scale 3:1		
				enjr	M.CHEONG	2006-08-25			
				chr	M.CHEONG	2010-03-26			
				pppd	JOEY NG	2010-03-26			
sheet	revision	D	B	B	B	B	B		
index	sheet	1	2	3	4	5	6		



PRODUCT NO.	NUMBER OF POSITIONS	DIMENSION		
		A	B	C
10059525-041***	2 X20	15.2	21.8	20.2
10059525-061***	2 X30	23.2	29.8	28.2
10059525-081***	2 X40	31.2	37.8	36.2
10059525-101***	2 X50	39.2	45.8	44.2
10059525-121***	2 X60	47.2	53.8	52.2
10059525-141***	2 X70	55.2	61.8	60.2
10059525-161***	2 X80	63.2	69.8	68.2
10059525-181***	2 X90	71.2	77.8	76.2
10059525-201***	2 X100	79.2	85.8	84.2

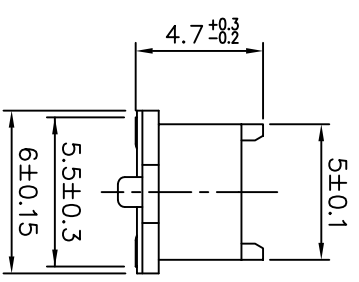
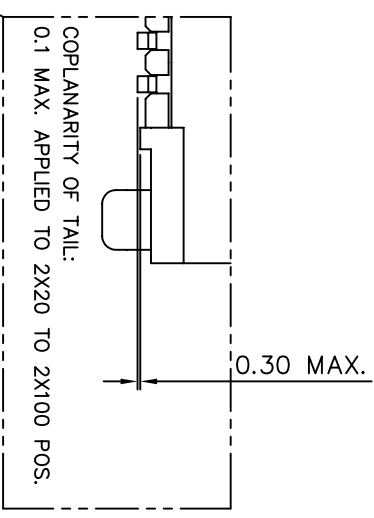
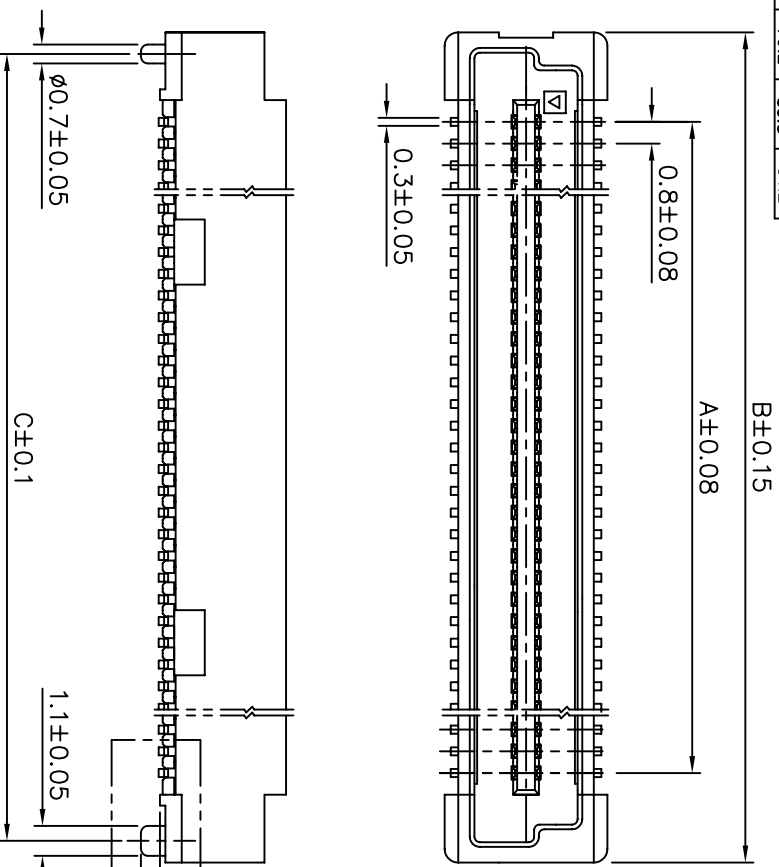

PLUG 1

form: AdmmXlc 1 2 3 4

B A

5

mat'l. code		surface		tolerance		projection		product family	
lfr	ecm no	dr	date	ASMEY14.5	ASME Y14.5	MM	FCI	BERGSTAK	title
A	S06-0286	MCH	2006-08-25	angles	.XX±0.20	MM	FCI	0.8mm BOARD TO BOARD	
B	S06-0316	MCH	2006-08-25	0±.2	.XXX±0.10	scale 3:1	FCI	PLUG ASS'y	
				dr	M.CHEONG	2006-08-25			
				enjr	M.CHEONG	2006-08-25			
				chr	M.CHEONG	2006-08-25			
				appd	JOEY NG	2006-08-25			
Sheet	revision								dwg no
Index	sheet								10069525
									sheet 2 of 6
									A4
									CUSTOMER Drawing



PRODUCT NO.	NUMBER OF POSITIONS	DIMENSION		
		A	B	C
10069525-042***	2 X20	15.2	21.8	20.2
10069525-062***	2 X30	23.2	29.8	28.2
10069525-082***	2 X40	31.2	37.8	36.2
10069525-102***	2 X50	39.2	45.8	44.2
10069525-122***	2 X60	47.2	53.8	52.2
10069525-142***	2 X70	55.2	61.8	60.2
10069525-162***	2 X80	63.2	69.8	68.2
10069525-182***	2 X90	71.2	77.8	76.2
10069525-202***	2 X100	79.2	85.8	84.2

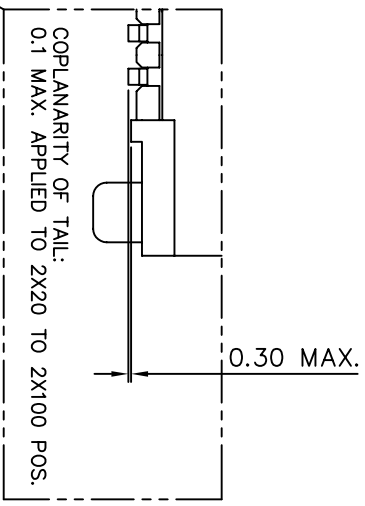
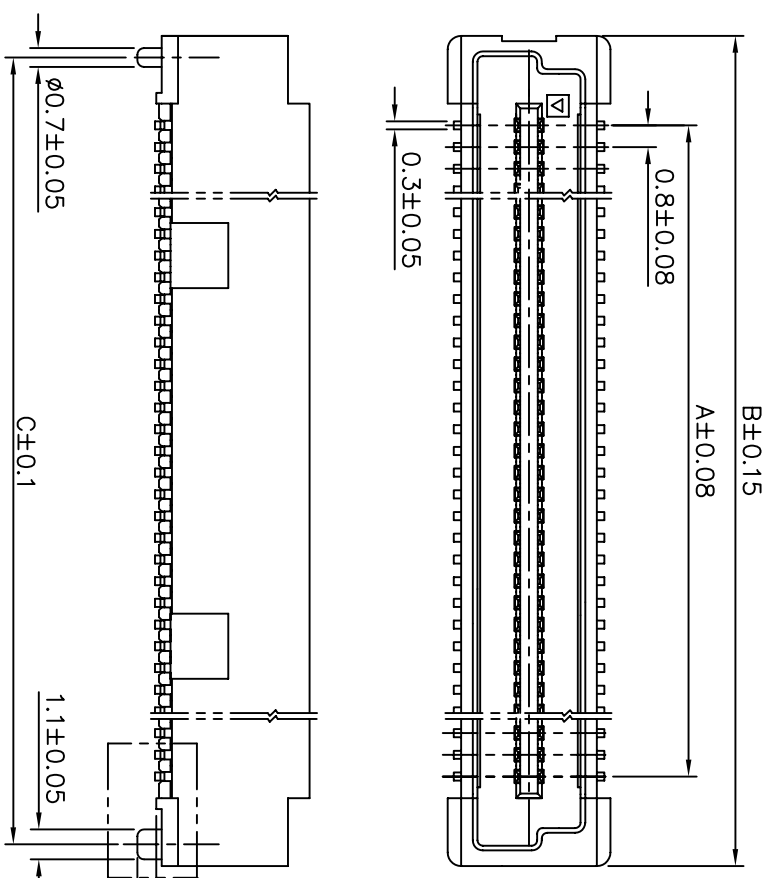

PLUG 2

mat'l. code		surface		tolerance		projection		product family	
ltr	ecrn no	dr	date	ASMEY14.5	ASME Y14.5	MM	FCI	BERGSTAK	title
A	S06-0286	MCH	2006-08-25	angles	.XX±0.20	MM	FCI	0.8mm BOARD TO BOARD	
B	S06-0316	MCH	2006-08-25	0±.2	.XXX±0.15	scale 3:1		PLUG ASS'Y	
				dr	M.CHEONG	2006-08-25			
				enpr	M.CHEONG	2006-08-25			
				chr	M.CHEONG	2006-08-25			
				appd	JOEY NG	2006-08-25			
sheet	revision								dwg no
index	sheet								10069525
									sheet 3 of 6
									A4
									CUSTOMER Drawing



PRODUCT NO.	NUMBER OF POSITIONS	DIMENSION		
		A	B	C
10069525-043***	2 X20	15.2	21.8	20.2
10069525-063***	2 X30	23.2	29.8	28.2
10069525-083***	2 X40	31.2	37.8	36.2
10069525-103***	2 X50	39.2	45.8	44.2
10069525-123***	2 X60	47.2	53.8	52.2
10069625-143***	2 X70	55.2	61.8	60.2
10069525-163***	2 X80	63.2	69.8	68.2
10069525-183***	2 X90	71.2	77.8	76.2
10069525-203***	2 X100	79.2	85.8	84.2

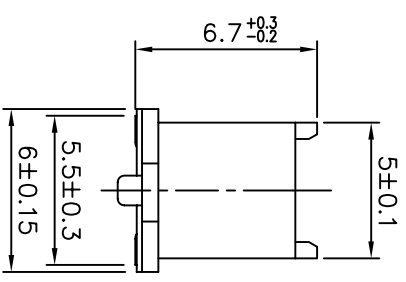
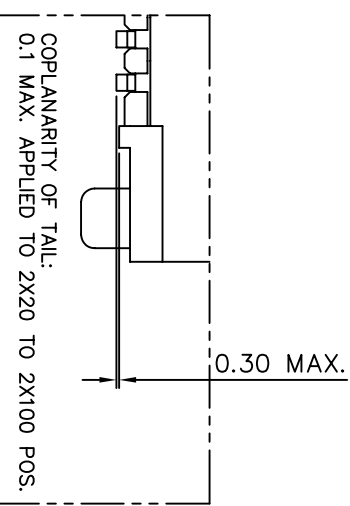
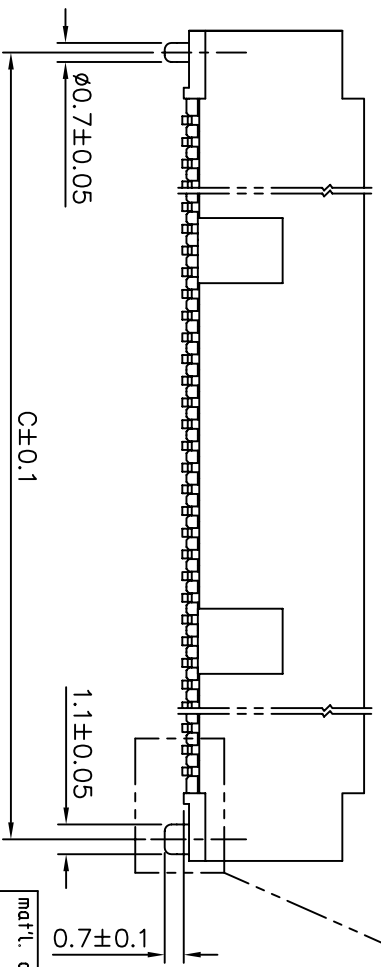
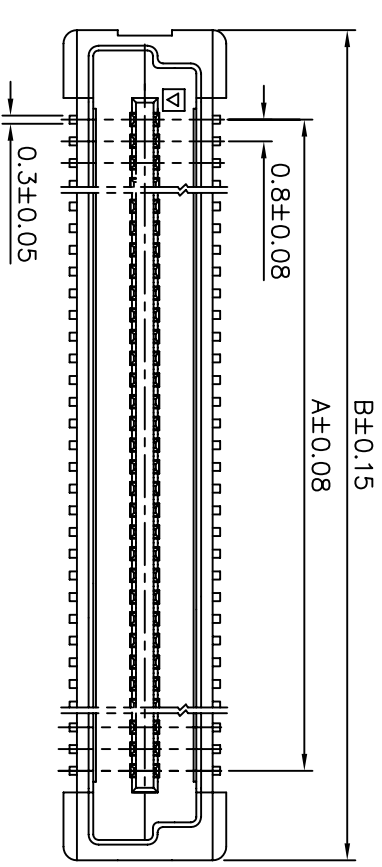

PLUG 3

ltr	ecrn no	dr	date	surface	tol	tol unless otherwise specified	projection	product family	title
A	S06-0286	MCH	2006-08-25	ASMEY14.5	ASME Y14.5		MM	BERGSTAK	0.8mm BOARD TO BOARD
B	S06-0316	MCH	2006-08-25				scale 3:1		PLUG ASS'y
mat'l. code		-		surface tolerance		ASMEY14.5 / ASME Y14.5		product family	
-		-		tol		tol unless otherwise specified		title	
-		-		angles		.XX±0.20		dwg no	
-		-		.XXX±0.15		scale 3:1		sheet 4 of 6	
-		-		.XXX±0.10		MM		size	
-		-		dr		M.CHEONG		A4	
-		-		engr		M.CHEONG		CUSTOMER Drawing	
-		-		chr		M.CHEONG			
-		-		appr		JOEY NG			
sheet		revision							
index		sheet							



PRODUCT NO.	NUMBER OF POSITIONS	DIMENSION		
		A	B	C
10069525-044***	2 X20	15.2	21.8	20.2
10069525-064***	2 X30	23.2	29.8	28.2
10069525-084***	2 X40	31.2	37.8	36.2
10069525-104***	2 X50	39.2	45.8	44.2
10069525-124***	2 X60	47.2	53.8	52.2
10069525-144***	2 X70	55.2	61.8	60.2
10069525-164***	2 X80	63.2	69.8	68.2
10069525-184***	2 X90	71.2	77.8	76.2
10069525-204***	2 X100	79.2	85.8	84.2

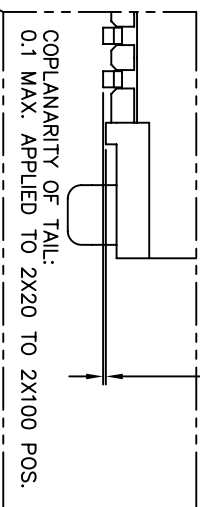
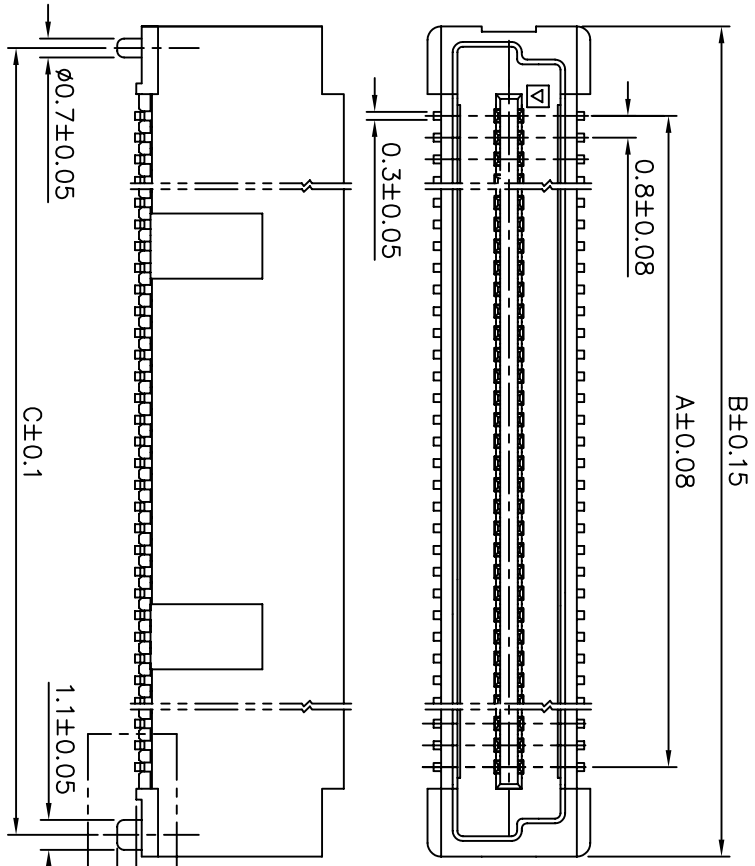

PLUG 4

mat'l. code		surface		tolerance		projection		product family	
ltr	ecrn no	dr	date	ASME Y14.5V	ASME Y14.5	MM	FCI	BERGSTAK	title
A	S06-0286	MCH	2006-08-25	angles	.XX±0.20	MM	FCI	0.8mm BOARD TO BOARD	
B	S06-0316	MCH	2006-08-25	∠±2°	.XXX±0.10	MM	FCI	PLUG ASS'Y	
				dr	M.CHEONG	2006-08-25			sheet 5 of 6
				enjr	M.CHEONG	2006-08-25			size A4
				chr	M.CHEONG	2006-08-25			
				appd	JOEY NG	2006-08-25			
sheet	revision								
index	sheet								

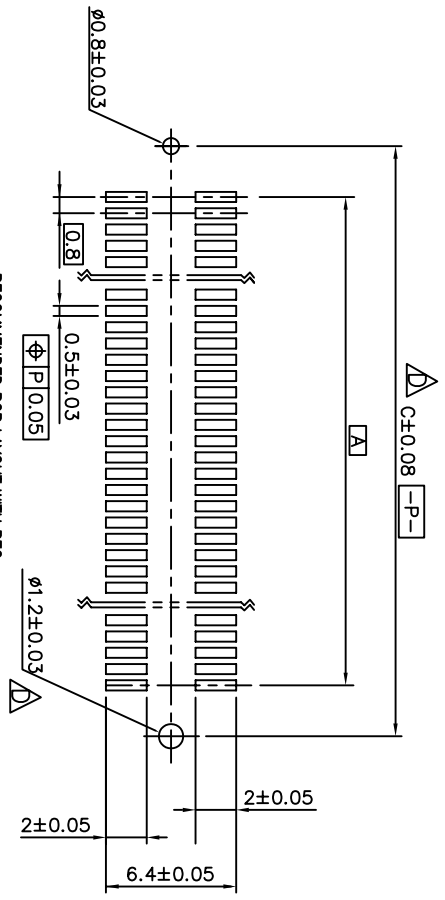
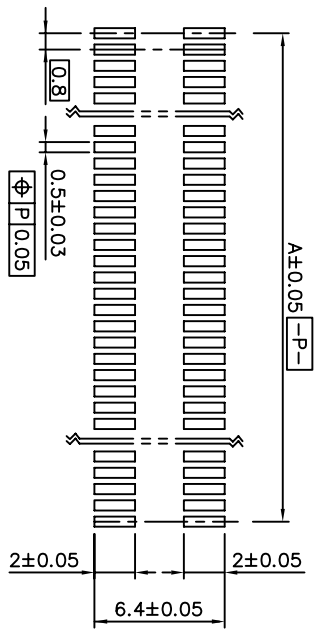
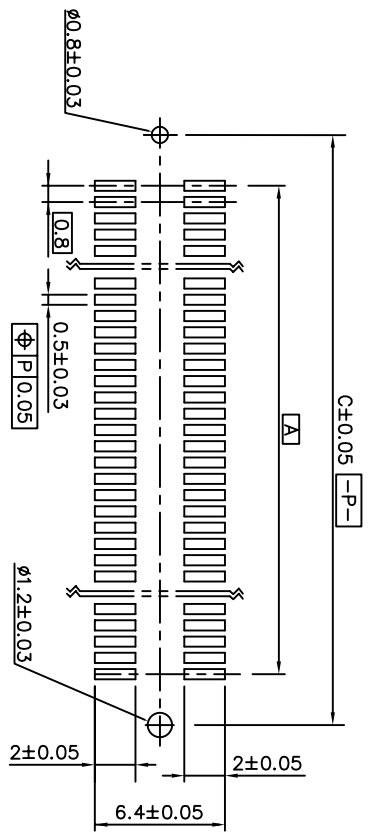

FOR PLUG 1/2/3/4

mat'l. code	surface	tolerance	projection	product family
	ASMEY14.5Y	ASME Y14.5		BERGSTAK
itr	ecrn no	dr	date	title
A	S06-0286	MCH	2006-08-25	0.8mm BOARD TO BOARD
B	S10-0086	MCH	2010-03-26	PLUG ASS'y
				scale 3:1
				MM
				dwg no
				10069525
				sheet 6 of 6
				size
				A4
Sheet	revision			type
index	sheet			CUSTOMER Drawing



Компания «ЭлектроПласт» предлагает заключение долгосрочных отношений при поставках импортных электронных компонентов на взаимовыгодных условиях!

Наши преимущества:

- Оперативные поставки широкого спектра электронных компонентов отечественного и импортного производства напрямую от производителей и с крупнейших мировых складов;
- Поставка более 17-ти миллионов наименований электронных компонентов;
- Поставка сложных, дефицитных, либо снятых с производства позиций;
- Оперативные сроки поставки под заказ (от 5 рабочих дней);
- Экспресс доставка в любую точку России;
- Техническая поддержка проекта, помощь в подборе аналогов, поставка прототипов;
- Система менеджмента качества сертифицирована по Международному стандарту ISO 9001;
- Лицензия ФСБ на осуществление работ с использованием сведений, составляющих государственную тайну;
- Поставка специализированных компонентов (Xilinx, Altera, Analog Devices, Intersil, Interpoint, Microsemi, Aeroflex, Peregrine, Syfer, Eurofarad, Texas Instrument, Miteq, Cobham, E2V, MA-COM, Hittite, Mini-Circuits, General Dynamics и др.);

Помимо этого, одним из направлений компании «ЭлектроПласт» является направление «Источники питания». Мы предлагаем Вам помощь Конструкторского отдела:

- Подбор оптимального решения, техническое обоснование при выборе компонента;
- Подбор аналогов;
- Консультации по применению компонента;
- Поставка образцов и прототипов;
- Техническая поддержка проекта;
- Защита от снятия компонента с производства.



Как с нами связаться

Телефон: 8 (812) 309 58 32 (многоканальный)

Факс: 8 (812) 320-02-42

Электронная почта: org@eplast1.ru

Адрес: 198099, г. Санкт-Петербург, ул. Калинина, дом 2, корпус 4, литера А.