

## PRODUCT OVERVIEW

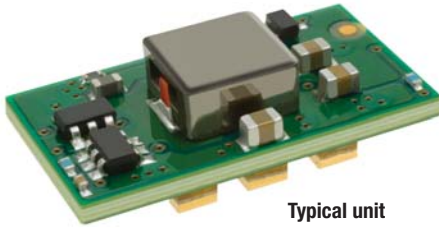

Typical unit

The OKY-T/3 and -T/5 series are miniature non-isolated Point-of-Load (POL) DC/DC power converters for embedded applications. The module is fully compatible with Distributed-power Open Standards Alliance (DOSA) industry-standard specifications ([www.dosapower.com](http://www.dosapower.com)). Applications include powering CPU's, datacom/telecom systems, programmable logic and mixed voltage systems.

The wide input range is 8.3 to 14 Volts DC. Two maximum output currents are offered, 3 Amps (T/3 models) or 5 Amps (T/5 models). Based on fixed-

frequency synchronous buck converter switching topology, the high power conversion efficient Point of Load (POL) module features programmable output voltage and On/Off control. These converters also include under voltage lock out (UVLO), output short circuit protection, over-current and over temperature protections.

These units are designed to meet all standard UL/EN/IEC 60950-1 safety and FCC EMI/RFI emissions certifications and RoHS-6 hazardous substance compliance.

## FEATURES

- Non-isolated SMT POL DC/DC power module
- 8.3-14Vdc input voltage range
- Programmable output voltage from 0.7525-5.5Vdc
- 3 Amp (T/3) or 5 Amp (T/5) output current models
- Drives 1000  $\mu$ F ceramic capacitive loads
- High power conversion efficiency 93% at 3.3 Vout
- Outstanding thermal derating performance
- Over temperature and over current protection
- On/Off control
- UL/EN/IEC 60950-1 safety
- Industry-standard (DOSA) surface-mount package
- RoHS-6 hazardous substance compliance

### Contents

	Page
Description, Connection Diagram, Photograph	1
Ordering Guide, Model Numbering	2
Mechanical Specifications, Input/Output Pinout	3
Detailed Electrical Specifications	4
Output Voltage Adjustment, Soldering Guidelines	5
Technical Notes	6
Product Label	8
OKY-T/3-D12 Performance Data and Oscillograms	9
OKY-T/5-D12 Performance Data and Oscillograms	15
Tape and Reel Information	21

## Connection Diagram

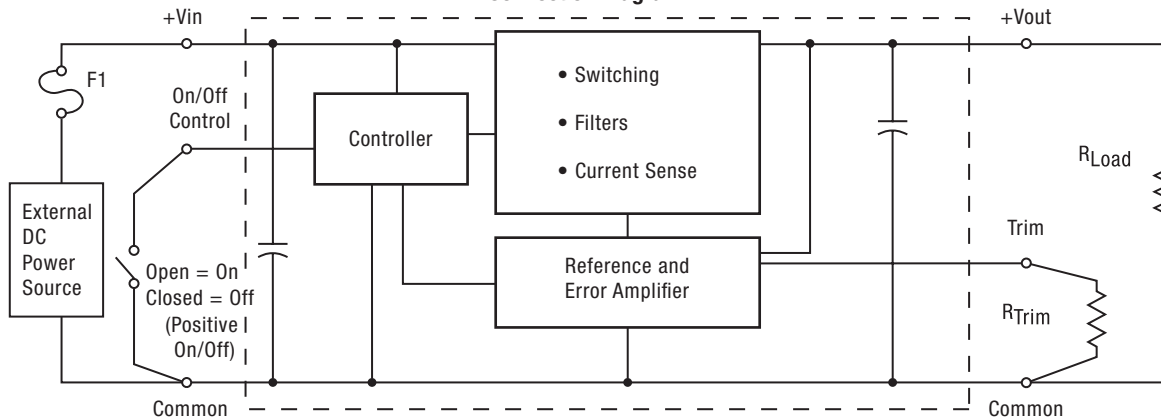

Figure 1. OKY-T/3, -T/5

Note: Murata Power Solutions strongly recommends an external input fuse, F1. See specifications.



**Performance Specifications Summary and Ordering Guide**

ORDERING GUIDE														
Root Model ②	Output						Input				Efficiency		Package	
	V <sub>OUT</sub> (Volts) ⑦	I <sub>OUT</sub> (Amps max)	Power (Watts)	R/N (mVp-p)⑤	Regulation (Max.)③		V <sub>IN</sub> Nom. (Volts)	Range (Volts)	I <sub>IN</sub> , no load (mA)	I <sub>IN</sub> , full load (Amps)	Min.	Typ.	Case C72 ①	Pinout
				Max.	Line	Load								
<b>OKY-T/3-D12N-C</b>	0.75-5.5 ⑦	3	15	25	±0.1%	±0.2%	12	8.3-14	80	1.34	91.5%	93%	0.47 x 0.82 x 0.28 (11.9 x 20.8 x 7.0)	P78
<b>OKY-T/3-D12P-C</b>	0.75-5.5 ⑦	3	15	25	±0.1%	±0.2%	12	8.3-14	80	1.34	91.5%	93%	0.47 x 0.82 x 0.28 (11.9 x 20.8 x 7.0)	P78
<b>OKY-T/5-D12N-C</b>	0.75-5.5 ⑥	5	25	25	±0.2%	±0.5%	12	8.3-14	80	2.24	91.5%	93%	0.47 x 0.82 x 0.28 (11.9 x 20.8 x 7.0)	P78
<b>OKY-T/5-D12P-C</b>	0.75-5.5 ⑥	5	25	25	±0.2%	±0.5%	12	8.3-14	80	2.24	91.5%	93%	0.47 x 0.82 x 0.28 (11.9 x 20.8 x 7.0)	P78

① Dimensions are in inches (mm).

② These are partial model numbers. Please refer to the part number structure for complete ordering part numbers.

③ All specifications are at nominal line voltage, V<sub>OUT</sub>=nominal (5V for D12 models) and full load, +25 °C, unless otherwise noted.

Output capacitors are 1 µF ceramic and 10 µF electrolytic in parallel. Input cap is 22 µF. See detailed specifications.

I/O caps are necessary for our test equipment and may not be needed for your application.

④ V<sub>IN</sub> must be 2V or higher than V<sub>OUT</sub> for 3.3 to 5V outputs.

⑤ Ripple and Noise is shown at V<sub>OUT</sub>=1V. See specs for details.

⑥ Max. V<sub>OUT</sub> = 5.1V at I<sub>OUT</sub> = 5A.

⑦ Max. V<sub>OUT</sub> = 5.1V at I<sub>OUT</sub> = 3A.

**PART NUMBER STRUCTURE**

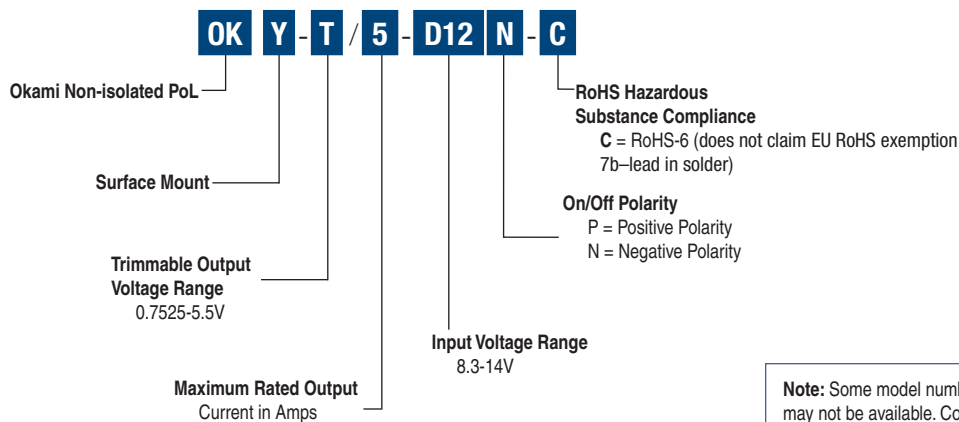

**Note:** Some model number combinations may not be available. Contact Murata Power Solutions for availability.

Special Customer Configuration part number:  
OKY-T/5-D12N-C-CIS

**MECHANICAL SPECIFICATIONS**

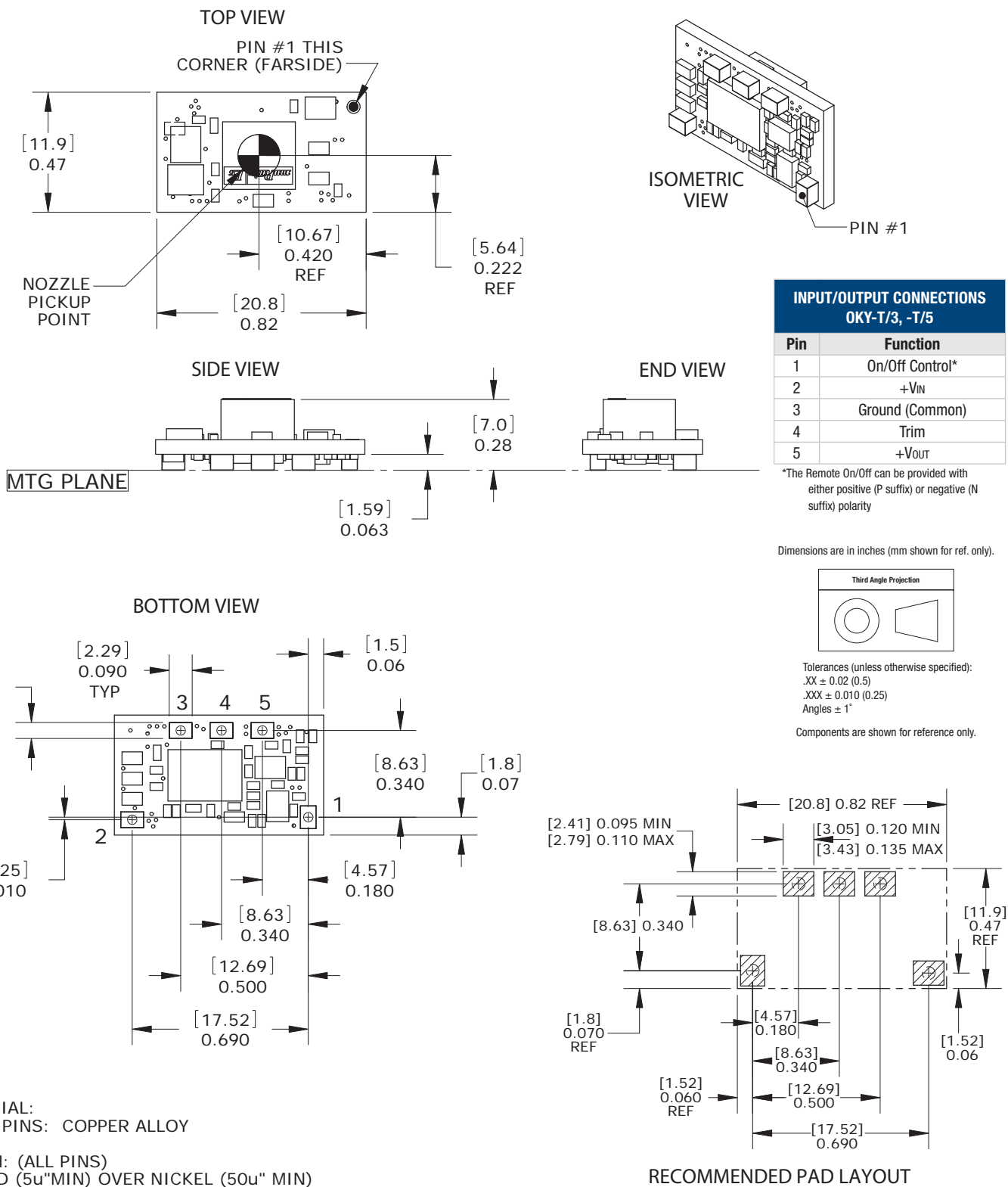

MATERIAL:  
SMT PINS: COPPER ALLOY

FINISH: (ALL PINS)  
GOLD (5u"MIN) OVER NICKEL (50u" MIN)

Figure 2. OKY-T/3, -T/5 Mechanical Outline

**Performance and Functional Specifications**

See Note 1

Input	
Input Voltage Range	See Ordering Guide and Note 7.
Isolation	Not isolated
Start-Up Voltage	7.5 V. min, 8.25 V. max
Undervoltage Shutdown (see Note 15)	7.3 V. min, 8.05 V. max
Overvoltage Shutdown	None
Reflected (Back) Ripple Current (Note 2)	20 mA pk-pk
Internal Input Filter Type	Capacitive
Recommended External Fuse	6A
Reverse Polarity Protection	N/A. See fuse information.
Input Current:	
Full Load Conditions	See Ordering Guide
Inrush Transient	0.4 A2Sec.
Shutdown Mode (Off, UV, OT)	5 mA
Output in Short Circuit	60 mA
Low Line (Vin=Vmin, 5Vout)	1.93 A. (OKY-T/3-D12) 3.24 A. (OKY-T/5-D12)
Remote On/Off Control (Note 5)	
Negative Logic ("N" model suffix)	ON = Open pin or ground to +0.4V. max. OFF = +1.5V min. to +Vin
Current	1 mA max.
Positive Logic ("P" model suffix)	ON = Open pin (internally pulled up) or +7.8Vdc to +Vin max. OFF = Ground pin to +0.4V. max.
Current	1 mA max.
Output	
Output Power	15W max. (OKY-T/3) 25W max. (OKY-T/5)
Output Voltage Range	See Ordering Guide
Minimum Loading	No minimum load
Accuracy (50% load, untrimmed)	±2 % of Vnominal
Voltage Output Range (Note 13)	See Ordering Guide
Overvoltage Protection (Note 16)	None
Temperature Coefficient	±0.02% per °C of Vout range
Ripple/Noise (20 MHz bandwidth)	See Ordering Guide and note 8
Line/Load Regulation	See Ordering Guide and note 10
Efficiency	See Ordering Guide
Maximum Capacitive Loading (Note 14)	
Cap-ESR=0.001 to 0.01 Ohms	1,000 µF
Cap-ESR >0.01 Ohms	3,000 µF
Current Limit Inception (Note 6) (98% of Vout setting, after warm up)	7.5 Amps max.
Short Circuit Mode	
Short Circuit Current Output	2 A
Protection Method	Hiccup autorecovery upon overload removal. (Note 17)
Short Circuit Duration	Continuous, no damage (output shorted to ground)
Prebias Startup	Converter will start up if the external output voltage is less than Vnominal.
Dynamic Characteristics	
Dynamic Load Response (50-100-50% load step, di/dt=2.5A/µSec)	90µSec max. to within ±2% of final value
Start-Up Time (Vin on or On/Off to Vout regulated)	8 mSec for Vout=nominal
Switching Frequency	320 KHz

Environmental	
Calculated MTBF Telcordia method (4a)	OKY-T/3-D12N-C: 10,155,200 hours OKY-T/5-D12P-C: 10,727,300 hours OKY-T/5-D12N-C: 11,763,400 hours
Calculated MTBF MIL-HDBK-217N2 method (4b)	OKY-T/3-D12N-C: 6,309,035 hours OKY-T/5-D12P-C: 5,768,500 hours OKY-T/5-D12N-C: 5,866,256 hours
Operating Temperature Range (Ambient, vertical mount) See derating curves	
	-40 to +85 °C. with derating (Note 9)
Operating PC Board Temperature	-40 to +100 °Celsius max., no derating (12)
Storage Temperature Range	-55 to +125 deg. C.
Thermal Protection/Shutdown	+130 °Celsius
Relative Humidity	to 85%/+85 °C., non-condensing
Physical	
Outline Dimensions	See Mechanical Specifications
Weight	0.1 ounces (2.8 grams)
Electromagnetic Interference	Designed to meet FCC part 15, class B, EN55022 and CISPR22 class B conducted and radiated (may need external filter)
Safety	Designed to meet UL/cUL 60950-1, CSA-C22.2 No. 60950-1, IEC/EN 60950-1
Restriction of Hazardous Substances	RoHS-6 (does not claim EU RoHS exemption 7b-lead in solder)
MSL Rating	2
Absolute Maximum Ratings	
Input Voltage (Continuous or transient)	0 V. to +15 Volts max.
On/Off Control	0 V. min. to +Vin max.
Input Reverse Polarity Protection	See Fuse section
Output Current (Note 7)	Current-limited. Devices can withstand a sustained short circuit without damage. The outputs are not intended to accept appreciable reverse current.
Storage Temperature	-55 to +125 °C.
Lead Temperature	See soldering specifications
Absolute maximums are stress ratings. Exposure of devices to greater than any of any of these conditions may adversely affect long-term reliability. Proper operation under conditions other than those listed in the Performance/Functional Specifications Table is not implied or recommended.	

**Specification Notes:**

- Specifications are typical at +25 °C, Vin=nominal (+12V), Vout=nominal (+5V), full load, external caps and natural convection unless otherwise indicated. Extended tests at full power must supply substantial forced airflow.  
All models are tested and specified with external 1 µF paralleled with 10µF ceramic/tantalum output capacitors and a 22 µF external input capacitor. All capacitors are low ESR types. These capacitors are necessary to accommodate our test equipment and may not be required to achieve specified performance in your applications. However, Murata Power Solutions recommends installation of these capacitors. All models are stable and regulate within spec under no-load conditions.
- Input Back Ripple Current is tested and specified over a 5 Hz to 20 MHz bandwidth. Input filtering is Cin=2 x 100 µF tantalum, Cbus=1000 µF electrolytic, Lbus=1 µH.
- Note that Maximum Power Derating curves indicate an average current at nominal input voltage. At higher temperatures and/or lower airflow, the DC/DC converter will tolerate brief full current outputs if the total RMS current over time does not exceed the Derating curve.
- (4a) Mean Time Before Failure is calculated using the Telcordia (Belcore) SR-332 Method 1, Case 3, ground fixed conditions, Tpcboard=+25 °C, full output load, natural air convection.
- (4b) Mean Time Before Failure is calculated using the MIL-HDBK-217N2 method, ground benign, +25°C., full output load, natural convection.

**Specification Notes, Cont.:**

- (5) The On/Off Control Input should use either a switch or an open collector/open drain transistor referenced to -Input Common. A logic gate may also be used by applying appropriate external voltages which do not exceed +Vin.
- (6) Short circuit shutdown begins when the output voltage degrades approximately 2% from the selected setting.
- (7) For W5 models, the Input Voltage must exceed the Output Voltage at all times by the ratio of Vin >= (1.15 x Vout). Please see the separate W5 data sheet.
- (8) Output noise may be further reduced by adding an external filter. At zero output current, the output may contain low frequency components which exceed the ripple specification. The output may be operated indefinitely with no load.
- (9) All models are fully operational and meet published specifications, including "cold start" at -40° C.
- (10) Regulation specifications describe the deviation as the line input voltage or output load current is varied from a nominal midpoint value to either extreme.
- (11) Other input or output voltage ranges will be reviewed under scheduled quantity special order.
- (12) Maximum PC board temperature is measured with the sensor in the center of the converter.
- (13) Do not exceed maximum power specifications when adjusting the output trim.
- (14) The maximum output capacitive loads depend on the the Equivalent Series Resistance (ESR) of the external output capacitor and, to a lesser extent, the distance and series impedance to the load. Larger caps will reduce output noise but may change the transient response. Newer ceramic caps with very low ESR may require lower capacitor values to avoid instability. Thoroughly test your capacitors in the application. Please refer to the Output Capacitive Load Application Note.
- (15) Do not allow the input voltage to degrade lower than the input undervoltage shutdown voltage at all times. Otherwise, you risk having the converter turn off. The undervoltage shutdown is not latching and will attempt to recover when the input is brought back into normal operating range.
- (16) The outputs are not intended to sink appreciable reverse current.
- (17) "Hiccup" overcurrent operation repeatedly attempts to restart the converter with a brief, full-current output. If the overcurrent condition still exists, the restart current will be removed and then tried again. This short current pulse prevents overheating and damaging the converter. Once the fault is removed, the converter immediately recovers normal operation.

**Output Voltage Adjusment**

The output voltage may be adjusted over a limited range by connecting an external trim resistor (Rtrim) between the Trim pin and Ground. The Rtrim resistor must be a 1/10 Watt precision metal film type, ±1% accuracy or better with low temperature coefficient, ±100 ppm/oC. or better. Mount the resistor close to the converter with very short leads or use a surface mount trim resistor.

In the tables below, the calculated resistance is given. Do not exceed the specified limits of the output voltage or the converter's maximum power rating when applying these resistors. Also, avoid high noise at the Trim input. However, to prevent instability, you should never connect any capacitors to Trim.

**OKY-T/3-D12, -T/5-D12**

Output Voltage	Calculated Rtrim (KΩ)
5.0 V.	1.472
3.3 V.	3.122
2.5 V.	5.009
2.0 V.	7.416
1.8 V.	9.024
1.5 V.	13.05
1.2 V.	22.46
1.0 V.	41.424
0.7525 V.	∞ (open)

**Resistor Trim Equation, D12 models:**

$$R_{TRIM} (\Omega) = \frac{10500}{V_{OUT} - 0.7525V} - 1000$$

**Soldering Guidelines**

Murata Power Solutions recommends the specifications below when installing these converters. These specifications vary depending on the solder type. Exceeding these specifications may cause damage to the product. Your production environment may differ therefore please thoroughly review these guidelines with your process engineers.

Reflow Solder Operations for surface-mount products (SMT)	
<b>For Sn/Ag/Cu based solders:</b>	
Preheat Temperature	Less than 1 °C. per second
Time over Liquidus	45 to 75 seconds
Maximum Peak Temperature	260 °C.
Cooling Rate	Less than 3 °C. per second
<b>For Sn/Pb based solders:</b>	
Preheat Temperature	Less than 1 °C. per second
Time over Liquidus	60 to 75 seconds
Maximum Peak Temperature	235 °C.
Cooling Rate	Less than 3 °C. per second

**Recommended Lead-free Solder Reflow Profile**

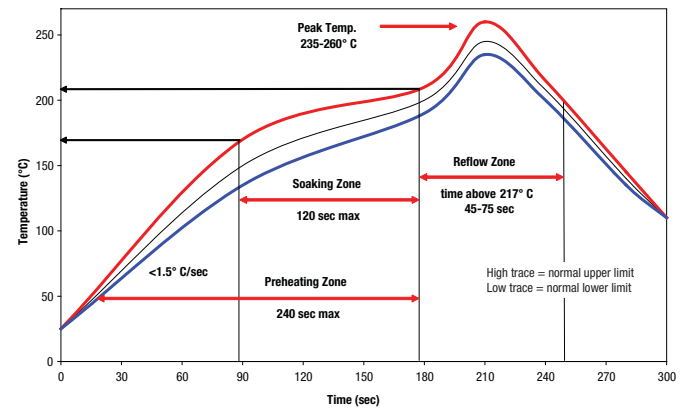

High trace = normal upper limit

Low trace - normal lower limit

TECHNICAL NOTES

**Input Fusing**

Certain applications and/or safety agencies may require fuses at the inputs of power conversion components. Fuses should also be used when there is the possibility of sustained input voltage reversal which is not current-limited. We recommend a time delay fuse installed in the ungrounded input supply line with a value which is approximately twice the maximum line current, calculated at the lowest input voltage.

The installer must observe all relevant safety standards and regulations. For safety agency approvals, install the converter in compliance with the end-user safety standard, i.e. IEC/EN/UL 60950-1.

**Input Under-Voltage Shutdown and Start-Up Threshold**

Under normal start-up conditions, converters will not begin to regulate properly until the ramping-up input voltage exceeds and remains at the Start-Up Threshold Voltage (see Specifications). Once operating, converters will not turn off until the input voltage drops below the Under-Voltage Shutdown Limit. Subsequent restart will not occur until the input voltage rises again above the Start-Up Threshold. This built-in hysteresis prevents any unstable on/off operation at a single input voltage.

Users should be aware however of input sources near the Under-Voltage Shutdown whose voltage decays as input current is consumed (such as capacitor inputs), the converter shuts off and then restarts as the external capacitor recharges. Such situations could oscillate. To prevent this, make sure the operating input voltage is well above the UV Shutdown voltage AT ALL TIMES.

**Start-Up Time**

Assuming that the output current is set at the rated maximum, the Vin to Vout Start-Up Time (see Specifications) is the time interval between the point when the ramping input voltage crosses the Start-Up Threshold and the fully loaded regulated output voltage enters and remains within its specified accuracy band. Actual measured times will vary with input source impedance, external input capacitance, input voltage slew rate and final value of the input voltage as it appears at the converter.

These converters include a soft start circuit to moderate the duty cycle of its PWM controller at power up, thereby limiting the input inrush current.

The On/Off Remote Control interval from On command to Vout regulated assumes that the converter already has its input voltage stabilized above the Start-Up Threshold before the On command. The interval is measured from the On command until the output enters and remains within its specified accuracy band. The specification assumes that the output is fully loaded at maximum rated current. Similar conditions apply to the On to Vout regulated specification such as external load capacitance and soft start circuitry.

**Recommended Input Filtering**

The user must assure that the input source has low AC impedance to provide dynamic stability and that the input supply has little or no inductive content,

including long distributed wiring to a remote power supply. The converter will operate with no additional external capacitance if these conditions are met.

For best performance, we recommend installing a low-ESR capacitor immediately adjacent to the converter's input terminals. The capacitor should be a ceramic type such as the Murata GRM32 series or a polymer type. Initial suggested capacitor values are 10 to 22  $\mu$ F, rated at twice the expected maximum input voltage. Make sure that the input terminals do not go below the undervoltage shutdown voltage at all times. More input bulk capacitance may be added in parallel (either electrolytic or tantalum) if needed.

**Recommended Output Filtering**

The converter will achieve its rated output ripple and noise with no additional external capacitor. However, the user may install more external output capacitance to reduce the ripple even further or for improved dynamic response. Again, use low-ESR ceramic (Murata GRM32 series) or polymer capacitors. Initial values of 10 to 47  $\mu$ F may be tried, either single or multiple capacitors in parallel. Mount these close to the converter. Measure the output ripple under your load conditions.

Use only as much capacitance as required to achieve your ripple and noise objectives. Excessive capacitance can make step load recovery sluggish or possibly introduce instability. Do not exceed the maximum rated output capacitance listed in the specifications.

**Input Ripple Current and Output Noise**

All models in this converter series are tested and specified for input reflected ripple current and output noise using designated external input/output components, circuits and layout as shown in the figures below. The Cbus and Lbus components simulate a typical DC voltage bus. Please note that the values of Cin, Lbus and Cbus will vary according to the specific converter model.

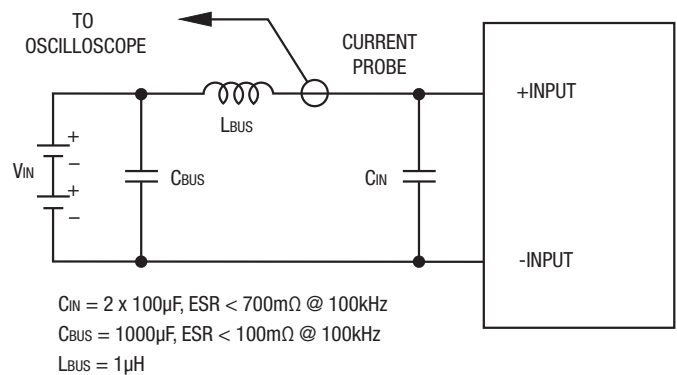

Figure 2. Measuring Input Ripple Current

In figure 3, the two copper strips simulate real-world printed circuit impedances between the power supply and its load. In order to minimize circuit errors and standardize tests between units, scope measurements should be made using BNC connectors or the probe ground should not exceed one half-inch and soldered directly to the test circuit.



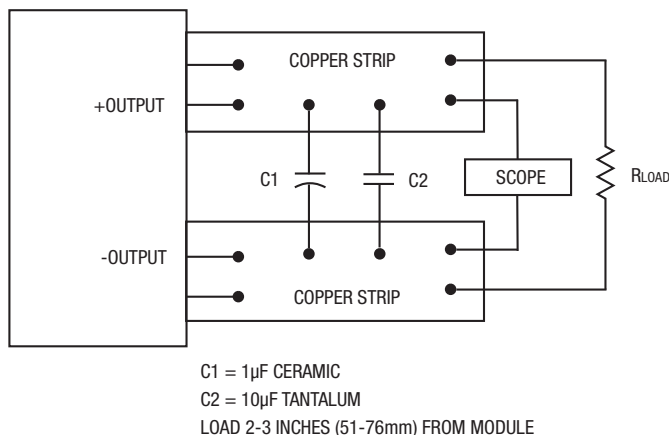

Figure 3. Measuring Output Ripple and Noise (PARD)

**Minimum Output Loading Requirements**

All models regulate within specification and are stable under no load to full load conditions. Operation under no load might however slightly increase output ripple and noise.

**Thermal Shutdown**

To prevent many over temperature problems and damage, these converters include thermal shutdown circuitry. If environmental conditions cause the temperature of the DC/DC's to rise above the Operating Temperature Range up to the shutdown temperature, an on-board electronic temperature sensor will power down the unit. When the temperature decreases below the turn-on threshold, the converter will automatically restart. There is a small amount of hysteresis to prevent rapid on/off cycling.

**CAUTION:** If you operate too close to the thermal limits, the converter may shut down suddenly without warning. Be sure to thoroughly test your application to avoid unplanned thermal shutdown.

**Temperature Derating Curves**

The graphs in this data sheet illustrate typical operation under a variety of conditions. The Derating curves show the maximum continuous ambient air temperature and decreasing maximum output current which is acceptable under increasing forced airflow measured in Linear Feet per Minute (“LFM”). Note that these are AVERAGE measurements. The converter will accept brief increases in current or reduced airflow as long as the average is not exceeded.

Note that the temperatures are of the ambient airflow, not the converter itself which is obviously running at higher temperature than the outside air. Also note that “natural convection” is defined as very low flow rates which are not using fan-forced airflow. Depending on the application, “natural convection” is usually about 30-65 LFM but is not equal to still air (0 LFM).

Murata Power Solutions makes Characterization measurements in a closed cycle wind tunnel with calibrated airflow. We use both thermocouples and an infrared camera system to observe thermal performance. As a practical matter, it is quite difficult to insert an anemometer to precisely measure airflow in most applications. Sometimes it is possible to estimate the effective airflow if you thoroughly understand the enclosure geometry, entry/exit orifice areas and the fan flowrate specifications.

**CAUTION:** If you routinely or accidentally exceed these Derating guidelines, the converter may have an unplanned Over Temperature shut down. Also, these graphs are all collected at slightly above Sea Level altitude. Be sure to reduce the derating for higher density altitude.

**Output Fusing**

The converter is extensively protected against current, voltage and temperature extremes. However your output application circuit may need additional protection. In the extremely unlikely event of output circuit failure, excessive voltage could be applied to your circuit. Consider using an appropriate fuse in series with the output.

**Output Current Limiting**

Current limiting inception is defined as the point at which full power falls below the rated tolerance. See the Performance/Functional Specifications. Note particularly that the output current may briefly rise above its rated value in normal operation as long as the average output power is not exceeded. This enhances reliability and continued operation of your application. If the output current is too high, the converter will enter the short circuit condition.

**Output Short Circuit Condition**

When a converter is in current-limit mode, the output voltage will drop as the output current demand increases. If the output voltage drops too low (approximately 98% of nominal output voltage for most models), the magnetically coupled voltage used to develop primary side voltages will also drop, thereby shutting down the PWM controller. Following a time-out period, the PWM will restart, causing the output voltage to begin ramping up to its appropriate value. If the short-circuit condition persists, another shutdown cycle will initiate. This rapid on/off cycling is called “hiccup mode”. The hiccup cycling reduces the average output current, thereby preventing excessive internal temperatures and/or component damage. A short circuit can be tolerated indefinitely.

The “hiccup” system differs from older latching short circuit systems because you do not have to power down the converter to make it restart. The system will automatically restore operation as soon as the short circuit condition is removed.

**Remote On/Off Control**

On the input side, a remote On/Off Control can be ordered with either polarity. Please refer to the Connection Diagram on page 1 for On/Off connections.

Positive-polarity models are enabled when the On/Off pin is left open or is pulled high to +Vin with respect to -Vin. Positive-polarity devices are disabled when the On/Off is grounded or brought to within a low voltage (see Specifications) with respect to -Vin.

Negative-polarity devices are on (enabled) when the On/Off is left open or brought to within a low voltage (see Specifications) with respect to -Vin. The device is off (disabled) when the On/Off is pulled high (see Specifications) with respect to -Vin.

Dynamic control of the On/Off function should be able to sink appropriate signal current when brought low and withstand appropriate voltage when brought high. Be aware too that there is a finite time in milliseconds (see Specifications) between the time of On/Off Control activation and stable, regulated output. This time will vary slightly with output load type and current and input conditions.

**Output Capacitive Load**

These converters do not require external capacitance added to achieve rated specifications. Users should only consider adding capacitance to reduce switching noise and/or to handle spike current load steps. Install only enough capacitance to achieve noise objectives. Excess external capacitance may cause regulation problems, degraded transient response and possible oscillation or instability.

The maximum rated output capacitance and ESR specification is given for a capacitor installed immediately adjacent to the converter. Any extended output wiring or smaller wire gauge or less ground plane may tolerate somewhat higher capacitance. Also, capacitors with higher ESR may have a larger capacitance. What counts here is the instantaneous maximum output current during power-on charge-up and switching currents under load. Excessive current will trip the overcurrent detection and shut off the converter.

**Product Label**

Because of the small size of these products, the product label contains a character-reduced code to indicate the model number and manufacturing date code. Not all items on the label are always used. Please note that the label differs from the product photograph on page 1. Here is the layout of the label:

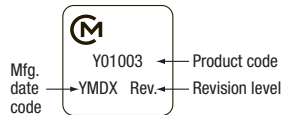

Figure 4. Label Artwork Layout

The label contains three rows of information:

- First row – Murata Power Solutions logo
- Second row – Model number product code (see table)
- Third row – Manufacturing date code and revision level

Model Number	Product Code
OKY-T/3-D12N-C	Y00103
OKY-T/3-D12P-C	Y01103
OKY-T/5-D12N-C	Y00105
OKY-T/5-D12P-C	Y01105
OKY-T/5-D12N-C-CIS	YC00105

The manufacturing date code is four characters:

- First character – Last digit of manufacturing year, example 200**9**
- Second character – Month code (1 through 9 and 0 through D)
- Third character – Day code (1 through 9 = 1 to 9, 10 = 0 and 11 through 31 = A through Z)
- Fourth character – Manufacturing information



**OKY-T/3-D12 PERFORMANCE DATA: Vout = .75V**

OKY-T/3-D12 Maximum Current Temperature Derating @ Sea Level  
(VIN = 12V, VOUT = .75V, airflow is transverse)

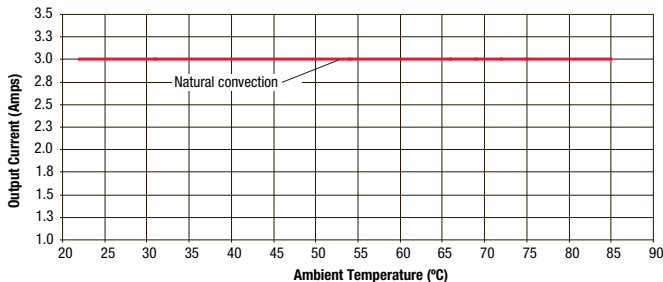

**OKY-T/3-D12 OSCILLOGRAMS: Vout = .75V**

OKY-T/3-D12 Output Ripple and Noise  
(VIN=12V, Vout=0.75V, Iout=3A, Cload=0, ScopeBW=100MHz)

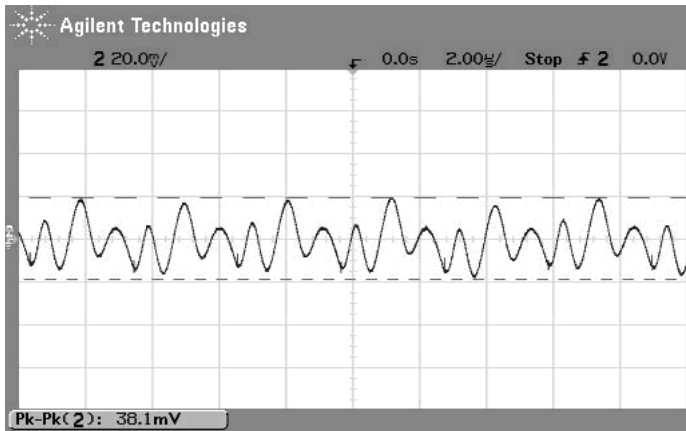

On/Off Enable Startup Delay (VIN=12V, Vout=0.75V, Iout=3A, Cload=0)  
Trace 4=Enable In, Trace2=Vout

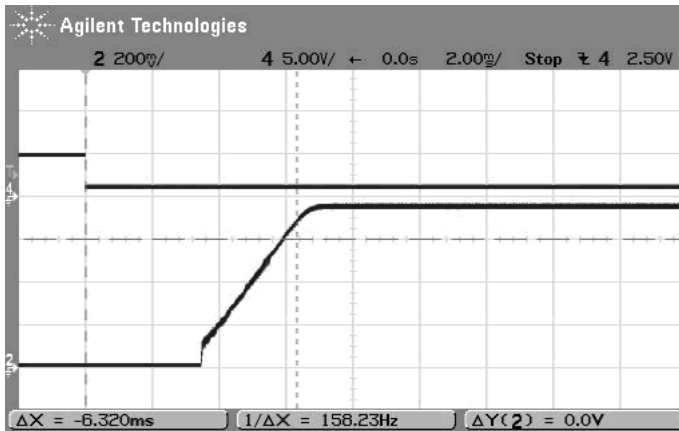

**OKY-T/3-D12 PERFORMANCE DATA: Vout = 1V**

OKY-T/3-D12 Efficiency vs. Line Voltage and Load Current @ 25°C (Vout = 1V)

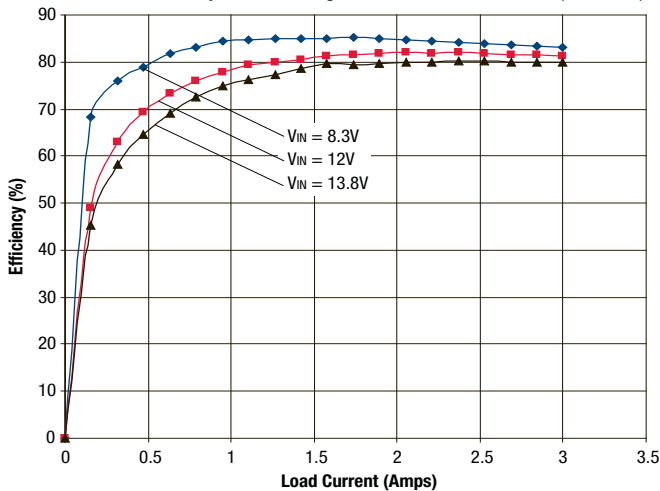

OKY-T/3-D12 Maximum Current Temperature Derating @ Sea Level  
(VIN = 12V, VOUT = 1V, airflow is transverse)

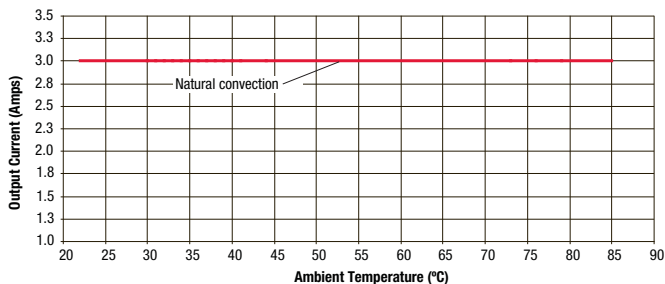

**OKY-T/3-D12 PERFORMANCE DATA: Vout = 1.2V**

OKY-T/3-D12 Efficiency vs. Line Voltage and Load Current @ 25°C (Vout = 1.2V)

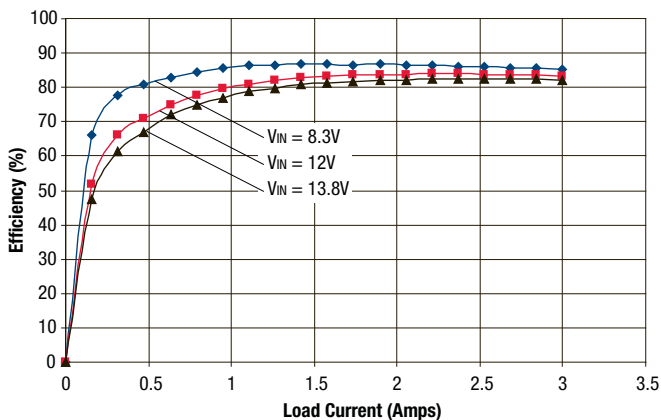

OKY-T/3-D12 Maximum Current Temperature Derating @ Sea Level (VIN = 12V, VOUT = 1.2V, airflow is transverse)

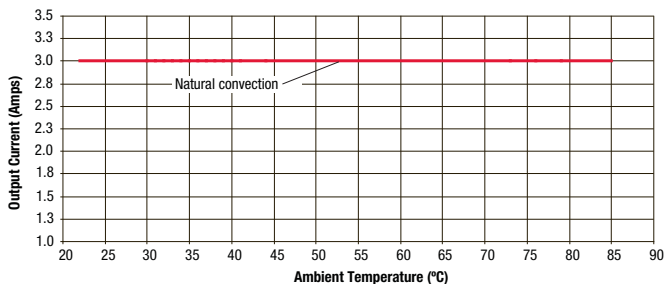

**OKY-T/3-D12 OSCILLOGRAMS: Vout = 1.2V**

Output Ripple and Noise (Vin=12V, Vout=1.2V, Iout=3A, Cload=0, ScopeBW=100MHz)

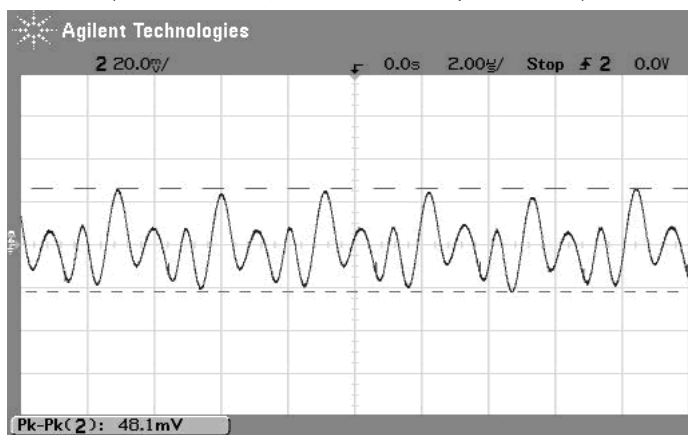

On/Off Enable Startup Delay (Vin=12V, Vout=1.2V, Iout=3A, Cload=0) Trace 4=Enable In, Trace2=Vout

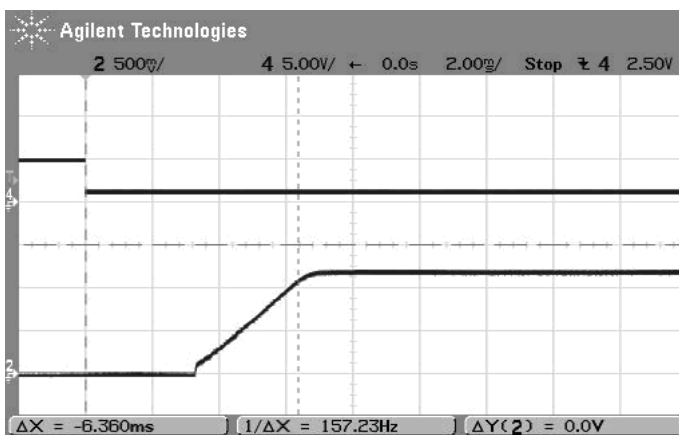

Step Load Transient Response (Vin=12V, Vout=1.2V, Cload=0, Iout=1.5A to 3A) Trace 1=Vout, 50 mV/div. Trace 3=Iout, 1A/div.

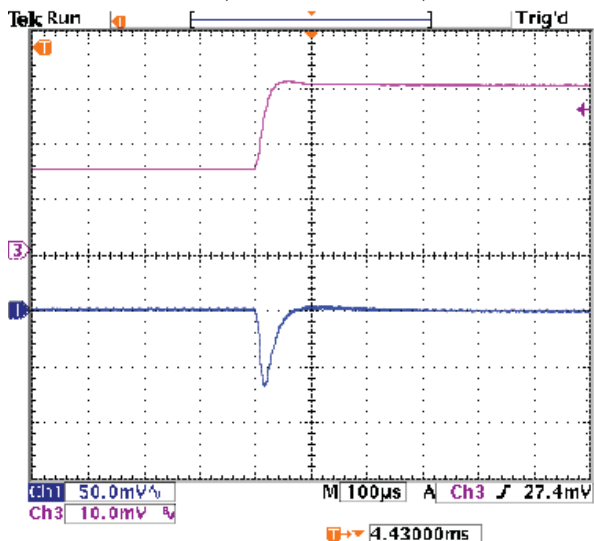

Step Load Transient Response (Vin=12V, Vout=1.2V, Cload=0, Iout=3A to 1.5A) Trace 1=Vout, 50 mV/div. Trace 3=Iout, 1A/div.

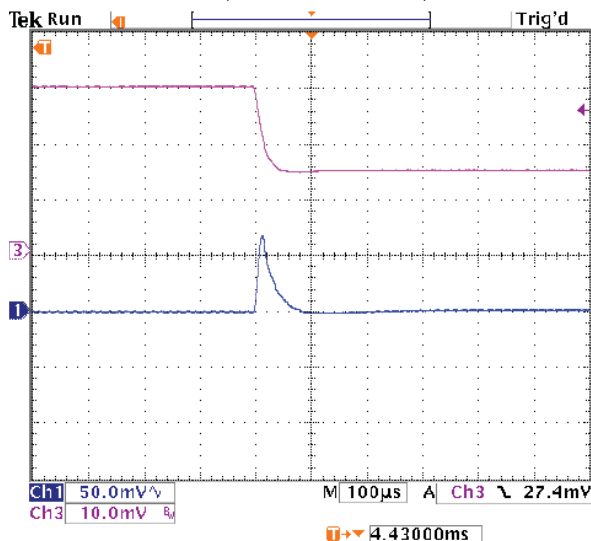

**OKY-T/3-D12 PERFORMANCE DATA: Vout = 1.5V**

OKY-T/3-D12 Efficiency vs. Line Voltage and Load Current @ 25°C (Vout = 1.5V)

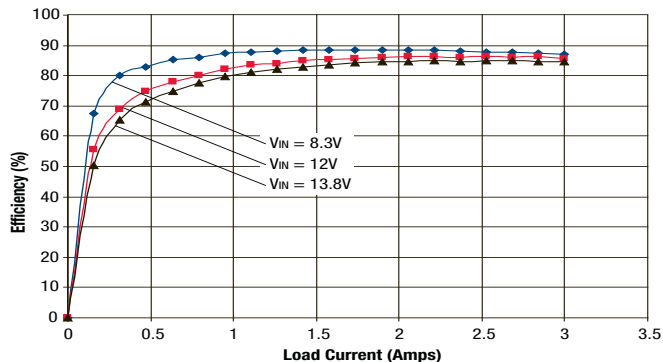

OKY-T/3-D12 Maximum Current Temperature Derating @ Sea Level (VIN = 12V, Vout = 1.5V, airflow is transverse)

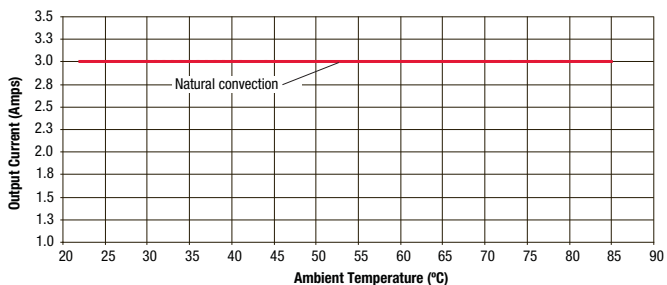

**OKY-T/3-D12 PERFORMANCE DATA: Vout = 1.8V**

OKY-T/3-D12 Efficiency vs. Line Voltage and Load Current @ 25°C (Vout = 1.8V)

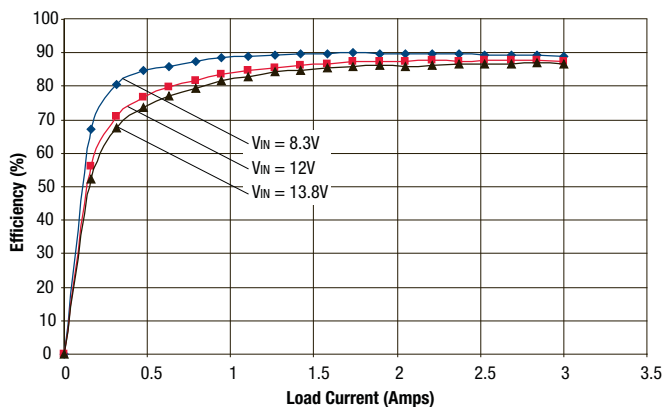

OKY-T/3-D12 Maximum Current Temperature Derating @ Sea Level (VIN = 12V, Vout = 1.8V, airflow is transverse)

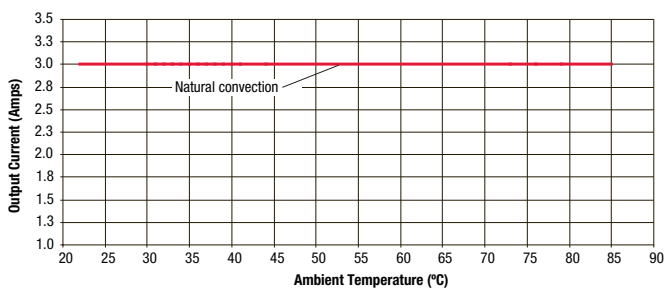

**OKY-T/3-D12 PERFORMANCE DATA: Vout = 2.5V**

OKY-T/3-D12 Efficiency vs. Line Voltage and Load Current @ 25°C (Vout = 2.5V)

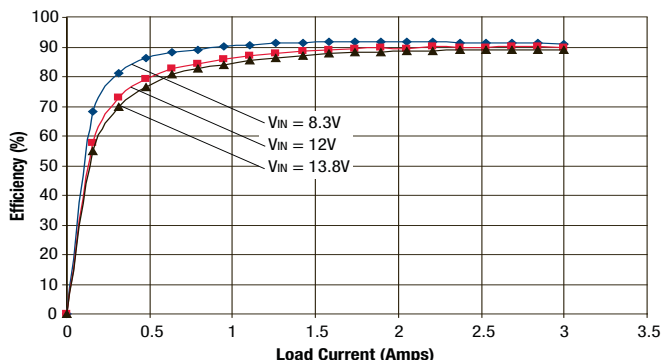

OKY-T/3-D12 Maximum Current Temperature Derating @ Sea Level (VIN = 12V, Vout = 2.5V, airflow is transverse)

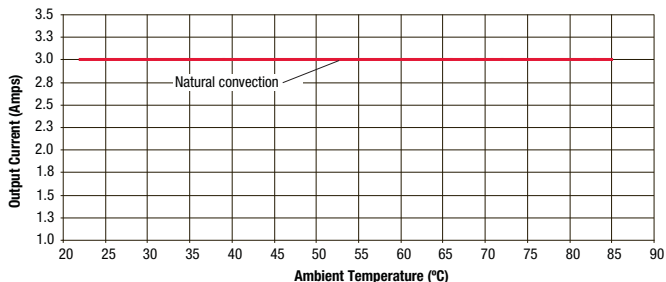

**OKY-T/3-D12 OSCILLOGRAMS: Vout = 2.5V**

Output Ripple and Noise (Vin=12V, Vout=2.5V, Iout=3A, Cload=0, ScopeBW=100MHz)

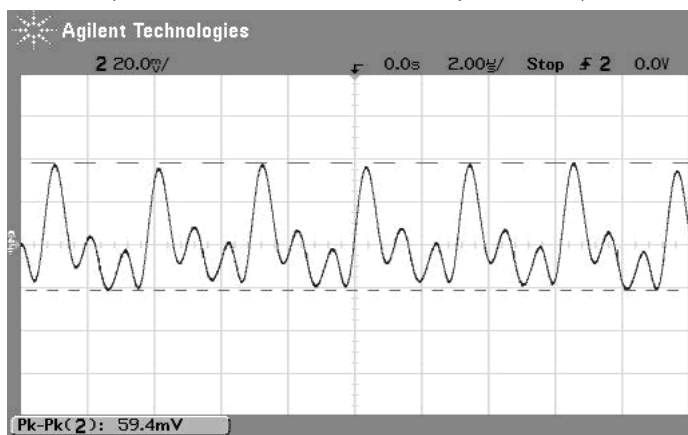

On/Off Enable Startup Delay (Vin=12V, Vout=2.5V, Iout=3A, Cload=0) Trace 4=Enable In, Trace 2=Vout

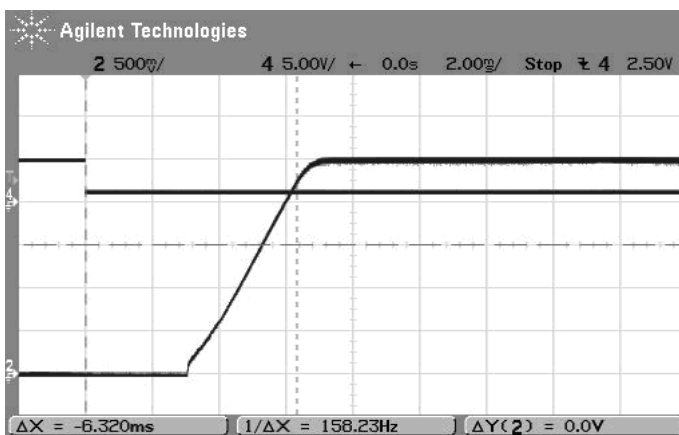

Step Load Transient Response (Vin=12V, Vout=2.5V, Cload=0, Iout=1.5A to 3A) Trace 1=Vout, 50 mV/div. Trace 3=Iout, 1A/div.

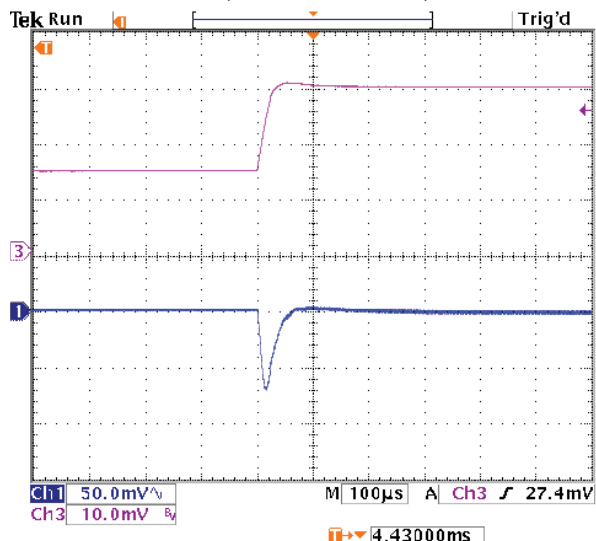

Step Load Transient Response (Vin=12V, Vout=2.5V, Cload=0, Iout=3A to 1.5A) Trace 1=Vout, 50 mV/div. Trace 3=Iout, 1A/div.

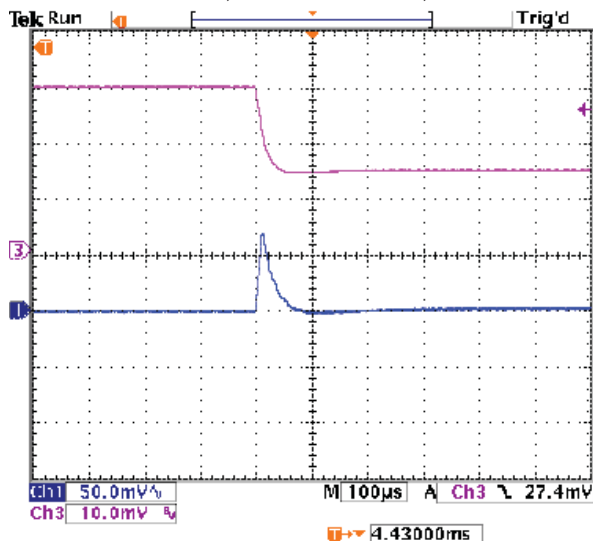

**OKY-T/3-D12 PERFORMANCE DATA: Vout = 3.3V**

OKY-T/3-D12 Efficiency vs. Line Voltage and Load Current @ 25°C (Vout = 3.3V)

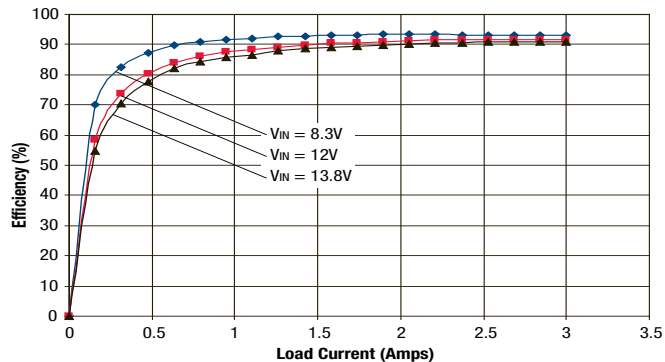

OKY-T/3-D12 Maximum Current Temperature Derating @ Sea Level (VIN = 12V, Vout = 3.3V, airflow is transverse)

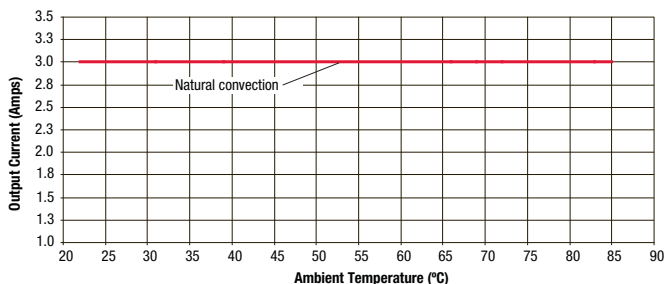

**OKY-T/3-D12 OSCILLOGRAMS: Vout = 3.3V**

Output Ripple and Noise (Vin=12V, Vout=3.3V, Iout=3A, Cload=0, ScopeBW=100MHz)

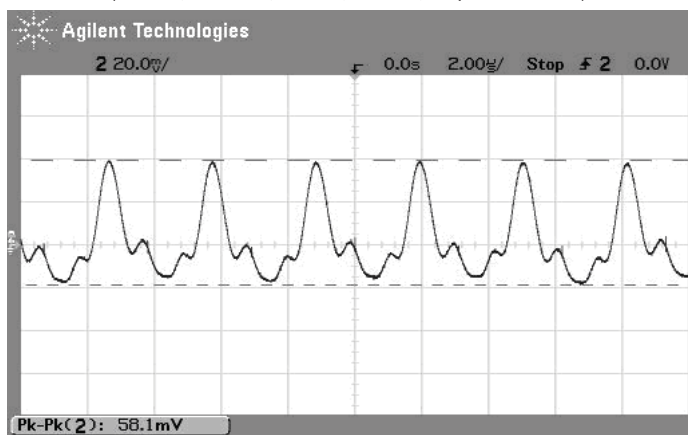

On/Off Enable Startup Delay (Vin=12V, Vout=3.3V, Iout=0.04A, Cload=0) Trace 4=Enable In, Trace 2=Vout

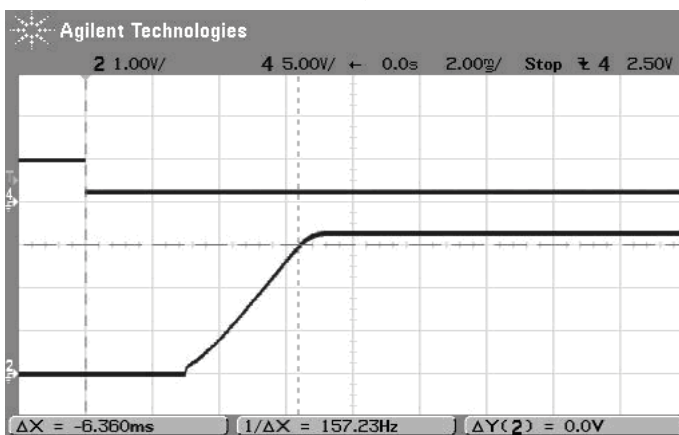

Step Load Transient Response (Vin=12V, Vout=3.3V, Cload=0, Iout=1.5A to 3A) Trace 1=Vout, 50 mV/div. Trace 3=Iout, 1A/div.

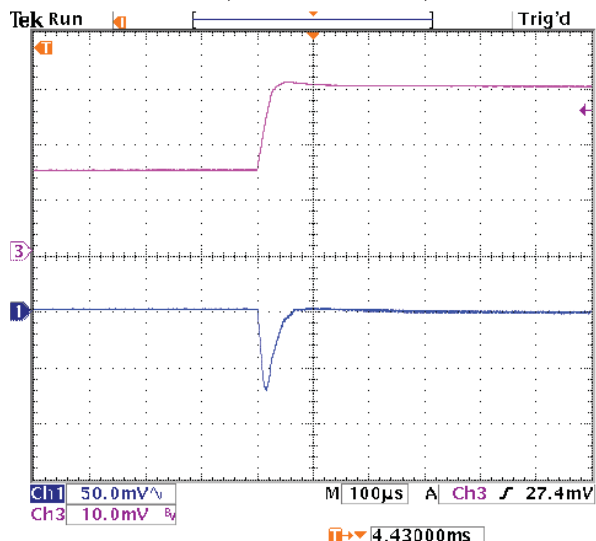

Step Load Transient Response (Vin=12V, Vout=3.3V, Cload=0, Iout=3A to 1.5A) Trace 1=Vout, 50 mV/div. Trace 3=Iout, 1A/div.

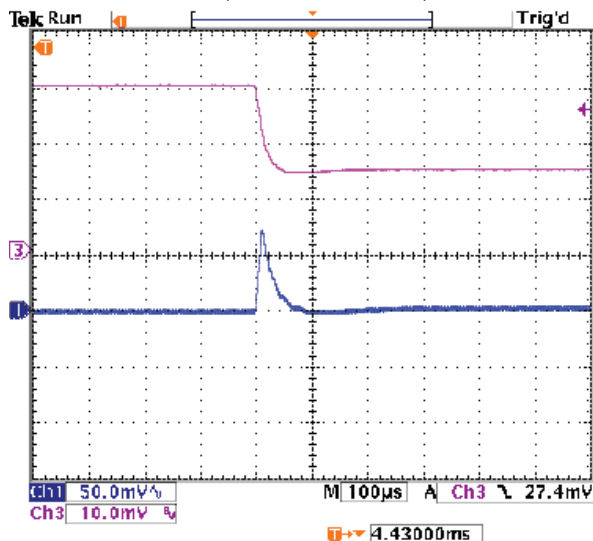

**OKY-T/3-D12 PERFORMANCE DATA: Vout = 5V**

OKY-T/3-D12 Efficiency vs. Line Voltage and Load Current @ 25°C (Vout = 5V)

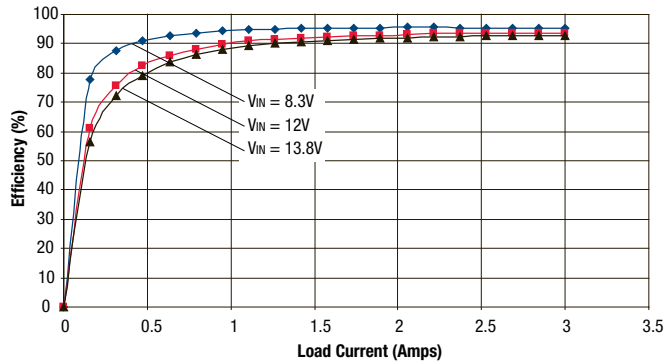

OKY-T/3-D12 Maximum Current Temperature Derating @ Sea Level (VIN = 12V, Vout = 5V, airflow is transverse)

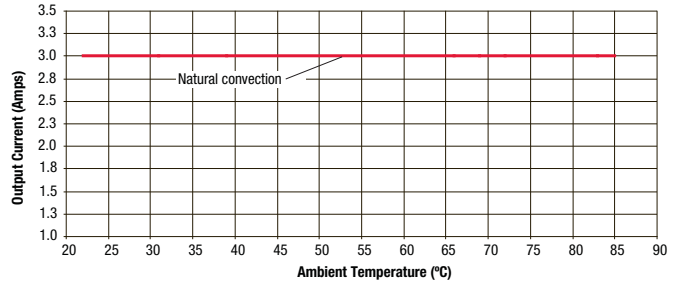

**OKY-T/3-D12 OSCILLOGRAMS: Vout = 5V**

Output Ripple and Noise (Vin=12V, Vout=5V, Iout=3A, Load=0, ScopeBW=100MHz)

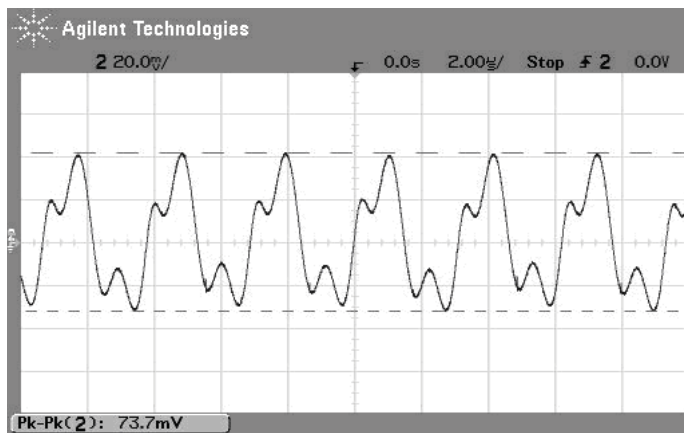

On/Off Enable Startup Delay (Vin=12V, Vout=5V, Iout=3A, Load=0) Trace 4=Enable In, Trace2=Vout

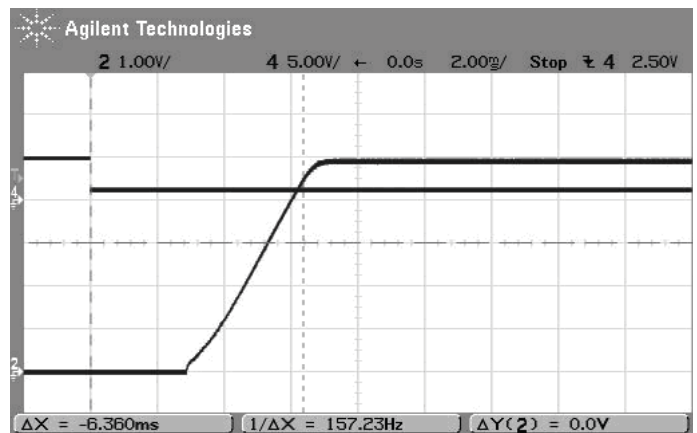

Step Load Transient Response (Vin=12V, Vout=5V, Load=0, Iout=1.5A to 3A) Trace 1=Vout, 50 mV/div. Trace 3=Iout, 1A/div.

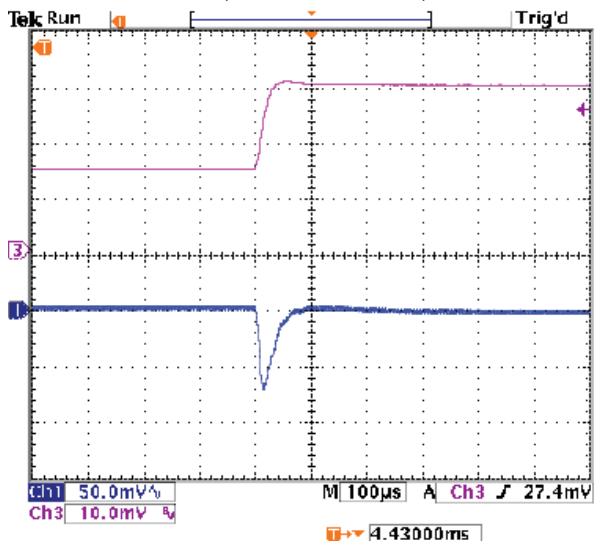

Step Load Transient Response (Vin=12V, Vout=5V, Load=0, Iout=3A to 1.5A) Trace 1=Vout, 50 mV/div. Trace 3=Iout, 1A/div.

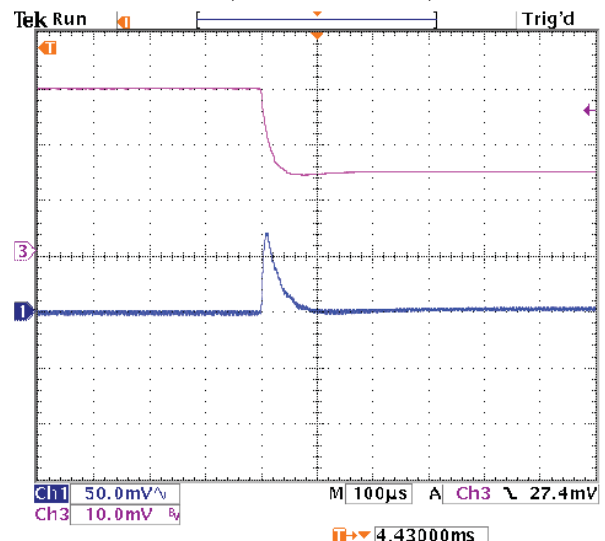



**OKY-T/5-D12 PERFORMANCE DATA: Vout = .75V**

OKY-T/5-D12 Maximum Current Temperature Derating @ Sea Level  
(VIN = 12V, VOUT = .75V, airflow is transverse)

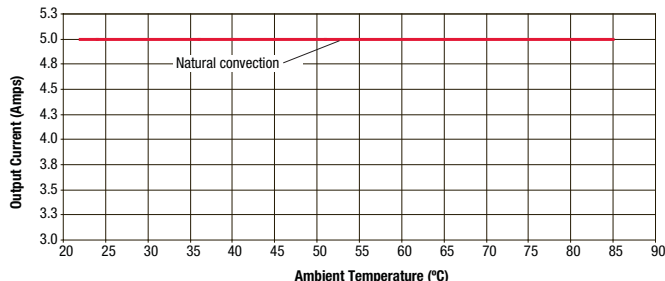

**OKY-T/5-D12 OSCILLOGRAMS: Vout = .75V**

Output Ripple and Noise  
(Vin=12V, Vout=0.75V, Iout=5A, Cload=0, ScopeBW=100MHz)

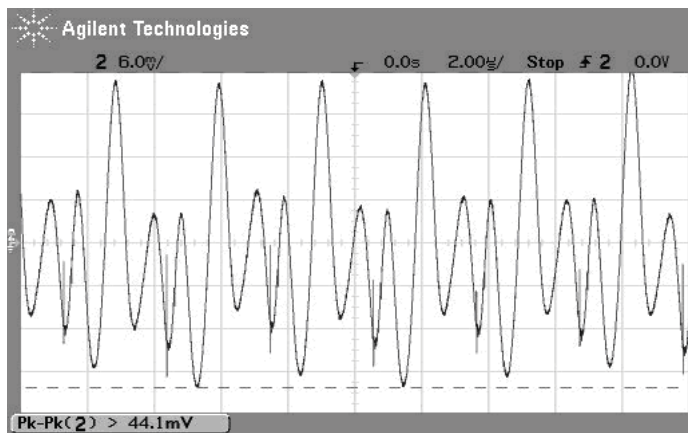

On/Off Enable Startup Delay (Vin=12V, Vout=0.75V, Iout=5A, Cload=0)  
Trace 4=Enable In, Trace2=Vout

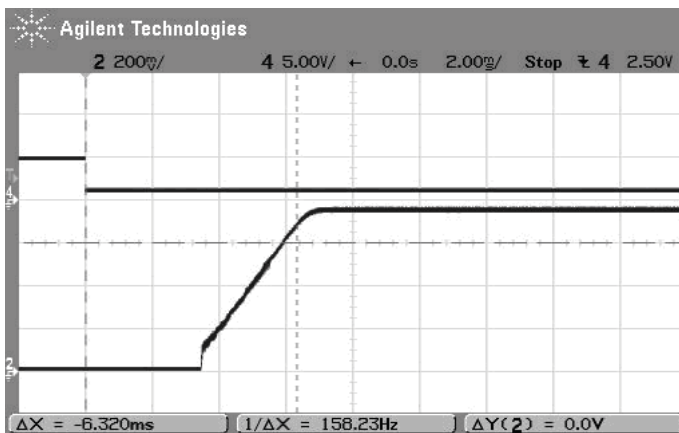

**OKY-T/5-D12 PERFORMANCE DATA: Vout = 1V**

OKY-T/5-D12 Efficiency vs. Line Voltage and Load Current @ 25°C (Vout = 1V)

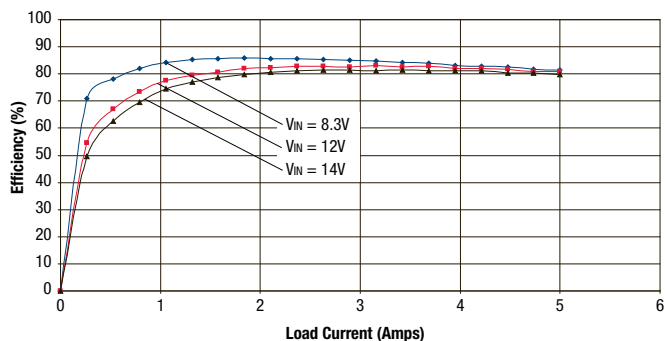

OKY-T/5-D12 Maximum Current Temperature Derating @ Sea Level  
(VIN = 12V, VOUT = 1V, airflow is transverse)

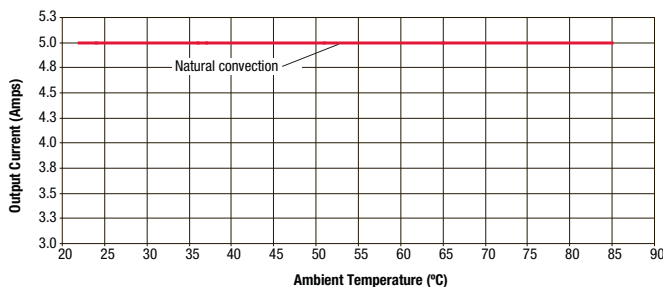

**OKY-T/5-D12 PERFORMANCE DATA: Vout = 1.2V**

OKY-T/5-D12 Efficiency vs. Line Voltage and Load Current @ 25°C (Vout = 1.2V)

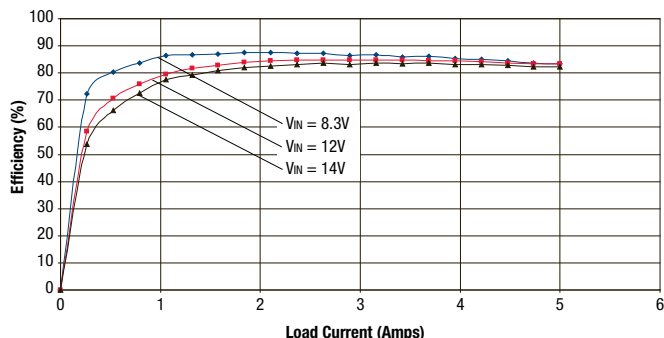

OKY-T/5-D12 Maximum Current Temperature Derating @ Sea Level (VIN = 12V, Vout = 1.2V, airflow is transverse)

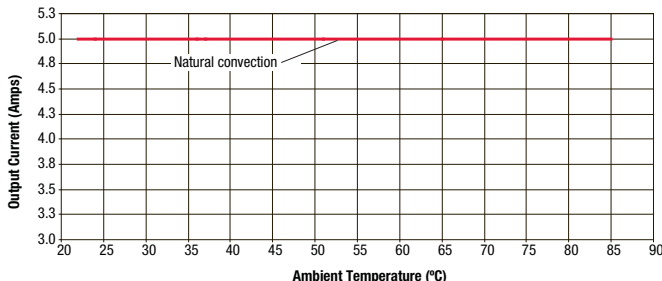

**OKY-T/5-D12 OSCILLOGRAMS: Vout = 1.2V**

Output Ripple and Noise (Vin=12V, Vout=1.2V, Iout=5A, Cload=0, ScopeBW=100MHz)

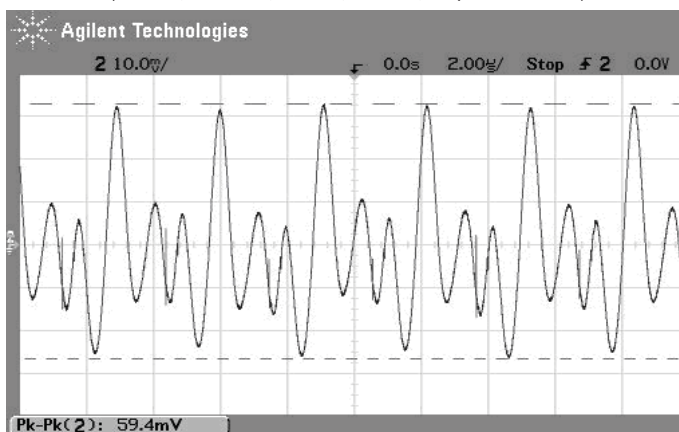

Step Load Transient Response (Vin=12V, Vout=1.2V, Cload=0, Iout=2.5A to 5A)  
Trace 1=Vout, 100 mV/div. Trace 3=Iout, 2A/div.

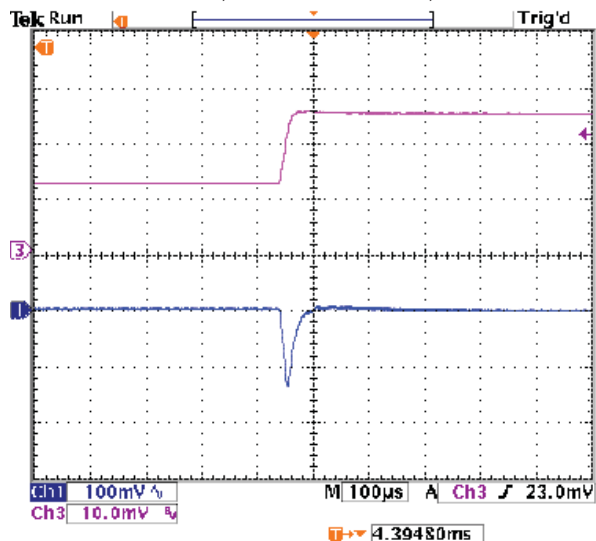

Step Load Transient Response (Vin=12V, Vout=1.2V, Cload=0, Iout=5A to 2.5A)  
Trace 1=Vout, 100 mV/div. Trace 3=Iout, 2A/div.

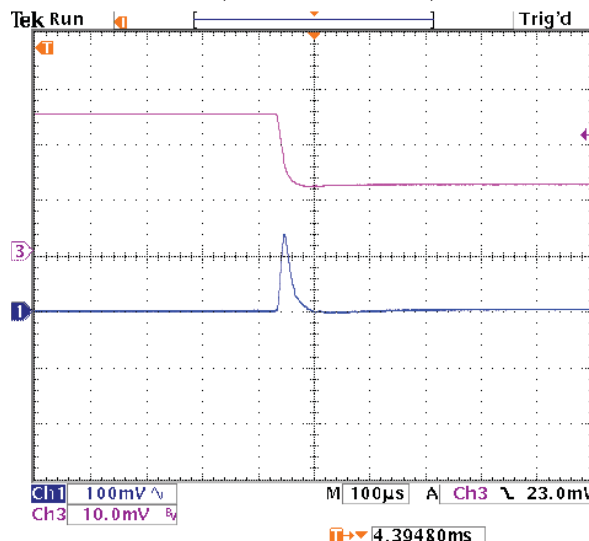

**OKY-T/5-D12 PERFORMANCE DATA:  $V_{out} = 1.5V$**

OKY-T/5-D12 Efficiency vs. Line Voltage and Load Current @ 25°C ( $V_{out} = 1.5V$ )

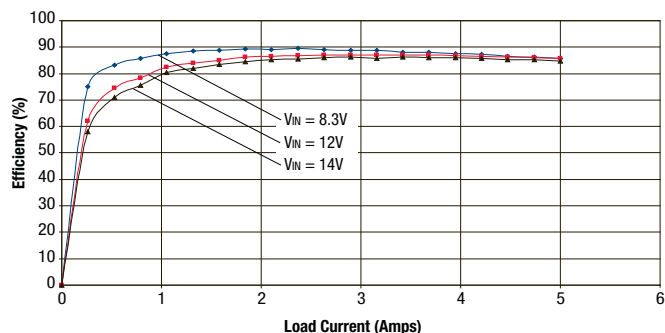

OKY-T/5-D12 Maximum Current Temperature Derating @ Sea Level ( $V_{in} = 12V, V_{out} = 1.5V$ , airflow is transverse)

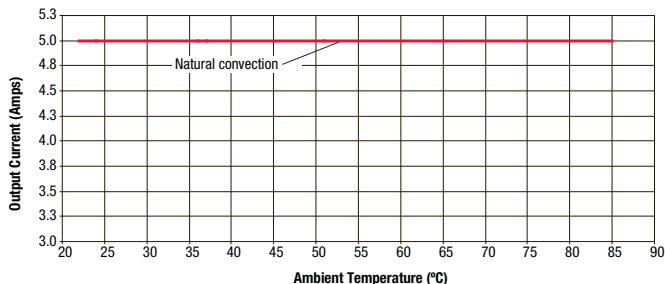

**OKY-T/5-D12 PERFORMANCE DATA:  $V_{out} = 1.8V$**

OKY-T/5-D12 Efficiency vs. Line Voltage and Load Current @ 25°C ( $V_{out} = 1.8V$ )

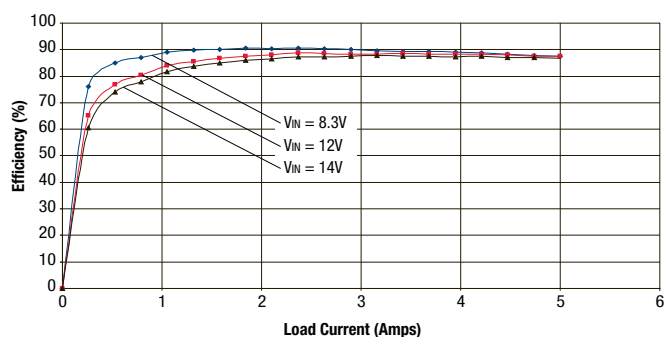

OKY-T/5-D12 Maximum Current Temperature Derating @ Sea Level ( $V_{in} = 12V, V_{out} = 1.8V$ , airflow is transverse)

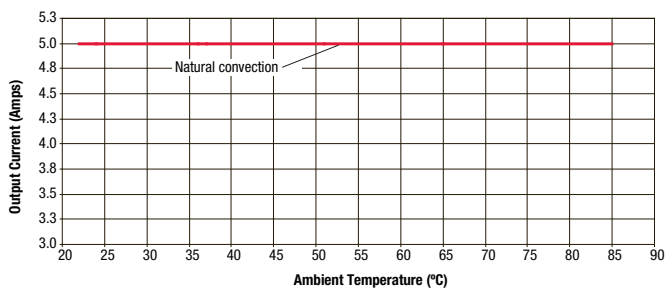

**OKY-T/5-D12 PERFORMANCE DATA: Vout = 2.5V**

OKY-T/5-D12 Efficiency vs. Line Voltage and Load Current @ 25°C (Vout = 2.5V)

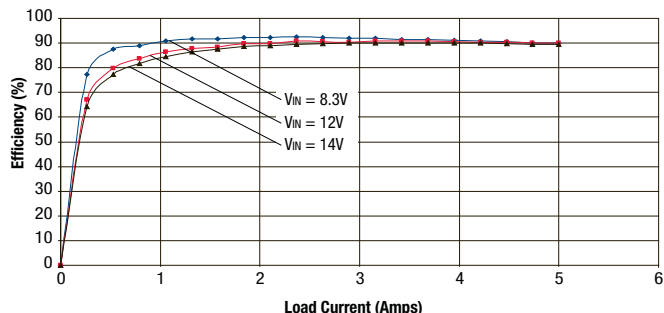

OKY-T/5-D12 Maximum Current Temperature Derating @ Sea Level (VIN = 12V, Vout = 2.5V, airflow is transverse)

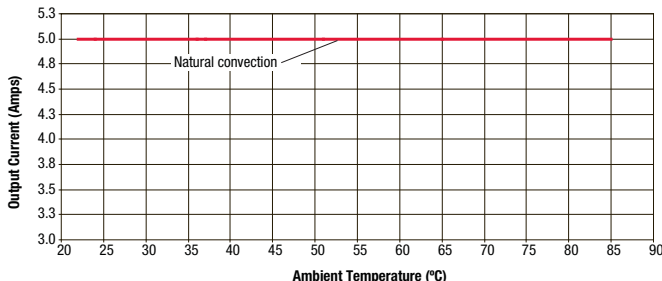

**OKY-T/5-D12 OSCILLOGRAMS: Vout = 2.5V**

Output Ripple and Noise (Vin=12V, Vout=2.5V, Iout=5A, Cload=0, ScopeBW=100MHz)

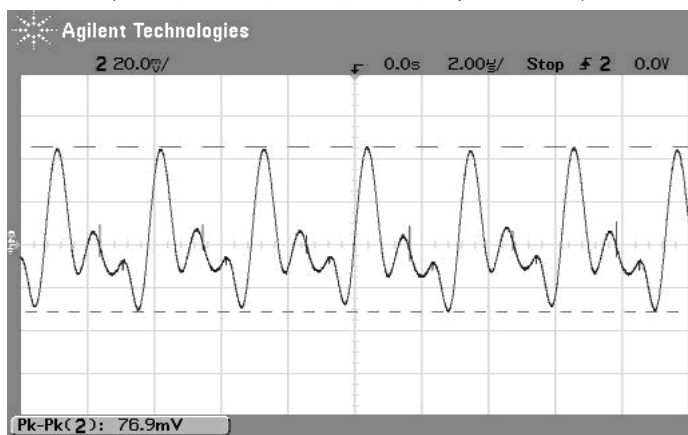

On/Off Enable Startup Delay (Vin=12V, Vout=2.5V, Iout=5A, Cload=0) Trace 4=Enable In, Trace 2=Vout

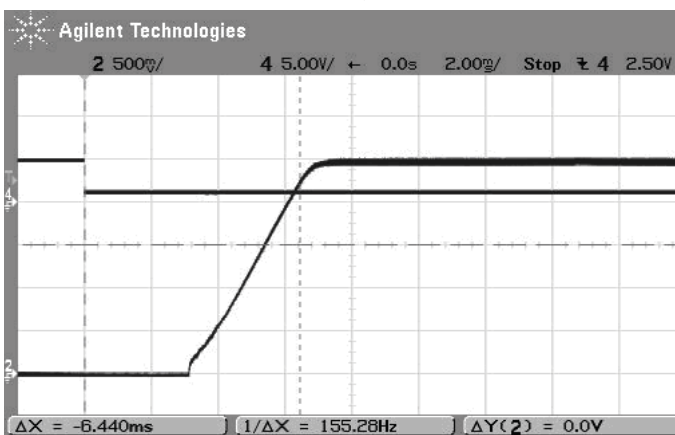

Step Load Transient Response (Vin=12V, Vout=2.5V, Cload=0, Iout=2.5A to 5A) Trace 1=Vout, 100 mV/div. Trace 3=Iout, 2A/div.

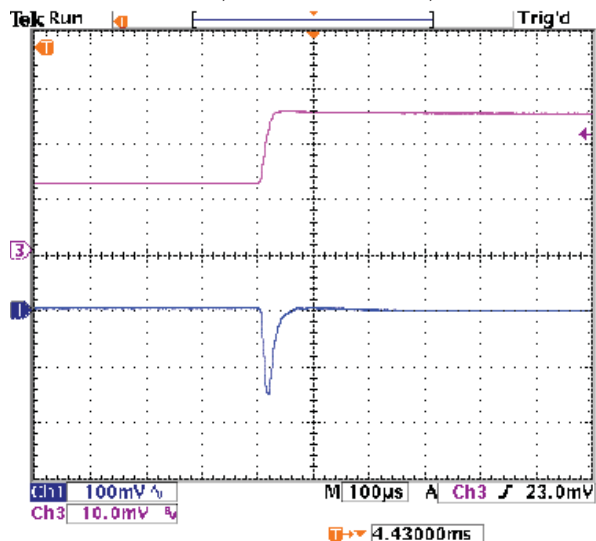

Step Load Transient Response (Vin=12V, Vout=2.5V, Cload=0, Iout=5A to 2.5A) Trace 1=Vout, 100 mV/div. Trace 3=Iout, 2A/div.

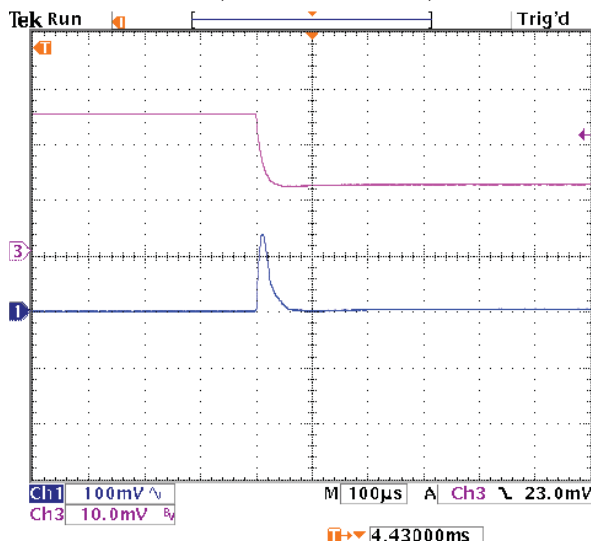

**OKY-T/5-D12 PERFORMANCE DATA: Vout = 3.3V**

OKY-T/5-D12 Efficiency vs. Line Voltage and Load Current @ 25°C (Vout = 3.3V)

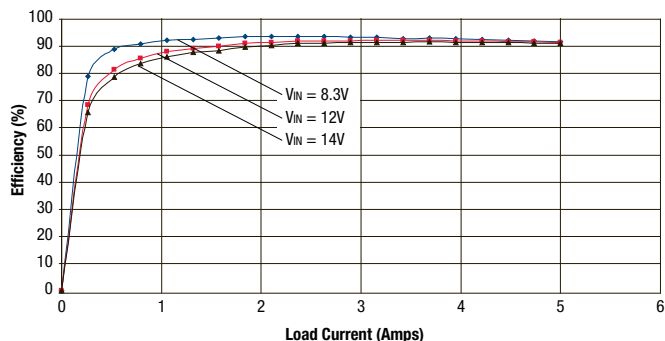

OKY-T/5-D12 Maximum Current Temperature Derating @ Sea Level (Vin = 12V, Vout = 3.3V, airflow is transverse)

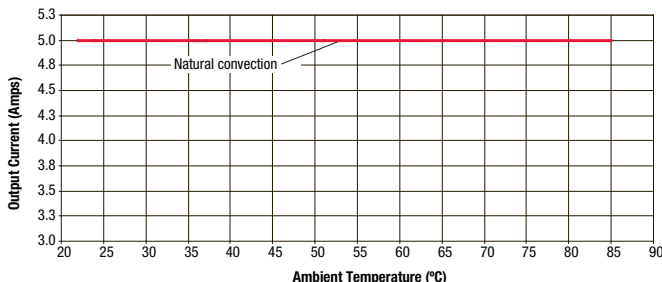

**OKY-T/5-D12 OSCILLOGRAMS: Vout = 3.3V**

Output Ripple and Noise (Vin=12V, Vout=3.3V, Iout=5A, Cload=0, ScopeBW=100MHz)

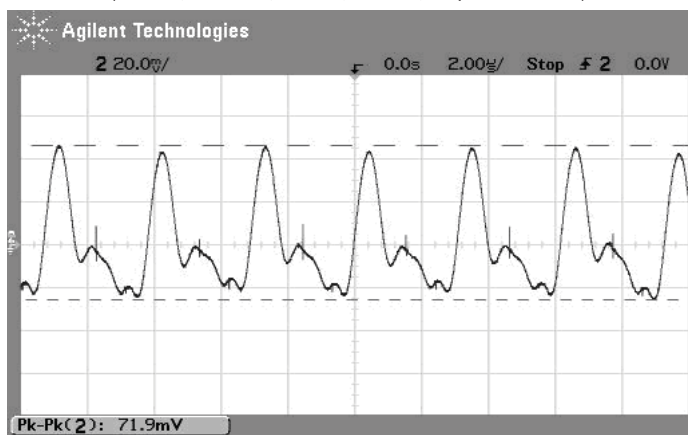

On/Off Enable Startup Delay (Vin=12V, Vout=3.3V, Iout=5A, Cload=0) Trace 4=Enable In, Trace 2=Vout

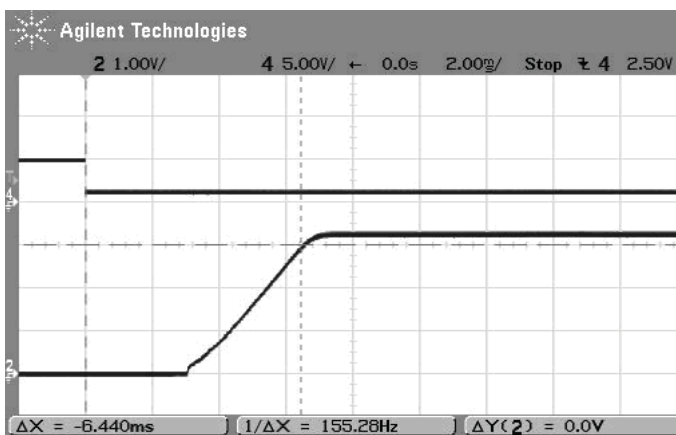

Step Load Transient Response (Vin=12V, Vout=3.3V, Cload=0, Iout=2.5A to 5A) Trace 1=Vout, 100 mV/div. Trace 3=Iout, 2A/div.

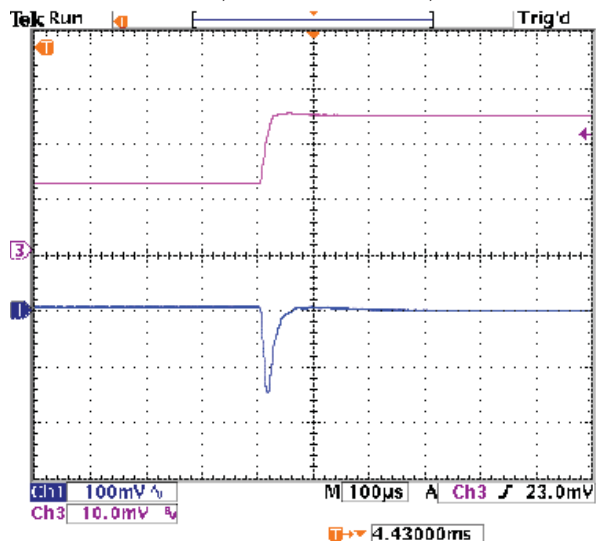

Step Load Transient Response (Vin=12V, Vout=3.3V, Cload=0, Iout=5A to 2.5A) Trace 1=Vout, 100 mV/div. Trace 3=Iout, 2A/div.

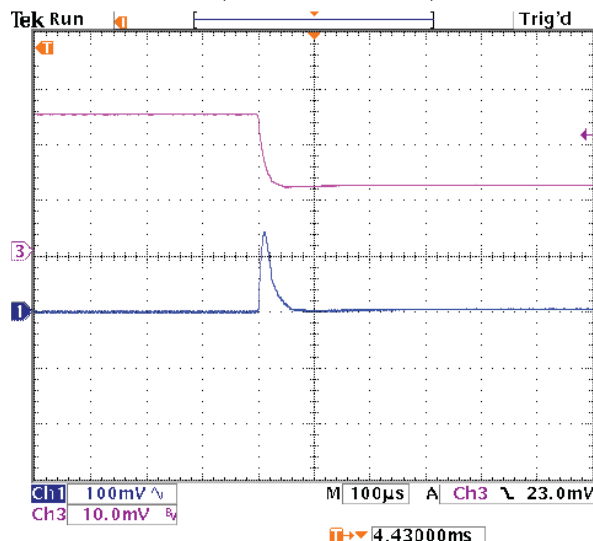

**OKY-T/5-D12 PERFORMANCE DATA: Vout = 5V**

OKY-T/5-D12 Efficiency vs. Line Voltage and Load Current @ 25°C (Vout = 5V)

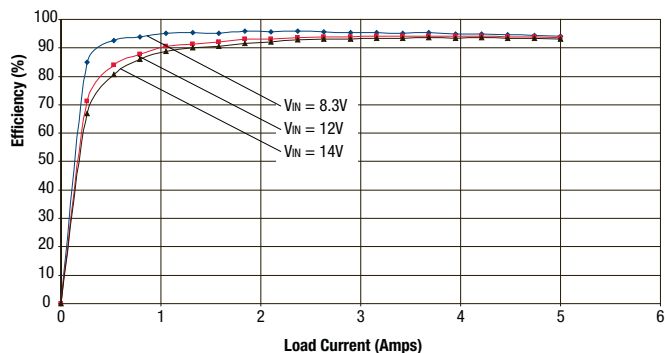

OKY-T/5-D12 Maximum Current Temperature Derating @ Sea Level (VIN = 12V, Vout = 5V, airflow is transverse)

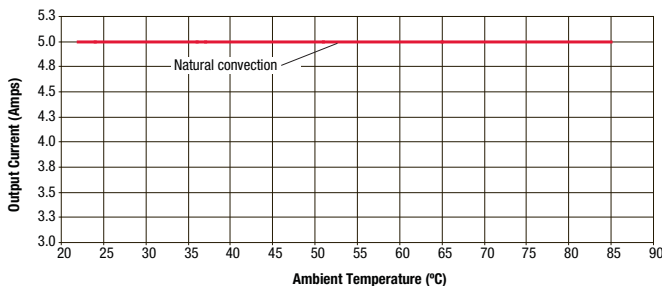

**OKY-T/5-D12 OSCILLOGRAMS: Vout = 5V**

Output Ripple and Noise (Vin=12V, Vout=5V, Iout=5A, Cload=0, ScopeBW=100MHz)

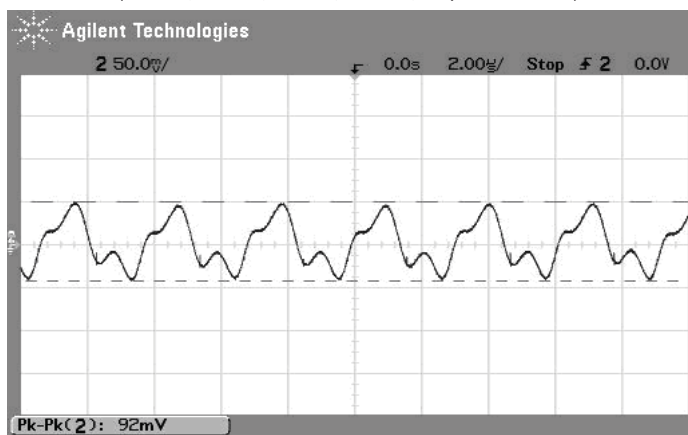

On/Off Enable Startup Delay (Vin=12V, Vout=5V, Iout=5A, Cload=0 Trace 4=Enable In, Trace2=Vout)

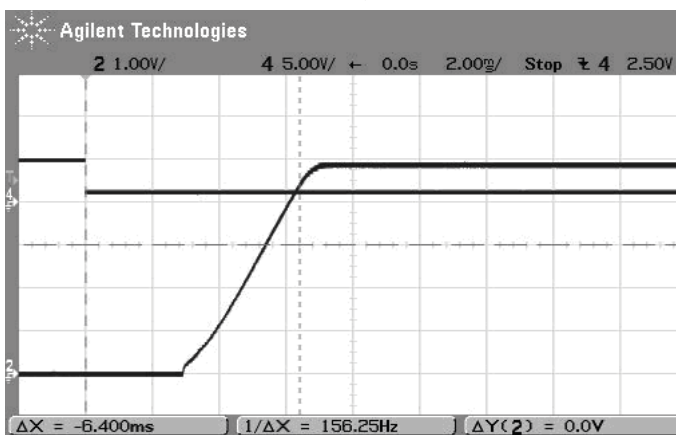

Step Load Transient Response (Vin=12V, Vout=5V, Cload=0, Iout=2.5A to 5A) Trace 1=Vout, 100 mV/div. Trace 3=Iout, 2A/div.

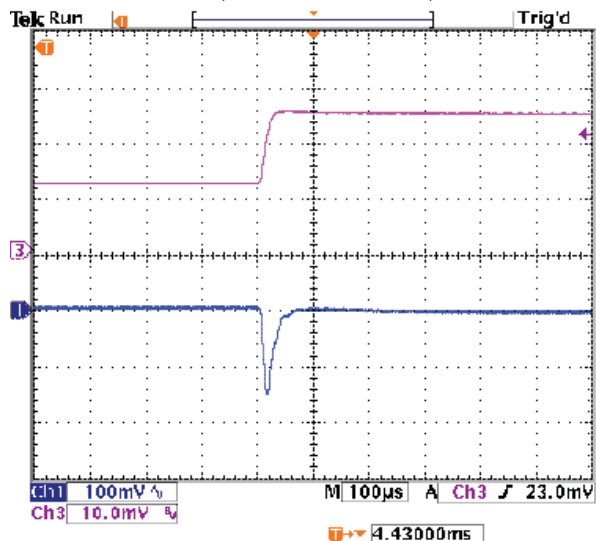

Step Load Transient Response (Vin=12V, Vout=5V, Cload=0, Iout=5A to 2.5A) Trace 1=Vout, 100 mV/div. Trace 3=Iout, 2A/div.

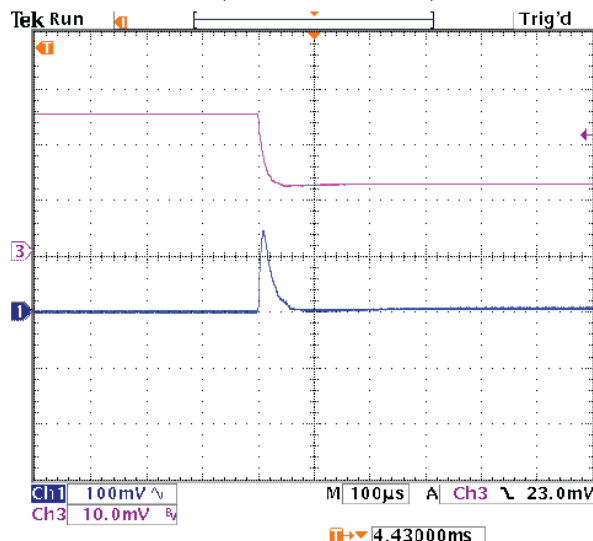



**TAPE AND REEL INFORMATION**

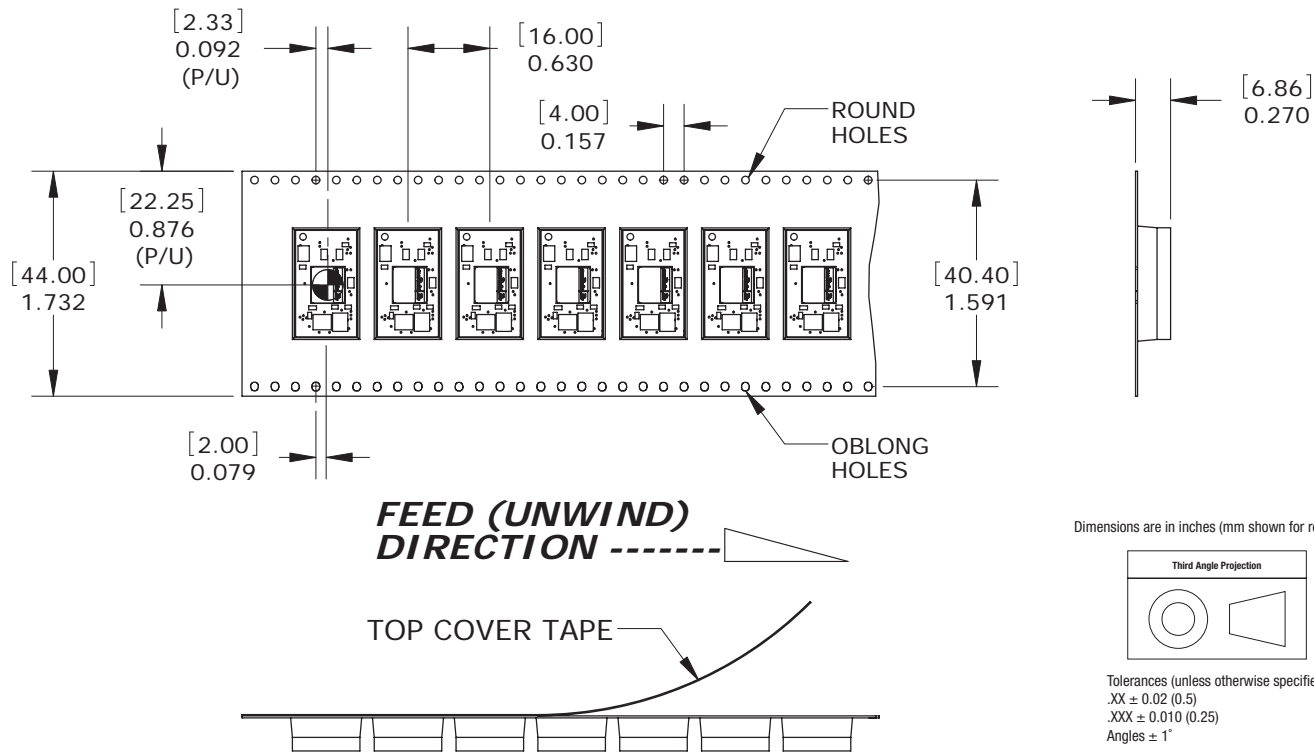

Dimensions are in inches (mm shown for ref. only).

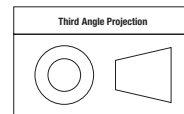

Tolerances (unless otherwise specified):  
 .XX ± 0.02 (0.5)  
 .XXX ± 0.010 (0.25)  
 Angles ± 1°

Components are shown for reference only.

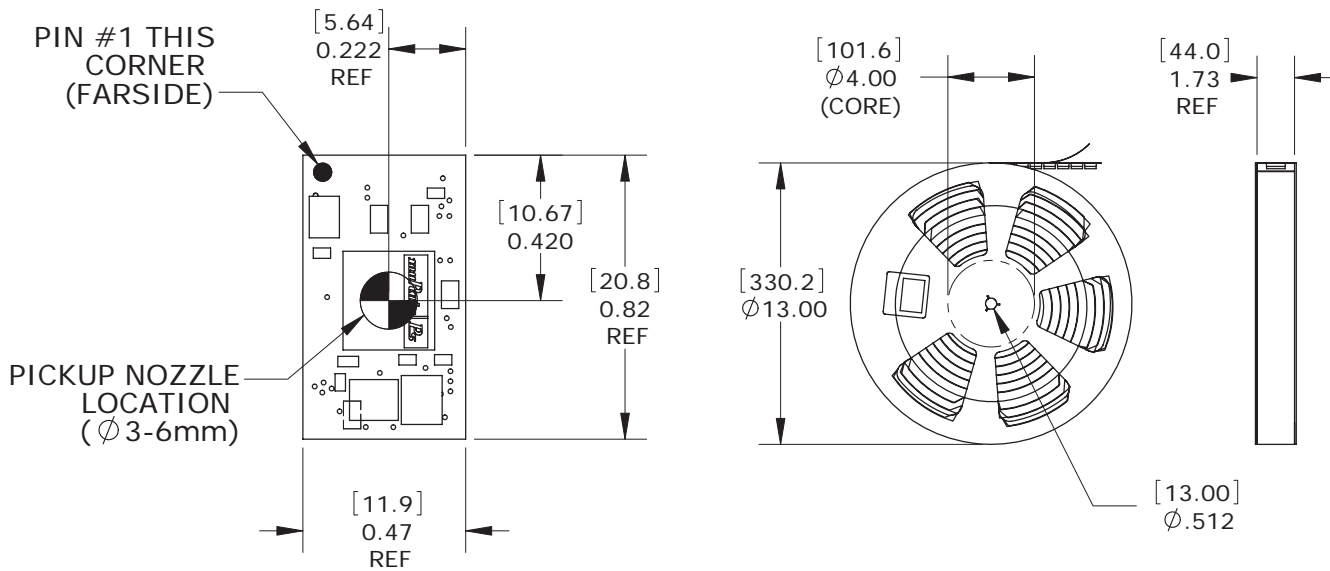

**PICK & PLACE PICKUP (P/U)**

**REEL INFORMATION (400 UNITS PER REEL)**

Murata Power Solutions, Inc.  
 11 Cabot Boulevard, Mansfield, MA 02048-1151 U.S.A.  
 ISO 9001 and 14001 REGISTERED



This product is subject to the following **operating requirements** and the **Life and Safety Critical Application Sales Policy**:  
 Refer to: <http://www.murata-ps.com/requirements/>

Murata Power Solutions, Inc. makes no representation that the use of its products in the circuits described herein, or the use of other technical information contained herein, will not infringe upon existing or future patent rights. The descriptions contained herein do not imply the granting of licenses to make, use, or sell equipment constructed in accordance therewith. Specifications are subject to change without notice. © 2012 Murata Power Solutions, Inc.



Компания «ЭлектроПласт» предлагает заключение долгосрочных отношений при поставках импортных электронных компонентов на взаимовыгодных условиях!

Наши преимущества:

- Оперативные поставки широкого спектра электронных компонентов отечественного и импортного производства напрямую от производителей и с крупнейших мировых складов;
- Поставка более 17-ти миллионов наименований электронных компонентов;
- Поставка сложных, дефицитных, либо снятых с производства позиций;
- Оперативные сроки поставки под заказ (от 5 рабочих дней);
- Экспресс доставка в любую точку России;
- Техническая поддержка проекта, помощь в подборе аналогов, поставка прототипов;
- Система менеджмента качества сертифицирована по Международному стандарту ISO 9001;
- Лицензия ФСБ на осуществление работ с использованием сведений, составляющих государственную тайну;
- Поставка специализированных компонентов (Xilinx, Altera, Analog Devices, Intersil, Interpoint, Microsemi, Aeroflex, Peregrine, Syfer, Eurofarad, Texas Instrument, Miteq, Cobham, E2V, MA-COM, Hittite, Mini-Circuits, General Dynamics и др.);

Помимо этого, одним из направлений компании «ЭлектроПласт» является направление «Источники питания». Мы предлагаем Вам помощь Конструкторского отдела:

- Подбор оптимального решения, техническое обоснование при выборе компонента;
- Подбор аналогов;
- Консультации по применению компонента;
- Поставка образцов и прототипов;
- Техническая поддержка проекта;
- Защита от снятия компонента с производства.



#### Как с нами связаться

**Телефон:** 8 (812) 309 58 32 (многоканальный)

**Факс:** 8 (812) 320-02-42

**Электронная почта:** [org@eplast1.ru](mailto:org@eplast1.ru)

**Адрес:** 198099, г. Санкт-Петербург, ул. Калинина, дом 2, корпус 4, литера А.