

ULTRA MINIATURE RELAY SIGNAL RELAY

FTR-C1 Series

RoHS compliant

■ FEATURES

- Dimensions of large contact gap relay
 Height: 9.3 mm maximum (THT)
 9.65 mm maximum (SMT)
 Length: 15 mm maximum
 Width: 7.5 mm maximum
- Conforms to IEC60950 / EN60950 / UL1950/ C22.2
 No.950 spacing & high breakdown voltage
 Clearance: 2.0 mm (coil and contacts)
 Creepage: 2.5 mm (coil and contacts)
- HIGH RELIABILITY
 Bifurcated contacts
- Low power consumption 280 mW (latching type
 140mW)
- RoHS Compliant since beginning of production

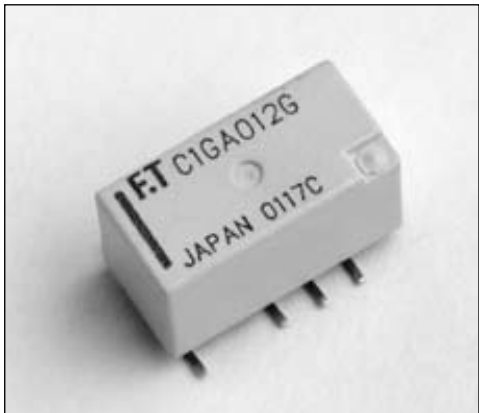

■ ORDERING INFORMATION

[Example] FTR-C1 C A 012 G-(B05)*
 (a) (b) (c) (d) (e) (f)

(a)	Series Name	FTR-C1
(b)	Terminal Appearance	C: Through hole type G: Surface mount type
(c)	Operation Function	A: Standard Type B: Single coil latching type
(d)	Coil Number	Nominal Voltage
(e)	Contact Material	G: Silver alloy

Remarks: Actual marking on relay would not carry code FTR and be as below:

Ordering code Actual marking
FTR-C1CA03G → **C1CA03G**

* If ordering tape and reel package, please add "B05" after the partnumber (tape and reel is only available for SMT type, example: FTR-C1GA003G-B05)

FTR-C1 Series

■ COIL DATA CHART

Standard type

Model		Nominal Voltage	Coil Resistance ($\pm 10\%$)	Must Operate Voltage	Must Release Voltage	Nominal Operating Power ($\pm 10\%$)
THT	SMT					
FTR-C1CA003G	FTR-C1GA003G	3 VDC	32.1 Ω	2.25 VDC	0.3 VDC	280 mW
FTR-C1CA4.5G	FTR-C1GA4.5G	4.5 VDC	72.3 Ω	3.38 VDC	0.45 VDC	280 mW
FTR-C1CA005G	FTR-C1GA005G	5 VDC	89.3 Ω	3.75 VDC	0.5 VDC	280 mW
FTR-C1CA012G	FTR-C1GA012G	12VDC	514 Ω	9.00 VDC	1.2 VDC	280 mW
FTR-C1CA024G	FTR-C1GA024G	24VDC	1920 Ω	18.0 VDC	2.4 VDC	300 mW

Note: All values in the table are measured at 20°C.

Single coil latching type

Model		Nominal Voltage	Coil Resistance ($\pm 10\%$)	Set Voltage	Reset Voltage	Nominal Operating Power ($\pm 10\%$)
THT	SMT					
FTR-C1CB003G	FTR-C1GB003G	3 VDC	64 Ω	2.25 VDC	2.25 VDC	140 mW
FTR-C1CB4.5G	FTR-C1GB4.5G	4.5 VDC	145 Ω	3.38 VDC	3.38 VDC	140 mW
FTR-C1CB005G	FTR-C1GB005G	5 VDC	179 Ω	3.75 VDC	3.75 VDC	140 mW
FTR-C1CB012G	FTR-C1GB012G	12VDC	1029 Ω	9.00 VDC	9.00 VDC	140 mW
FTR-C1CB024G	FTR-C1GB024G	24VDC	3200 Ω	18.0 VDC	18.0 VDC	180 mW

Note: - All values in the table are measured at 20°C.
 - Single coil latching type is applying to the standard now.

FTR-C1 Series

■ SPECIFICATIONS

Item		FTR-C1CA ()G FTR-C1GA ()G	
Contact	Arrangement	2 Form C	
	Material	Silver alloy	
	Resistance (initial)	Max. 100m ohm (at 1A 6VDC)	
	Max. Switching Power	37.5AV / 30W	
	Max. Switching Voltage	250VAC, 220 VDC	
	Max. Switching Current	1 A	
Coil	Operating Temperature	-40° C to + 85° C (no frost)	
	Max. Allowable Voltage	150% nominal voltage (at 20° C)	
Time Value	Operate Time	Max. 10ms (at nominal voltage, without bounce)	
	Release Time (without diode)	Max. 10ms (at nominal voltage, without bounce)	
Insulation	Resistance (at 500 VDC)		Min. 1,000M ohm S
	Dielectric Strength	Between open contacts	1,500VAC, 1 minute
		Between adjacent contacts	1,500VAC, 1 minute
		Between coil and contacts	3,000VAC, 1 minute
	Surge Strength	Between open contacts	2,500V (at 2/10 microsec)
		Between adjacent contacts	2,500V (at 2/10 microsec)
Between coil and contacts		5,000V (at 2/10 microsec)	
Life	Mechanical	10x10 ⁶ operations min. (at 10Hz)	
	Electrical (resistive load)	100x10 ³ operations min. at 1A, 30VDC, 0.5Hz 100x10 ³ operations min. at 0.1A, 48VDC, 0.5Hz 100x10 ³ operations min. at 0.3A, 125VDC, 0.5Hz	
Vibration Resistance	Misoperation	10 to 55 Hz at double amplitude of 3.3 mm	
	Endurance	10 to 55 Hz at double amplitude of 5 mm	
Shock Resistance	Misoperation	Min. 500 m/s ²	
	Endurance	Min. 1,000 m/ s ²	
UL / CSA	Contact Rating	0.3A 125 VAC 1A 30VDC 0.3 110VDC	
IEC060950 UL1950 C22.2 No.950 EN60950	Insulation Class	Supplementary Insulation	
	Working Voltage	250 V	
	Pollution Degree	2	
	Clearance	2.0 mm (between coil and contacts)	
	Creepage Distance	2.5 mm (between coil and contacts)	

■ DIMENSIONS AND SCHEMATICS

Through hole type

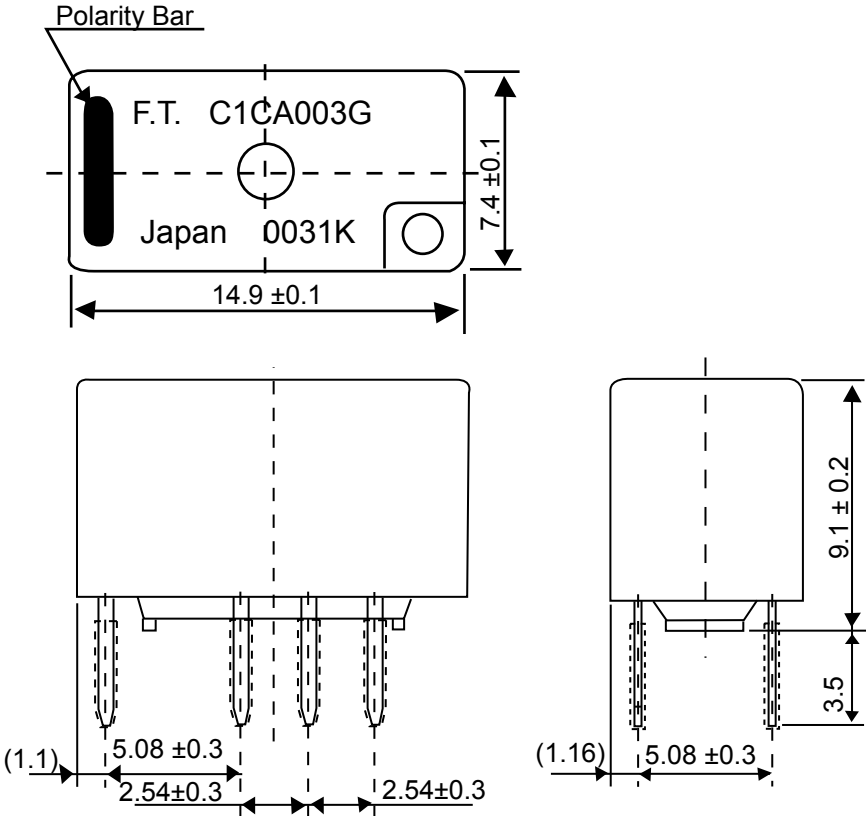

Unit: mm

■ TERMINAL DESIGNATIONS

Standard type
(Bottom view de-energized position)

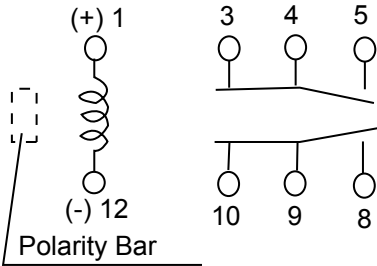

Single Coil Latching type
(Bottom view reset position)

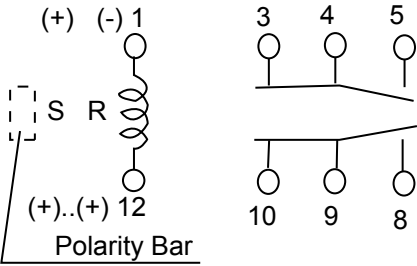

■ RECOMMENDED MOUNTING PAD

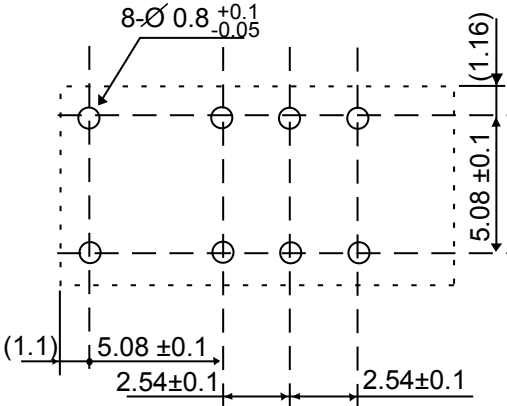

S shows the polarity of set position
R shows the polarity of reset position

Unit: mm

FTR-C1 Series

■ DIMENSIONS AND SCHEMATICS

Surface mount type

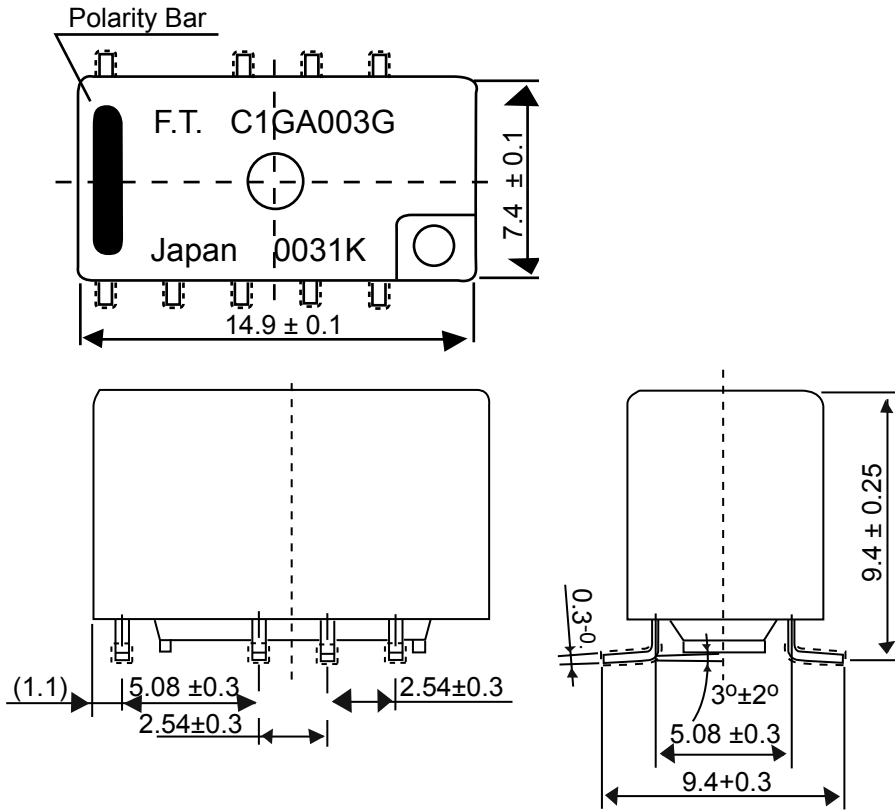

Unit: mm

■ TERMINAL DESIGNATIONS

Standard type

(Top view de-energized position)

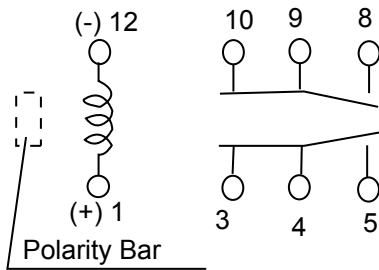

Single Coil Latching type

(Bottom view reset position)

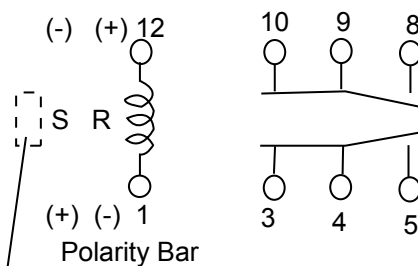

■ RECOMMENDED MOUNTING PAD

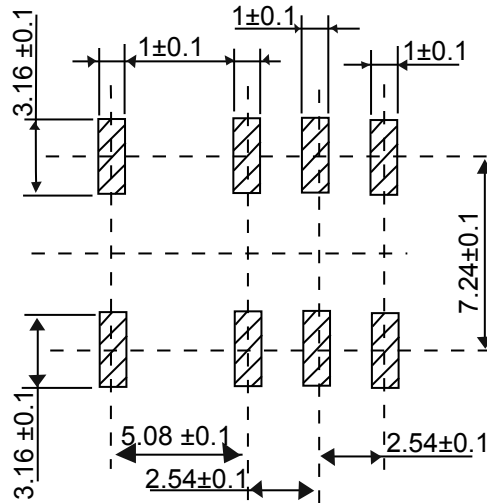

S shows the polarity of set position
R shows the polarity of reset position

Unit: mm

FTR-C1 Series

RECOMMENDED SOLDERING CONDITIONS (TEMPERATURE PROFILE)

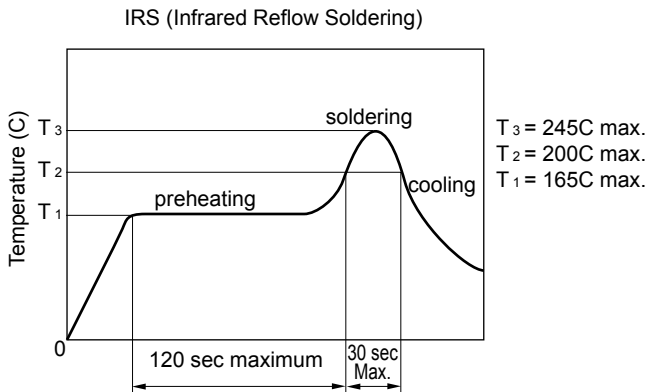

- Note:
1. Temperature profiles show the temperature of PC board surface.
 2. Please perform soldering test with your actual PC board before mass production, since the temperatures of PC board surfaces vary according to the size of PC board, status of parts mounting and heating method.

PACKAGING

Packaging method (only tape packaging is available)

1. Taping standards: JIS C 0806 and RC-10092B (EIAJ)
2. Reel type: TB2416 or TB2416
3. Reel type: RD24D
4. Quantity of 1 reel: 500 pieces

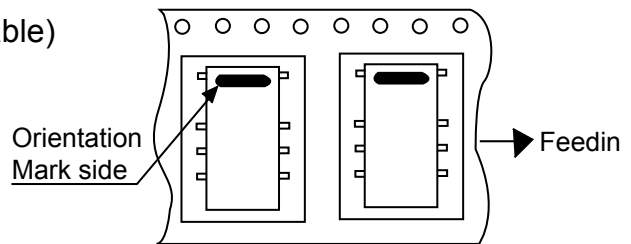

Tape Dimensions:

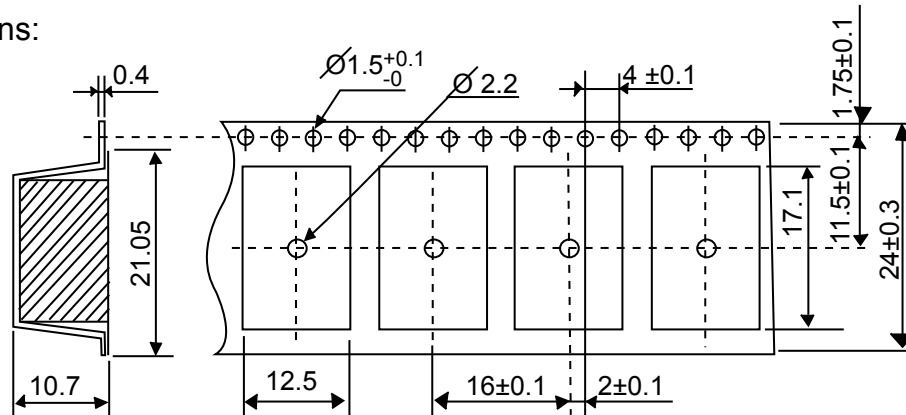

Reel Dimensions:

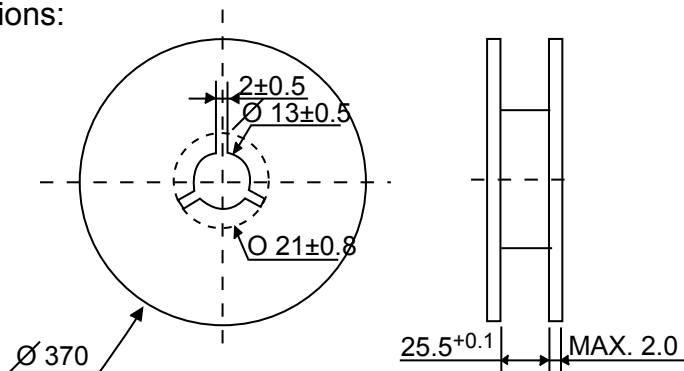

Unit: mm

RoHS Compliance and Lead Free Relay Information

1. General Information

- Relays produced after the specific date code that is indicated on each data sheet are lead-free now. Most of our signal and power relays are lead-free. Please refer to Lead-Free Status Info. (<http://www.fujitsu.com/us/downloads/MICRO/fcai/relays/lead-free-letter.pdf>)
- Lead free solder paste currently used in relays is Sn-3.0Ag-0.5Cu.
- All signal and most power relays also comply with RoHS. Please refer to individual data sheets. Relays that are RoHS compliant do not contain the 5 hazardous materials that are restricted by RoHS directive (lead, mercury, chromium IV, PBB, PBDE).
- It has been verified that using lead-free relays in leaded assembly process will not cause any problems (compatible).
- "LF" is marked on each outer and inner carton. (No marking on individual relays).
- To avoid leaded relays (for lead-free sample, etc.) please consult with area sales office.
- We will ship leaded relays as long as the leaded relay inventory exists.

Note: Cadmium was exempted from RoHS on October 21, 2005. (Amendment to Directive 2002/95/EC)

2. Recommended Lead Free Solder Profile

- Recommended solder paste Sn-3.0Ag-0.5Cu and Sn-3.0 Cu-Ni (only FTR-B3 and FTR-B4 from February 2005).

Reflow Solder condition for SMT

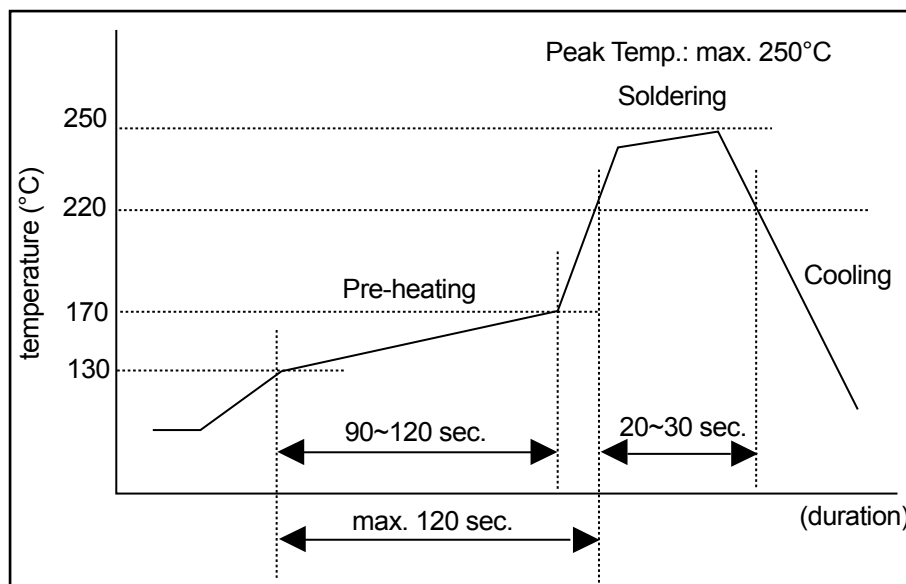

Flow Solder condition:

Pre-heating: maximum 120°C
Soldering: dip within 5 sec. at 260°C solder bath

Solder by Soldering Iron:

Soldering Iron
Temperature: maximum 360°C
Duration: maximum 3 sec.

We highly recommend that you confirm your actual solder conditions

3. Moisture Sensitivity

- Moisture Sensitivity Level standard is not applicable to electromechanical relays.

4. Tin Whisker

- SnAgCu and SnCuNi solder is known as low risk of tin whisker. No considerable length whisker was found by our in-house test.

Fujitsu Components International Headquarter Offices

Japan

Fujitsu Component Limited
Gotanda-Chuo Building
3-5, Higashigotanda 2-chome, Shinagawa-ku
Tokyo 141, Japan
Tel: (81-3) 5449-7010
Fax: (81-3) 5449-2626
Email: promothq@ft.ed.fujitsu.com
Web: www.fcl.fujitsu.com

North and South America

Fujitsu Components America, Inc.
250 E. Caribbean Drive
Sunnyvale, CA 94089 U.S.A.
Tel: (1-408) 745-4900
Fax: (1-408) 745-4970
Email: components@us.fujitsu.com
Web: <http://us.fujitsu.com/components/>

Europe

Fujitsu Components Europe B.V.
Diamantlaan 25
2132 WV Hoofddorp
Netherlands
Tel: (31-23) 5560910
Fax: (31-23) 5560950
Email: info@fceu.fujitsu.com
Web: <http://www.fujitsu.com/emea/services/components/>

Asia Pacific

Fujitsu Components Asia Ltd.
102E Pasir Panjang Road
#04-01 Citilink Warehouse Complex
Singapore 118529
Tel: (65) 6375-8560
Fax: (65) 6273-3021
Email: fcal@fcal.fujitsu.com
Web: <http://www.fujitsu.com/sg/services/micro/components/>

©2007 Fujitsu Components America, Inc. All rights reserved. All trademarks or registered trademarks are the property of their respective owners.

Fujitsu Components America does not warrant that the content of datasheet is error free. In a continuing effort to improve our products Fujitsu Components America, Inc. reserves the right to change specifications/datasheets without prior notice. Rev. April 13, 2007



Компания «ЭлектроПласт» предлагает заключение долгосрочных отношений при поставках импортных электронных компонентов на взаимовыгодных условиях!

Наши преимущества:

- Оперативные поставки широкого спектра электронных компонентов отечественного и импортного производства напрямую от производителей и с крупнейших мировых складов;
- Поставка более 17-ти миллионов наименований электронных компонентов;
- Поставка сложных, дефицитных, либо снятых с производства позиций;
- Оперативные сроки поставки под заказ (от 5 рабочих дней);
- Экспресс доставка в любую точку России;
- Техническая поддержка проекта, помощь в подборе аналогов, поставка прототипов;
- Система менеджмента качества сертифицирована по Международному стандарту ISO 9001;
- Лицензия ФСБ на осуществление работ с использованием сведений, составляющих государственную тайну;
- Поставка специализированных компонентов (Xilinx, Altera, Analog Devices, Intersil, Interpoint, Microsemi, Aeroflex, Peregrine, Syfer, Eurofarad, Texas Instrument, Miteq, Cobham, E2V, MA-COM, Hittite, Mini-Circuits, General Dynamics и др.);

Помимо этого, одним из направлений компании «ЭлектроПласт» является направление «Источники питания». Мы предлагаем Вам помощь Конструкторского отдела:

- Подбор оптимального решения, техническое обоснование при выборе компонента;
- Подбор аналогов;
- Консультации по применению компонента;
- Поставка образцов и прототипов;
- Техническая поддержка проекта;
- Защита от снятия компонента с производства.



Как с нами связаться

Телефон: 8 (812) 309 58 32 (многоканальный)

Факс: 8 (812) 320-02-42

Электронная почта: org@eplast1.ru

Адрес: 198099, г. Санкт-Петербург, ул. Калинина, дом 2, корпус 4, литера А.