



## Features

- Conductive plastic
- PC board and bushing mount
- Plastic or metal bushing and plastic shaft
- Withstands typical industrial washing processes
- Compact package saves board and panel space



# 3310 - 9 mm Square Sealed Panel Control

### Electrical Characteristics

Standard Resistance Range - Linear .....	1 K ohms to 1 megohm
Total Resistance Tolerance - Linear Tapers .....	±20 %
Independent Linearity .....	±5 %
Absolute Minimum Resistance .....	2 ohms maximum
Effective Electrical Angle .....	270 ° ±15 °
Contact Resistance Variation .....	1 % or 1 ohm (whichever is greater)
Dielectric Withstanding Voltage (MIL-STD-202 – Method 301)	
Sea Level .....	900 VAC minimum
70,000 Feet .....	350 VAC minimum
Insulation Resistance .....	1,000 megohms minimum
Power Rating @ 70 °C (Derate to 0 at 125 °C - Voltage Limited By Power Dissipation or 200 VAC, Whichever is Less) .....	0.25 watts
Theoretical Resolution .....	Essentially infinite

### Environmental Characteristics

Operating Temperature Range .....	-40 °C to +125 °C (-40 °F to +257 °F)
Storage Temperature Range .....	-55 °C to +125 °C (-67 °F to +257 °F)
Temperature Coefficient Over Storage Temperature Range .....	±1,000 ppm/°C
Vibration .....	30 G
Total Resistance Shift .....	±1 % maximum
Voltage Ratio Shift .....	±1 % maximum
Shock .....	100 G
Total Resistance Shift .....	±1 % maximum
Voltage Ratio Shift .....	±1 % maximum
Load Life .....	1,000 hours
Total Resistance Shift .....	±10 % TRS maximum
Rotational Life (No Load) .....	50,000 cycles
Total Resistance Shift .....	±5 % TRS maximum
Contact Resistance Variation .....	3 % or 3 ohms, whichever is greater
Moisture Resistance .....	MIL-STD-202, Method 103, Condition B
Total Resistance Shift .....	±10 % TRS maximum
IP Rating .....	IP67

### Mechanical Characteristics

Stop Strength .....	5.65 N-cm (8 oz.-in.)
Mechanical Angle .....	300 ° nominal
Torque	
Starting .....	3.53 N-cm (5.0 oz.-in.) maximum
Running .....	3.53 N-cm (5.0 oz.-in.) maximum
Mounting (Torque on Bushing) .....	45 N-cm (4.0 lb.-in.) max [plastic bushing]; 79 N-cm (7.0 lb.-in.) max [metal bushing]
Weight (Single Section) .....	4.5 grams
(Each Additional Section) .....	2.5 grams
Terminals .....	Solderable pins
Soldering Condition	
Manual Soldering .....	96.5Sn/3.0Ag/0.5Cu solid wire or no-clean rosin cored wire; 370 °C (700 °F) max. for 3 seconds
Wave Soldering .....	96.5Sn/3.0Ag/0.5Cu solder with no-clean flux; 260 °C (500 °F) max. for 5 seconds
Wash Processes .....	For recommended wash processes, please refer to <a href="http://www.bourns.com/pdfs/sldclen.pdf">http://www.bourns.com/pdfs/sldclen.pdf</a>
Marking .....	Manufacturer's trademark, model number, product code, terminal style, resistance code and date code
Ganging .....	2 cups maximum
Hardware .....	One lockwasher and one mounting nut is shipped with each potentiometer, except where noted in the part number.
Flammability .....	Conforms to UL94V-0
Epoxy .....	Conforms to UL 94V-1
IP Rating .....	IP67

### Switch Characteristics

Switch Life .....	10K cycles
Contact Resistance .....	2 ohms max.
Dielectric Strength .....	350 VDC
Detent Torque .....	0.5 oz-in min.
Power Rating (Resistive Load) .....	100 mA @ 16 VDC

## Additional Features

- Audio taper versions available as special order
- RoHS compliant\*

# 3310 - 9 mm Square Sealed Panel Control

**BOURNS®**

### Standard Resistance Table

Resistance (Ohms)	Resistance Code
<b>1,000</b>	<b>102</b>
<b>2,000</b>	<b>202</b>
<b>5,000</b>	<b>502</b>
<b>10,000</b>	<b>103</b>
<b>20,000</b>	<b>203</b>
50,000	503
100,000	104
200,000	204
500,000	504
1,000,000	105

Popular values listed in boldface. Consult factory for special resistances.

### How To Order

**3310 Y - 0 0 1 - 103 L**

Model Number Designator \_\_\_\_\_  
 3310 = 9 mm Panel Control

Terminal Style Designator \_\_\_\_\_  
 Single Cup:  
 C = In-line Straight Terminals Side Exit 2.54 mm centers  
 R = In-line Terminals Rear Exit 2.54 mm centers  
 P = 5.08 mm x 2.54 mm Triangular Pattern Rear Exit  
 Y = 5.08 mm x 5.08 mm Triangular Pattern Rear Exit

Dual Cup (Pot/Pot or Pot/Switch):  
 H = Dual In-line Straight Terminals Rear Exit 2.54 mm centers

Shaft End Designator \_\_\_\_\_  
 0 = Shaft End Slotted  
 1 = Shaft End Flatted

Shaft Length Designator \_\_\_\_\_  
 0 = 12.7 mm FMS Long Plastic Shaft (Available w/bushing only)  
 1 = 19.05 mm FMS Long Plastic Shaft (Available w/bushing only)  
 2 = 5.59 mm FMS Long Plastic Shaft (Bushingless version only)

Bushing Designator \_\_\_\_\_  
 Pot (or Pot/Pot):  
 1 = 6.35 mm x 6.35 mm Plastic  
 2 = 6.35 mm x 6.35 mm Ni Plated Brass  
 5 = Bushingless (Board Level Control)

Pot/Switch Bushing Designator (use with "H" terminal style only.)  
 3 = 6.35 mm x 6.35 mm Plastic  
 4 = 6.35 mm x 6.35 mm Ni Plated Brass  
 6 = Bushingless (Board Level)

Resistance Code \_\_\_\_\_  
 (1st 2 digits are significant, 3rd digit is number of 0s to follow)

RoHS Identifier \_\_\_\_\_  
 L = Compliant

# 3310 - 9 mm Square Sealed Panel Control

**BOURNS®**

## Product Dimensions

### COMMON DIMENSIONS 3310-001

Plastic Bushing  
Slotted Shaft



### MOUNTING HOLE PATTERN



### 3310C-001

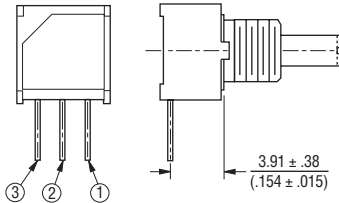

### 3310P-001



### 3310R-001



DIMENSIONS:  $\frac{\text{MM}}{\text{(INCHES)}}$

### 3310Y-001



### COMMON DIMENSIONS 3310C-101

Plastic Flatted Shaft



The shaft flat position as shown above is at 50 % of the mechanical travel.

# 3310 - 9 mm Square Sealed Panel Control

**BOURNS®**

## Product Dimensions

### COMMON DIMENSIONS 3310-002 Metal Bushing



### 3310P-025\* Bushingsless



### 3310C-002

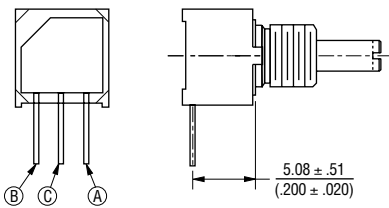

DIMENSIONS:  $\frac{\text{MM}}{\text{(INCHES)}}$

NOTE: \* Only recommended shaft length for bushingsless version

# 3310 - 9 mm Square Sealed Panel Control

**BOURNS®**

## Product Dimensions

**COMMON DIMENSIONS**  
**3310H-003**  
 Pot/Switch Dual Cup  
 Plastic Bushing



**3310H-025\***  
 Pot/Pot Dual Cup  
 Bushingless

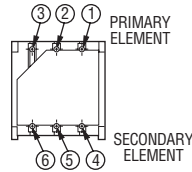

**Pot/Pot Dual Cup**

**3310H-002**  
 Pot/Pot Dual Cup  
 Metal Bushing

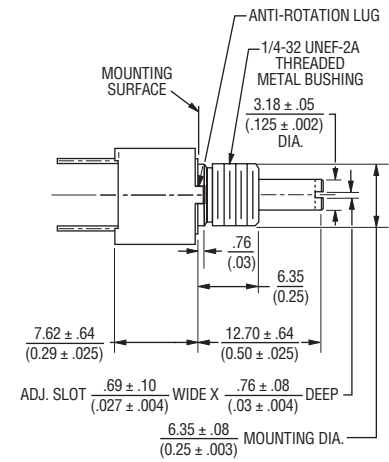

**Pot/Switch Dual Cup**

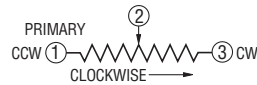

DIMENSIONS:  $\frac{\text{MM}}{\text{(INCHES)}}$

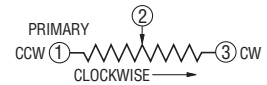

**Pot Single Cup**

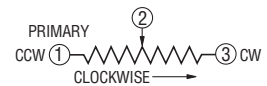

NOTE: \* Only recommended shaft length for bushingless version

REV. 08/12

Specifications are subject to change without notice. Customers should verify actual device performance in their specific applications.



Компания «ЭлектроПласт» предлагает заключение долгосрочных отношений при поставках импортных электронных компонентов на взаимовыгодных условиях!

Наши преимущества:

- Оперативные поставки широкого спектра электронных компонентов отечественного и импортного производства напрямую от производителей и с крупнейших мировых складов;
- Поставка более 17-ти миллионов наименований электронных компонентов;
- Поставка сложных, дефицитных, либо снятых с производства позиций;
- Оперативные сроки поставки под заказ (от 5 рабочих дней);
- Экспресс доставка в любую точку России;
- Техническая поддержка проекта, помощь в подборе аналогов, поставка прототипов;
- Система менеджмента качества сертифицирована по Международному стандарту ISO 9001;
- Лицензия ФСБ на осуществление работ с использованием сведений, составляющих государственную тайну;
- Поставка специализированных компонентов (Xilinx, Altera, Analog Devices, Intersil, Interpoint, Microsemi, Aeroflex, Peregrine, Syfer, Eurofarad, Texas Instrument, Miteq, Cobham, E2V, MA-COM, Hittite, Mini-Circuits, General Dynamics и др.);

Помимо этого, одним из направлений компании «ЭлектроПласт» является направление «Источники питания». Мы предлагаем Вам помощь Конструкторского отдела:

- Подбор оптимального решения, техническое обоснование при выборе компонента;
- Подбор аналогов;
- Консультации по применению компонента;
- Поставка образцов и прототипов;
- Техническая поддержка проекта;
- Защита от снятия компонента с производства.



#### Как с нами связаться

**Телефон:** 8 (812) 309 58 32 (многоканальный)

**Факс:** 8 (812) 320-02-42

**Электронная почта:** [org@eplast1.ru](mailto:org@eplast1.ru)

**Адрес:** 198099, г. Санкт-Петербург, ул. Калинина, дом 2, корпус 4, литера А.