

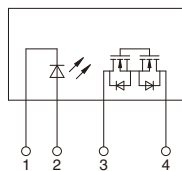

**!** To Be Discontinued  
Last time buy: September 30, 2019

**High capacity up to 6A  
in a slim SIL package**

**PhotoMOS<sup>®</sup>  
Power 1 Form A  
High Capacity (AQZ26○)**

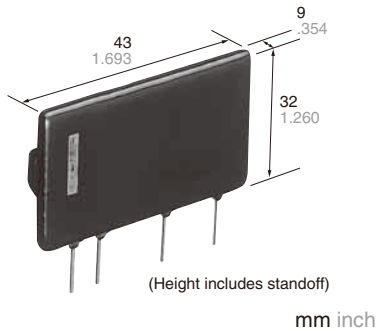

**RoHS compliant**

### FEATURES

**1. High capacity type power PhotoMOS.**

Can switch a wide range of currents and voltages. Can control various types of loads, from very small loads to a max. 6A AC/DC current for sequencers, motors, and lamps.

**2. Low on-resistance and high sensitivity.**

Low on-resistance of less than Typ. 0.036Ω (AQZ262). High sensitivity LED operate current of Typ. 1 mA.

**3. AC/DC dual use**

Bi-directional control is possible. There is no need to differentiate depending on the load as was necessary with the conventional SSR.

**4. 4-pin SIL type**

(L) 43.0 mm × (W) 9.0 mm × (H) 32.0 mm  
(L) 1.693 inch × (W) .354 inch × (H) 1.260 inch.

**5. Low-level off state leakage current of max. 10 μA**

**6. Controls low-level analog signals**  
The triac, photocoupler, or SSR cannot be used to control signals of less than several hundred mV. The high capacity type power PhotoMOS feature extremely low closed-circuit offset voltage to enable control of low-level analog signals without distortion.

### TYPICAL APPLICATIONS

- Mercury relay replacement
- Compact motors, lamps, heaters
- OA equipment

### TYPES

	Output rating*		Package	Part No.	Packing quantity	
	Load voltage	Load current			Inner carton	Outer carton
AC/DC dual use	60 V	6.0 A	SIL4-pin	AQZ262	20 pcs	200 pcs
	400 V	1.0 A		AQZ264		

\* Indicate the peak AC and DC values.

### RATING

**1. Absolute maximum ratings (Ambient temperature: 25°C 77°F)**

Item		Symbol	AQZ262	AQZ264	Remarks
Input	LED forward current	I <sub>F</sub>	50 mA		
	LED reverse voltage	V <sub>R</sub>	5 V		
	Peak forward current	I <sub>FP</sub>	1 A		f = 100Hz, Duty factor = 0.1%
	Power dissipation	P <sub>in</sub>	75 mW		
Output	Load voltage (peak AC)	V <sub>L</sub>	60 V	400 V	
	Continuous load current	I <sub>L</sub>	6.0 A	1.0 A	Peak AC, DC
	Peak load current	I <sub>peak</sub>	10.0 A	3.0 A	100 ms (1shot), V <sub>L</sub> = DC
	Power dissipation	P <sub>out</sub>	3.0 W		
Total power dissipation		P <sub>T</sub>	3.0 W		
I/O isolation voltage		V <sub>iso</sub>	1,500 Vrms		
Ambient temperature	Operating	T <sub>opr</sub>	-40 to +85°C -40 to 185°F		(Non-icing at low temperatures)
	Storage	T <sub>stg</sub>	-40 to +100°C -40 to 212°F		

## 2. Electrical characteristics (Ambient temperature: 25°C 77°F)

Item		Symbol	AQZ262	AQZ264	Condition	
Input	LED operate current	Typical	1.0 mA		$I_L = 100 \text{ mA}$ $V_L = 10 \text{ V}$	
		Maximum	3.0 mA			
	LED turn off current	Minimum	0.4 mA		$I_L = 100 \text{ mA}$ $V_L = 10 \text{ V}$	
		Typical	0.9 mA			
LED dropout voltage	Typical	1.25 V (1.16 V at $I_F = 10 \text{ mA}$ )			$I_F = 50 \text{ mA}$	
	Maximum	1.5 V				
Output	On resistance	Typical	0.036 $\Omega$	1.0 $\Omega$	$I_F = 10 \text{ mA}$ $I_L = \text{max.}$ Within 1 s	
		Maximum	0.05 $\Omega$	1.4 $\Omega$		
	Off state leakage current	Maximum	10 $\mu\text{A}$		$I_F = 0 \text{ mA}$ $V_L = \text{max.}$	
Transfer characteristics	Turn on time*	Typical	5 ms	4 ms	$I_F = 10 \text{ mA}$ $I_L = 100 \text{ mA}$ $V_L = 10 \text{ V}$	
		Maximum	10 ms			
	Turn off time*	Typical	0.32 ms	0.14 ms		$I_F = 10 \text{ mA}$ $I_L = 100 \text{ mA}$ $V_L = 10 \text{ V}$
		Maximum	3.0 ms			
	I/O capacitance	Typical	2.0 pF			$f = 1 \text{ MHz}$ $V_B = 0 \text{ V}$
		Maximum	4.0 pF			
Initial I/O isolation resistance	Minimum	$R_{iso}$	1,000 M $\Omega$		500 V DC	
Max. operating frequency	Maximum	—	0.5 cps		$I_F = 10 \text{ mA}$ Duty factor = 50% $I_L = \text{Max.}, V_L = \text{Max.}$	

\*Turn on/off time

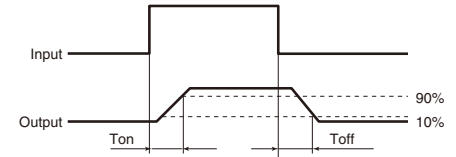

## 3. Recommended operating conditions (Ambient temperature: 25°C 77°F)

Please use under recommended operating conditions to obtain expected characteristics.

Item		Symbol	Min.	Max.	Unit
LED current		$I_F$	10	30	mA
AQZ262	Load voltage (Peak AC)	$V_L$	—	48	V
	Continuous load current	$I_L$	—	6.0	A
AQZ264	Load voltage (Peak AC)	$V_L$	—	320	V
	Continuous load current	$I_L$	—	1.0	A

■ These products are not designed for automotive use.

If you are considering to use these products for automotive applications, please contact your local Panasonic Corporation technical representative.

## REFERENCE DATA

1. Load current vs. ambient temperature characteristics

Allowable ambient temperature: -40 to +85°C  
-40 to +185°F

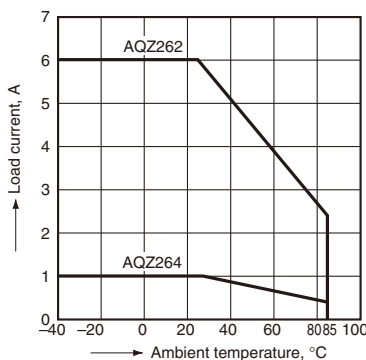

2. Load current vs. ambient temperature characteristics in adjacent mounting

$I_L$ : Load current;  
 $I_L(\text{max.})$ : Maximum continuous load current

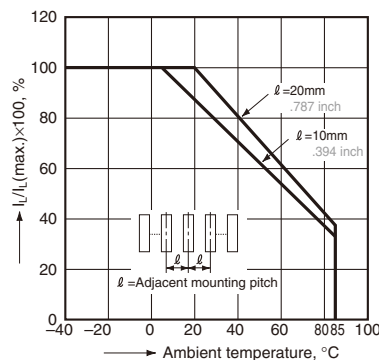

3. On resistance vs. ambient temperature characteristics

LED current: 10 mA;  
Continuous load current: 6A (DC)(AQZ262)  
1A (DC)(AQZ264)

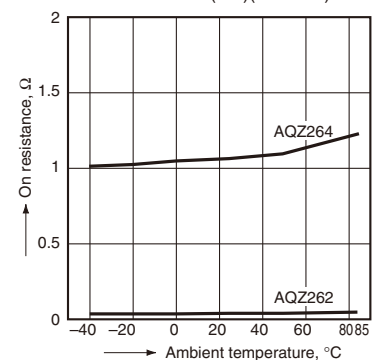

4. Turn on time vs. ambient temperature characteristics

LED current: 10 mA; Load voltage: 10 V (DC);  
Continuous load current: 100 mA (DC)

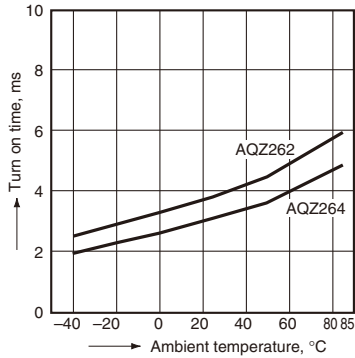

5. Turn off time vs. ambient temperature characteristics

LED current: 10 mA; Load voltage: 10 V (DC);  
Continuous load current: 100 mA (DC)

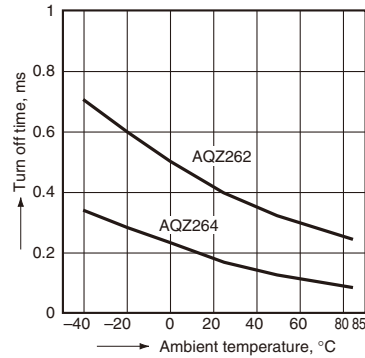

6. LED operate vs. ambient temperature characteristics

Load voltage: 10 V (DC);  
Continuous load current: 100 mA (DC)

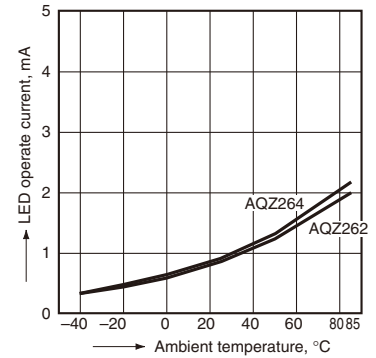

7. LED turn off current vs. ambient temperature characteristics

Load voltage: 10 V (DC);  
Continuous load current: 100 mA (DC)

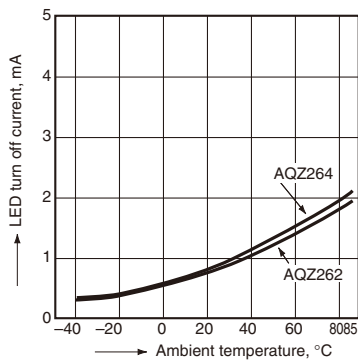

8. LED dropout voltage vs. ambient temperature characteristics

Sample: all types; LED current: 5 to 50 mA

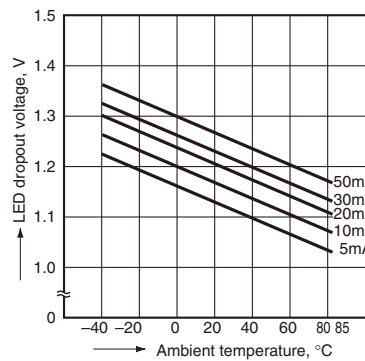

9. Current vs. voltage characteristics of output at MOS portion

Ambient temperature: 25°C 77°F

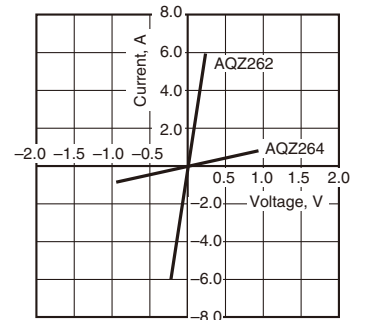

10. Off state leakage current vs. load voltage characteristics

Ambient temperature: 25°C 77°F

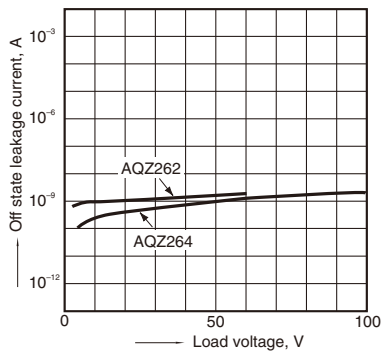

11. Turn on time vs. LED forward current characteristics

Load voltage: 10 V (DC); Continuous load current: 100 mA (DC); Ambient temperature: 25°C 77°F

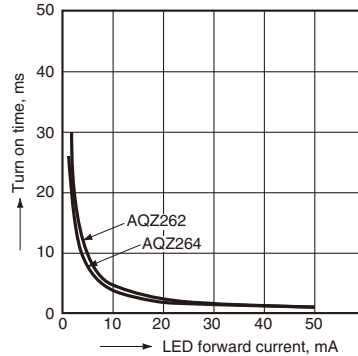

12. Turn off time vs. LED forward current characteristics

Load voltage: 10 V (DC); Continuous load current: 100 mA (DC); Ambient temperature: 25°C 77°F

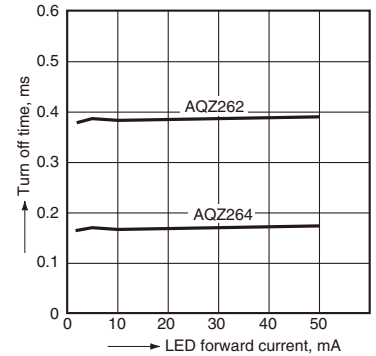

13. Max. operating frequency vs. load voltage/current characteristics

LED current: 10 mA; Ambient temperature: 25°C 77°F

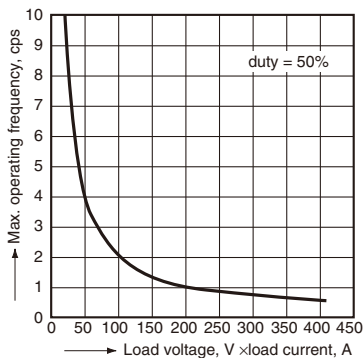

14. Output capacitance vs. applied voltage characteristics

Frequency: 10 KHz; Ambient temperature: 25°C 77°F

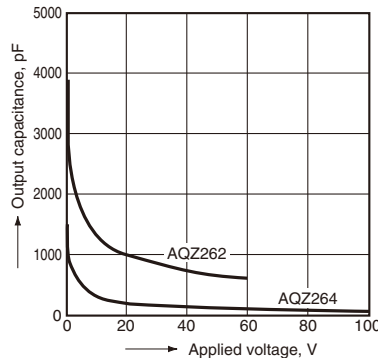

"PhotoMOS<sup>®</sup>", "PhotoMOS" and "PHOTOMOS" are registered trademarks of Panasonic Corporation.

\*Recognized in Japan, the United States, all member states of European Union and other countries.

Please contact .....

---

**Panasonic Corporation**

Electromechanical Control Business Division

■ 1006, Oaza Kadoma, Kadoma-shi, Osaka 571-8506, Japan  
[industrial.panasonic.com/ac/e/](http://industrial.panasonic.com/ac/e/)

**Panasonic<sup>®</sup>**

©Panasonic Corporation 2018

# Mouser Electronics

Authorized Distributor

Click to View Pricing, Inventory, Delivery & Lifecycle Information:

[Panasonic:](#)

[AQZ264](#) [AQZ262](#)



Компания «ЭлектроПласт» предлагает заключение долгосрочных отношений при поставках импортных электронных компонентов на взаимовыгодных условиях!

Наши преимущества:

- Оперативные поставки широкого спектра электронных компонентов отечественного и импортного производства напрямую от производителей и с крупнейших мировых складов;
- Поставка более 17-ти миллионов наименований электронных компонентов;
- Поставка сложных, дефицитных, либо снятых с производства позиций;
- Оперативные сроки поставки под заказ (от 5 рабочих дней);
- Экспресс доставка в любую точку России;
- Техническая поддержка проекта, помощь в подборе аналогов, поставка прототипов;
- Система менеджмента качества сертифицирована по Международному стандарту ISO 9001;
- Лицензия ФСБ на осуществление работ с использованием сведений, составляющих государственную тайну;
- Поставка специализированных компонентов (Xilinx, Altera, Analog Devices, Intersil, Interpoint, Microsemi, Aeroflex, Peregrine, Syfer, Eurofarad, Texas Instrument, Miteq, Cobham, E2V, MA-COM, Hittite, Mini-Circuits, General Dynamics и др.);

Помимо этого, одним из направлений компании «ЭлектроПласт» является направление «Источники питания». Мы предлагаем Вам помощь Конструкторского отдела:

- Подбор оптимального решения, техническое обоснование при выборе компонента;
- Подбор аналогов;
- Консультации по применению компонента;
- Поставка образцов и прототипов;
- Техническая поддержка проекта;
- Защита от снятия компонента с производства.



#### Как с нами связаться

**Телефон:** 8 (812) 309 58 32 (многоканальный)

**Факс:** 8 (812) 320-02-42

**Электронная почта:** [org@eplast1.ru](mailto:org@eplast1.ru)

**Адрес:** 198099, г. Санкт-Петербург, ул. Калинина, дом 2, корпус 4, литера А.