

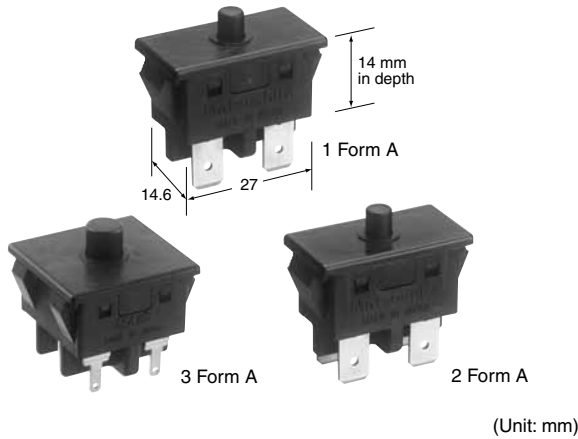

**Compact Size Fail-safe
Door Interlock Switches**

AGX (GX) SWITCHES



RoHS compliant

FEATURES

- 14 mm in depth
- Contact gap is greater than 4mm (Conforming to IEC60950-1)
- Ensure more than 4 mm insulation distance between open contacts
- Constructed with dual restoration springs and double cut-off for safety
- Combination of power contact and signal contact is available (for 3 Form A type)

TYPICAL APPLICATIONS

- Office equipment: Copiers, Printers
- Power supply devices

ORDERING INFORMATION

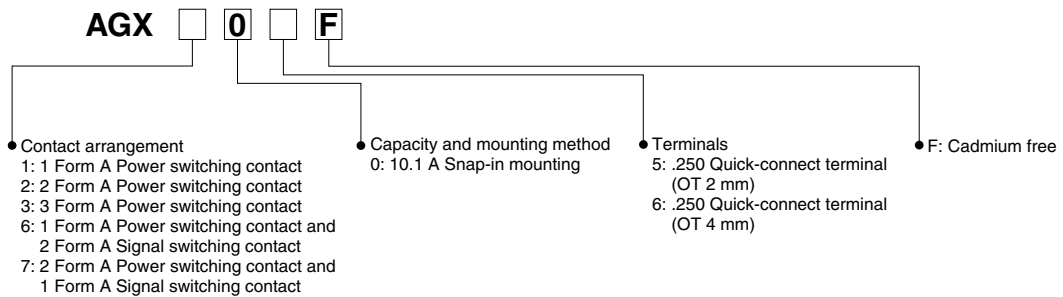

PRODUCT TYPES

| Type | Overtravel (OT) | Contact form | Sequence operation | | Terminal | Part number | |
|--------------------------------|-----------------|--------------|-----------------------------------|----------------|-----------------------------|-----------------|---------|
| | | | 1st ON | 2nd ON | | | |
| Standard type 10.1A 250V AC | Min. 2 mm | 1 Form A | — | — | .250 Quick-connect terminal | AGX105F | |
| | | 2 Form A | — | — | | AGX205F | |
| | Min. 4 mm | 1 Form A | — | — | | AGX106F | |
| | | 2 Form A | — | — | | AGX206F | |
| | | 3 Form A | 3 Form A Power | 3 Form A power | | — | AGX306F |
| | | | 1 Form A Power 2 Form A Signal | 1 Form A power | | 2 Form A signal | AGX606F |
| | | | 2 Form A Power 1 Form A Signal | 2 Form A power | | 1 Form A signal | AGX706F |

CONSTRUCTION (Dual safety construction)

- Dual restoration spring
- Double cut-off type

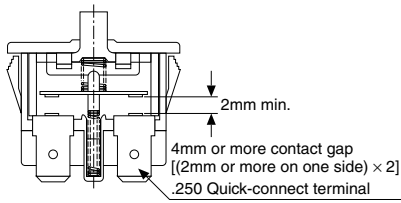

SPECIFICATIONS

■ Contact rating

| Contact type | Resistive load ($\cos \phi \approx 1$) | Motor load* (EN61058-1) ($\cos \phi \approx 0.6$) |
|--|---|---|
| Standard type power switching contact | 10.1A 125V AC 10.1A 250V AC 6A 30V DC 3A 48V DC (3 Form A type only) | 3A 125V AC 3A 250V AC |
| Signal switching contact (3 Form A only) | 0.1A 48V DC Contact Low-level circuit: 1mA 5V DC | — |

Note: Motor load of EN61058-1 designates an inrush current switching capability of 6 times the indicated rating

■ Characteristics

| Item | | Specifications |
|-------------------------------------|---|---|
| Expected life | Mechanical | 10 ⁶ min. (at 60 cpm) |
| | Electrical | 10 ⁵ (at 10.1A 250V AC) (at 20 cpm, operating speed: 10mm/sec.) |
| Insulation resistance | | 100M Ω (at 500V DC) |
| Dielectric strength | Between non-continuous terminals | 2,000Vrms for 1 minute |
| | Between each terminal and other exposed metal parts | 2,500Vrms for 1 minute |
| | Between each terminal and ground | 2,000Vrms for 1 minute |
| Contact resistance | | Initial Max. 100m Ω (by voltage drop at 1A, 6 to 8V DC) |
| Temperature rise (terminal portion) | | Initial Max. 45°C, After test Max. 55°C |
| Vibration resistance | | 10 to 55Hz at single amplitude of 0.75mm (Contact opening: 1 msec. max.), double amplitude of 1.5mm |
| Shock resistance | | Min. 294m/s ² (Contact opening: 1 msec. max.) |
| Actuator strength | | 49N for 1 minute (For operating direction) |
| Tensile terminal strength | | Min. 147N (Pulling for operating direction) |
| Allowable operating speed | | 10 to 300mm/sec. |
| Allowable operating cycle rate | | 60 cpm |
| Heat and cold resistance resistance | | -40°C to -45°C: 48 hours, +80°C to +90°C: 48 hours |
| Ambient temperature | | -25°C to +85°C no freezing and condensing |
| Flame retardancy | | UL94V-0 |
| Tracking resistance (CTI) | | Min. 175 |
| Contact specifications | Contact material | AgCuO alloy |
| Unit weight | | Approx. 15 g |
| Protection grade | | IP40 |

Note: Test condition and judgement are complying with "NECA C4505", "EN61058-1" and "UL1054".

■ Operating characteristics

- Standard type

| Part number (Contact arrangement) | Operating Force (OF) Max. | Total operating Force (TF) Max. Push button position: 2.4mm | Free Position (FP) Max. | Operating Position (OP) | Total Travel Position (TTP) | Over Travel (OT) Min. |
|-----------------------------------|---------------------------|---|-------------------------|-------------------------|-----------------------------|-----------------------|
| AGX105F (1 Form A) | 3.92 N | 4.90 N | 8 mm | 4.8±0.4 mm | 2.4 mm | 2.0 mm |
| AGX205F (2 Form A) | 3.92 N | 4.90 N | 8 mm | 4.8±0.4 mm | 2.4 mm | 2.0 mm |
| AGX106F (1 Form A) | 3.92 N | 6.86 N | 10 mm | 7.0±0.4 mm | 2.4 mm | 4.0 mm |
| AGX206F (2 Form A) | 3.92 N | 6.86 N | 10 mm | 7.0±0.4 mm | 2.4 mm | 4.0 mm |
| AGX306F (3 Form A) | 2.94 N | 5.88 N | 10 mm | 7.0±0.4 mm | 2.4 mm | 4.0 mm |

Note: With the 3 Form A sequence operation type, the specifications for the contact where the operation position turns ON first are as per the above table. However, the specifications for the contact where the operation position turns ON later are delayed by approximately 0.8 mm compared with the above table.

DIMENSIONS

(Unit: mm) General tolerance: ± 0.4

The CAD data of the products with a **CAD Data** mark can be downloaded from: <http://industrial.panasonic.com/ac/e/>

1 Form A type

CAD Data



2 Form A type

CAD Data



External dimensions

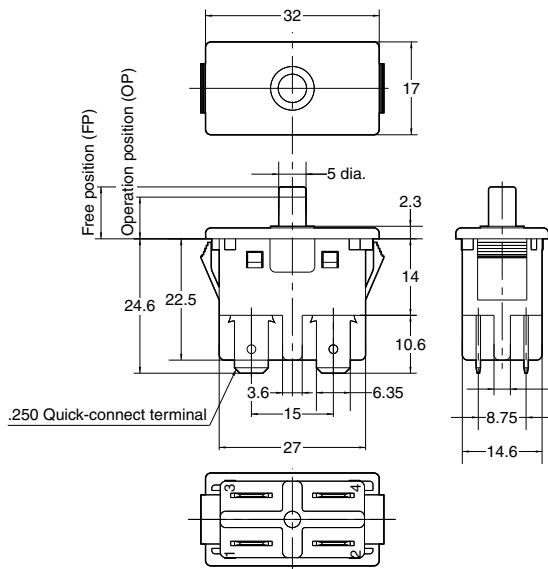

Recommended panel cutting dimension

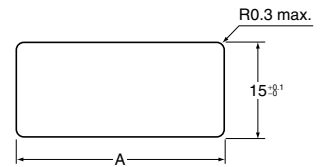

| Panel thickness | 1.0 to less than 1.75 | 1.75 or more to 2.5 |
|-----------------|-----------------------|---------------------|
| Dimension A | $30.2^{+0.1}_{-0}$ | $30.5^{+0.1}_{-0}$ |

(Copper is standard as panel material)

- Notes: 1. 1 Form A type does not have terminal No.1 nor No.2
 2. For FP, OP and TTP, please refer to "Operating characteristics".

3 Form A type

CAD Data



Sequence operation type
(With signal switching contact)



3 Form A power type

External dimensions

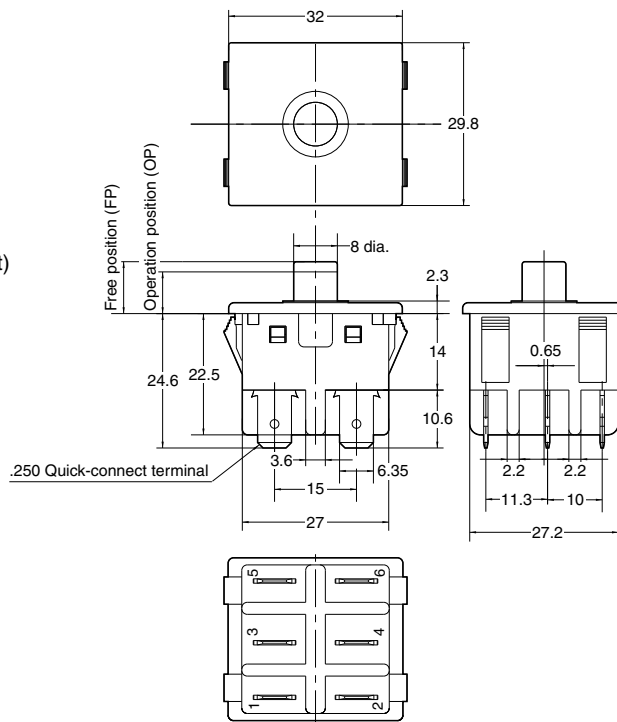

Recommended panel cutting dimension

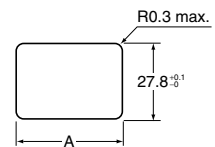

Panel thickness: 0.8 to 2.5mm

| Panel thickness | 0.8 to less than 1.75 | 1.75 or more to 2.5 |
|-----------------|-----------------------|---------------------|
| Dimension A | $30.2^{+0.1}_{-0}$ | $30.5^{+0.1}_{-0}$ |

(Copper is standard as panel material)

- Front view of sequence operation type (With signal switching contact)

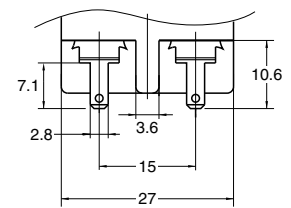

Note: Power switching contact type has .250 Quick-connect terminal and signal switching contact type has .110 Quick-connect terminal.

CAUTIONS FOR USE

■ Switch mounting

Mount the switch with the panel cutting dimensions shown in the drawing.

Please contact us if you consider using the other panel cutting dimensions.

■ Adjustment of the operating device

With respect to the position of the operating device and the switch body, set the position as indicated in the condition. If this condition is exceeded, the mechanical and electrical performance will be impaired. In addition, the force applied by the operating device should be in a perpendicular direction.

Even if the pushbutton is used in the full over travel "OT", there will be no influence on the life of the switch.

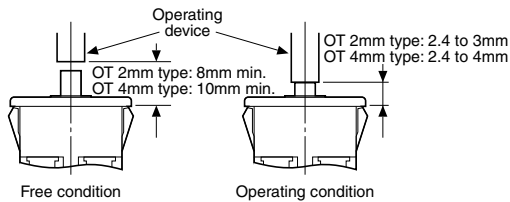

■ Confirming insulating distance

Before mounting and wiring, the insulating distance between terminals and between the terminals and ground should be checked for assurance of proper distance. With respect to the terminal connections, it is recommended that receptacles with insulating sleeves or positive lock connector be used. Also consideration should be given to the wiring not to apply force to the terminal section normally.

■ Regarding fastening lead wires to terminals

Use .250 receptacle (terminal thickness 0.8mm) or .110 receptacle (terminal thickness 0.5mm) should be used for connection. Make sure the sockets are straight. If they are skewed, the terminals will require excessive insertion force. The insertion force varies according to manufacturer's specifications. Check it for the sockets you are using.

■ Material of the mounting panel

Steel sheet is recommended as the mounting panel material. When using soft material, confirm the condition for actual use.

■ Quality check

To improve reliability, check the switch under actual loading conditions.

■ Environment

Avoid using and storing these switches in a location where they will be exposed to corrosive gases, silicon, or high dust levels, all of which can have an adverse effect on the contacts.

REFERENCE

■ Outline of UL1054 test

Overload test

Standard type: 12.625A 250V AC
(Power factor 0.75 to 0.8)

Endurance test

Standard type: 10.1A 250V AC
(Power factor 0.75 to 0.8)

After testing, temperature rise of terminals should be less than 30°C and no abnormality should be observed in characteristics.

■ Outline of EN61058-1 test

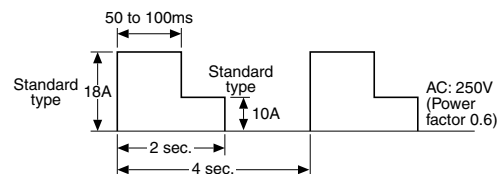

After switching 25,000 times on the above load condition at both 85⁺⁵°C and 25±10°C, temperature rise of terminals should be less than 55°C and no abnormality should be observed in characteristics.

INTRODUCTION OF CONNECTORS FOR AGX (GX) SWITCHES (made by Nippon Tanshi Co., Ltd)

■ Connector for 2 Form A

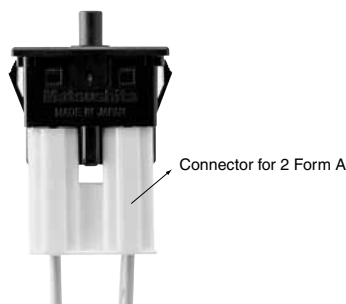

Applicable AGX (GX) switch part No.: AGX205F, AGX206F

- Housing
Model number: N1620-4204
- Receptacle
Model numbers: 17168-2 (for narrow wires, post-plated product)
17168-M2 (for narrow wires, wood veneer plated product)
172131-M2 (for thick wires)

■ Connector for 2 Form A power terminal of 2 Form A power + 1 Form A signal type

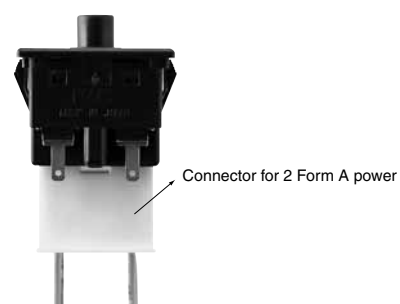

Applicable AGX (GX) switch part No.: AGX706F

- Housing
Model number: N3220-4204
- Receptacle
Model numbers: 17901-M2, 17902-M2, 17903-M2 (wire size differences)
- If you have any questions, please directly contact:
Nippon Tanshi Co., Ltd.

Note: Please note that Panasonic does not sell the connector for AGX (GX) switches.

Technical Terminology & Cautions for Use

(Snap-action, Detection and Interlock Switches)

TECHNICAL TERMINOLOGY

■ Snap-action switches

A compact switch equipped with an enclosed micro-gap snap-action contact mechanism that makes a specified motion with a specified force to open/close a circuit, and an actuator outside the enclosure (hereinafter referred to as the switch)

■ Actuator

A part of the switch that transmits the received external force to an internal spring mechanism to move the movable contact so that the switch can be opened and closed

■ Actuator stopper

A part of the switch to limit the actuator movement in the switch operation direction

■ Rated values

Values indicating the characteristics and performance guarantee standards of the snap-action switches. The rated current and rated voltage, for instance, assume specific conditions (type of load, current, voltage, frequency, etc.).

■ Mechanical life



The service life when operated at a preset operating frequency without passing electricity through the contacts. (The life test is performed at a switching frequency of 60 times/minute and operating speed of 100 mm/second at the regular cam.)

■ Electrical life

The service life when the rated load is connected to the contact and switching operations are performed. (The life test is performed at a switching frequency of 20 times/minute and operating speed of 100 mm/second at the regular cam.)

■ Contact form

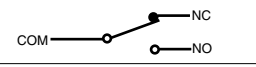
This refers to the components determining the type of application which make up the electrical input/output circuits in the contact.

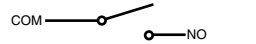
| | |
|---------|---|
| SPDT |  |
| SPST-NC |  |
| SPST-NO |  |

Terminal symbols

COM: Common terminal

NC: Normally closed terminal

NO: Normally open terminal

■ Insulation resistance

Resistance between non-continuous terminals, each terminal and other exposed metal parts and between each terminal and ground.

■ Dielectric

Threshold limit value that a high voltage can be applied to a predetermined measuring location for one minute without causing damage to the insulation.

■ Contact resistance

This indicates the electrical resistance at the contact part. Generally, this resistance includes the conductor resistance of the spring and terminal portions.

■ Vibration resistance

Malfunction vibration ... Vibration range where a closed contact does not open for longer than a specified time due to vibrations during use of the snap-action switches.

■ Shock resistance

Shock durability ... Shock range where the mechanical shocks received during snap-action switches transport and installation do not damage the parts or harm the operating characteristics. Malfunction shock ... Shock range where a closed contact does not open for longer than a specified time due to shocks during use of the snap-action switches.

OPERATING CHARACTERISTIC

■ Definition of operating characteristic

The main terminological illustrations and meanings which are used with snap-action switches are as follows.

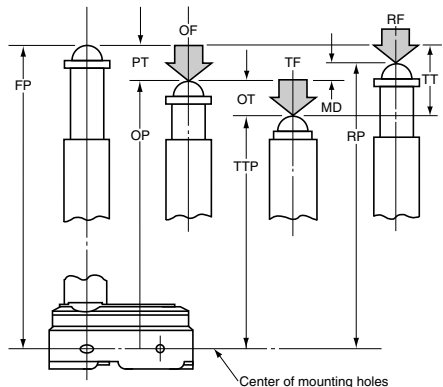

| Classification | Terminology | Symbol | Unit | Varying display method | Starting current |
|----------------|-----------------------|--------|------------|------------------------|---|
| Force | Operating Force | OF | N | Max. | The force required to cause contact snap-action. It is expressed in terms of force applied to the actuator. |
| | Release Force | RF | N | Min. | The force to be applied to the actuator at the moment contact snaps back from operated position to total travel position. |
| | Total travel Force | TF | N | | Force applied to an actuator required to move from an operating position to a total travel position |
| Movement | Pretravel | PT | mm, degree | Max. | Distance or degree of the actuator movement from free position to operating position. |
| | Overtravel | OT | mm, degree | Min. | The distance or degree which the actuator is permitted to travel after actuation without any damage to the switching mechanism. |
| | Movement Differential | MD | mm, degree | Max. | The distance or degree from operating position to release position of the actuator. |
| | Total travel | TT | mm, degree | | The migration length or the move angle from the free position to total travel position of actuator |
| Position | Free Position | FP | mm, degree | | Position of the actuator when no force is applied to. |
| | Operating Position | OP | mm, degree | ± | The position of the actuator when the traveling contacts snaps with the fixed contact. |
| | Release Position | RP | mm, degree | | The position of the actuator when the traveling contact snaps back from operating position to its original position. |
| | Total travel Position | TTP | mm, degree | | The stopping position of the actuator after total travel. |

TECHNICAL NOTES ON MECHANICAL CHARACTERISTICS

■ Actuation Force and Stroke

Adequate stroke setting is the key to high reliability. It is also important that adequate contact force be maintained to ensure high reliability. For a normally closed (NC) circuit, the driving mechanism should be set so that the actuator is normally in the free position. For a normally open (NO) circuit, the actuator should be pressed to 70% to 100% of the specified stroke to absorb possible errors.

If the stroke is set too close to the operating point (OP), this may cause unstable contact, and in the worst case may cause actuator damage due to inertia of the drive mechanism. It is advisable that the stroke be adjusted with the mounting plate or driving mechanism.

The figure at right shows a typical example of activation and contact forces varying with stroke. In the vicinity of the OP and RP, the contact force is diminished, causing chatter and contact bounce immediately before or after reversal. For this reason, use the switch while giving due consideration to this. This also causes the snap action switch to be sensitive to vibration or shock.

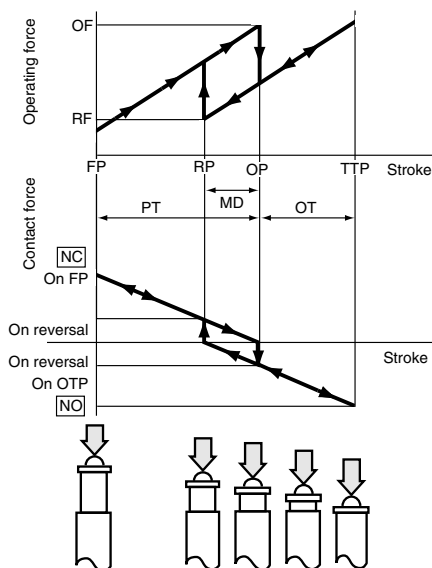

■ Changes in Operating Characteristics

Exercise design care so that malfunctions will not occur if the operating characteristics vary by as much as 20% from, rated values.

<Example>

In the OF max. 0.98N specification for FS snap-action switches, the allowable max. is $0.98 \text{ N} \times (100\%+20\%) = 1.18 \text{ N}$

In the RF min. 0.15 N min. specification the allowable min. $0.15 \text{ N} \times (100\%-20\%) = 0.12 \text{ N}$

■ Mechanical Conditions for Type Selection

Actuator type should be selected according to activation method, activation speed, activation rate, and activation frequency.

- 1) An extremely slow activation speed may cause unstable contact transfer, possibly resulting in contact failures or contact fusion.
- 2) An extremely high activation speed may cause damage to contacts or contact response failure.

■ Driving Mechanism

Use of a driving mechanism which will cause physical impact to the actuator should be avoided.

<Example>

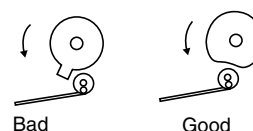

TECHNICAL NOTES ON ELECTRICAL CHARACTERISTICS

1) The snap-action switch is designed for AC operations. While it has small contact gaps and no arc absorber, it may be used for low-capacity DC operations.

Please refer to the rating of each products

2) For applications with very small switching voltage or current, choose the low-level load type (Au contact).

Small current and voltage application range (Au contact)

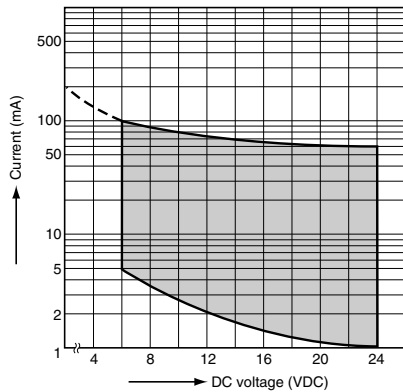

3) When selecting a contact type of a snap-action switch to be used for low-level load switching, the following should be noted. Silver contacts' surfaces are prone to be oxidized and form a sulfide film. The switch operates with no problems at the

beginning of use. However, as the contact surfaces develop films with time, the film may not be broken by the switching operation, causing a conduction failure. Therefore, please choose the Au contact type for switching a load of 0.1 A or below.

4) Application to Electronic Circuits

- The snap-action switch contacts can sustain bounce or chatter when closed. Bounce or chatter can cause noise or pulse count errors when the snap action switch is used in electronic circuits.

- If contact bounce or chatter poses problems in the vicinity of the OP and RP, use a suitable absorption network, such as a C/R network.

5) Check the surge current, normal current and surge duration.

6) Contact resistance given in performance specifications is measured with a voltage drop method using 6 to 8 V DC, 1 A (except for low-level load type). Contact resistance across COM and NC terminals is measured in the free position, while contact resistance across COM and NO terminals is measured in the total travel position.

7) Ratings are measured under the following conditions:

Inductive load: Power factor 0.6 to 0.7

Time constant: 7 ms or less (DC)

8) To prevent contact welding failure, be sure to use a serial resistance for each capacitive load.

9) If snap-action switch operation is synchronized with the AC supply phase, this may cause: shortened electrical life, contact fusion failure, contact transfer, or other reliability problems.

CAUTIONS IN A CIRCUIT

1) Contact protection is recommended when snap-action switches are used in an inductive load circuit.

| Circuit diagram | Cautions for use |
|-----------------|---|
| | (1) $r =$ more than $10\ \Omega$ (2) In an AC circuit Impedance of R is to be slightly smaller than impedance of r and c. |
| | Can be used for both AC and DC. Impedance of r is nearly equal to impedance of R. C: $0.1\ \mu\text{F}$ |
| | (1) For DC circuits only. |
| | Can be used for both AC and DC. |

2) Do not connect the contacts on individual switches to different type or different poles of the power supply. Examples of power supply connections (connection to different poles)

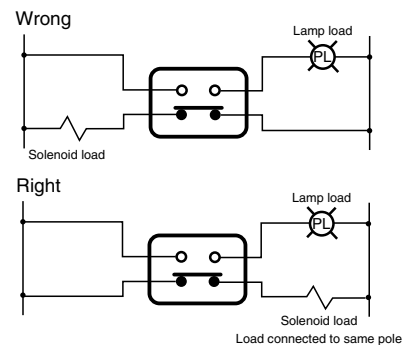

Example of wrong power supply connection (connection to different poles of power supply)
 This may lead to mixed DC and AC.

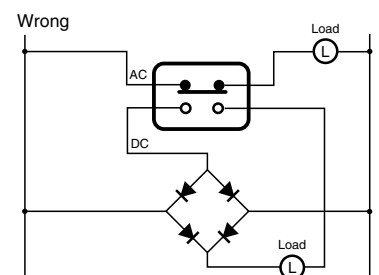

3) Avoid circuits which apply voltage between contacts. (This may lead to mixed deposition.)

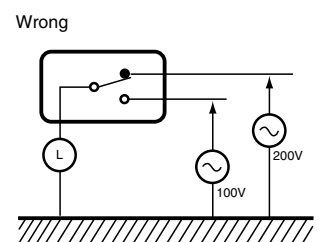

MOUNTING STATE AND ENVIRONMENT

■ Checking the insulation distance

After mounting and wiring, check the insulation distance between terminals and the ground. If the insulation distance is inadequate, mount insulating material between as required.

■ Fastening the snap-action switch body

See the Section "CAUTIONS FOR USE" for the individual switch.

■ Position adjustment with effector

- 1) The effector should be positioned so that direct force is not applied to the plunger or actuator in its free position. The operating force to the plunger should only be applied in a perpendicular direction.
- 2) Note that the use of the switch as a stopper may cause an operational problem.

■ Switch installation position

- Basically, the switch should be installed so that the object to press the switch's plunger or lever can press it down to 70 to 100% of OT of the switch. When determining the position, the tolerance of OP (Operating Position) and other factors should be taken into account.

The following describes the case where the strictest tolerance conditions are adopted.

- Example: Hinge lever type FS switch

Reference values: OP = 8.8 ± 0.8 mm
 PT = max. 2.8mm
 OT = min. 1.2mm

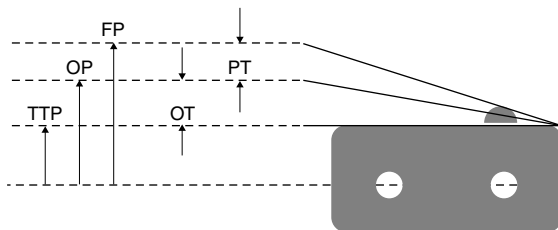

- (1) When the switch is not pressed
 The object to press the lever should not be in contact with the lever.
 For this purpose, the object should be at a distance from the switch fater than the maximum FP (Free Position) value.
 $FP \text{ max} = OP \text{ max} + PT \text{ max} = 9.6 + 2.8 = 12.4 \text{ mm max}$
 The object should be at a distance of 12.4 mm or more from the mounting hole.
- (2) Depressed position
 The plunger/lever should be pressed down to 70% or more of OT (Over Travel). Therefore, the depressed position should be calculated based on the minimum value of OP (Operating Position) and the 70 and 100% of the OT value.
 $OP \text{ min} - 70\% \text{ of OT} = 8.0 - 0.84 = 7.16 \text{ mm}$
 $OP \text{ min} - 100\% \text{ of OT} = 8.0 - 1.2 = 6.80 \text{ mm}$
 The plunger/lever should be pressed down to the position of 6.80 to 7.16 mm from the mounting hole.

■ Soldering precautions

For manual soldering, lay the terminals flat (horizontal with the ground) and quickly perform the soldering operation using a soldering iron with the appropriate heat capacity and the proper amount of solder. Take care that the flux does not flow into the switch interior by using a ventilation fan to discharge flux gas and to prevent contact of the switch body with the soldering iron tip.

Be careful not to apply force to the lead wires or the terminal portions immediately after soldering.

The temperature setting and time conditions vary depending on the product.

See the section "CAUTIONS FOR USE" for each product.

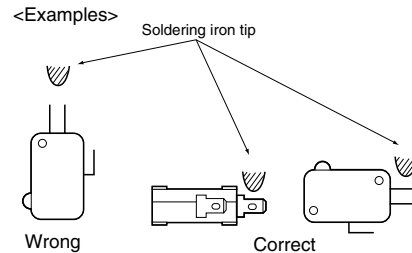

■ Avoid using in a silicon atmosphere

Avoid using organic silicon rubber, adhesives, sealing compounds, oil, grease, and wires in a silicon atmosphere.

■ Please consult us when using under the following conditions*:

- 1) Environments where hydrogen sulfide or other corrosive gases are present.
- 2) Environments where gasoline, thinner or other flammable, explosive gases are present.
- 3) Dusty environments (for non-seal type snap action switches).
- 4) The perpendicular operating speed exceeds the allowable operating speed.
- 5) Switching between different poles.
- 6) Use in environments not in the prescribed temperature or humidity range.

■ Storage precautions

To prevent discoloration due to sulfurization of the terminals (silver-plated), store the switches in a polyethylene bag or other suitable airtight container.

■ Usage, storage, and transport conditions

During usage, storage, or transportation, avoid locations subject to direct sunlight and maintain normal temperature, humidity, and pressure conditions.

The allowable specifications for environments suitable for usage, storage, and transportation are given below.

1) Temperature: The allowable temperature range differs for each switch, so refer to the switch's individual specifications. In addition, when transporting or storing switches while they are tube packaged, there are cases when the temperature may differ from the allowable range. In this situation, be sure to consult the individual specifications.

2) Humidity: 5 to 85% R.H.

3) Pressure: 86 to 106 kPa

The humidity range varies with the temperature. Use within the range indicated in the graph below.

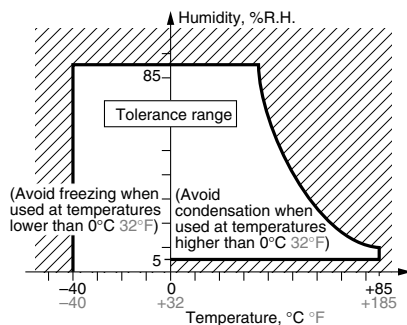

(The allowable temperature depends on the switch.)

- Condensation will occur inside the switch if there is a sudden change in ambient temperature when used in an atmosphere of high temperature and high humidity. This is particularly likely to happen when being transported by ship, so please be careful of the atmosphere when shipping. Condensation is the phenomenon whereby steam condenses to cause water droplets that adhere to the switch when an atmosphere of high temperature and humidity rapidly changes from a high to low temperature or when the switch is quickly moved from a low humidity location to one of high temperature and humidity. Please be careful because condensation can cause adverse conditions such as deterioration of insulation, coil cutoff, and rust.
- Condensation or other moisture may freeze on the switch when the temperatures is lower than 0°C 32°F. This causes problems such as sticking of movable parts or operational time lags.
- The plastic becomes brittle if the switch is exposed to a low temperature, low humidity environment for long periods of time.
- Storage for extended periods of time (including transportation periods) at high temperatures or high humidity levels or in atmospheres with organic gases or sulfide gases may cause a sulfide film or oxide film to form on the surfaces of the contacts and/or it may interfere with the functions. Check out the atmosphere in which the units are to be stored and transported.
- In terms of the packing format used, make every effort to keep the effects of moisture, organic gases and sulfide gases to the absolute minimum.

■ We reserve the right to modify without notice the materials, internal components, and other parts to improve product quality.

■ Handling precautions

When handling the switches, be careful not to drop them on the floor since this may damage them.

* Select contact sulfurization (clipping) prevention products (FS and Au-clad double layer contacts) for use with extremely small loads or an environment-resistant Turquoise switch.















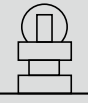

■ Others

1) Failure modes of switches include short-circuiting, open-circuiting and temperature rises. If this switch is to be used in equipment where safety is a prime consideration, examine the possible effects of these failures on the equipment concerned, and ensure safety by providing protection circuits or protection devices. In terms of the systems involved, make provision for redundancy in the design and take steps to achieve safety design.

2) The ambient operating temperature (and humidity) range quoted is the range in which the switch can be operated on a continuous basis: it does not mean that using the switch within the rating guarantees the durability performance and environment withstanding performance of the switch. For details on the performance guarantee, check the specifications of each product concerned.

Technical Terminology & Cautions for Use

■ Types of actuators

| Shape | Classification | Pretravel (PT) | Overtravel (OT) | Operating Force (OF) | Vibration Shock | Features | |
|--|--|----------------|-----------------|----------------------|-----------------|---|--|
|  | Pin plunger | Small | Small | Large | Out-standing | Appropriate for linear short-stroke action. Pin plunger acts directly on snap action mechanism, enabling high-precision positioning. Amount of movement after operation is smallest among all of the actuators, however, so reliable stopper is required. | |
|  | Spring small plunger | Small | Medium | Large | Excellent | Used in much the same way as the pin plunger, but is easier to use because the amount of movement after operation is larger. | |
|  | Spring short plunger | Small | Medium | Large | Good | Pin plunger is short, with large plunger diameter that makes centering easier. Like small spring plunger, amount of movement after operation is large. | |
|  | Panel attachment plunger | Small | Large | Large | Good | Secured to panel with hex or lock nut; used as manual or mechanical plunger. Amount of movement after operation is extremely large and operation point can be adjusted by changing attachment position. Can be used in combination with low-speed cam. | |
|  | Panel attachment roller plunger | Small | Large | Large | Possible | This is the panel attachment type with a roller, and can be used with fast-moving cams and dogs.. | |
|  | Hinge lever | Large | Medium | Small | Possible | Little force required for operation. Appropriate for use with low-speed cams and dogs; has large stroke. Lever available in various shapes to fit operating unit. | |
|  | Simulated roller lever | Large | Medium | Small | Possible | Tip of hinge lever is bent into a semi-circle, enabling use as a simple roller type. | |
|  | Leaf lever | Large | Large | Small | Excellent | Play in lever is used to assure maximum stroke. Construction provides for space where lever is attached, for outstanding resistance to freezing. | |
|  | Hinge roller lever | Large | Medium | Small | Possible | This is a hinge lever with a roller, and can be used with high-speed cams and dogs. The force required for pin plunger action is lighter than that of the lever, and the stroke is longer. | |
|  | One way action hinge roller lever | Medium | Medium | Medium | Possible | This is hinge roller lever type, and can operate in relation to an operating unit from a one way direction, but the roller is bent from the opposite direction and cannot move. This can be used to prevent reverse-direction action. | |
|  | Leaf spring | Medium | Medium | Medium | Good | This has a leaf spring with offset yield force and has a large stroke. Ideal for driving low-speed cams and cylinders. Fulcrum is fixed for high precision. To prevent leaf damage, movement after operation must be within specified value. | |
|  | Roller leaf spring | Medium | Medium | Medium | Good | This is a leaf spring with a roller, and can be used with high-speed cams. | |
|  | (OC reversed action groove type) Reverse-action hinge lever | Large | Small | Medium | Excellent | This is used for low-speed, low-torque cams. The lever comes in various shapes to fit the operating body. | The plunger is constantly pressed down by a coiled spring, and operating the lever induces reverse action. Because the plunger is depressed when not engaged, vibration and shock resistance are excellent. Pressing the plunger too far does not cause abnormal force to be applied to the switch mechanism, so a stable service life is assured. |
|  | (OC reversed action groove type) Reverse-action hinge roller lever | Medium | Medium | Medium | Excellent | This is a reverse-action hinge lever with a roller and is appropriate for cam operation. Excellent resistance to vibration and impact when not engaged. | |
|  | (OC reversed action groove type) Reverse-action hinge roller short lever | Small | Medium | Large | Excellent | This is a shorter version of the reverse-action hinge lever with a roller and has a larger action force, but is appropriate for cam operation with a short stroke. Excellent resistance to vibration and impact when not engaged. | |
|  | Rotating-action type | Large | Large | Small | Possible | This is a rotating, light-action type that is ideal for detecting paper, coins, and similar objects. | |

Mouser Electronics

Authorized Distributor

Click to View Pricing, Inventory, Delivery & Lifecycle Information:

[Panasonic:](#)

[AGX706F](#)



Компания «ЭлектроПласт» предлагает заключение долгосрочных отношений при поставках импортных электронных компонентов на взаимовыгодных условиях!

Наши преимущества:

- Оперативные поставки широкого спектра электронных компонентов отечественного и импортного производства напрямую от производителей и с крупнейших мировых складов;
- Поставка более 17-ти миллионов наименований электронных компонентов;
- Поставка сложных, дефицитных, либо снятых с производства позиций;
- Оперативные сроки поставки под заказ (от 5 рабочих дней);
- Экспресс доставка в любую точку России;
- Техническая поддержка проекта, помощь в подборе аналогов, поставка прототипов;
- Система менеджмента качества сертифицирована по Международному стандарту ISO 9001;
- Лицензия ФСБ на осуществление работ с использованием сведений, составляющих государственную тайну;
- Поставка специализированных компонентов (Xilinx, Altera, Analog Devices, Intersil, Interpoint, Microsemi, Aeroflex, Peregrine, Syfer, Eurofarad, Texas Instrument, Miteq, Cobham, E2V, MA-COM, Hittite, Mini-Circuits, General Dynamics и др.);

Помимо этого, одним из направлений компании «ЭлектроПласт» является направление «Источники питания». Мы предлагаем Вам помощь Конструкторского отдела:

- Подбор оптимального решения, техническое обоснование при выборе компонента;
- Подбор аналогов;
- Консультации по применению компонента;
- Поставка образцов и прототипов;
- Техническая поддержка проекта;
- Защита от снятия компонента с производства.



Как с нами связаться

Телефон: 8 (812) 309 58 32 (многоканальный)

Факс: 8 (812) 320-02-42

Электронная почта: org@eplast1.ru

Адрес: 198099, г. Санкт-Петербург, ул. Калинина, дом 2, корпус 4, литера А.