

GENERAL DESCRIPTION

The SP6260 family is a series of CMOS positive low noise voltage regulators capable of delivering up to 200mA of continuous current.

Each of these devices consists of a voltage reference, an error amplifier, a resistor network for setting the output voltage, a current limit circuit for current protection and a chip enable circuit.

The SP6260 series feature high ripple rejection, low dropout voltage, low noise, high output voltage accuracy and low current consumption which make them ideal for use in various battery-powered and hand-held devices.

The SP6260 series is offered in the following fixed output voltage options: 1.2V, 1.5V, 1.8V, 2.5V, 2.8V, 3.0V, 3.2V and 3.3V.

The SP6260 family is available in standard lead free, RoHS compliant 5-pin SOT-23 package.

APPLICATIONS

- **Hand Held Equipments**
- **Wireless Communication Devices**
- **Battery Powered Equipments**
- **Industrial and Medical Equipments**

FEATURES

- **200mA Continuous Output Current**
 - 150mV Dropout Voltage @ $I_{OUT}=100mA$ (Except 1.2V and 1.5V Version)
 - 1.2V to 3.3V Fixed Output Voltages
 - $\pm 2\%$ Output Voltage Accuracy
- **2V Minimum Input Voltage**
- **30 μ Vrms Output Noise (10Hz-100KHz)**
- **70dB Power Supply Rejection Ratio**
- **4mV Line Regulation (typ)**
- **12mV Load Regulation (typ)**
- **Low Standby Current: 0.1 μ A Typical**
- **Low Quiescent Current: 25 μ A Typical**
- **Lead Free, RoHS Compliant 5-pin SOT-23 Package**

TYPICAL APPLICATION DIAGRAM

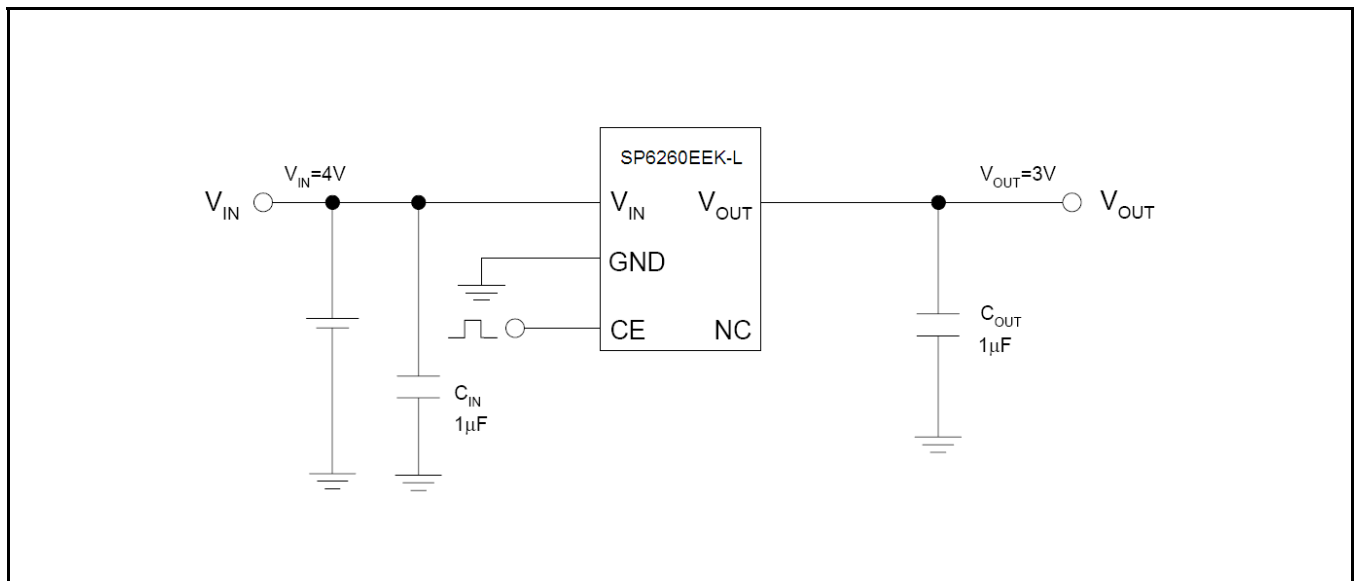

Fig. 1: SP6260 Application Diagram



ABSOLUTE MAXIMUM RATINGS

These are stress ratings only and functional operation of the device at these ratings or any other above those indicated in the operation sections of the specifications below is not implied. Exposure to absolute maximum rating conditions for extended periods of time may affect reliability.

Input Voltage V_{IN} 6.5V
 Enable Pin Input Voltage -0.3 to $V_{IN}+0.3V$
 Output Current..... 300mA
 Junction Temperature 150°C
 Storage Temperature Range -65°C to 150°C
 Lead Soldering (Sold. 10sec) 260°C
 ESD Rating (HBM - Human Body Model) 2kV
 ESD Rating (MM - Machine Model) 200V

OPERATING RATINGS

Input Voltage Range V_{IN}2.0 to 6.0V
 Junction Temperature Range T_J -40°C to 85°C
 Thermal Resistance θ_{JA} 250°C/W
 Thermal Resistance θ_{JC} 74°C/W

ELECTRICAL SPECIFICATIONS

Specifications with standard type are for an Operating Junction Temperature of $T_J = 25^\circ C$ only; limits applying over the full Operating Junction Temperature range of -40°C to 85°C are denoted by a “•”. Minimum and Maximum limits are guaranteed through test, design, or statistical correlation. Typical values represent the most likely parametric norm at $T_J = 25^\circ C$, and are provided for reference purposes only.

SP6260HEK (1.2V)

Unless otherwise indicated, $V_{IN} = 2.2V$, $C_{IN} = 1\mu F$, $C_{OUT} = 1\mu F$.

| Parameter | Min. | Typ. | Max. | Units | Conditions |
|--|-------|-----------|-------|------------------|---|
| Output Voltage V_{OUT} | 1.176 | 1.2 | 1.224 | V | $V_{IN}=2.2V$ $1mA \leq I_{OUT} \leq 30mA$ |
| Input Voltage V_{IN} | | | 6 | V | |
| Output Current I_{OUT} | 200 | | | mA | $V_{IN}-V_{OUT}=1V$ |
| Load Regulation V_{RLOAD} | | 12 | 40 | mV | $V_{IN}=2.2V$ $1mA \leq I_{OUT} \leq 80mA$ |
| Line Regulation V_{RLINE} | | 4 | 16 | mV | $2.2V \leq V_{IN} \leq 6V$ $I_{OUT}=30mA$ |
| Dropout Voltage V_{DROP} | | 700 | 900 | mV | $I_{OUT}=10mA$ |
| | | 700 | 900 | | $I_{OUT}=100mA$ |
| | | 700 | 900 | | $I_{OUT}=150mA$ |
| | | 700 | 900 | | $I_{OUT}=200mA$ |
| Quiescent Current I_Q | | 25 | 50 | μA | $V_{IN}=2.2V, I_{OUT}=0mA$ |
| Standby Current I_{STD} | | 0.1 | 1 | μA | $V_{IN}=2.2V$ V_{CE} in OFF mode |
| Power Supply Rejection Ratio PSRR | | 70 | | dB | Ripple 0.5V _{p-p} , f=10kHz $V_{IN}=2.5V$ |
| Output Voltage Temperature Coefficient | | ± 120 | | $\mu V/^\circ C$ | • $\Delta V_{OUT}/\Delta T$ |
| | | ± 100 | | ppm/ $^\circ C$ | • $(\Delta V_{OUT}/V_{OUT})/\Delta T$ |
| Short Current Limit I_{LIMIT} | | 50 | | mA | $V_{OUT}=0V$ |
| RMS Output Noise V_{NOISE} | | 30 | | μV_{rms} | $T_A=25^\circ C$ $10Hz \leq f \leq 100kHz$ |
| CE “High” Voltage | 1.5 | | | V | CE input voltage “High” |
| CE “Low” Voltage | | | 0.25 | V | CE input voltage “Low” |
| CE Pull-down Resistance R_{PD} | 2.5 | 5 | 10 | M Ω | |



SP6260AEK (1.5V)

Unless otherwise indicated, $V_{IN} = 2.5V$, $C_{IN} = 1\mu F$, $C_{OUT} = 1\mu F$.

| Parameter | Min. | Typ. | Max. | Units | Conditions |
|--|------|-----------|------|------------------|---|
| Output Voltage V_{OUT} | 1.47 | 1.5 | 1.53 | V | $V_{IN}=2.5V$ $1mA \leq I_{OUT} \leq 30mA$ |
| Input Voltage V_{IN} | | | 6 | V | |
| Output Current I_{OUT} | 200 | | | mA | $V_{IN}-V_{OUT}=1V$ |
| Load Regulation V_{RLOAD} | | 12 | 40 | mV | $V_{IN}=2.5V$ $1mA \leq I_{OUT} \leq 80mA$ |
| Line Regulation V_{RLINE} | | 4 | 16 | mV | $2.3V \leq V_{IN} \leq 6V$ $I_{OUT}=30mA$ |
| Dropout Voltage V_{DROP} | | 400 | 600 | mV | $I_{OUT}=10mA$ |
| | | 400 | 600 | | $I_{OUT}=100mA$ |
| | | 400 | 600 | | $I_{OUT}=150mA$ |
| | | 400 | 600 | | $I_{OUT}=200mA$ |
| Quiescent Current I_Q | | 25 | 50 | μA | $V_{IN}=2.5V, I_{OUT}=0mA$ |
| Standby Current I_{STD} | | 0.1 | 1 | μA | $V_{IN}=2.5V$ V_{CE} in OFF mode |
| Power Supply Rejection Ratio PSRR | | 70 | | dB | Ripple 0.5V _{p-p} , f=10kHz $V_{IN}=2.5V$ |
| Output Voltage Temperature Coefficient | | ± 150 | | $\mu V/^\circ C$ | • $\Delta V_{OUT}/\Delta T$ |
| | | ± 100 | | ppm/ $^\circ C$ | • $(\Delta V_{OUT}/V_{OUT})/\Delta T$ |
| Short Current Limit I_{LIMIT} | | 50 | | mA | $V_{OUT}=0V$ |
| RMS Output Noise V_{NOISE} | | 30 | | μV_{rms} | $T_A=25^\circ C$ $10Hz \leq f \leq 100kHz$ |
| CE "High" Voltage | 1.5 | | | V | CE input voltage "High" |
| CE "Low" Voltage | | | 0.25 | V | CE input voltage "Low" |
| CE Pull-down Resistance R_{PD} | 2.5 | 5 | 10 | M Ω | |

SP6260BEK (1.8V)

Unless otherwise indicated, $V_{IN} = 2.8V$, $C_{IN} = 1\mu F$, $C_{OUT} = 1\mu F$.

| Parameter | Min. | Typ. | Max. | Units | Conditions |
|--|-------|-----------|-------|------------------|---|
| Output Voltage V_{OUT} | 1.764 | 1.8 | 1.836 | V | $V_{IN}=2.8V$ $1mA \leq I_{OUT} \leq 30mA$ |
| Input Voltage V_{IN} | | | 6 | V | |
| Output Current I_{OUT} | 200 | | | mA | $V_{IN}-V_{OUT}=1V$ |
| Load Regulation V_{RLOAD} | | 12 | 40 | mV | $V_{IN}=2.8V$ $1mA \leq I_{OUT} \leq 80mA$ |
| Line Regulation V_{RLINE} | | 4 | 16 | mV | $2.3V \leq V_{IN} \leq 6V$ $I_{OUT}=30mA$ |
| Dropout Voltage V_{DROP} | | 20 | 40 | mV | $I_{OUT}=10mA$ |
| | | 150 | 300 | | $I_{OUT}=100mA$ |
| | | 200 | 400 | | $I_{OUT}=150mA$ |
| | | 250 | 500 | | $I_{OUT}=200mA$ |
| Quiescent Current I_Q | | 25 | 50 | μA | $V_{IN}=2.8V, I_{OUT}=0mA$ |
| Standby Current I_{STD} | | 0.1 | 1 | μA | $V_{IN}=2.8V$ V_{CE} in OFF mode |
| Power Supply Rejection Ratio PSRR | | 70 | | dB | Ripple 0.5V _{p-p} , f=10kHz $V_{IN}=2.5V$ |
| Output Voltage Temperature Coefficient | | ± 180 | | $\mu V/^\circ C$ | • $\Delta V_{OUT}/\Delta T$ |
| | | ± 100 | | ppm/ $^\circ C$ | • $(\Delta V_{OUT}/V_{OUT})/\Delta T$ |



200mA RF Low Noise LDO Regulator

| | | | | | |
|----------------------------------|-----|----|------|---------------|--|
| Short Current Limit I_{LIMIT} | | 50 | | mA | $V_{OUT}=0V$ |
| RMS Output Noise V_{NOISE} | | 30 | | μV_{rms} | $T_A=25^{\circ}C$ $10Hz \leq f \leq 100kHz$ |
| CE "High" Voltage | 1.5 | | | V | CE input voltage "High" |
| CE "Low" Voltage | | | 0.25 | V | CE input voltage "Low" |
| CE Pull-down Resistance R_{PD} | 2.5 | 5 | 10 | $M\Omega$ | |

SP6260CEK (2.5V)

Unless otherwise indicated, $V_{IN} = 3.5V$, $C_{IN} = 1\mu F$, $C_{OUT} = 1\mu F$.

| Parameter | Min. | Typ. | Max. | Units | Conditions |
|--|------|-----------|------|-------------------|---|
| Output Voltage V_{OUT} | 2.45 | 2.5 | 2.55 | V | $V_{IN}=3.5V$ $1mA \leq I_{OUT} \leq 30mA$ |
| Input Voltage V_{IN} | | | 6 | V | |
| Output Current I_{OUT} | 200 | | | mA | $V_{IN}-V_{OUT}=1V$ |
| Load Regulation V_{RLOAD} | | 12 | 40 | mV | $V_{IN}=3.5V$ $1mA \leq I_{OUT} \leq 80mA$ |
| Line Regulation V_{RLINE} | | 4 | 16 | mV | $3.0V \leq V_{IN} \leq 6V$ $I_{OUT}=30mA$ |
| Dropout Voltage V_{DROP} | | 20 | 40 | mV | $I_{OUT}=10mA$ |
| | | 150 | 300 | | $I_{OUT}=100mA$ |
| | | 200 | 400 | | $I_{OUT}=150mA$ |
| | | 250 | 500 | | $I_{OUT}=200mA$ |
| Quiescent Current I_Q | | 25 | 50 | μA | $V_{IN}=3.5V, I_{OUT}=0mA$ |
| Standby Current I_{STD} | | 0.1 | 1 | μA | $V_{IN}=3.5V$ V_{CE} in OFF mode |
| Power Supply Rejection Ratio PSRR | | 70 | | dB | Ripple 0.5V _{p-p} , $f=10kHz$ $V_{IN}=2.5V$ |
| Output Voltage Temperature Coefficient | | ± 250 | | $\mu V/^{\circ}C$ | $\Delta V_{OUT}/\Delta T$ |
| | | ± 100 | | ppm/ $^{\circ}C$ | $(\Delta V_{OUT}/V_{OUT})/\Delta T$ |
| Short Current Limit I_{LIMIT} | | 50 | | mA | $V_{OUT}=0V$ |
| RMS Output Noise V_{NOISE} | | 30 | | μV_{rms} | $T_A=25^{\circ}C$ $10Hz \leq f \leq 100kHz$ |
| CE "High" Voltage | 1.5 | | | V | CE input voltage "High" |
| CE "Low" Voltage | | | 0.25 | V | CE input voltage "Low" |
| CE Pull-down Resistance R_{PD} | 2.5 | 5 | 10 | $M\Omega$ | |

SP6260DEK (2.8V)

Unless otherwise indicated, $V_{IN} = 3.8V$, $C_{IN} = 1\mu F$, $C_{OUT} = 1\mu F$.

| Parameter | Min. | Typ. | Max. | Units | Conditions |
|-----------------------------|-------|------|-------|-------|---|
| Output Voltage V_{OUT} | 2.744 | 2.8 | 2.856 | V | $V_{IN}=3.8V$ $1mA \leq I_{OUT} \leq 30mA$ |
| Input Voltage V_{IN} | | | 6 | V | |
| Output Current I_{OUT} | 200 | | | mA | $V_{IN}-V_{OUT}=1V$ |
| Load Regulation V_{RLOAD} | | 12 | 40 | mV | $V_{IN}=3.8V$ $1mA \leq I_{OUT} \leq 80mA$ |
| Line Regulation V_{RLINE} | | 4 | 16 | mV | $3.3V \leq V_{IN} \leq 6V$ $I_{OUT}=30mA$ |
| Dropout Voltage V_{DROP} | | 20 | 40 | mV | $I_{OUT}=10mA$ |
| | | 150 | 300 | | $I_{OUT}=100mA$ |
| | | 200 | 400 | | $I_{OUT}=150mA$ |
| | | 250 | 500 | | $I_{OUT}=200mA$ |



| | | | | | |
|--|-----|-----------|------|------------------------------|---|
| Quiescent Current I_Q | | 25 | 50 | μA | $V_{IN}=3.8\text{V}, I_{OUT}=0\text{mA}$ |
| Standby Current I_{STD} | | 0.1 | 1 | μA | $V_{IN}=3.8\text{V}$ V_{CE} in OFF mode |
| Power Supply Rejection Ratio PSRR | | 70 | | dB | Ripple 0.5V_{p-p} , $f=10\text{kHz}$ $V_{IN}=2.5\text{V}$ |
| Output Voltage Temperature Coefficient | | ± 280 | | $\mu\text{V}/^\circ\text{C}$ | $\bullet \Delta V_{OUT}/\Delta T$ |
| | | ± 100 | | ppm/ $^\circ\text{C}$ | $\bullet (\Delta V_{OUT}/V_{OUT})/\Delta T$ |
| Short Current Limit I_{LIMIT} | | 50 | | mA | $V_{OUT}=0\text{V}$ |
| RMS Output Noise V_{NOISE} | | 30 | | μV_{rms} | $T_A=25^\circ\text{C}$ $10\text{Hz} \leq f \leq 100\text{kHz}$ |
| CE "High" Voltage | 1.5 | | | V | CE input voltage "High" |
| CE "Low" Voltage | | | 0.25 | V | CE input voltage "Low" |
| CE Pull-down Resistance R_{PD} | 2.5 | 5 | 10 | $\text{M}\Omega$ | |

SP6260EEK (3.0V)

Unless otherwise indicated, $V_{IN} = 4.0\text{V}$, $C_{IN} = 1\mu\text{F}$, $C_{OUT} = 1\mu\text{F}$.

| Parameter | Min. | Typ. | Max. | Units | Conditions |
|--|-------|-----------|-------|------------------------------|---|
| Output Voltage V_{OUT} | 2.940 | 3.0 | 3.060 | V | $V_{IN}=4.0\text{V}$ $1\text{mA} \leq I_{OUT} \leq 30\text{mA}$ |
| Input Voltage V_{IN} | | | 6 | V | |
| Output Current I_{OUT} | 200 | | | mA | $V_{IN}-V_{OUT}=1\text{V}$ |
| Load Regulation V_{RLOAD} | | 12 | 40 | mV | $V_{IN}=4.0\text{V}$ $1\text{mA} \leq I_{OUT} \leq 80\text{mA}$ |
| Line Regulation V_{RLINE} | | 4 | 16 | mV | $3.5\text{V} \leq V_{IN} \leq 6\text{V}$ $I_{OUT}=30\text{mA}$ |
| Dropout Voltage V_{DROP} | | 20 | 40 | mV | $I_{OUT}=10\text{mA}$ |
| | | 150 | 300 | | $I_{OUT}=100\text{mA}$ |
| | | 200 | 400 | | $I_{OUT}=150\text{mA}$ |
| | | 250 | 500 | | $I_{OUT}=200\text{mA}$ |
| Quiescent Current I_Q | | 25 | 50 | μA | $V_{IN}=4.0\text{V}, I_{OUT}=0\text{mA}$ |
| Standby Current I_{STD} | | 0.1 | 1 | μA | $V_{IN}=4.0\text{V}$ V_{CE} in OFF mode |
| Power Supply Rejection Ratio PSRR | | 70 | | dB | Ripple 0.5V_{p-p} , $f=10\text{kHz}$ $V_{IN}=2.5\text{V}$ |
| Output Voltage Temperature Coefficient | | ± 300 | | $\mu\text{V}/^\circ\text{C}$ | $\bullet \Delta V_{OUT}/\Delta T$ |
| | | ± 100 | | ppm/ $^\circ\text{C}$ | $\bullet (\Delta V_{OUT}/V_{OUT})/\Delta T$ |
| Short Current Limit I_{LIMIT} | | 50 | | mA | $V_{OUT}=0\text{V}$ |
| RMS Output Noise V_{NOISE} | | 30 | | μV_{rms} | $T_A=25^\circ\text{C}$ $10\text{Hz} \leq f \leq 100\text{kHz}$ |
| CE "High" Voltage | 1.5 | | | V | CE input voltage "High" |
| CE "Low" Voltage | | | 0.25 | V | CE input voltage "Low" |
| CE Pull-down Resistance R_{PD} | 2.5 | 5 | 10 | $\text{M}\Omega$ | |

SP6260FEK (3.2V)

Unless otherwise indicated, $V_{IN} = 4.2\text{V}$, $C_{IN} = 1\mu\text{F}$, $C_{OUT} = 1\mu\text{F}$.

| Parameter | Min. | Typ. | Max. | Units | Conditions |
|--------------------------|-------|------|-------|-------|--|
| Output Voltage V_{OUT} | 3.136 | 3.2 | 3.264 | V | $V_{IN}=4.2\text{V}$ $1\text{mA} \leq I_{OUT} \leq 30\text{mA}$ |
| Input Voltage V_{IN} | | | 6 | V | |
| Output Current I_{OUT} | 200 | | | mA | $V_{IN}-V_{OUT}=1\text{V}$ |



200mA RF Low Noise LDO Regulator

| | | | | | |
|--|-----|-----------|------|------------------|---|
| Load Regulation V_{RLOAD} | | 12 | 40 | mV | $V_{IN}=4.2V$ $1mA \leq I_{OUT} \leq 80mA$ |
| Line Regulation V_{RLINE} | | 4 | 16 | mV | $3.7V \leq V_{IN} \leq 6V$ $I_{OUT}=30mA$ |
| Dropout Voltage V_{DROP} | | 20 | 40 | mV | $I_{OUT}=10mA$ |
| | | 150 | 300 | | $I_{OUT}=100mA$ |
| | | 200 | 400 | | $I_{OUT}=150mA$ |
| | | 250 | 500 | | $I_{OUT}=200mA$ |
| Quiescent Current I_Q | | 25 | 50 | μA | $V_{IN}=4.2V, I_{OUT}=0mA$ |
| Standby Current I_{STD} | | 0.1 | 1 | μA | $V_{IN}=4.2V$ V_{CE} in OFF mode |
| Power Supply Rejection Ratio PSRR | | 70 | | dB | Ripple 0.5V _{p-p} , f=10kHz $V_{IN}=2.5V$ |
| Output Voltage Temperature Coefficient | | ± 320 | | $\mu V/^\circ C$ | • $\Delta V_{OUT}/\Delta T$ |
| | | ± 100 | | ppm/ $^\circ C$ | • $(\Delta V_{OUT}/V_{OUT})/\Delta T$ |
| Short Current Limit I_{LIMIT} | | 50 | | mA | $V_{OUT}=0V$ |
| RMS Output Noise V_{NOISE} | | 30 | | μV_{rms} | $T_A=25^\circ C$ $10Hz \leq f \leq 100kHz$ |
| CE "High" Voltage | 1.5 | | | V | CE input voltage "High" |
| CE "Low" Voltage | | | 0.25 | V | CE input voltage "Low" |
| CE Pull-down Resistance R_{PD} | 2.5 | 5 | 10 | M Ω | |

SP6260GEK (3.3V)

Unless otherwise indicated, $V_{IN} = 4.3V$, $C_{IN} = 1\mu F$, $C_{OUT} = 1\mu F$.

| Parameter | Min. | Typ. | Max. | Units | Conditions |
|--|-------|-----------|-------|------------------|---|
| Output Voltage V_{OUT} | 3.234 | 3.3 | 3.366 | V | $V_{IN}=4.3V$ $1mA \leq I_{OUT} \leq 30mA$ |
| Input Voltage V_{IN} | | | 6 | V | |
| Output Current I_{OUT} | 200 | | | mA | $V_{IN}-V_{OUT}=1V$ |
| Load Regulation V_{RLOAD} | | 12 | 40 | mV | $V_{IN}=4.3V$ $1mA \leq I_{OUT} \leq 80mA$ |
| Line Regulation V_{RLINE} | | 4 | 16 | mV | $3.8V \leq V_{IN} \leq 6V$ $I_{OUT}=30mA$ |
| Dropout Voltage V_{DROP} | | 20 | 40 | mV | $I_{OUT}=10mA$ |
| | | 150 | 300 | | $I_{OUT}=100mA$ |
| | | 200 | 400 | | $I_{OUT}=150mA$ |
| | | 250 | 500 | | $I_{OUT}=200mA$ |
| Quiescent Current I_Q | | 25 | 50 | μA | $V_{IN}=4.3V, I_{OUT}=0mA$ |
| Standby Current I_{STD} | | 0.1 | 1 | μA | $V_{IN}=4.3V$ V_{CE} in OFF mode |
| Power Supply Rejection Ratio PSRR | | 70 | | dB | Ripple 0.5V _{p-p} , f=10kHz $V_{IN}=2.5V$ |
| Output Voltage Temperature Coefficient | | ± 330 | | $\mu V/^\circ C$ | • $\Delta V_{OUT}/\Delta T$ |
| | | ± 100 | | ppm/ $^\circ C$ | • $(\Delta V_{OUT}/V_{OUT})/\Delta T$ |
| Short Current Limit I_{LIMIT} | | 50 | | mA | $V_{OUT}=0V$ |
| RMS Output Noise V_{NOISE} | | 30 | | μV_{rms} | $T_A=25^\circ C$ $10Hz \leq f \leq 100kHz$ |
| CE "High" Voltage | 1.5 | | | V | CE input voltage "High" |
| CE "Low" Voltage | | | 0.25 | V | CE input voltage "Low" |
| CE Pull-down Resistance R_{PD} | 2.5 | 5 | 10 | M Ω | |

BLOCK DIAGRAM

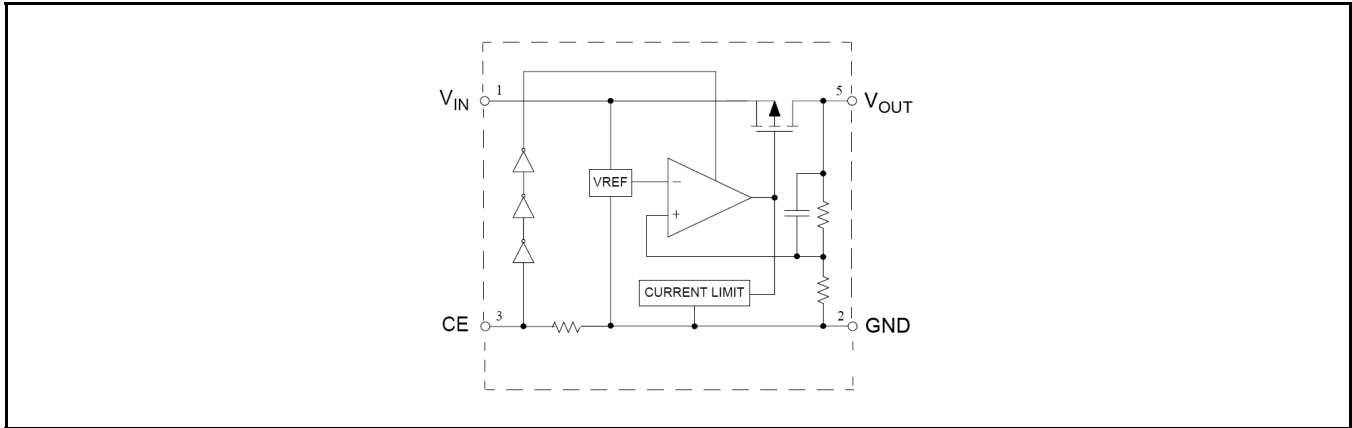

Fig. 2: SP6260 Block Diagram

PIN ASSIGNMENT

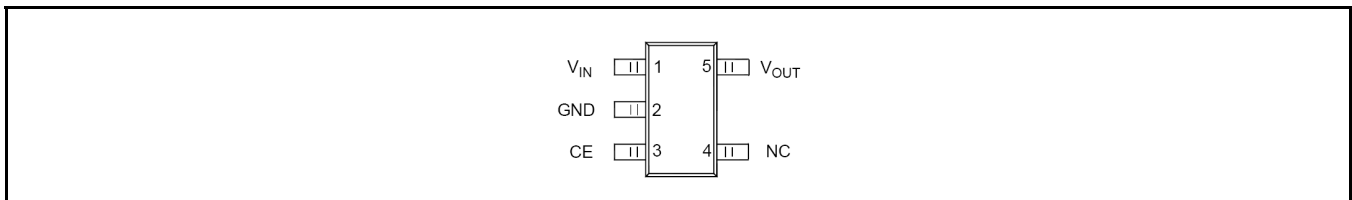

Fig. 3: SP6260 Pin Assignment

PIN DESCRIPTION

| Name | Pin Number | Description |
|-----------|------------|--|
| V_{IN} | 1 | Input voltage |
| GND | 2 | Ground |
| CE | 3 | Enable input pin. high=enable low=shutdown |
| NC | 4 | No connection |
| V_{OUT} | 5 | Regulated output voltage |

ORDERING INFORMATION

| Part Number | Junction Temperature Range | Marking | Package | Packing Quantity | Note 1 | Note 2 |
|----------------|----------------------------|---------|----------|------------------|-----------|--------------|
| SP6260HEK-L/TR | -40°C to +85°C | CCWW | SOT-23-5 | 3K/Tape & Reel | Lead Free | 1.2V version |
| SP6260AEK-L/TR | -40°C to +85°C | DBWW | SOT-23-5 | 3K/Tape & Reel | Lead Free | 1.5V version |
| SP6260BEK-L/TR | -40°C to +85°C | EBWW | SOT-23-5 | 3K/Tape & Reel | Lead Free | 1.8V version |
| SP6260CEK-L/TR | -40°C to +85°C | FBWW | SOT-23-5 | 3K/Tape & Reel | Lead Free | 2.5V version |
| SP6260DEK-L/TR | -40°C to +85°C | GBWW | SOT-23-5 | 3K/Tape & Reel | Lead Free | 2.8V version |
| SP6260EEK-L/TR | -40°C to +85°C | HBWW | SOT-23-5 | 3K/Tape & Reel | Lead Free | 3.0V version |
| SP6260FEK-L/TR | -40°C to +85°C | JBWW | SOT-23-5 | 3K/Tape & Reel | Lead Free | 3.2V version |
| SP6260GEK-L/TR | -40°C to +85°C | KBWW | SOT-23-5 | 3K/Tape & Reel | Lead Free | 3.3V version |

"WW" = Work Week

TYPICAL PERFORMANCE CHARACTERISTICS

All data taken at $V_{IN} = 2.7V$ to $5.5V$, $T_J = T_A = 25^\circ C$, unless otherwise specified - Schematic and BOM from Application Information section of this datasheet.

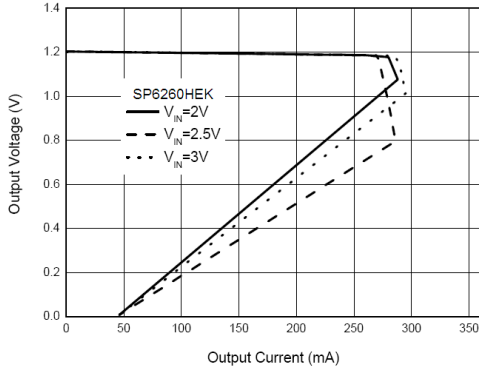

Fig. 4: Output Voltage vs. Output Current SP6260HEK (1.2V)

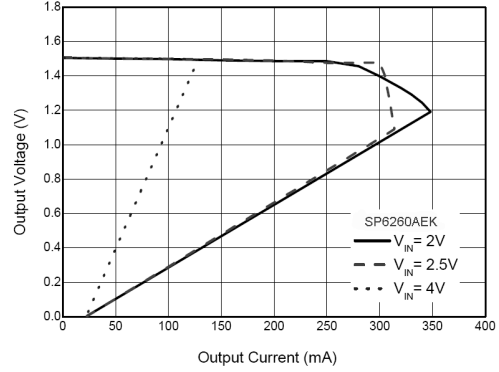

Fig. 5: Output Voltage vs. Output Current SP6260AEK (1.5V)

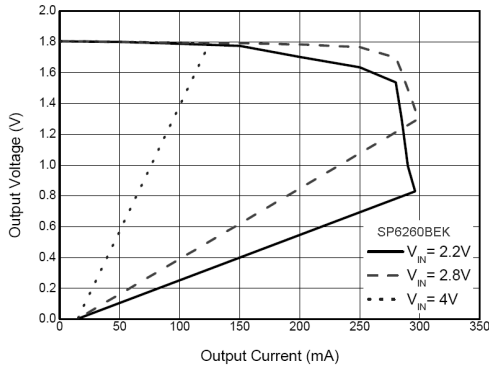

Fig. 6: Output Voltage vs. Output Current SP6260BEK (1.8V)

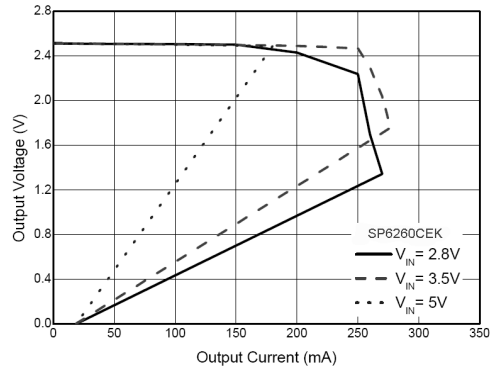

Fig. 7: Output Voltage vs. Output Current SP6260CEK (2.5V)

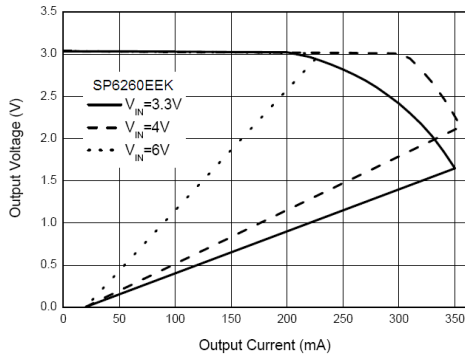

Fig. 8: Output Voltage vs. Output Current SP6260EEK (3.0V)

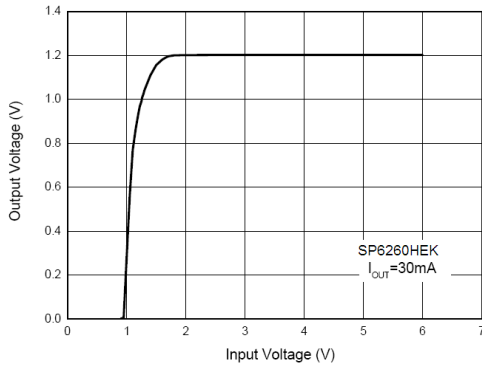

Fig. 9: Output Voltage vs. Input Voltage
SP6260HEK (1.2V)

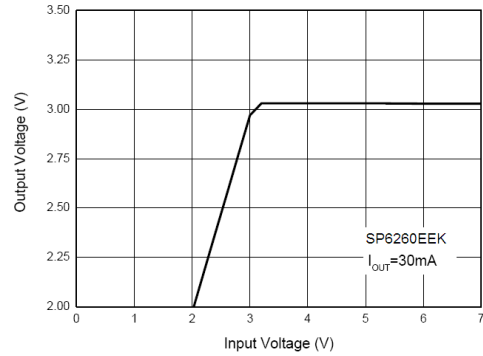

Fig. 10: Output Voltage vs. Input Voltage
SP6260EEK (3.0V)

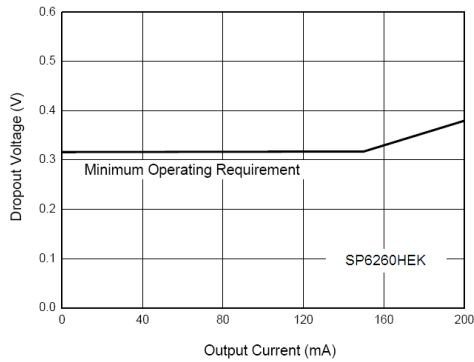

Fig. 11: Dropout Voltage vs. Output Current
SP6260HEK-L (1.2V)

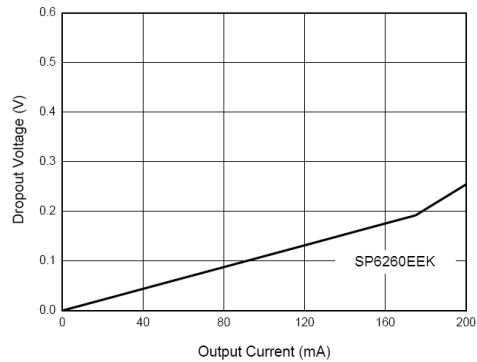

Fig. 12: Dropout Voltage vs. Output Current
SP6260EEK-L (3.0V)

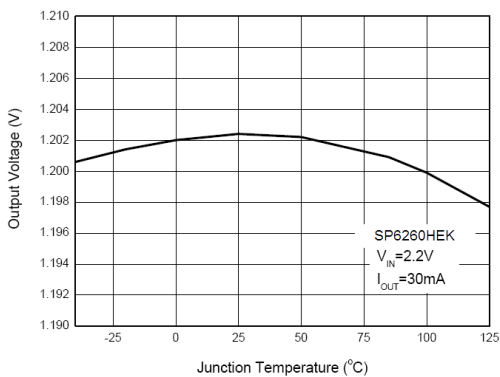

Fig. 13: Output Voltage vs. Junction Temperature
SP6260HEK-L (1.2V)

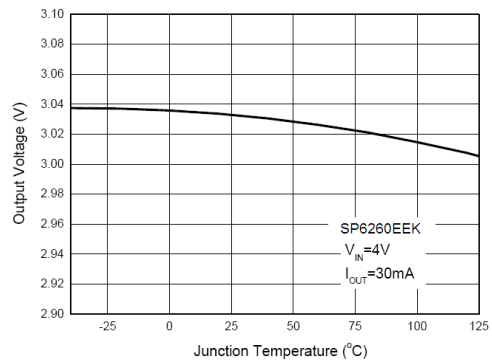

Fig. 14: Output Voltage vs. Junction Temperature
SP6260EEK-L (3.0V)

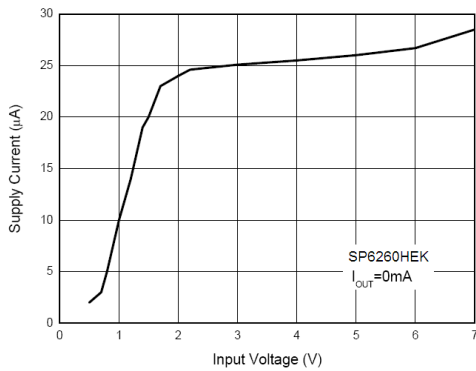

Fig. 15: Supply Current vs. Input Voltage SP6260HEK (1.2V)

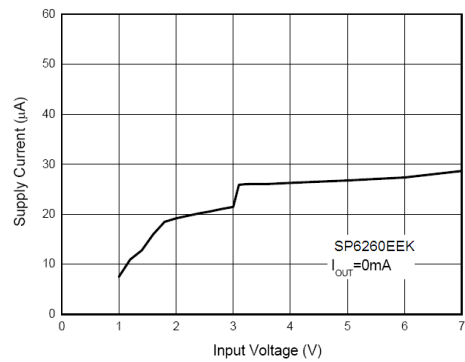

Fig. 16: Supply Current vs. Input Voltage SP6260EEK (3.0V)

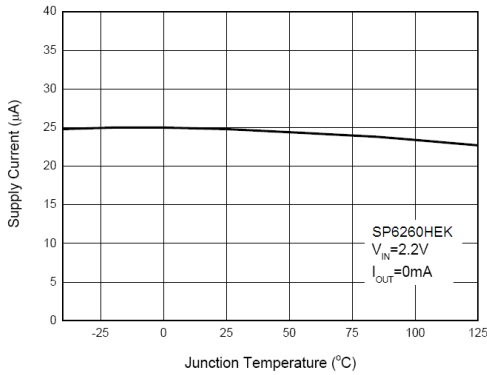

Fig. 17: Supply Current vs. Junction Temperature SP6260HEK (1.2V)

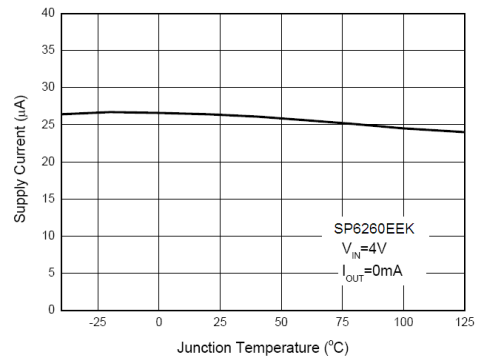

Fig. 18: Supply Current vs. Junction Temperature SP6260EEK (3.0V)

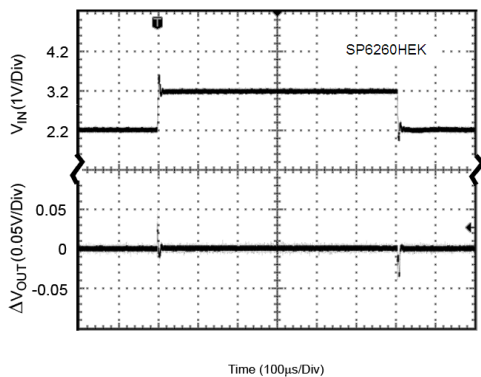

Fig. 19: Line Transient SP6260HEK (1.2V)
(Conditions: $I_{OUT}=30\text{mA}$, $C_{IN}=1\mu\text{F}$, $C_{OUT}=1\mu\text{F}$)

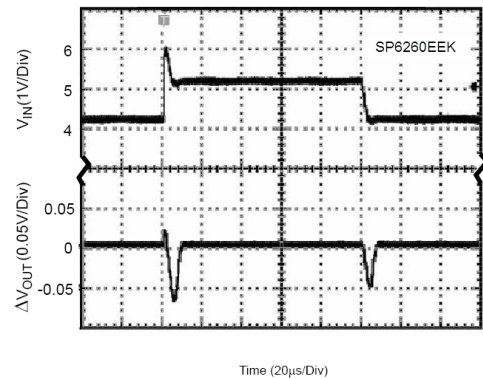

Fig. 20: Line Transient SP6260EEK (3.0V)
(Conditions: $I_{OUT}=30\text{mA}$, $C_{IN}=1\mu\text{F}$, $C_{OUT}=1\mu\text{F}$)

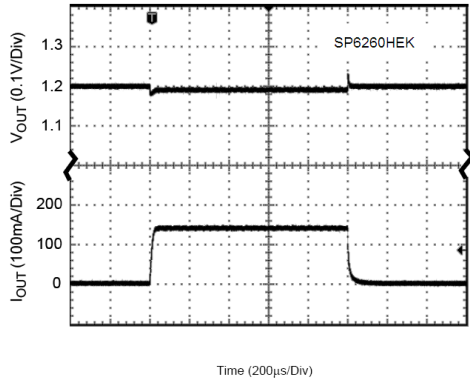

Fig. 21: Line Transient SP6260HEK (1.2V)
 (Conditions: $V_{IN}=2.5V$, $C_{IN}=1\mu F$, $C_{OUT}=1\mu F$)

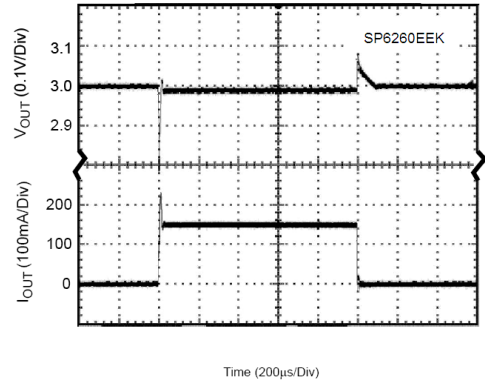

Fig. 22: Line Transient SP6260EEK (3.0V)
 (Conditions: $V_{IN}=4V$, $C_{IN}=1\mu F$, $C_{OUT}=1\mu F$)

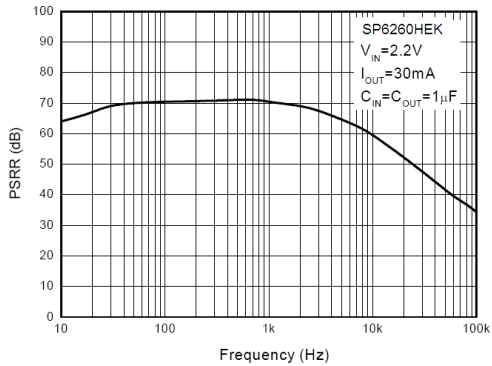

Fig. 23: PSRR vs. Frequency
 SP6260HEK (1.2V)

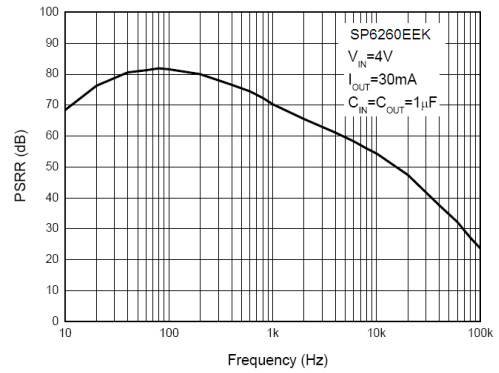
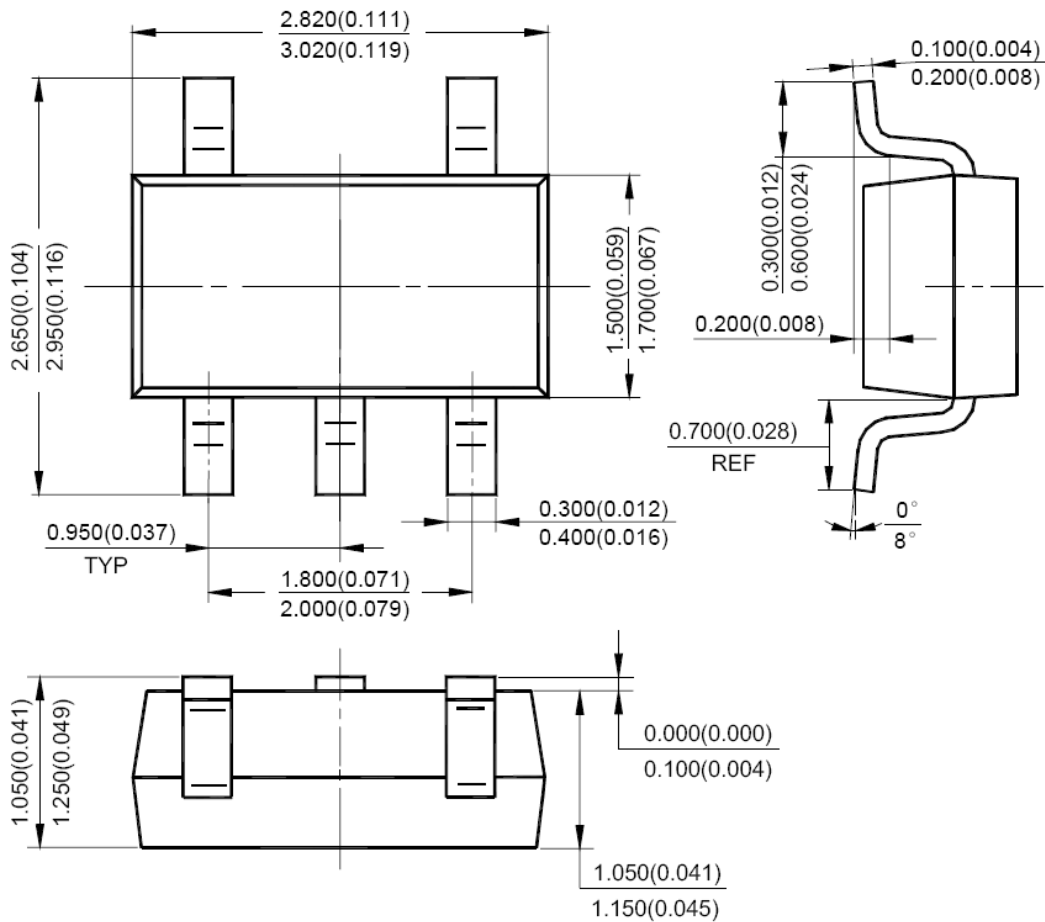

Fig. 21: PSRR vs. Frequency
 SP6260EEK (3.0V)

PACKAGE SPECIFICATION

5-PIN SOT-23

Unit: mm (inch)





REVISION HISTORY

| Revision | Date | Description |
|----------|------------|---|
| 0.1 | | Initial Data Sheet |
| 2.0.0 | 10/27/2010 | Reformat of datasheet Increased output current capabilities to 200mA Removal of 1.5V version curves Addition of the 1.2V version data and curves |
| 2.1.0 | 01/26/2011 | Corrected Electrical tables V_{OUT} range for SP6260E, SP6260F and SP6260G Addition of "Output Current vs Output Voltage" curves figures 5, 6 and 7. |

FOR FURTHER ASSISTANCE

Email: customersupport@exar.com
Exar Technical Documentation: <http://www.exar.com/TechDoc/default.aspx?>

EXAR CORPORATION

HEADQUARTERS AND SALES OFFICES

48720 Kato Road
Fremont, CA 94538 – USA
Tel.: +1 (510) 668-7000
Fax: +1 (510) 668-7030
www.exar.com



NOTICE

EXAR Corporation reserves the right to make changes to the products contained in this publication in order to improve design, performance or reliability. EXAR Corporation assumes no responsibility for the use of any circuits described herein, conveys no license under any patent or other right, and makes no representation that the circuits are free of patent infringement. Charts and schedules contained here in are only for illustration purposes and may vary depending upon a user's specific application. While the information in this publication has been carefully checked; no responsibility, however, is assumed for inaccuracies.

EXAR Corporation does not recommend the use of any of its products in life support applications where the failure or malfunction of the product can reasonably be expected to cause failure of the life support system or to significantly affect its safety or effectiveness. Products are not authorized for use in such applications unless EXAR Corporation receives, in writing, assurances to its satisfaction that: (a) the risk of injury or damage has been minimized; (b) the user assumes all such risks; (c) potential liability of EXAR Corporation is adequately protected under the circumstances.

Reproduction, in part or whole, without the prior written consent of EXAR Corporation is prohibited.



Компания «ЭлектроПласт» предлагает заключение долгосрочных отношений при поставках импортных электронных компонентов на взаимовыгодных условиях!

Наши преимущества:

- Оперативные поставки широкого спектра электронных компонентов отечественного и импортного производства напрямую от производителей и с крупнейших мировых складов;
- Поставка более 17-ти миллионов наименований электронных компонентов;
- Поставка сложных, дефицитных, либо снятых с производства позиций;
- Оперативные сроки поставки под заказ (от 5 рабочих дней);
- Экспресс доставка в любую точку России;
- Техническая поддержка проекта, помощь в подборе аналогов, поставка прототипов;
- Система менеджмента качества сертифицирована по Международному стандарту ISO 9001;
- Лицензия ФСБ на осуществление работ с использованием сведений, составляющих государственную тайну;
- Поставка специализированных компонентов (Xilinx, Altera, Analog Devices, Intersil, Interpoint, Microsemi, Aeroflex, Peregrine, Syfer, Eurofarad, Texas Instrument, Miteq, Cobham, E2V, MA-COM, Hittite, Mini-Circuits, General Dynamics и др.);

Помимо этого, одним из направлений компании «ЭлектроПласт» является направление «Источники питания». Мы предлагаем Вам помощь Конструкторского отдела:

- Подбор оптимального решения, техническое обоснование при выборе компонента;
- Подбор аналогов;
- Консультации по применению компонента;
- Поставка образцов и прототипов;
- Техническая поддержка проекта;
- Защита от снятия компонента с производства.



Как с нами связаться

Телефон: 8 (812) 309 58 32 (многоканальный)

Факс: 8 (812) 320-02-42

Электронная почта: org@eplast1.ru

Адрес: 198099, г. Санкт-Петербург, ул. Калинина, дом 2, корпус 4, литера А.