

Features

- Glass Passivated Die Construction
- Diffused Junction
- Fast Switching for High Efficiency
- High Current Capability and Low Forward Voltage Drop
- Surge Overload Rating to 30A Peak
- **Lead Free Finish, RoHS Compliant (Note 4)**

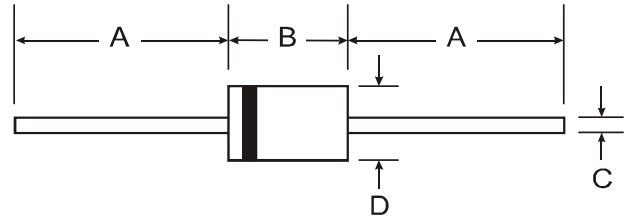

Mechanical Data

- Case: DO-41
- Case Material: Molded Plastic. UL Flammability Classification Rating 94V-0
- Moisture Sensitivity: Level 1 per J-STD-020D
- Terminals: Finish - Bright Tin. Plated Leads Solderable per MIL-STD-202, Method 208 **(e3)**
- Polarity: Cathode Band
- Ordering Information: See Page 3
- Marking: Type Number
- Weight: 0.35 grams (approximate)

Dim	DO-41	
	Min	Max
A	25.40	—
B	4.06	5.21
C	0.71	0.864
D	2.00	2.72
All Dimensions in mm		

Maximum Ratings and Electrical Characteristics

@T_A = 25°C unless otherwise specified

Single phase, half wave, 60Hz, resistive or inductive load.
For capacitive load, derate current by 20%.

Characteristic	Symbol	1N4933G	1N4934G	1N4935G	1N4936G	1N4937G	Unit
Peak Repetitive Reverse Voltage	V _{RRM}	50	100	200	400	600	V
Working Peak Reverse Voltage	V _{RWM}						
DC Blocking Voltage	V _R						
RMS Reverse Voltage	V _{R(RMS)}	35	70	140	280	420	V
Average Rectified Output Current (Note 1) @ T _A = 75°C	I _O	1.0					A
Non-Repetitive Peak Forward Surge Current 8.3ms Single Half Sine-Wave Superimposed on Rated Load	I _{FSM}	30					A
Forward Voltage @ I _F = 1.0A	V _{FM}	1.2					V
Peak Reverse Current @ T _A = 25°C at Rated DC Blocking Voltage @ T _A = 100°C	I _{RM}	5.0 100					μA
Reverse Recovery Time (Note 3)	t _{rr}	200					ns
Typical Junction Capacitance (Note 2)	C _j	15					pF
Typical Thermal Resistance Junction to Ambient	R _{θJA}	100					K/W
Operating and Storage Temperature Range	T _J , T _{STG}	-65 to +150					°C

- Notes:
1. Valid provided that leads are maintained at ambient temperature at a distance of 9.5mm from the case.
 2. Measured at 1.0MHz and applied reverse voltage of 4.0V DC.
 3. Measured with I_F = 0.5A, I_R = 1.0A, I_{rr} = 0.25A.
 4. EU Directive 2002/95/EC (RoHS). All applicable RoHS exemptions applied, see EU Directive 2002/95/EC Annex Notes.

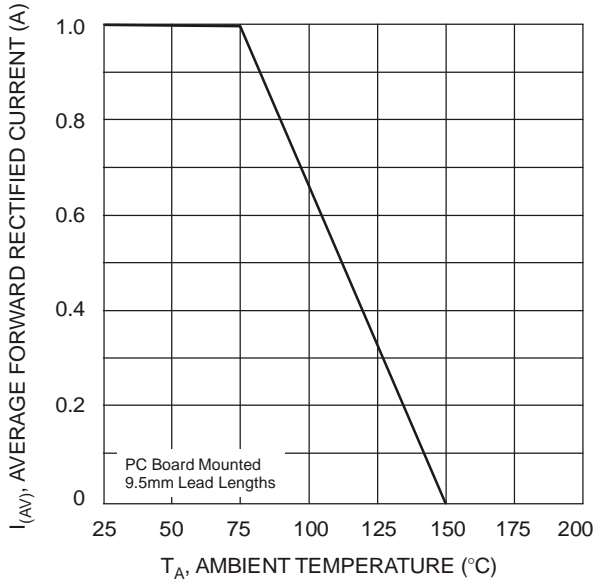

Fig. 1 Forward Current Derating Curves

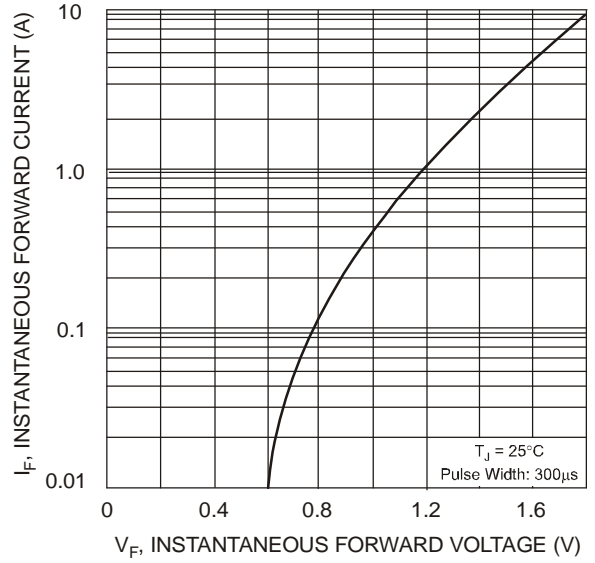

Fig. 2 Typical Forward Characteristics

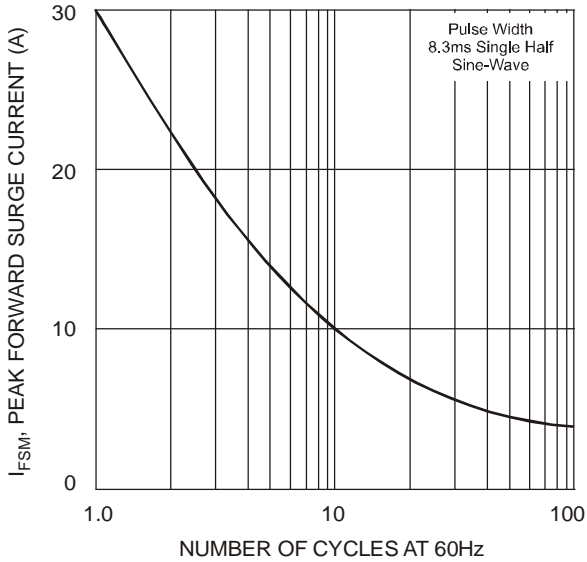

Fig. 3 Max Non-Repetitive Peak Forward Surge Current

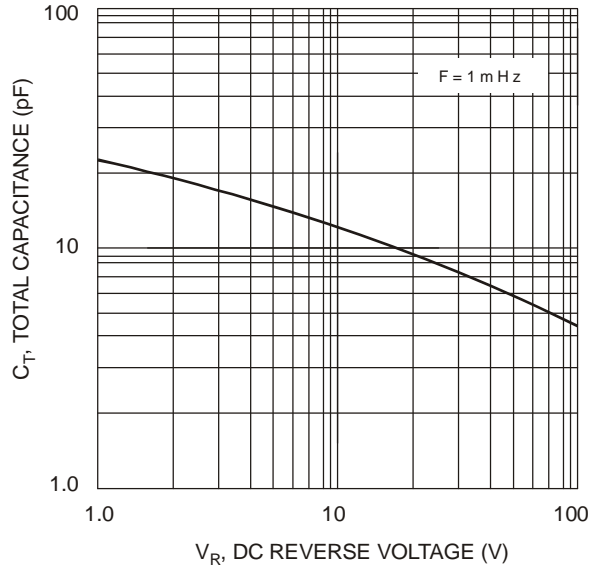
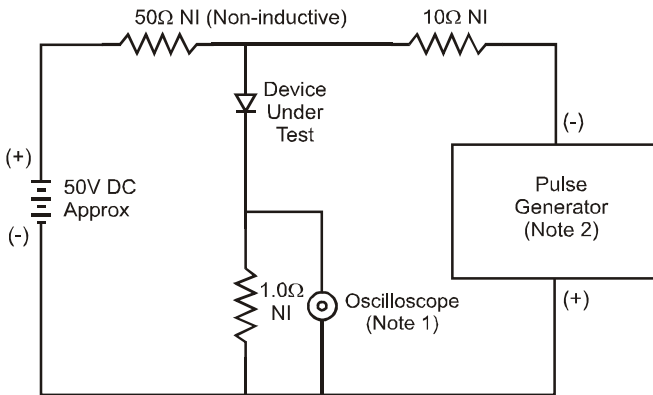
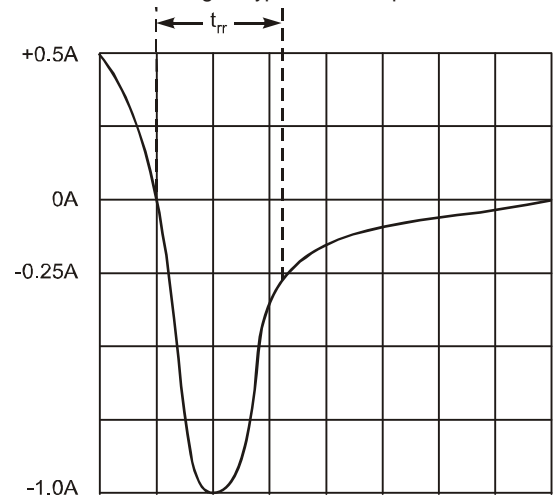

Fig. 4 Typical Total Capacitance



- Notes:
1. Rise Time = 7.0ns max. Input Impedance = 1.0MΩ, 22pF.
 2. Rise Time = 10ns max. Input Impedance = 50Ω.



Set time base for 50/100 ns/cm

Fig. 5 Reverse Recovery Time Characteristic and Test Circuit



Ordering Information (Note 5)

Device	Packaging	Shipping
1N4933G-T	DO-41	5K/Tape & Reel, 13-inch
1N4934G-T	DO-41	5K/Tape & Reel, 13-inch
1N4935G-T	DO-41	5K/Tape & Reel, 13-inch
1N4936G-T	DO-41	5K/Tape & Reel, 13-inch
1N4937G-T	DO-41	5K/Tape & Reel, 13-inch

Notes: 5. For packaging details, visit our website at <http://www.diodes.com/datasheets/ap02008.pdf>.

IMPORTANT NOTICE

Diodes Incorporated and its subsidiaries reserve the right to make modifications, enhancements, improvements, corrections or other changes without further notice to any product herein. Diodes Incorporated does not assume any liability arising out of the application or use of any product described herein; neither does it convey any license under its patent rights, nor the rights of others. The user of products in such applications shall assume all risks of such use and will agree to hold Diodes Incorporated and all the companies whose products are represented on our website, harmless against all damages.

LIFE SUPPORT

Diodes Incorporated products are not authorized for use as critical components in life support devices or systems without the expressed written approval of the President of Diodes Incorporated.



Компания «ЭлектроПласт» предлагает заключение долгосрочных отношений при поставках импортных электронных компонентов на взаимовыгодных условиях!

Наши преимущества:

- Оперативные поставки широкого спектра электронных компонентов отечественного и импортного производства напрямую от производителей и с крупнейших мировых складов;
- Поставка более 17-ти миллионов наименований электронных компонентов;
- Поставка сложных, дефицитных, либо снятых с производства позиций;
- Оперативные сроки поставки под заказ (от 5 рабочих дней);
- Экспресс доставка в любую точку России;
- Техническая поддержка проекта, помощь в подборе аналогов, поставка прототипов;
- Система менеджмента качества сертифицирована по Международному стандарту ISO 9001;
- Лицензия ФСБ на осуществление работ с использованием сведений, составляющих государственную тайну;
- Поставка специализированных компонентов (Xilinx, Altera, Analog Devices, Intersil, Interpoint, Microsemi, Aeroflex, Peregrine, Syfer, Eurofarad, Texas Instrument, Miteq, Cobham, E2V, MA-COM, Hittite, Mini-Circuits, General Dynamics и др.);

Помимо этого, одним из направлений компании «ЭлектроПласт» является направление «Источники питания». Мы предлагаем Вам помощь Конструкторского отдела:

- Подбор оптимального решения, техническое обоснование при выборе компонента;
- Подбор аналогов;
- Консультации по применению компонента;
- Поставка образцов и прототипов;
- Техническая поддержка проекта;
- Защита от снятия компонента с производства.



Как с нами связаться

Телефон: 8 (812) 309 58 32 (многоканальный)

Факс: 8 (812) 320-02-42

Электронная почта: org@eplast1.ru

Адрес: 198099, г. Санкт-Петербург, ул. Калинина, дом 2, корпус 4, литера А.