

Cree® XLamp® XP-G2 LEDs



XP-G2 Standard LED



XP-G2 High Efficacy LED

PRODUCT DESCRIPTION

The original XLamp® XP-G2 LED pioneered a broad set of LED applications for the industry, including outdoor and area lighting, and has since served as a preferred choice by manufacturers that require advanced output, efficacy and optical control. The compact and proven 3.45-mm XP platform has an excellent ecosystem of optics and system solutions available, enabling lighting manufacturers to simplify their design process and shorten time to market.

XP-G2 LEDs are now available in two different White versions: Standard and High Efficacy (HE). XP-G2 Standard is the same breakthrough product that enabled a broad set of new LED applications for ceramic high-power LEDs.

The new High Efficacy version extends this legacy with a drop-in upgrade for existing designs optimized around XP-G2 LEDs. XP-G2 HE LEDs leverage Cree's latest high-power chip technology to deliver 25 percent more light output via a higher maximum current of 2000 mA and higher efficacy and lower thermal resistance.

FEATURES

- Available in white, outdoor white and 80-, 85- and 90-CRI white
- ANSI-compatible chromaticity bins
- Binned at 85 °C
- Maximum drive current: Standard: 1500 mA, HE: 2000 mA
- Low thermal resistance: Standard: 4 °C/W, HE: 3 °C/W
- Wide viewing angle: Standard: 120°, HE: 125°
- Unlimited floor life at ≤ 30 °C/85% RH
- Reflow solderable - JEDEC J-STD-020C
- Electrically neutral thermal path
- RoHS and REACH compliant
- UL® recognized component (E349212)



TABLE OF CONTENTS

Characteristics	3
Flux Characteristics - High Efficacy	4
Flux Characteristics - Standard	9
Relative Spectral Power Distribution	15
Relative Flux vs. Junction Temperature.....	15
Electrical Characteristics - High Efficacy.....	16
Electrical Characteristics - Standard	16
Relative Flux vs. Current - High Efficacy.....	17
Relative Flux vs. Current - Standard	17
Relative Chromaticity vs Current and Temperature - High Efficacy.....	18
Relative Chromaticity vs Current and Temperature - Standard.....	19
Typical Spatial Distribution - High Efficacy.....	20
Typical Spatial Distribution - Standard	20
Thermal Design - High Efficacy.....	21
Thermal Design - Standard.....	21
Performance Groups – Luminous Flux.....	22
Performance Groups – Chromaticity.....	23
Cree’s Standard Cool White Kits Plotted on ANSI Standard Chromaticity Regions.....	26
Cree’s Standard Warm and Neutral White Kits Plotted on ANSI Standard Chromaticity Regions.....	28
Cree’s Standard Chromaticity Kits	30
Bin and Order Code Formats.....	31
Reflow Soldering Characteristics.....	32
Notes	33
Mechanical Dimensions	35
Tape and Reel.....	37
Packaging.....	38

CHARACTERISTICS

Characteristics	Unit	Minimum	Typical	Maximum
Thermal resistance, junction to solder point - High Efficacy	°C/W		3	
Thermal resistance, junction to solder point - Standard	°C/W		4	
Viewing angle (FWHM) - High Efficacy	degrees		125	
Viewing angle (FWHM) - Standard	degrees		120	
Temperature coefficient of voltage - High Efficacy	mV/°C		-1.3	
Temperature coefficient of voltage - Standard	mV/°C		-1.4	
ESD withstand voltage (HBM per Mil-Std-883D)	V			8000
DC forward current - High Efficacy	mA			2000
DC forward current - Standard	mA			1500
Reverse voltage	V			5
Forward voltage (@ 350 mA, 85 °C) - High Efficacy	V		2.70	2.90
Forward voltage (@ 350 mA, 85 °C) - Standard	V		2.74	3.1
Forward voltage (@ 700 mA, 85 °C) - High Efficacy	V		2.80	
Forward voltage (@ 700 mA, 85 °C) - Standard	V		2.85	
Forward voltage (@ 1000 mA, 85 °C) - High Efficacy	V		2.87	
Forward voltage (@ 1000 mA, 85 °C) - Standard	V		2.93	
Forward voltage (@ 1500 mA, 85 °C) - High Efficacy	V		2.97	
Forward voltage (@ 1500 mA, 85 °C) - Standard	V		3.1	
LED junction temperature	°C			150

FLUX CHARACTERISTICS - HIGH EFFICACY ($T_j = 85^\circ\text{C}$)

The following table provides order codes for XLamp High-Efficacy XP-G2 LEDs. For a complete description of the order code nomenclature, please see the Bin and Order Code Formats section (page 31). For definitions of the chromaticity kits, please see the Cree's Standard Chromaticity Kits section (page 30).

Chromaticity		Minimum Luminous Flux (lm) @ 350 mA			Order Codes		
Kit	CCT	Code	Flux (lm) @ 85 °C	Flux (lm) @ 25 °C*	70 CRI Minimum	80 CRI Minimum	90 CRI Minimum
DT	7000 K	S4	164	180	XPGBWT-BE-0000-00LDT		
		S3	156	171	XPGBWT-BE-0000-00KDT	XPGBWT-HE-0000-00KDT	
		S2	148	163	XPGBWT-BE-0000-00JDT	XPGBWT-HE-0000-00JDT	
		R5	139	153		XPGBWT-HE-0000-00HDT	
E1	6500 K	S4	164	180	XPGBWT-BE-0000-00LE1		
		S3	156	171	XPGBWT-BE-0000-00KE1	XPGBWT-HE-0000-00KE1	
		S2	148	163	XPGBWT-BE-0000-00JE1	XPGBWT-HE-0000-00JE1	
		R5	139	153		XPGBWT-HE-0000-00HE1	
51	6200 K	S4	164	180	XPGBWT-BE-0000-00L51		
		S3	156	171	XPGBWT-BE-0000-00K51	XPGBWT-HE-0000-00K51	
		S2	148	163	XPGBWT-BE-0000-00J51	XPGBWT-HE-0000-00J51	
		R5	139	153		XPGBWT-HE-0000-00H51	
		R4	130	143			
		R3	122	134			XPGBWT-UE-0000-00F51
		R2	114	125			XPGBWT-UE-0000-00E51
DV	6000 K	S4	164	180	XPGBWT-BE-0000-00LDV		
		S3	156	171	XPGBWT-BE-0000-00KDV	XPGBWT-HE-0000-00KDV	
		S2	148	163	XPGBWT-BE-0000-00JDV	XPGBWT-HE-0000-00JDV	
		R5	139	153		XPGBWT-HE-0000-00HDV	
		R4	130	143			
		R3	122	134			XPGBWT-UE-0000-00FDV
		R2	114	125			XPGBWT-UE-0000-00EDV

Notes

- Cree maintains a tolerance of $\pm 7\%$ on flux and power measurements, ± 0.005 on chromaticity (CCx, CCy) measurements and a tolerance of ± 2 on CRI measurements. See the Measurements section (page 33).
- Cree XLamp XP-G2 LED order codes specify only a minimum flux bin and not a maximum. Cree may ship reels in flux bins higher than the minimum specified by the order code without advance notice. Shipments will always adhere to the chromaticity bin restrictions specified by the order code.
- * Flux values @ 25 °C are calculated and for reference only.

FLUX CHARACTERISTICS - HIGH EFFICACY (T_J = 85 °C) - CONTINUED

Chromaticity		Minimum Luminous Flux (lm) @ 350 mA			Order Codes		
Kit	CCT	Code	Flux (lm) @ 85 °C	Flux (lm) @ 25 °C*	70 CRI Minimum	80 CRI Minimum	90 CRI Minimum
50	6000 K	S4	164	180	XPGBWT-BE-0000-00L50		
		S3	156	171	XPGBWT-BE-0000-00K50	XPGBWT-HE-0000-00K50	
		S2	148	163	XPGBWT-BE-0000-00J50	XPGBWT-HE-0000-00J50	
		R5	139	153		XPGBWT-HE-0000-00H50	
		R4	130	143			
		R3	122	134			XPGBWT-UE-0000-00F50
		R2	114	125			XPGBWT-UE-0000-00E50
E2	5700 K	S4	164	180	XPGBWT-BE-0000-00LE2		
		S3	156	171	XPGBWT-BE-0000-00KE2	XPGBWT-HE-0000-00KE2	
		S2	148	163	XPGBWT-BE-0000-00JE2	XPGBWT-HE-0000-00JE2	
		R5	139	153		XPGBWT-HE-0000-00HE2	
		R4	130	143			XPGBWT-UE-0000-00GE2
		R3	122	134			XPGBWT-UE-0000-00FE2
		R2	114	125			XPGBWT-UE-0000-00EE2
E3	5000 K	S4	164	180	XPGBWT-BE-0000-00LE3		
		S3	156	171	XPGBWT-BE-0000-00KE3	XPGBWT-HE-0000-00KE3	
		S2	148	163	XPGBWT-BE-0000-00JE3	XPGBWT-HE-0000-00JE3	
		R5	139	153		XPGBWT-HE-0000-00HE3	
		R4	130	143			
		R3	122	134			XPGBWT-UE-0000-00FE3
		R2	114	125			XPGBWT-UE-0000-00EE3
F4	4750 K	S4	164	180	XPGBWT-BE-0000-00LF4		
		S3	156	171	XPGBWT-BE-0000-00KF4	XPGBWT-HE-0000-00KF4	
		S2	148	163	XPGBWT-BE-0000-00JF4	XPGBWT-HE-0000-00JF4	
		R5	139	153		XPGBWT-HE-0000-00HF4	
		R4	130	143			
		R3	122	134			XPGBWT-UE-0000-00FF4
		R2	114	125			XPGBWT-UE-0000-00EF4
		Q5	107	118			XPGBWT-UE-0000-00DF4

Notes

- Cree maintains a tolerance of ±7% on flux and power measurements, ±0.005 on chromaticity (CCx, CCy) measurements and a tolerance of ±2 on CRI measurements. See the Measurements section (page 33).
- Cree XLamp XP-G2 LED order codes specify only a minimum flux bin and not a maximum. Cree may ship reels in flux bins higher than the minimum specified by the order code without advance notice. Shipments will always adhere to the chromaticity bin restrictions specified by the order code.
- * Flux values @ 25 °C are calculated and for reference only.

FLUX CHARACTERISTICS - HIGH EFFICACY ($T_j = 85\text{ }^\circ\text{C}$) - CONTINUED

Chromaticity		Minimum Luminous Flux (lm) @ 350 mA			Order Codes		
Kit	CCT	Code	Flux (lm) @ 85 °C	Flux (lm) @ 25 °C*	70 CRI Minimum	80 CRI Minimum	90 CRI Minimum
E4	4500 K	S4	164	180	XPGBWT-BE-0000-00LE4		
		S3	156	171	XPGBWT-BE-0000-00KE4	XPGBWT-HE-0000-00KE4	
		S2	148	163	XPGBWT-BE-0000-00JE4	XPGBWT-HE-0000-00JE4	
		R5	139	153		XPGBWT-HE-0000-00HE4	
		R4	130	143			
		R3	122	134			XPGBWT-UE-0000-00FE4
		R2	114	125			XPGBWT-UE-0000-00EE4
		Q5	107	118			XPGBWT-UE-0000-00DE4
F5	4250 K	S4	164	180	XPGBWT-BE-0000-00LF5		
		S3	156	171	XPGBWT-BE-0000-00KF5	XPGBWT-HE-0000-00KF5	
		S2	148	163	XPGBWT-BE-0000-00JF5	XPGBWT-HE-0000-00JF5	
		R5	139	153		XPGBWT-HE-0000-00HF5	
		R4	130	143			
		R3	122	134			XPGBWT-UE-0000-00FF5
		R2	114	125			XPGBWT-UE-0000-00EF5
		Q5	107	118			XPGBWT-UE-0000-00DF5
E5	4000 K	S4	164	180	XPGBWT-BE-0000-00LE5		
		S3	156	171	XPGBWT-BE-0000-00KE5	XPGBWT-HE-0000-00KE5	
		S2	148	163	XPGBWT-BE-0000-00JE5	XPGBWT-HE-0000-00JE5	
		R5	139	153		XPGBWT-HE-0000-00HE5	
		R4	130	143			
		R3	122	134			XPGBWT-UE-0000-00FE5
		R2	114	125			XPGBWT-UE-0000-00EE5
		Q5	107	118			XPGBWT-UE-0000-00DE5

Notes

- Cree maintains a tolerance of $\pm 7\%$ on flux and power measurements, ± 0.005 on chromaticity (CCx, CCy) measurements and a tolerance of ± 2 on CRI measurements. See the Measurements section (page 33).
- Cree XLamp XP-G2 LED order codes specify only a minimum flux bin and not a maximum. Cree may ship reels in flux bins higher than the minimum specified by the order code without advance notice. Shipments will always adhere to the chromaticity bin restrictions specified by the order code.
- * Flux values @ 25 °C are calculated and for reference only.

FLUX CHARACTERISTICS - HIGH EFFICACY ($T_j = 85\text{ }^\circ\text{C}$) - CONTINUED

Chromaticity		Minimum Luminous Flux (lm) @ 350 mA			Order Codes		
Kit	CCT	Code	Flux (lm) @ 85 °C	Flux (lm) @ 25 °C*	70 CRI Minimum	80 CRI Minimum	90 CRI Minimum
F6	3750 K	S4	164	180	XPGBWT-BE-0000-00LF6		
		S3	156	171	XPGBWT-BE-0000-00KF6		
		S2	148	163	XPGBWT-BE-0000-00JF6	XPGBWT-HE-0000-00JF6	
		R5	139	153		XPGBWT-HE-0000-00HF6	
		R4	130	143			
		R3	122	134			XPGBWT-UE-0000-00FF6
		R2	114	125			XPGBWT-UE-0000-00EF6
		Q5	107	118			XPGBWT-UE-0000-00DF6
		Q4	100	110			XPGBWT-UE-0000-00CF6
E6	3500 K	S4	164	180	XPGBWT-BE-0000-00LE6		
		S3	156	171	XPGBWT-BE-0000-00KE6		
		S2	148	163	XPGBWT-BE-0000-00JE6	XPGBWT-HE-0000-00JE6	
		R5	139	153		XPGBWT-HE-0000-00HE6	
		R4	130	143			
		R3	122	134			XPGBWT-UE-0000-00FE6
		R2	114	125			XPGBWT-UE-0000-00EE6
		Q5	107	118			XPGBWT-UE-0000-00DE6
		Q4	100	110			XPGBWT-UE-0000-00CE6
F7	3250 K	S3	156	171	XPGBWT-BE-0000-00KF7		
		S2	148	163	XPGBWT-BE-0000-00JF7		
		R5	139	153	XPGBWT-BE-0000-00HF7	XPGBWT-HE-0000-00HF7	
		R4	130	143		XPGBWT-HE-0000-00GF7	
		R3	122	134			XPGBWT-UE-0000-00FF7
		R2	114	125			XPGBWT-UE-0000-00EF7
		Q5	107	118			XPGBWT-UE-0000-00DF7
		Q4	100	110			XPGBWT-UE-0000-00CF7

Notes

- Cree maintains a tolerance of $\pm 7\%$ on flux and power measurements, ± 0.005 on chromaticity (CCx, CCy) measurements and a tolerance of ± 2 on CRI measurements. See the Measurements section (page 33).
- Cree XLamp XP-G2 LED order codes specify only a minimum flux bin and not a maximum. Cree may ship reels in flux bins higher than the minimum specified by the order code without advance notice. Shipments will always adhere to the chromaticity bin restrictions specified by the order code.
- * Flux values @ 25 °C are calculated and for reference only.

FLUX CHARACTERISTICS - HIGH EFFICACY ($T_j = 85\text{ }^\circ\text{C}$) - CONTINUED

Chromaticity		Minimum Luminous Flux (lm) @ 350 mA			Order Codes		
Kit	CCT	Code	Flux (lm) @ 85 °C	Flux (lm) @ 25 °C*	70 CRI Minimum	80 CRI Minimum	90 CRI Minimum
E7	3000 K	S3	156	171	XPGBWT-BE-0000-00KE7		
		S2	148	163	XPGBWT-BE-0000-00JE7		
		R5	139	153	XPGBWT-BE-0000-00HE7	XPGBWT-HE-0000-00HE7	
		R4	130	143		XPGBWT-HE-0000-00GE7	
		R3	122	134			XPGBWT-UE-0000-00FE7
		R2	114	125			XPGBWT-UE-0000-00EE7
		Q5	107	118			XPGBWT-UE-0000-00DE7
		Q4	100	110			XPGBWT-UE-0000-00CE7
F8	2850 K	S3	156	171	XPGBWT-BE-0000-00KF8		
		S2	148	163	XPGBWT-BE-0000-00JF8		
		R5	139	153	XPGBWT-BE-0000-00HF8	XPGBWT-HE-0000-00HF8	
		R4	130	143		XPGBWT-HE-0000-00GF8	
		R3	122	134			
		R2	114	125			XPGBWT-UE-0000-00EF8
		Q5	107	118			XPGBWT-UE-0000-00DF8
		Q4	100	110			XPGBWT-UE-0000-00CF8
E8	2700 K	S3	156	171	XPGBWT-BE-0000-00KE8		
		S2	148	163	XPGBWT-BE-0000-00JE8		
		R5	139	153	XPGBWT-BE-0000-00HE8	XPGBWT-HE-0000-00HE8	
		R4	130	143		XPGBWT-HE-0000-00GE8	
		R3	122	134			
		R2	114	125			XPGBWT-UE-0000-00EE8
		Q5	107	118			XPGBWT-UE-0000-00DE8
		Q4	100	110			XPGBWT-UE-0000-00CE8

Notes

- Cree maintains a tolerance of $\pm 7\%$ on flux and power measurements, ± 0.005 on chromaticity (CCx, CCy) measurements and a tolerance of ± 2 on CRI measurements. See the Measurements section (page 33).
- Cree XLamp XP-G2 LED order codes specify only a minimum flux bin and not a maximum. Cree may ship reels in flux bins higher than the minimum specified by the order code without advance notice. Shipments will always adhere to the chromaticity bin restrictions specified by the order code.
- * Flux values @ 25 °C are calculated and for reference only.

FLUX CHARACTERISTICS - STANDARD ($T_j = 85\text{ °C}$)

The following table provides order codes for XLamp Standard XP-G2 LEDs. For a complete description of the order code nomenclature, please see the Bin and Order Code Formats section (page 31). For definitions of the chromaticity kits, please see the Cree's Standard Chromaticity Kits section (page 30).

Chromaticity		Minimum Luminous Flux (lm) @ 350 mA			Order Codes
Kit	CCT	Code	Flux (lm) @ 85 °C	Flux (lm) @ 25 °C*	70 CRI Typical
51	6200 K	S4	164	180	XPGBWT-L1-0000-00L51
		S3	156	171	XPGBWT-L1-0000-00K51
		S2	148	163	XPGBWT-L1-0000-00J51
		R5	139	153	XPGBWT-L1-0000-00H51
		R4	130	143	XPGBWT-L1-0000-00G51
		R3	122	134	XPGBWT-L1-0000-00F51
53	6000 K	S4	164	180	XPGBWT-L1-0000-00L53
		S3	156	171	XPGBWT-L1-0000-00K53
		S2	148	163	XPGBWT-L1-0000-00J53
		R5	139	153	XPGBWT-L1-0000-00H53
		R4	130	143	XPGBWT-L1-0000-00G53
		R3	122	134	XPGBWT-L1-0000-00F53
50	6200 K	S4	164	180	XPGBWT-L1-0000-00L50
		S3	156	171	XPGBWT-L1-0000-00K50
		S2	148	163	XPGBWT-L1-0000-00J50
		R5	139	153	XPGBWT-L1-0000-00H50
		R4	130	143	XPGBWT-L1-0000-00G50
		R3	122	134	XPGBWT-L1-0000-00F50
E1	6500 K	S4	164	180	XPGBWT-L1-0000-00LE1
		S3	156	171	XPGBWT-L1-0000-00KE1
		S2	148	163	XPGBWT-L1-0000-00JE1
		R5	139	153	XPGBWT-L1-0000-00HE1
		R4	130	143	XPGBWT-L1-0000-00GE1
		R3	122	134	XPGBWT-L1-0000-00FE1

Notes

- Cree maintains a tolerance of $\pm 7\%$ on flux and power measurements, ± 0.005 on chromaticity (CCx, CCy) measurements and a tolerance of ± 2 on CRI measurements. See the Measurements section (page 33).
- Cree XLamp XP-G2 LED order codes specify only a minimum flux bin and not a maximum. Cree may ship reels in flux bins higher than the minimum specified by the order code without advance notice. Shipments will always adhere to the chromaticity bin restrictions specified by the order code.
- * Flux values @ 25 °C are calculated and for reference only.

FLUX CHARACTERISTICS - STANDARD (T_j = 85 °C) - CONTINUED

Chromaticity		Minimum Luminous Flux (lm) @ 350 mA			Order Codes
Kit	CCT	Code	Flux (lm) @ 85 °C	Flux (lm) @ 25 °C*	70 CRI Typical
E2	5700 K	S4	164	180	XPGBWT-L1-0000-00LE2
		S3	156	171	XPGBWT-L1-0000-00KE2
		S2	148	163	XPGBWT-L1-0000-00JE2
		R5	139	153	XPGBWT-L1-0000-00HE2
		R4	130	143	XPGBWT-L1-0000-00GE2
		R3	122	134	XPGBWT-L1-0000-00FE2

Chromaticity		Minimum Luminous Flux (lm) @ 350 mA			Order Codes	
Kit	CCT	Code	Flux (lm) @ 85 °C	Flux (lm) @ 25 °C*	70 CRI Typical	80 CRI Minimum
E3	5000 K	S4	164	180	XPGBWT-01-0000-00LE3	
		S3	156	171	XPGBWT-01-0000-00KE3	
		S2	148	163	XPGBWT-01-0000-00JE3	
		R5	139	153	XPGBWT-01-0000-00HE3	
		R4	130	143	XPGBWT-01-0000-00GE3	
		R3	122	134	XPGBWT-01-0000-00FE3	
		R2	114	125	XPGBWT-01-0000-00EE3	
F4	4750 K	S4	164	180	XPGBWT-01-0000-00LF4	
		S3	156	171	XPGBWT-01-0000-00KF4	
		S2	148	163	XPGBWT-01-0000-00JF4	
		R5	139	153	XPGBWT-01-0000-00HF4	
		R4	130	143	XPGBWT-01-0000-00GF4	
		R3	122	134	XPGBWT-01-0000-00FF4	
		R2	114	125	XPGBWT-01-0000-00EF4	

Notes

- Cree maintains a tolerance of $\pm 7\%$ on flux and power measurements, ± 0.005 on chromaticity (CCx, CCy) measurements and a tolerance of ± 2 on CRI measurements. See the Measurements section (page 33).
- Cree XLamp XP-G2 LED order codes specify only a minimum flux bin and not a maximum. Cree may ship reels in flux bins higher than the minimum specified by the order code without advance notice. Shipments will always adhere to the chromaticity bin restrictions specified by the order code.
- * Flux values @ 25 °C are calculated and for reference only.

FLUX CHARACTERISTICS - STANDARD (T_j = 85 °C) - CONTINUED

Chromaticity		Minimum Luminous Flux (lm) @ 350 mA			Order Codes	
Kit	CCT	Code	Flux (lm) @ 85 °C	Flux (lm) @ 25 °C*	70 CRI Typical	80 CRI Minimum
E4	4500 K	S4	164	180	XPGBWT-01-0000-00LE4	
		S3	156	171	XPGBWT-01-0000-00KE4	
		S2	148	163	XPGBWT-01-0000-00JE4	
		R5	139	153	XPGBWT-01-0000-00HE4	
		R4	130	143	XPGBWT-01-0000-00GE4	
		R3	122	134	XPGBWT-01-0000-00FE4	
		R2	114	125	XPGBWT-01-0000-00EE4	
F5	4250 K	S4	164	180	XPGBWT-01-0000-00LF5	
		S3	156	171	XPGBWT-01-0000-00KF5	
		S2	148	163	XPGBWT-01-0000-00JF5	
		R5	139	153	XPGBWT-01-0000-00HF5	
		R4	130	143	XPGBWT-01-0000-00GF5	
		R3	122	134	XPGBWT-01-0000-00FF5	
		R2	114	125	XPGBWT-01-0000-00EF5	
E5	4000 K	S4	164	180	XPGBWT-01-0000-00LE5	
		S3	156	171	XPGBWT-01-0000-00KE5	
		S2	148	163	XPGBWT-01-0000-00JE5	
		R5	139	153	XPGBWT-01-0000-00HE5	XPGBWT-H1-0000-00HE5
		R4	130	143	XPGBWT-01-0000-00GE5	XPGBWT-H1-0000-00GE5
		R3	122	134	XPGBWT-01-0000-00FE5	XPGBWT-H1-0000-00FE5
		R2	114	125	XPGBWT-01-0000-00EE5	XPGBWT-H1-0000-00EE5
		Q5	107	118		XPGBWT-H1-0000-00DE5
Z5	4000 K	R5	139	153		XPGBWT-H1-0000-00HZ5
		R4	130	143		XPGBWT-H1-0000-00GZ5
		R3	122	134		XPGBWT-H1-0000-00FZ5
		R2	114	125		XPGBWT-H1-0000-00EZ5
		Q5	107	118		XPGBWT-H1-0000-00DZ5

Notes

- Cree maintains a tolerance of ±7% on flux and power measurements, ±0.005 on chromaticity (CCx, CCy) measurements and a tolerance of ±2 on CRI measurements. See the Measurements section (page 33).
- Cree XLamp XP-G2 LED order codes specify only a minimum flux bin and not a maximum. Cree may ship reels in flux bins higher than the minimum specified by the order code without advance notice. Shipments will always adhere to the chromaticity bin restrictions specified by the order code.
- * Flux values @ 25 °C are calculated and for reference only.

FLUX CHARACTERISTICS - STANDARD (T_j = 85 °C) - CONTINUED

Chromaticity		Minimum Luminous Flux (lm) @ 350 mA			Order Codes			
Kit	CCT	Code	Flux (lm) @ 85 °C	Flux (lm) @ 25 °C*	70 CRI Typical	80 CRI Typical	80 CRI Minimum	90 CRI Minimum
F6	3750 K	S2	148	163	XPGBWT-01-0000-00JF6			
		R5	139	153	XPGBWT-01-0000-00HF6	XPGBWT-L1-0000-00HF6	XPGBWT-H1-0000-00HF6	
		R4	130	143	XPGBWT-01-0000-00GF6	XPGBWT-L1-0000-00GF6	XPGBWT-H1-0000-00GF6	
		R3	122	134	XPGBWT-01-0000-00FF6	XPGBWT-L1-0000-00FF6	XPGBWT-H1-0000-00FF6	
		R2	114	125	XPGBWT-01-0000-00EF6	XPGBWT-L1-0000-00EF6	XPGBWT-H1-0000-00EF6	
		Q5	107	118	XPGBWT-01-0000-00DF6	XPGBWT-L1-0000-00DF6	XPGBWT-H1-0000-00DF6	
E6	3500 K	S2	148	163	XPGBWT-01-0000-00JE6			
		R5	139	153	XPGBWT-01-0000-00HE6	XPGBWT-L1-0000-00HE6	XPGBWT-H1-0000-00HE6	
		R4	130	143	XPGBWT-01-0000-00GE6	XPGBWT-L1-0000-00GE6	XPGBWT-H1-0000-00GE6	
		R3	122	134	XPGBWT-01-0000-00FE6	XPGBWT-L1-0000-00FE6	XPGBWT-H1-0000-00FE6	
		R2	114	125	XPGBWT-01-0000-00EE6	XPGBWT-L1-0000-00EE6	XPGBWT-H1-0000-00EE6	
		Q5	107	118	XPGBWT-01-0000-00DE6	XPGBWT-L1-0000-00DE6	XPGBWT-H1-0000-00DE6	
Z6	3500 K	R4	130	143		XPGBWT-L1-0000-00GZ6	XPGBWT-H1-0000-00GZ6	
		R3	122	134		XPGBWT-L1-0000-00FZ6	XPGBWT-H1-0000-00FZ6	
		R2	114	125		XPGBWT-L1-0000-00EZ6	XPGBWT-H1-0000-00EZ6	
		Q5	107	118		XPGBWT-L1-0000-00DZ6	XPGBWT-H1-0000-00DZ6	
F7	3250 K	S2	148	163	XPGBWT-01-0000-00JF7			
		R5	139	153	XPGBWT-01-0000-00HF7	XPGBWT-L1-0000-00HF7	XPGBWT-H1-0000-00HF7	
		R4	130	143	XPGBWT-01-0000-00GF7	XPGBWT-L1-0000-00GF7	XPGBWT-H1-0000-00GF7	
		R3	122	134	XPGBWT-01-0000-00FF7	XPGBWT-L1-0000-00FF7	XPGBWT-H1-0000-00FF7	
		R2	114	125	XPGBWT-01-0000-00EF7	XPGBWT-L1-0000-00EF7	XPGBWT-H1-0000-00EF7	
		Q5	107	118		XPGBWT-L1-0000-00DF7	XPGBWT-H1-0000-00DF7	

Notes

- Cree maintains a tolerance of ±7% on flux and power measurements, ±0.005 on chromaticity (CCx, CCy) measurements and a tolerance of ±2 on CRI measurements. See the Measurements section (page 33).
- Cree XLamp XP-G2 LED order codes specify only a minimum flux bin and not a maximum. Cree may ship reels in flux bins higher than the minimum specified by the order code without advance notice. Shipments will always adhere to the chromaticity bin restrictions specified by the order code.
- * Flux values @ 25 °C are calculated and for reference only.

FLUX CHARACTERISTICS - STANDARD (T_j = 85 °C) - CONTINUED

Chromaticity		Minimum Luminous Flux (lm) @ 350 mA			Order Codes				
Kit	CCT	Code	Flux (lm) @ 85 °C	Flux (lm) @ 25 °C*	70 CRI Typical	80 CRI Typical	80 CRI Minimum	90 CRI Minimum	
E7	3000 K	S2	148	163	XPGBWT-01-0000-00JE7				
		R5	139	153	XPGBWT-01-0000-00HE7	XPGBWT-L1-0000-00HE7	XPGBWT-H1-0000-00HE7		
		R4	130	143	XPGBWT-01-0000-00GE7	XPGBWT-L1-0000-00GE7	XPGBWT-H1-0000-00GE7		
		R3	122	134	XPGBWT-01-0000-00FE7	XPGBWT-L1-0000-00FE7	XPGBWT-H1-0000-00FE7		
		R2	114	125	XPGBWT-01-0000-00EE7	XPGBWT-L1-0000-00EE7	XPGBWT-H1-0000-00EE7	XPGBWT-U1-0000-00EE7	
		Q5	107	118		XPGBWT-L1-0000-00DE7	XPGBWT-H1-0000-00DE7	XPGBWT-U1-0000-00DE7	
		Q4	100	110		XPGBWT-L1-0000-00CE7	XPGBWT-H1-0000-00CE7	XPGBWT-U1-0000-00CE7	
		Q3	93.9	103				XPGBWT-U1-0000-00BE7	
		Q2	87.4	96.1				XPGBWT-U1-0000-00AE7	
		P4	80.6	88.6				XPGBWT-U1-0000-009E7	
		P3	73.9	81.2				XPGBWT-U1-0000-008E7	
Z7	3000 K	R4	130	143		XPGBWT-L1-0000-00GZ7	XPGBWT-H1-0000-00GZ7		
		R3	122	134		XPGBWT-L1-0000-00FZ7	XPGBWT-H1-0000-00FZ7		
		R2	114	125		XPGBWT-L1-0000-00EZ7	XPGBWT-H1-0000-00EZ7		
		Q5	107	118		XPGBWT-L1-0000-00DZ7	XPGBWT-H1-0000-00DZ7	XPGBWT-U1-0000-00DZ7	
		Q4	100	110		XPGBWT-L1-0000-00CZ7	XPGBWT-H1-0000-00CZ7	XPGBWT-U1-0000-00CZ7	
		Q3	93.9	103				XPGBWT-U1-0000-00BZ7	
		Q2	87.4	96.1				XPGBWT-U1-0000-00AZ7	
		P4	80.6	88.6				XPGBWT-U1-0000-009Z7	
		P3	73.9	81.2				XPGBWT-U1-0000-008Z7	

Notes

- Cree maintains a tolerance of ±7% on flux and power measurements, ±0.005 on chromaticity (CCx, CCy) measurements and a tolerance of ±2 on CRI measurements. See the Measurements section (page 33).
- Cree XLamp XP-G2 LED order codes specify only a minimum flux bin and not a maximum. Cree may ship reels in flux bins higher than the minimum specified by the order code without advance notice. Shipments will always adhere to the chromaticity bin restrictions specified by the order code.
- * Flux values @ 25 °C are calculated and for reference only.

FLUX CHARACTERISTICS - STANDARD (T_j = 85 °C) - CONTINUED

Chromaticity		Minimum Luminous Flux (lm) @ 350 mA			Order Codes			
Kit	CCT	Code	Flux (lm) @ 85 °C	Flux (lm) @ 25 °C*	70 CRI Typical	80 CRI Typical	80 CRI Minimum	90 CRI Minimum
F8	2850 K	R4	130	143		XPGBWT-L1-0000-00GF8	XPGBWT-H1-0000-00GF8	
		R3	122	134		XPGBWT-L1-0000-00FF8	XPGBWT-H1-0000-00FF8	
		R2	114	125		XPGBWT-L1-0000-00EF8	XPGBWT-H1-0000-00EF8	
		Q5	107	118		XPGBWT-L1-0000-00DF8	XPGBWT-H1-0000-00DF8	XPGBWT-U1-0000-00DF8
		Q4	100	110		XPGBWT-L1-0000-00CF8	XPGBWT-H1-0000-00CF8	XPGBWT-U1-0000-00CF8
		Q3	93.9	103		XPGBWT-L1-0000-00BF8	XPGBWT-H1-0000-00BF8	XPGBWT-U1-0000-00BF8
		Q2	87.4	96.1				XPGBWT-U1-0000-00AF8
		P4	80.6	88.6				XPGBWT-U1-0000-009F8
		P3	73.9	81.2				XPGBWT-U1-0000-008F8
		P2	67.2	73.9				XPGBWT-U1-0000-007F8
E8	2700 K	R4	130	143		XPGBWT-L1-0000-00GE8	XPGBWT-H1-0000-00GE8	
		R3	122	134		XPGBWT-L1-0000-00FE8	XPGBWT-H1-0000-00FE8	
		R2	114	125		XPGBWT-L1-0000-00EE8	XPGBWT-H1-0000-00EE8	
		Q5	107	118		XPGBWT-L1-0000-00DE8	XPGBWT-H1-0000-00DE8	
		Q4	100	110		XPGBWT-L1-0000-00CE8	XPGBWT-H1-0000-00CE8	XPGBWT-U1-0000-00CE8
		Q3	93.9	103		XPGBWT-L1-0000-00BE8	XPGBWT-H1-0000-00BE8	XPGBWT-U1-0000-00BE8
		Q2	87.4	96.1				XPGBWT-U1-0000-00AE8
		P4	80.6	88.6				XPGBWT-U1-0000-009E8
		P3	73.9	81.2				XPGBWT-U1-0000-008E8
		P2	67.2	73.9				XPGBWT-U1-0000-007E8
Z8	2700 K	R3	122	134		XPGBWT-L1-0000-00FZ8	XPGBWT-H1-0000-00FZ8	
		R2	114	125		XPGBWT-L1-0000-00EZ8	XPGBWT-H1-0000-00EZ8	
		Q5	107	118		XPGBWT-L1-0000-00DZ8	XPGBWT-H1-0000-00DZ8	
		Q4	100	110		XPGBWT-L1-0000-00CZ8	XPGBWT-H1-0000-00CZ8	
		Q3	93.9	103		XPGBWT-L1-0000-00BZ8	XPGBWT-H1-0000-00BZ8	XPGBWT-U1-0000-00BZ8
		Q2	87.4	96.1				XPGBWT-U1-0000-00AZ8
		P4	80.6	88.6				XPGBWT-U1-0000-009Z8
		P3	73.9	81.2				XPGBWT-U1-0000-008Z8
		P2	67.2	73.9				XPGBWT-U1-0000-007Z8

Notes

- Cree maintains a tolerance of $\pm 7\%$ on flux and power measurements, ± 0.005 on chromaticity (CC_x, CC_y) measurements and a tolerance of ± 2 on CRI measurements. See the Measurements section (page 33).
- Cree XLamp XP-G2 LED order codes specify only a minimum flux bin and not a maximum. Cree may ship reels in flux bins higher than the minimum specified by the order code without advance notice. Shipments will always adhere to the chromaticity bin restrictions specified by the order code.
- * Flux values @ 25 °C are calculated and for reference only.

RELATIVE SPECTRAL POWER DISTRIBUTION

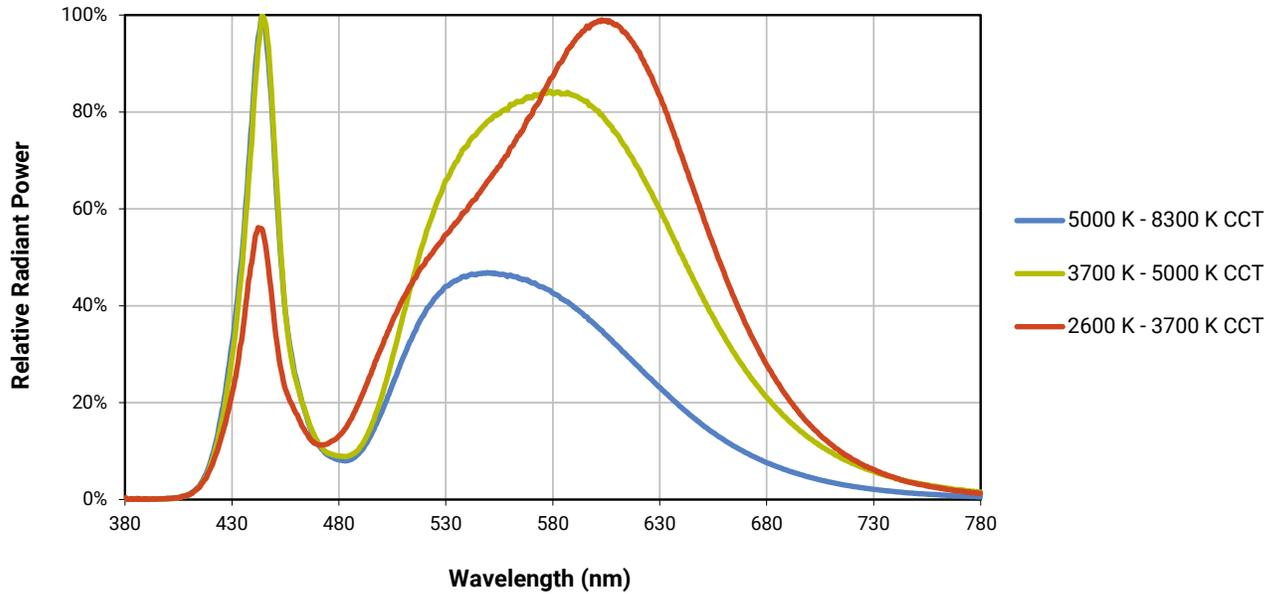

RELATIVE FLUX VS. JUNCTION TEMPERATURE ($I_F = 350$ mA)

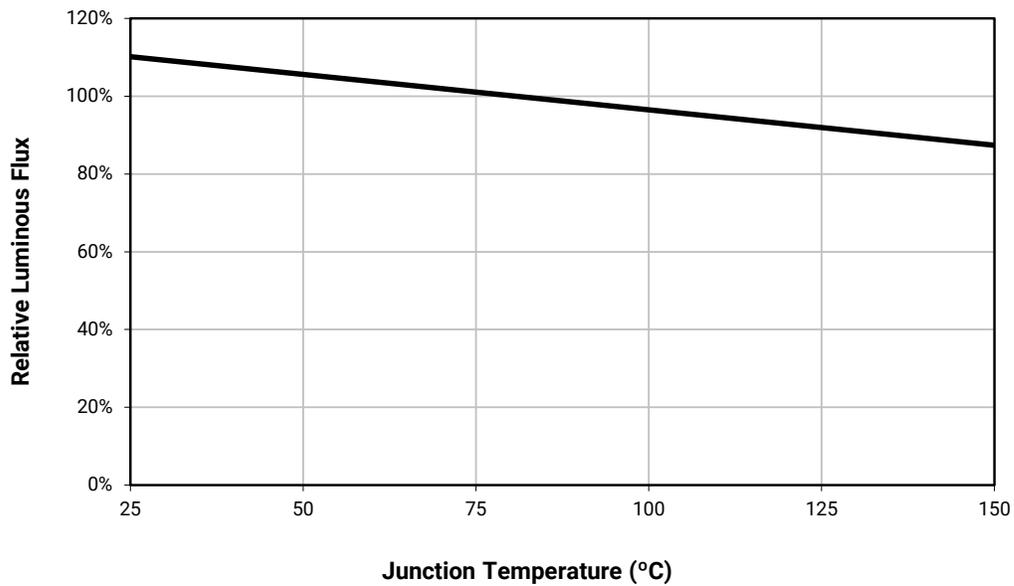

ELECTRICAL CHARACTERISTICS - HIGH EFFICACY ($T_j = 85\text{ }^\circ\text{C}$)

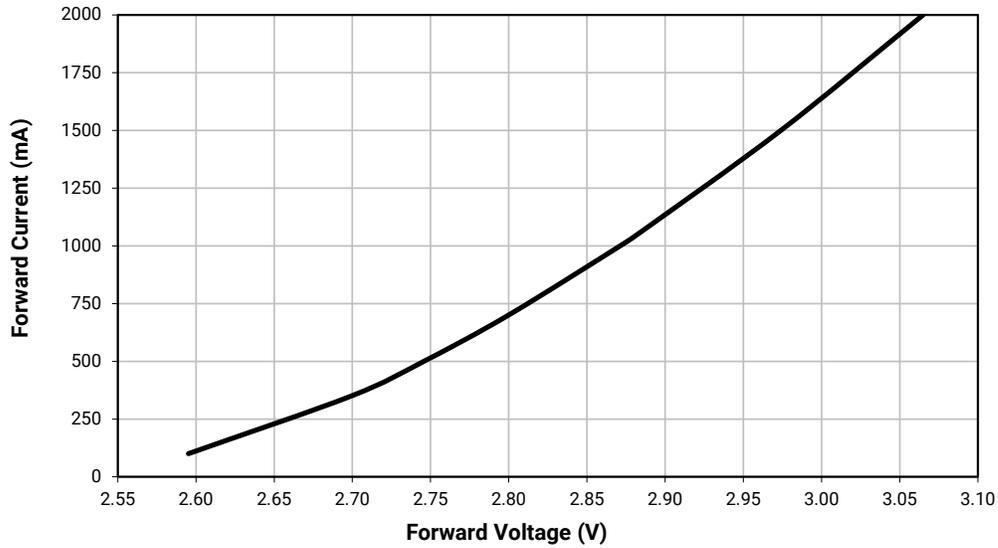

ELECTRICAL CHARACTERISTICS - STANDARD ($T_j = 85\text{ }^\circ\text{C}$)

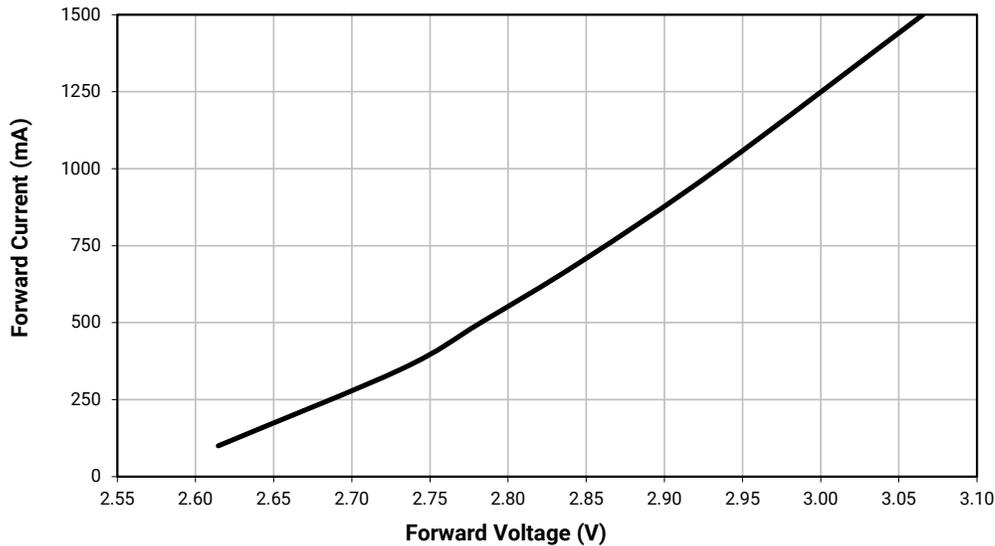

RELATIVE FLUX VS. CURRENT - HIGH EFFICACY ($T_j = 85\text{ }^\circ\text{C}$)

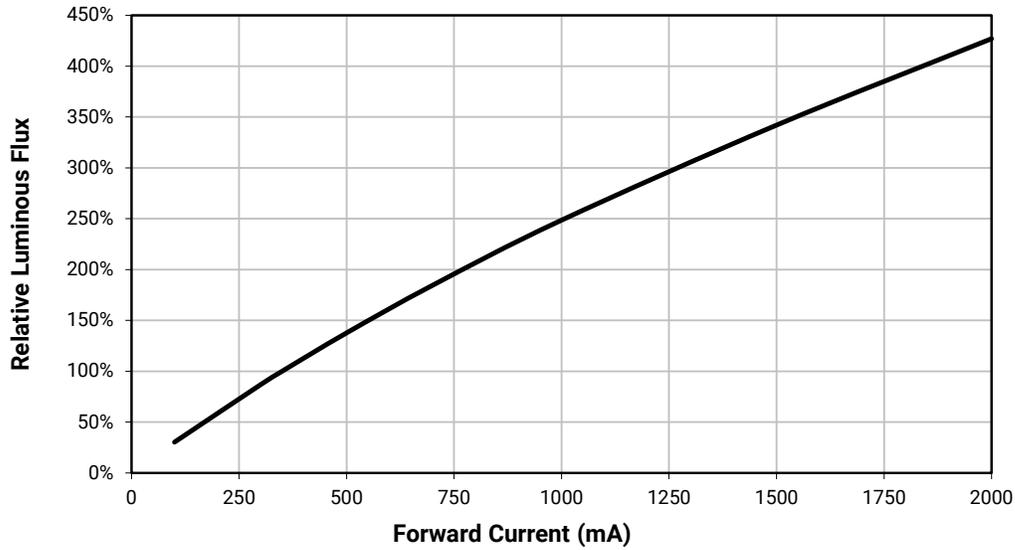

RELATIVE FLUX VS. CURRENT - STANDARD ($T_j = 85\text{ }^\circ\text{C}$)

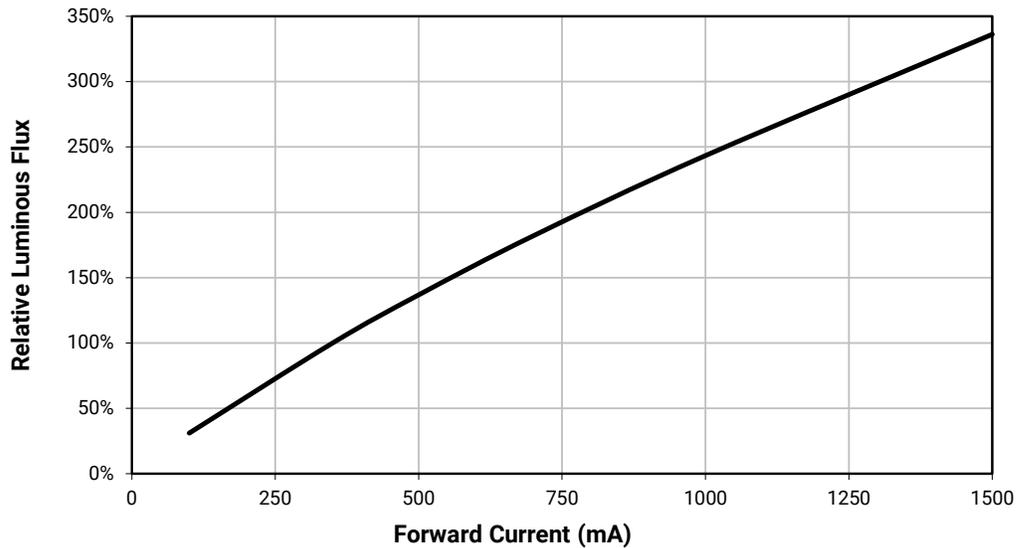

RELATIVE CHROMATICITY VS CURRENT AND TEMPERATURE - HIGH EFFICACY (WARM WHITE)

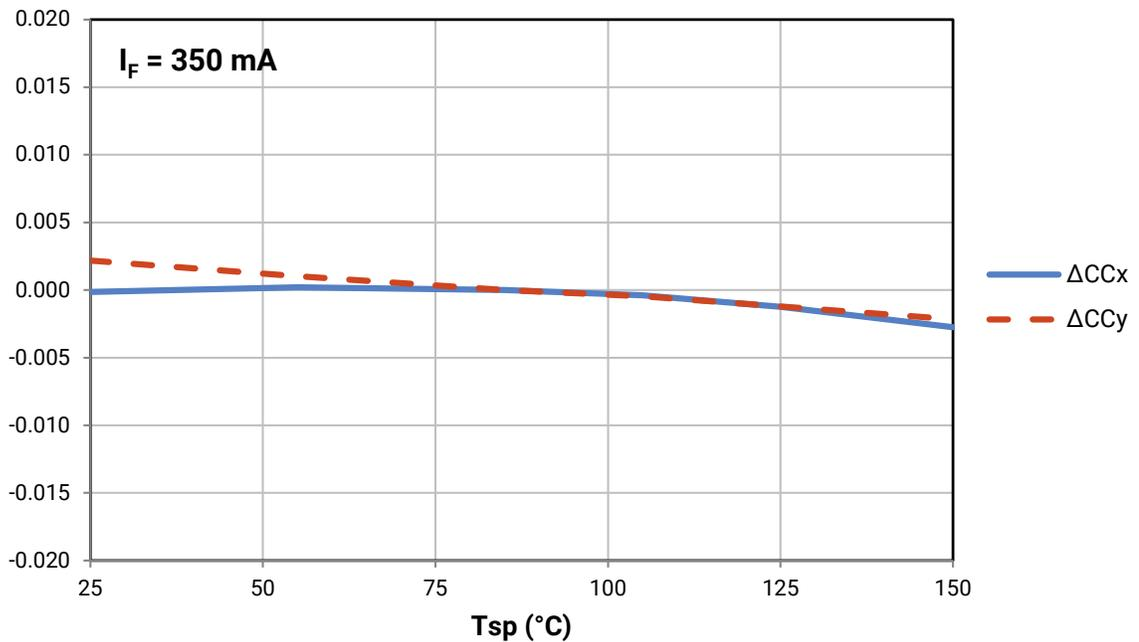
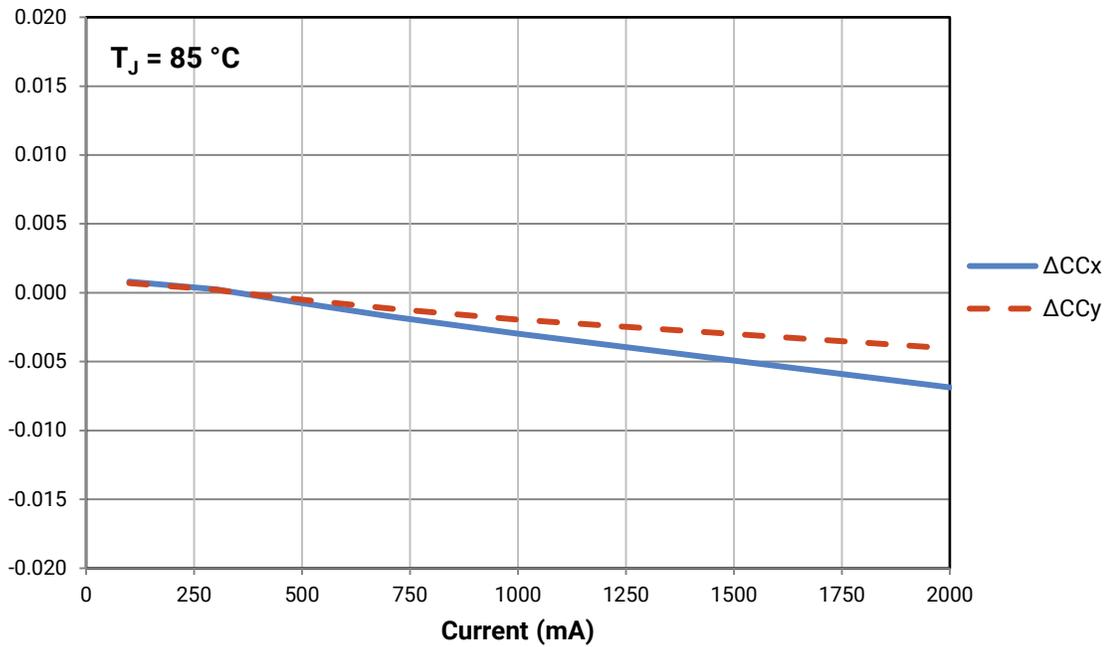

RELATIVE CHROMATICITY VS CURRENT AND TEMPERATURE - STANDARD (WARM WHITE*)

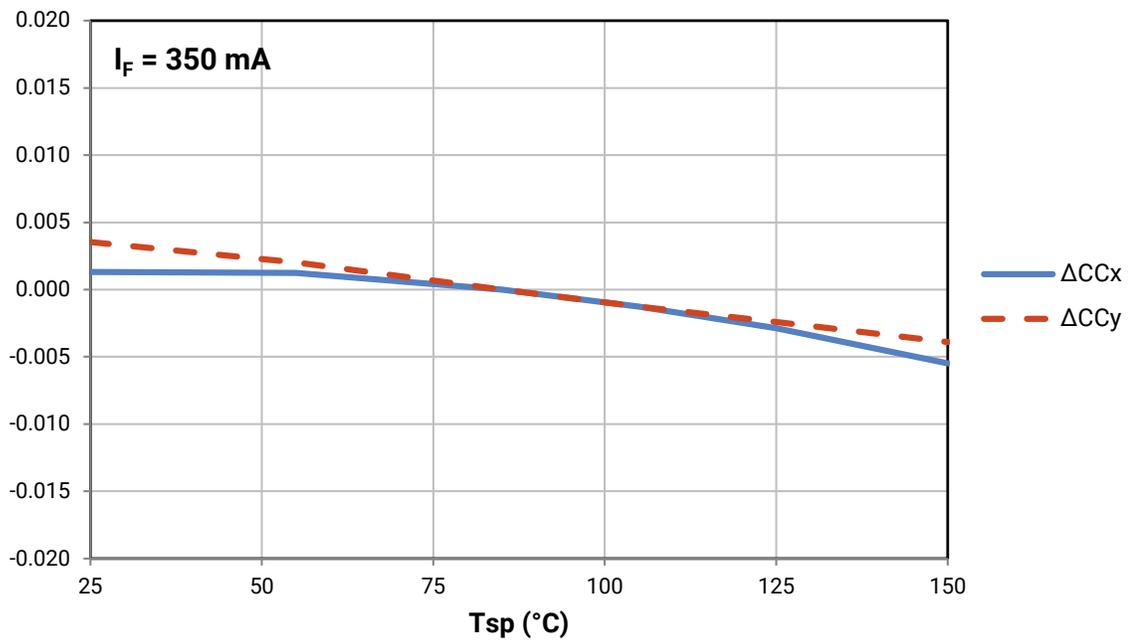
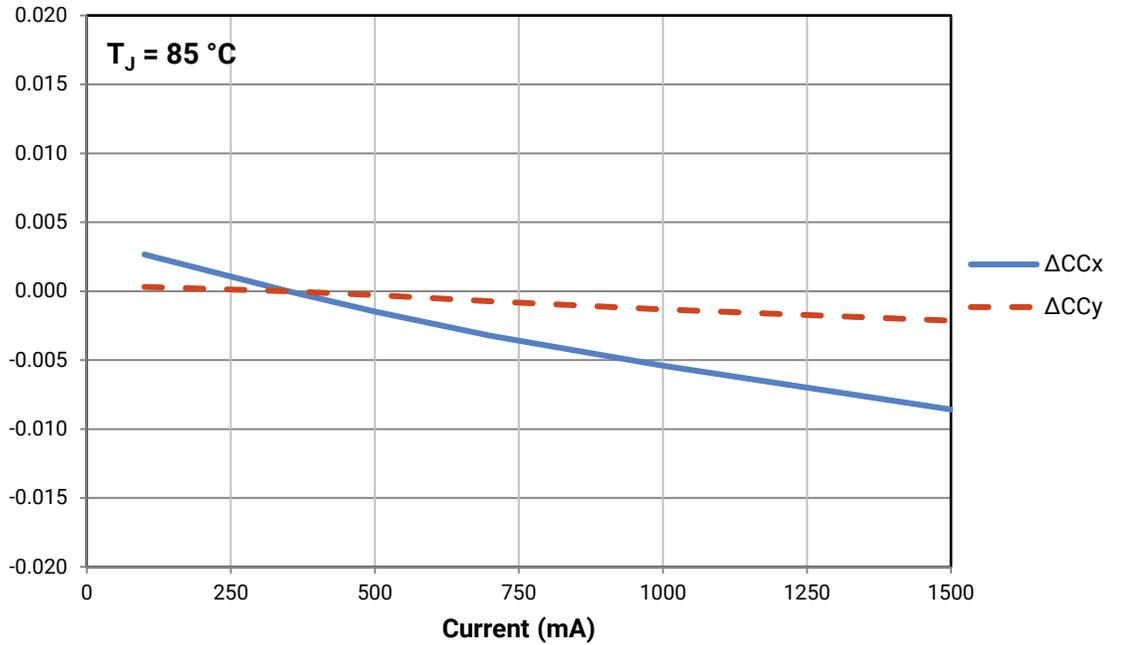

* Warm White XLamp XP-G2 LEDs have a typical CRI of 80.

TYPICAL SPATIAL DISTRIBUTION - HIGH EFFICACY

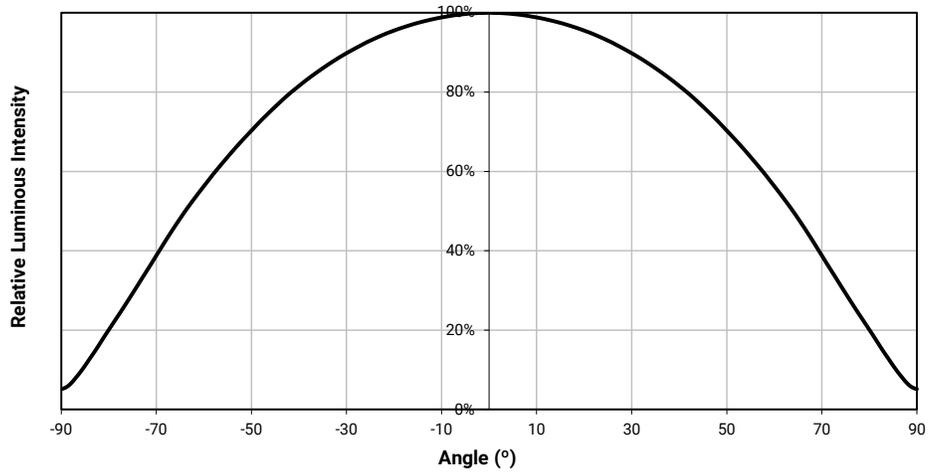

TYPICAL SPATIAL DISTRIBUTION - STANDARD

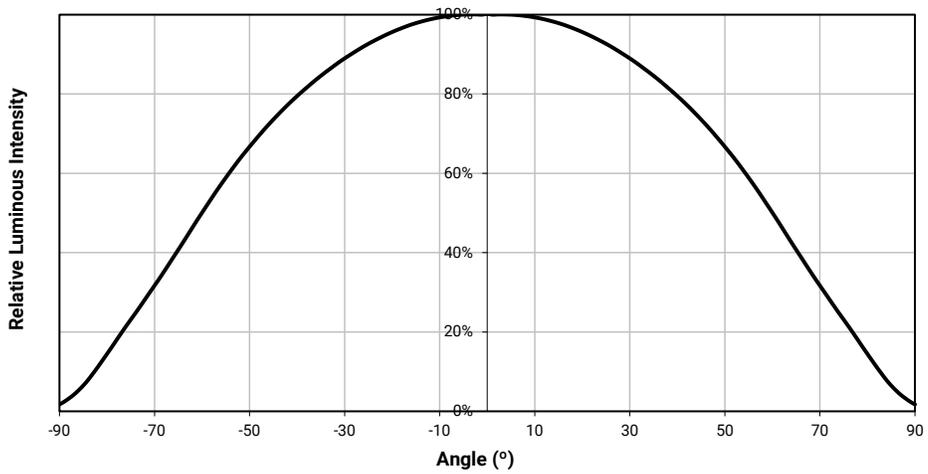

THERMAL DESIGN - HIGH EFFICACY

The maximum forward current is determined by the thermal resistance between the LED junction and ambient. It is crucial for the end product to be designed in a manner that minimizes the thermal resistance from the solder point to ambient in order to optimize lamp life and optical characteristics.

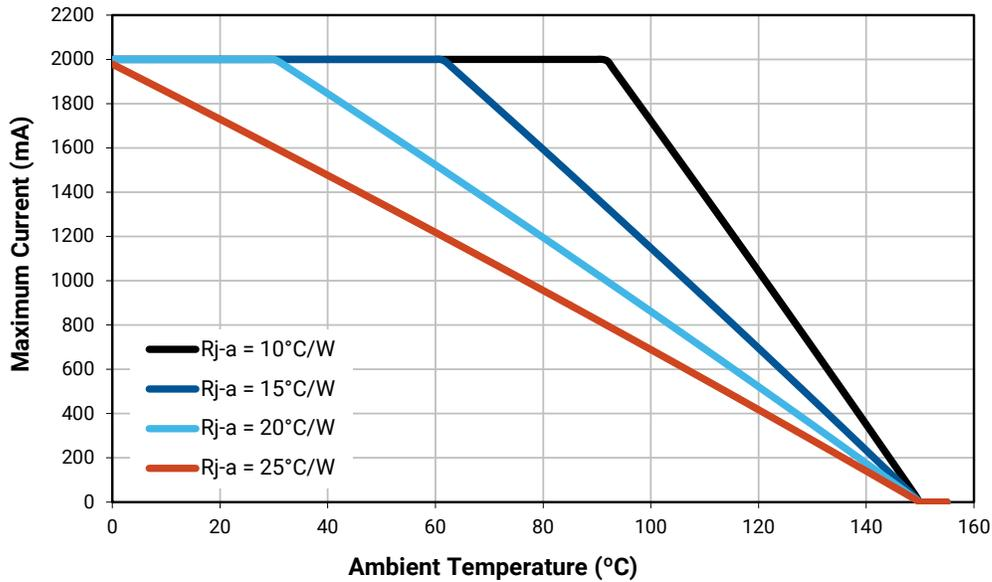

THERMAL DESIGN - STANDARD

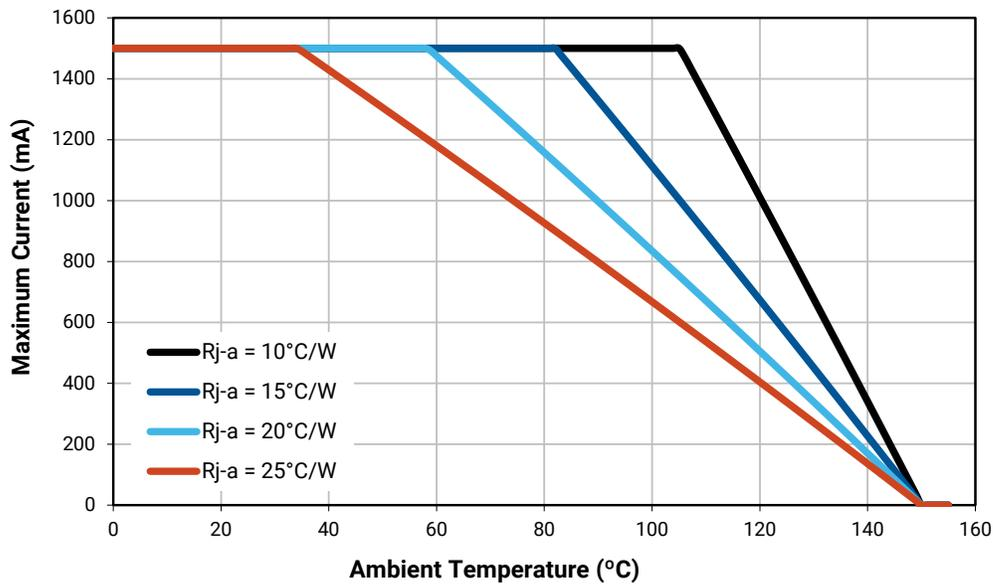

PERFORMANCE GROUPS – LUMINOUS FLUX

XLamp XP-G2 LEDs are tested for luminous flux and placed into one of the following luminous-flux groups:

Group Code	Minimum Luminous Flux (lm) @ 350 mA	Maximum Luminous Flux (lm) @ 350 mA
P2	67.2	73.9
P3	73.9	80.6
P4	80.6	87.4
Q2	87.4	93.9
Q3	93.9	100
Q4	100	107
Q5	107	114
R2	114	122
R3	122	130
R4	130	139
R5	139	148
S2	148	156
S3	156	164
S4	164	172
S5	172	180

PERFORMANCE GROUPS – CHROMATICITY

Region	x	y	Region	x	y	Region	x	y	Region	x	y
0A	0.2950	0.2970	0B	0.2920	0.3060	0C	0.2984	0.3133	0D	0.2984	0.3133
	0.2920	0.3060		0.2895	0.3135		0.2962	0.3220		0.3048	0.3207
	0.2984	0.3133		0.2962	0.3220		0.3028	0.3304		0.3068	0.3113
	0.3009	0.3042		0.2984	0.3133		0.3048	0.3207		0.3009	0.3042
0R	0.2980	0.2880	0S	0.2895	0.3135	0T	0.2962	0.3220	0U	0.3037	0.2937
	0.2950	0.2970		0.2870	0.3210		0.2937	0.3312		0.3009	0.3042
	0.3009	0.3042		0.2937	0.3312		0.3005	0.3415		0.3068	0.3113
	0.3037	0.2937		0.2962	0.3220		0.3028	0.3304		0.3093	0.2993
1A	0.3048	0.3207	1B	0.3028	0.3304	1C	0.3115	0.3391	1D	0.3130	0.3290
	0.3130	0.3290		0.3115	0.3391		0.3205	0.3481		0.3213	0.3373
	0.3144	0.3186		0.3130	0.3290		0.3213	0.3373		0.3221	0.3261
	0.3068	0.3113		0.3048	0.3207		0.3130	0.3290		0.3144	0.3186
1R	0.3068	0.3113	1S	0.3005	0.3415	1T	0.3099	0.3509	1U	0.3144	0.3186
	0.3144	0.3186		0.3099	0.3509		0.3196	0.3602		0.3221	0.3261
	0.3161	0.3059		0.3115	0.3391		0.3205	0.3481		0.3231	0.3120
	0.3093	0.2993		0.3028	0.3304		0.3115	0.3391		0.3161	0.3059
2A	0.3215	0.3350	2B	0.3207	0.3462	2C	0.3290	0.3538	2D	0.3290	0.3417
	0.3290	0.3417		0.3290	0.3538		0.3376	0.3616		0.3371	0.3490
	0.3290	0.3300		0.3290	0.3417		0.3371	0.3490		0.3366	0.3369
	0.3222	0.3243		0.3215	0.3350		0.3290	0.3417		0.3290	0.3300
2R	0.3222	0.3243	2S	0.3196	0.3602	2T	0.3290	0.3690	2U	0.3290	0.3300
	0.3290	0.3300		0.3290	0.3690		0.3381	0.3762		0.3366	0.3369
	0.3290	0.3180		0.3290	0.3538		0.3376	0.3616		0.3361	0.3245
	0.3231	0.3120		0.3207	0.3462		0.3290	0.3538		0.3290	0.3180
3A	0.3371	0.3490	3B	0.3376	0.3616	3C	0.3463	0.3687	3D	0.3451	0.3554
	0.3451	0.3554		0.3463	0.3687		0.3551	0.3760		0.3533	0.3620
	0.3440	0.3427		0.3451	0.3554		0.3533	0.3620		0.3515	0.3487
	0.3366	0.3369		0.3371	0.3490		0.3451	0.3554		0.3440	0.3427
3R	0.3366	0.3369	3S	0.3381	0.3762						
	0.3440	0.3428		0.3480	0.3840						
	0.3429	0.3307		0.3463	0.3687						
	0.3361	0.3245		0.3376	0.3616						
4A	0.3530	0.3597	4B	0.3548	0.3736	4C	0.3641	0.3804	4D	0.3615	0.3659
	0.3615	0.3659		0.3641	0.3804		0.3736	0.3874		0.3702	0.3722
	0.3590	0.3521		0.3615	0.3659		0.3702	0.3722		0.3670	0.3578
	0.3512	0.3465		0.3530	0.3597		0.3615	0.3659		0.3590	0.3521

PERFORMANCE GROUPS – CHROMATICITY (CONTINUED)

Region	x	y	Region	x	y	Region	x	y	Region	x	y
5A1	0.3670	0.3578	5A2	0.3686	0.3649	5A3	0.3744	0.3685	5A4	0.3726	0.3612
	0.3686	0.3649		0.3702	0.3722		0.3763	0.3760		0.3744	0.3685
	0.3744	0.3685		0.3763	0.3760		0.3825	0.3798		0.3804	0.3721
	0.3726	0.3612		0.3744	0.3685		0.3804	0.3721		0.3783	0.3646
5B1	0.3702	0.3722	5B2	0.3719	0.3797	5B3	0.3782	0.3837	5B4	0.3763	0.3760
	0.3719	0.3797		0.3736	0.3874		0.3802	0.3916		0.3782	0.3837
	0.3782	0.3837		0.3802	0.3916		0.3869	0.3958		0.3847	0.3877
	0.3763	0.3760		0.3782	0.3837		0.3847	0.3877		0.3825	0.3798
5C1	0.3825	0.3798	5C2	0.3847	0.3877	5C3	0.3912	0.3917	5C4	0.3887	0.3836
	0.3847	0.3877		0.3869	0.3958		0.3937	0.4001		0.3912	0.3917
	0.3912	0.3917		0.3937	0.4001		0.4006	0.4044		0.3978	0.3958
	0.3887	0.3836		0.3912	0.3917		0.3978	0.3958		0.3950	0.3875
5D1	0.3783	0.3646	5D2	0.3804	0.3721	5D3	0.3863	0.3758	5D4	0.3840	0.3681
	0.3804	0.3721		0.3825	0.3798		0.3887	0.3836		0.3863	0.3758
	0.3863	0.3758		0.3887	0.3836		0.3950	0.3875		0.3924	0.3794
	0.3840	0.3681		0.3863	0.3758		0.3924	0.3794		0.3898	0.3716
6A1	0.3889	0.3690	6A2	0.3915	0.3768	6A3	0.3981	0.3800	6A4	0.3953	0.3720
	0.3915	0.3768		0.3941	0.3848		0.4010	0.3882		0.3981	0.3800
	0.3981	0.3800		0.4010	0.3882		0.4080	0.3916		0.4048	0.3832
	0.3953	0.3720		0.3981	0.3800		0.4048	0.3832		0.4017	0.3751
6B1	0.3941	0.3848	6B2	0.3968	0.3930	6B3	0.4040	0.3966	6B4	0.4010	0.3882
	0.3968	0.3930		0.3996	0.4015		0.4071	0.4052		0.4040	0.3966
	0.4040	0.3966		0.4071	0.4052		0.4146	0.4089		0.4113	0.4001
	0.4010	0.3882		0.4040	0.3966		0.4113	0.4001		0.4080	0.3916
6C1	0.4080	0.3916	6C2	0.4113	0.4001	6C3	0.4186	0.4037	6C4	0.4150	0.3950
	0.4113	0.4001		0.4146	0.4089		0.4222	0.4127		0.4186	0.4037
	0.4186	0.4037		0.4222	0.4127		0.4299	0.4165		0.4259	0.4073
	0.4150	0.3950		0.4186	0.4037		0.4259	0.4073		0.4221	0.3984
6D1	0.4017	0.3751	6D2	0.4048	0.3832	6D3	0.4116	0.3865	6D4	0.4082	0.3782
	0.4048	0.3832		0.4080	0.3916		0.4150	0.3950		0.4116	0.3865
	0.4116	0.3865		0.4150	0.3950		0.4221	0.3984		0.4183	0.3898
	0.4082	0.3782		0.4116	0.3865		0.4183	0.3898		0.4147	0.3814
7A1	0.4147	0.3814	7A2	0.4183	0.3898	7A3	0.4242	0.3919	7A4	0.4203	0.3833
	0.4183	0.3898		0.4221	0.3984		0.4281	0.4006		0.4242	0.3919
	0.4242	0.3919		0.4281	0.4006		0.4342	0.4028		0.4300	0.3939
	0.4203	0.3833		0.4242	0.3919		0.4300	0.3939		0.4259	0.3853

PERFORMANCE GROUPS – CHROMATICITY (CONTINUED)

Region	x	y	Region	x	y	Region	x	y	Region	x	y
7B1	0.4221	0.3984	7B2	0.4259	0.4073	7B3	0.4322	0.4096	7B4	0.4281	0.4006
	0.4259	0.4073		0.4299	0.4165		0.4364	0.4188		0.4322	0.4096
	0.4322	0.4096		0.4364	0.4188		0.4430	0.4212		0.4385	0.4119
	0.4281	0.4006		0.4322	0.4096		0.4385	0.4119		0.4342	0.4028
7C1	0.4342	0.4028	7C2	0.4385	0.4119	7C3	0.4449	0.4141	7C4	0.4403	0.4049
	0.4385	0.4119		0.4430	0.4212		0.4496	0.4236		0.4449	0.4141
	0.4449	0.4141		0.4496	0.4236		0.4562	0.4260		0.4513	0.4164
	0.4403	0.4049		0.4449	0.4141		0.4513	0.4164		0.4465	0.4071
7D1	0.4259	0.3853	7D2	0.4300	0.3939	7D3	0.4359	0.3960	7D4	0.4316	0.3873
	0.4300	0.3939		0.4342	0.4028		0.4403	0.4049		0.4359	0.3960
	0.4359	0.3960		0.4403	0.4049		0.4465	0.4071		0.4418	0.3981
	0.4316	0.3873		0.4359	0.3960		0.4418	0.3981		0.4373	0.3893
8A1	0.4373	0.3893	8A2	0.4418	0.3981	8A3	0.4475	0.3994	8A4	0.4428	0.3906
	0.4418	0.3981		0.4465	0.4071		0.4523	0.4085		0.4475	0.3994
	0.4475	0.3994		0.4523	0.4085		0.4582	0.4099		0.4532	0.4008
	0.4428	0.3906		0.4475	0.3994		0.4532	0.4008		0.4483	0.3919
8B1	0.4465	0.4071	8B2	0.4513	0.4164	8B3	0.4573	0.4178	8B4	0.4523	0.4085
	0.4513	0.4164		0.4562	0.4260		0.4624	0.4274		0.4573	0.4178
	0.4573	0.4178		0.4624	0.4274		0.4687	0.4289		0.4634	0.4193
	0.4523	0.4085		0.4573	0.4178		0.4634	0.4193		0.4582	0.4099
8C1	0.4582	0.4099	8C2	0.4634	0.4193	8C3	0.4695	0.4207	8C4	0.4641	0.4112
	0.4634	0.4193		0.4687	0.4289		0.4750	0.4304		0.4695	0.4207
	0.4695	0.4207		0.4750	0.4304		0.4813	0.4319		0.4756	0.4221
	0.4641	0.4112		0.4695	0.4207		0.4756	0.4221		0.4700	0.4126
8D1	0.4483	0.3919	8D2	0.4532	0.4008	8D3	0.4589	0.4021	8D4	0.4538	0.3931
	0.4532	0.4008		0.4582	0.4099		0.4641	0.4112		0.4589	0.4021
	0.4589	0.4021		0.4641	0.4112		0.4700	0.4126		0.4646	0.4034
	0.4538	0.3931		0.4589	0.4021		0.4646	0.4034		0.4593	0.3944

CREE'S STANDARD COOL WHITE KITS PLOTTED ON ANSI STANDARD CHROMATICITY REGIONS

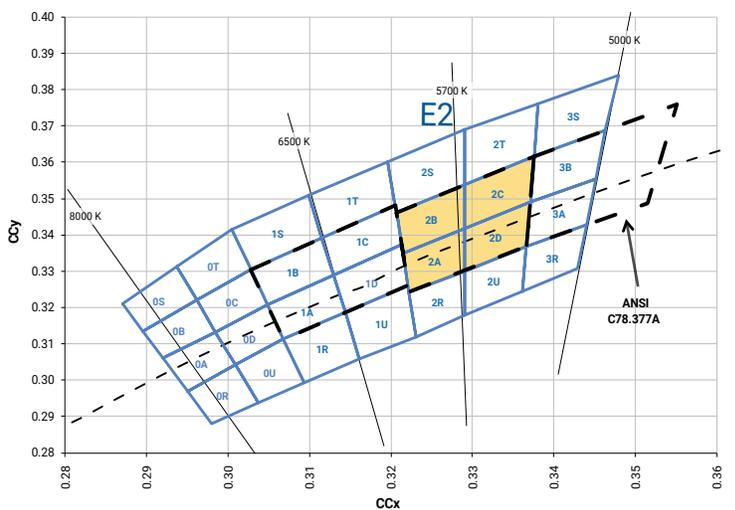
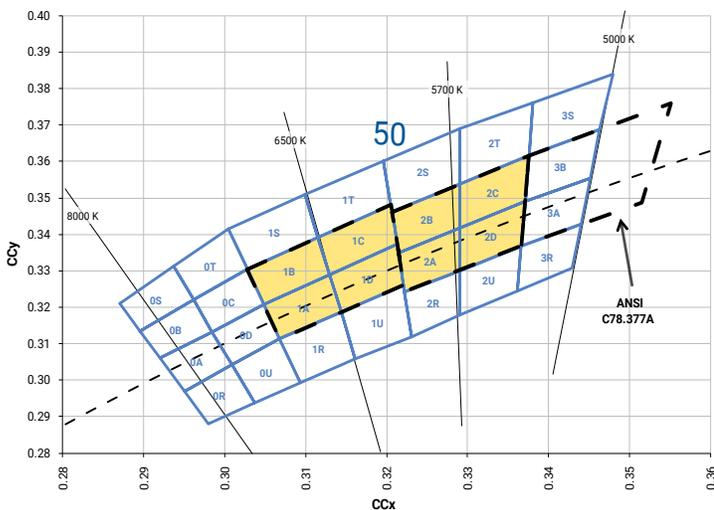
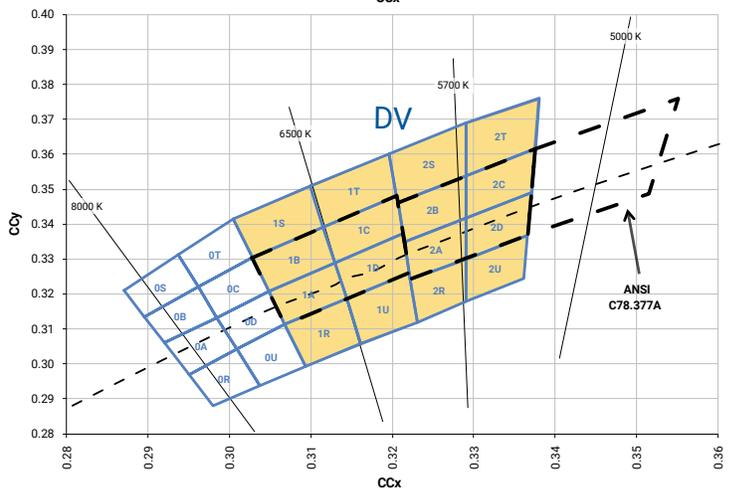
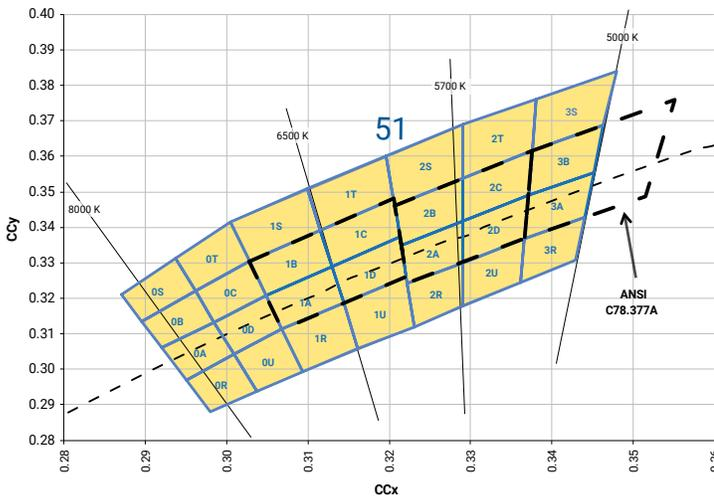
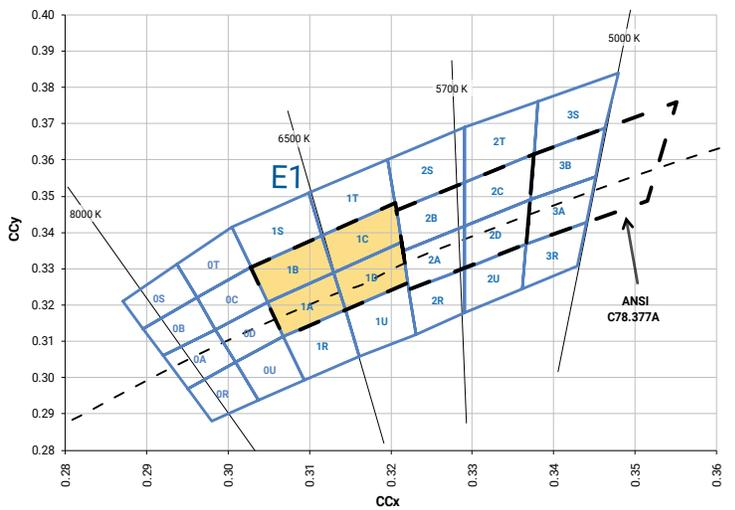
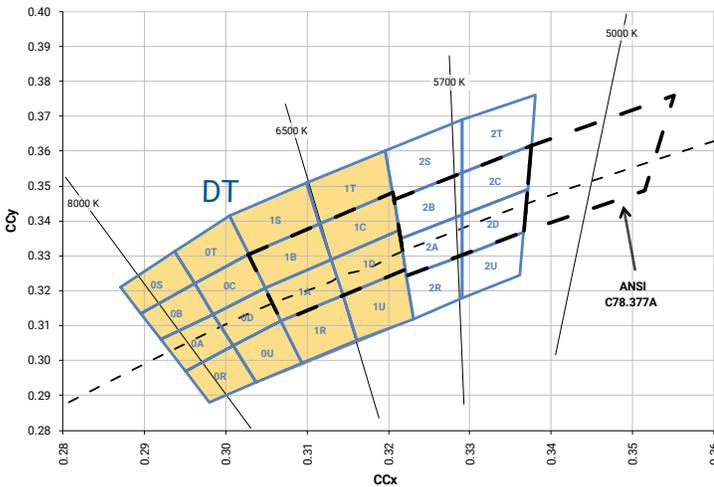

CREE'S STANDARD COOL WHITE KITS PLOTTED ON ANSI STANDARD CHROMATICITY REGIONS - CONTINUED

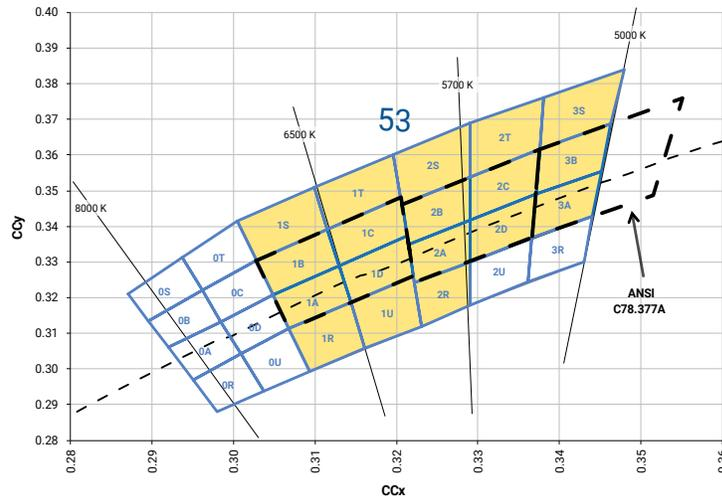

CREE'S STANDARD WARM AND NEUTRAL WHITE KITS PLOTTED ON ANSI STANDARD CHROMATICITY REGIONS

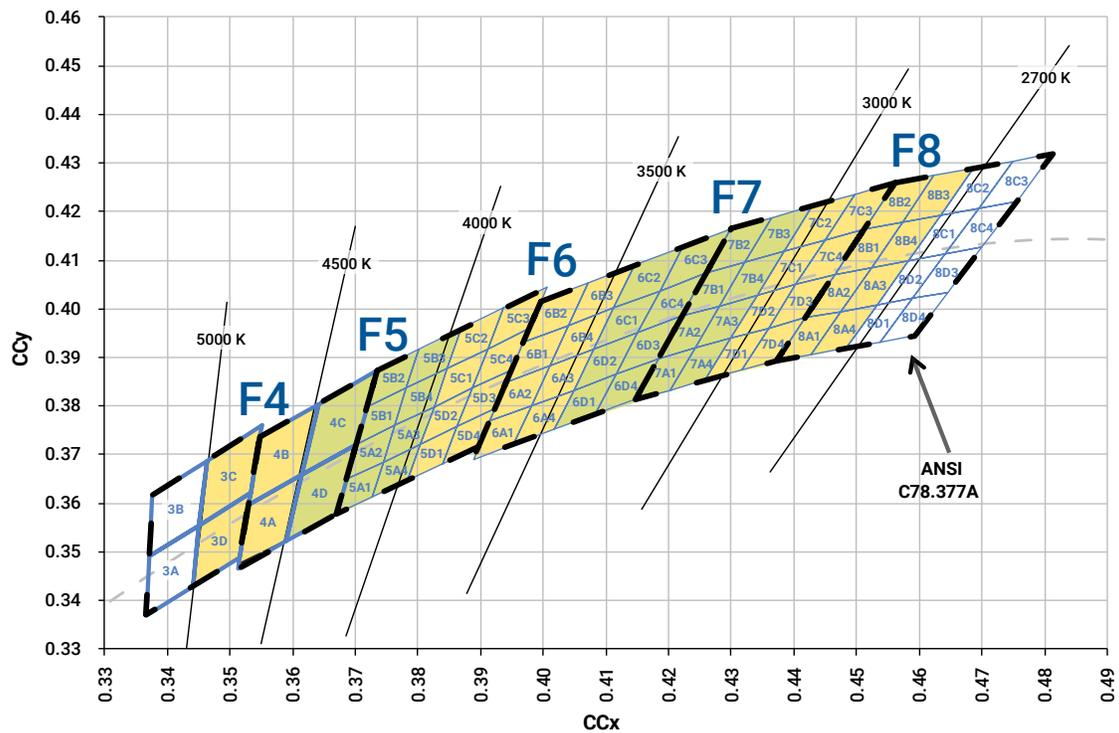
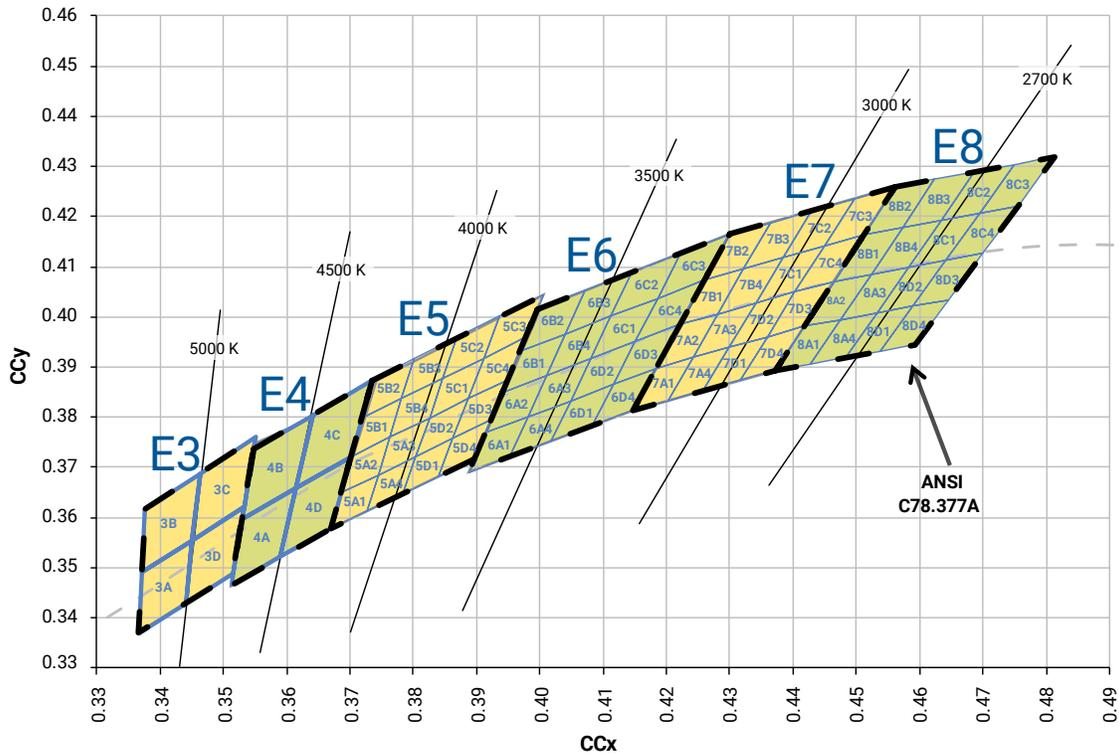

CREE'S STANDARD WARM AND NEUTRAL WHITE KITS PLOTTED ON ANSI STANDARD CHROMATICITY REGIONS - CONTINUED

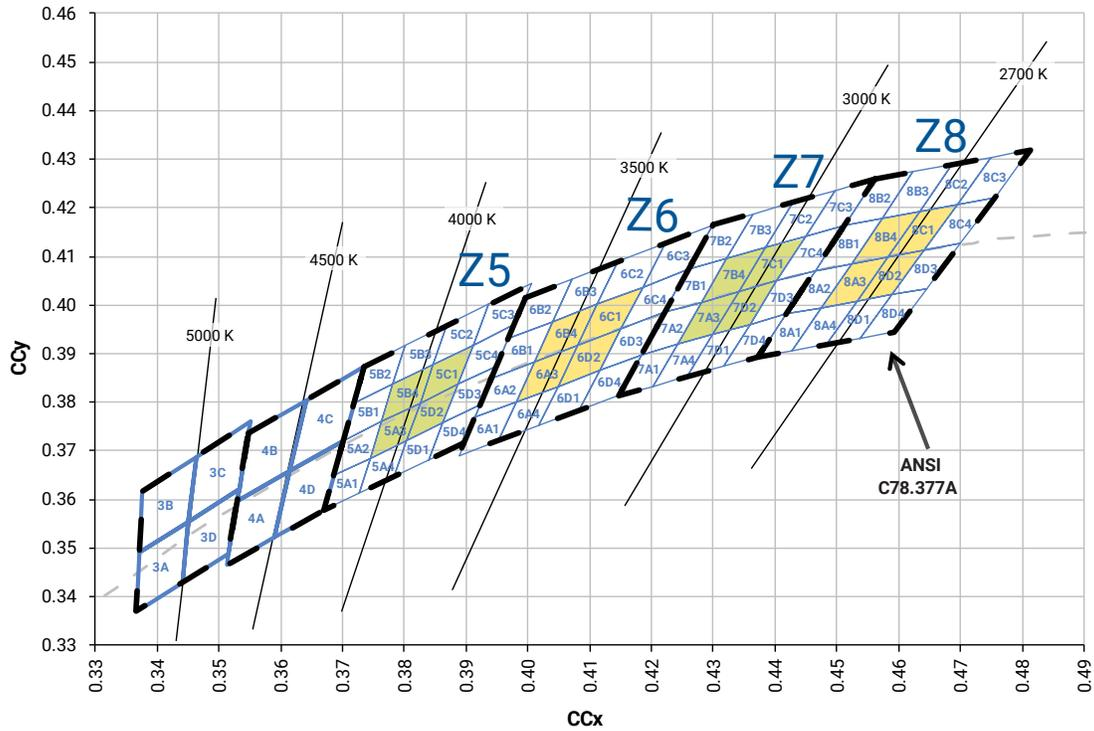

CREE'S STANDARD CHROMATICITY KITS

The following table provides the chromaticity bins associated with chromaticity kits.

Color	CCT	Kit	Chromaticity Bins
Cool White	7000 K	DT	0A, 0B, 0C, 0D, 0R, 0S, 0T, 0U, 1A, 1B, 1C, 1D, 1R, 1S, 1T, 1U
	6200 K	51	0A, 0B, 0C, 0D, 0R, 0S, 0T, 0U, 1A, 1B, 1C, 1D, 1R, 1S, 1T, 1U, 2A, 2B, 2C, 2D, 2R, 2S, 2T, 2U, 3A, 3B, 3R, 3S
	6000 K	53	1A, 1B, 1C, 1D, 1R, 1S, 1T, 1U, 2A, 2B, 2C, 2D, 2R, 2S, 2T, 3A, 3B, 3S
	6000 K	50	1A, 1B, 1C, 1D, 2A, 2B, 2C, 2D
	6500 K	E1	1A, 1B, 1C, 1D
	6000 K	DV	1A, 1B, 1C, 1D, 1R, 1S, 1T, 1U, 2A, 2B, 2C, 2D, 2R, 2S, 2T, 2U
	5700 K	E2	2A, 2B, 2C, 2D
Neutral White	5000 K	E3	3A, 3B, 3C, 3D
	4750 K	F4	3C, 3D, 4A, 4B
	4500 K	E4	4A, 4B, 4C, 4D
	4250 K	F5	4C, 4D, 5A1, 5A2, 5A3, 5A4, 5B1, 5B2, 5B3, 5B4
	4000 K	E5	5A1, 5A2, 5A3, 5A4, 5B1, 5B2, 5B3, 5B4, 5C1, 5C2, 5C3, 5C4, 5D1, 5D2, 5D3, 5D4
	4000 K	Z5	5A3, 5B4, 5C1, 5D2
Warm White	3750 K	F6	5C1, 5C2, 5C3, 5C4, 5D1, 5D2, 5D3, 5D4, 6A1, 6A2, 6A3, 6A4, 6B1, 6B2, 6B3, 6B4
	3500 K	E6	6A1, 6A2, 6A3, 6A4, 6B1, 6B2, 6B3, 6B4, 6C1, 6C2, 6C3, 6C4, 6D1, 6D2, 6D3, 6D4
	3500 K	Z6	6A3, 6B4, 6C1, 6D2
	3250 K	F7	6C1, 6C2, 6C3, 6C4, 6D1, 6D2, 6D3, 6D4, 7A1, 7A2, 7A3, 7A4, 7B1, 7B2, 7B3, 7B4
	3000 K	E7	7A1, 7A2, 7A3, 7A4, 7B1, 7B2, 7B3, 7B4, 7C1, 7C2, 7C3, 7C4, 7D1, 7D2, 7D3, 7D4
	3000 K	Z7	7A3, 7B4, 7C1, 7D2
	2850 K	F8	7C1, 7C2, 7C3, 7C4, 7D1, 7D2, 7D3, 7D4, 8A1, 8A2, 8A3, 8A4, 8B1, 8B2, 8B3, 8B4
	2700 K	E8	8A1, 8A2, 8A3, 8A4, 8B1, 8B2, 8B3, 8B4, 8C1, 8C2, 8C3, 8C4, 8D1, 8D2, 8D3, 8D4
	2700 K	Z8	8A3, 8B4, 8C1, 8D2

BIN AND ORDER CODE FORMATS

XP-G2 bin codes and order codes are configured in the following manner:

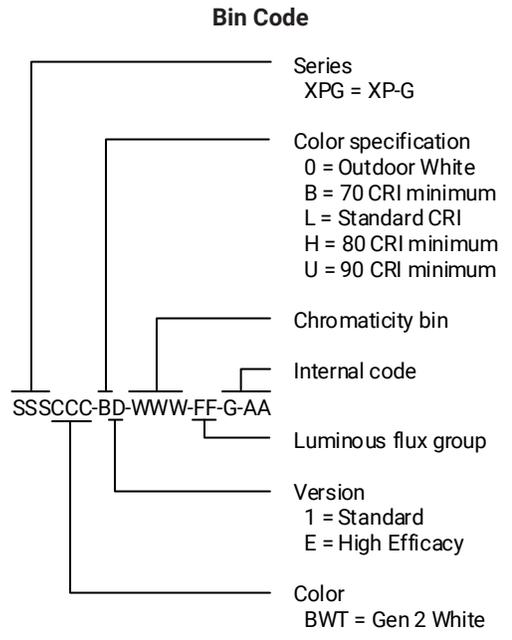
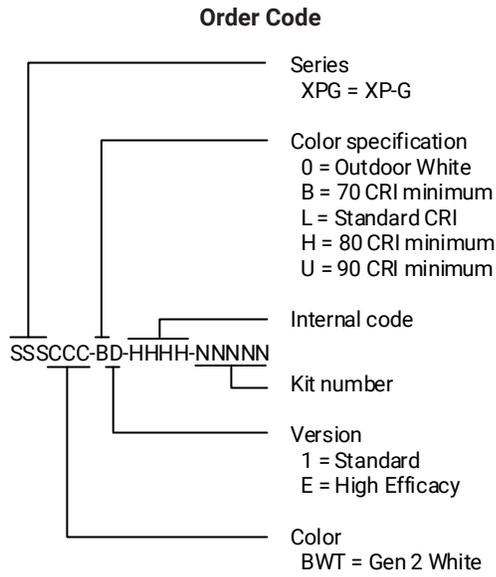

REFLOW SOLDERING CHARACTERISTICS

In testing, Cree has found XLamp XP-G2 LEDs to be compatible with JEDEC J-STD-020C, using the parameters listed below. As a general guideline, Cree recommends that users follow the recommended soldering profile provided by the manufacturer of the solder paste used, and therefore it is the lamp or luminaire manufacturer’s responsibility to determine applicable soldering requirements.

Note that this general guideline may not apply to all PCB designs and configurations of reflow soldering equipment.

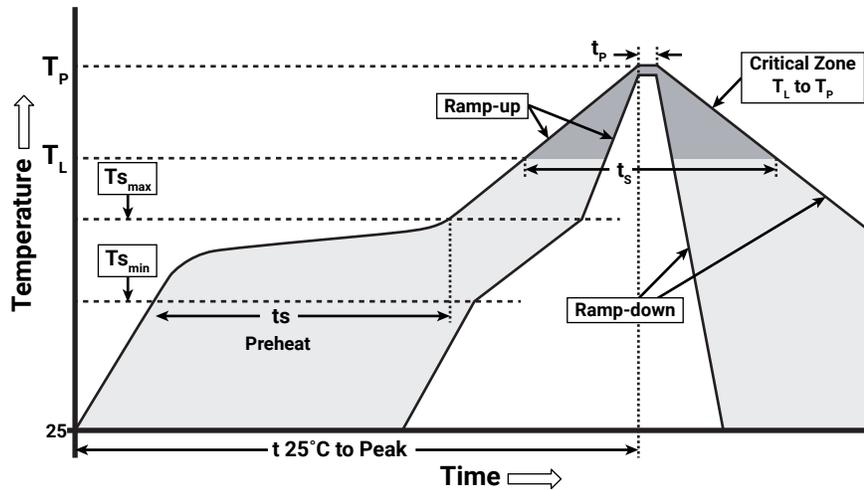

IPC/JEDEC J-STD-020C

Profile Feature	Lead-Free Solder
Average Ramp-Up Rate ($T_{s_{max}}$ to T_P)	1.2 °C/second
Preheat: Temperature Min ($T_{s_{min}}$)	120 °C
Preheat: Temperature Max ($T_{s_{max}}$)	170 °C
Preheat: Time ($t_{s_{min}}$ to $t_{s_{max}}$)	65-150 seconds
Time Maintained Above: Temperature (T_L)	217 °C
Time Maintained Above: Time (t_s)	45-90 seconds
Peak/Classification Temperature (T_P)	235 - 245 °C
Time Within 5 °C of Actual Peak Temperature (t_p)	20-40 seconds
Ramp-Down Rate	1 - 6 °C/second
Time 25 °C to Peak Temperature	4 minutes max.

Note: All temperatures refer to topside of the package, measured on the package body surface.

NOTES

Measurements

The luminous flux, radiant power, chromaticity, forward voltage and CRI measurements in this document are binning specifications only and solely represent product measurements as of the date of shipment. These measurements will change over time based on a number of factors that are not within Cree's control and are not intended or provided as operational specifications for the products. Calculated values are provided for informational purposes only and are not intended or provided as specifications.

Pre-Release Qualification Testing

Please read the [LED Reliability Overview](#) for details of the qualification process Cree applies to ensure long-term reliability for XLamp LEDs and details of Cree's pre-release qualification testing for XLamp LEDs.

Lumen Maintenance

Cree now uses standardized IES LM-80-08 and TM-21-11 methods for collecting long-term data and extrapolating LED lumen maintenance. For information on the specific LM-80 data sets available for this LED, refer to the public [LM-80 results document](#).

Please read the [Long-Term Lumen Maintenance application note](#) for more details on Cree's lumen maintenance testing and forecasting. Please read the [Thermal Management application note](#) for details on how thermal design, ambient temperature, and drive current affect the LED junction temperature.

Moisture Sensitivity

Cree recommends keeping XLamp LEDs in the provided, resealable moisture-barrier packaging (MBP) until immediately prior to soldering. Unopened MBPs that contain XLamp LEDs do not need special storage for moisture sensitivity.

Once the MBP is opened, XLamp XP-G2 LEDs may be stored as MSL 1 per JEDEC J-STD-033, meaning they have unlimited floor life in conditions of ≤ 30 °C/85% relative humidity (RH). Regardless of the storage condition, Cree recommends sealing any unsoldered LEDs in the original MBP.

RoHS Compliance

The levels of RoHS restricted materials in this product are below the maximum concentration values (also referred to as the threshold limits) permitted for such substances, or are used in an exempted application, in accordance with EU Directive 2011/65/EC (RoHS2), as implemented January 2, 2013. RoHS Declarations for this product can be obtained from your Cree representative or from the [Product Ecology](#) section of the Cree website.

REACH Compliance

REACH substances of very high concern (SVHCs) information is available for this product. Since the European Chemical Agency (ECHA) has published notice of their intent to frequently revise the SVHC listing for the foreseeable future, please contact a Cree representative to insure you get the most up-to-date REACH Declaration. REACH banned substance information (REACH Article 67) is also available upon request.

NOTES - CONTINUED

UL® Recognized Component

This product meets the requirements to be considered a UL Recognized Component with Level 4 enclosure consideration. The LED package or a portion thereof has been investigated as a fire and electrical enclosure per ANSI/UL 8750.

Vision Advisory

WARNING: Do not look at an exposed lamp in operation. Eye injury can result. For more information about LEDs and eye safety, please refer to the [LED Eye Safety application note](#).

MECHANICAL DIMENSIONS ($T_A = 25\text{ }^\circ\text{C}$)

Thermal vias, if present, are not shown on these drawings.

All measurements are $\pm .13\text{ mm}$ unless otherwise indicated.

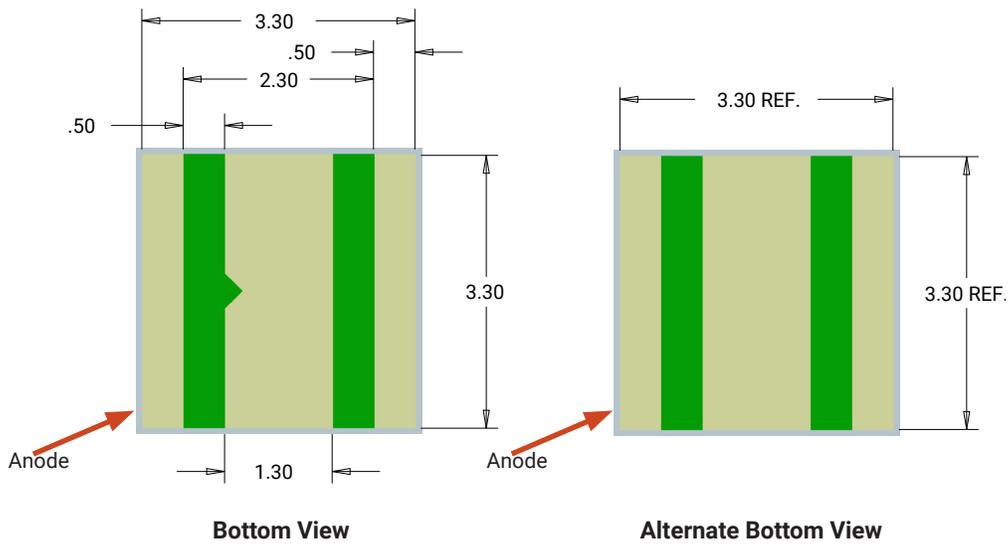
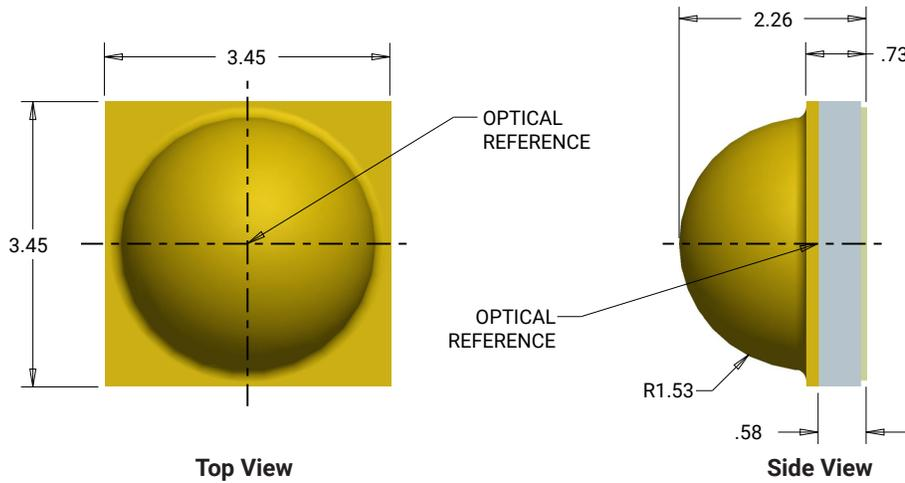

MECHANICAL DIMENSIONS (T_A = 25 °C) - CONTINUED

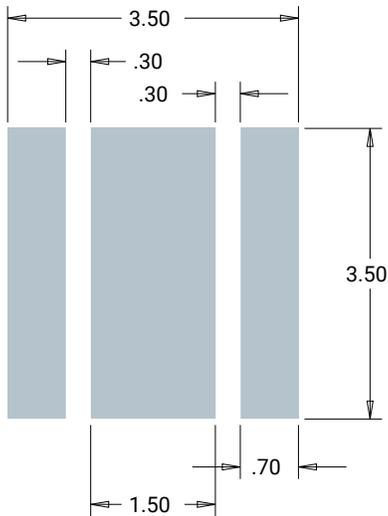

Recommended Copper Layout

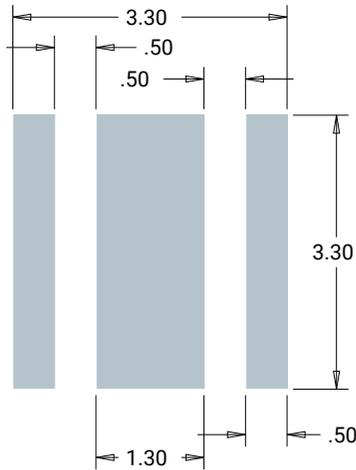

Recommended Solder Pad
(Solder Mask Pattern)

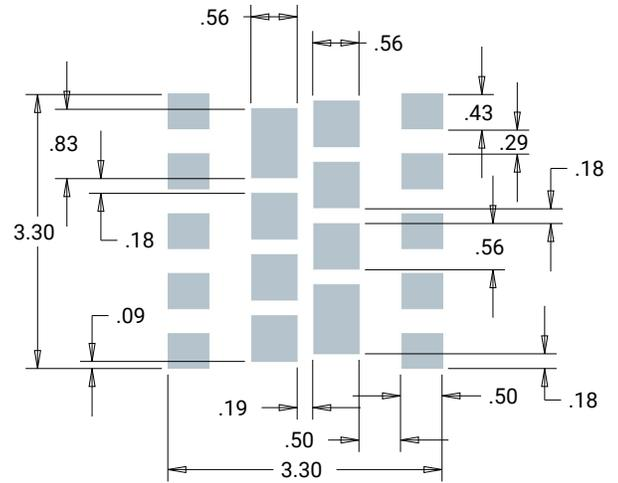

Recommended Stencil Openings*

Notes:

- Cree recommends using thermal pad kickouts to maximize component thermal performance.
- Cree recommends using white solder mask material to minimize system optical loss.
- * This stencil has been tested and optimized for the avoidance of voiding when using ALPHA® LUMET® P30 Maxrel solder paste. For other solder pastes, a “window pane” design for the thermal pad stencil may result in a lower voiding percentage. Contact your local Cree Field Applications Engineer for consultation regarding your specific application.

TAPE AND REEL

All Cree carrier tapes conform to EIA-481D, Automated Component Handling Systems Standard.

All dimensions in mm.

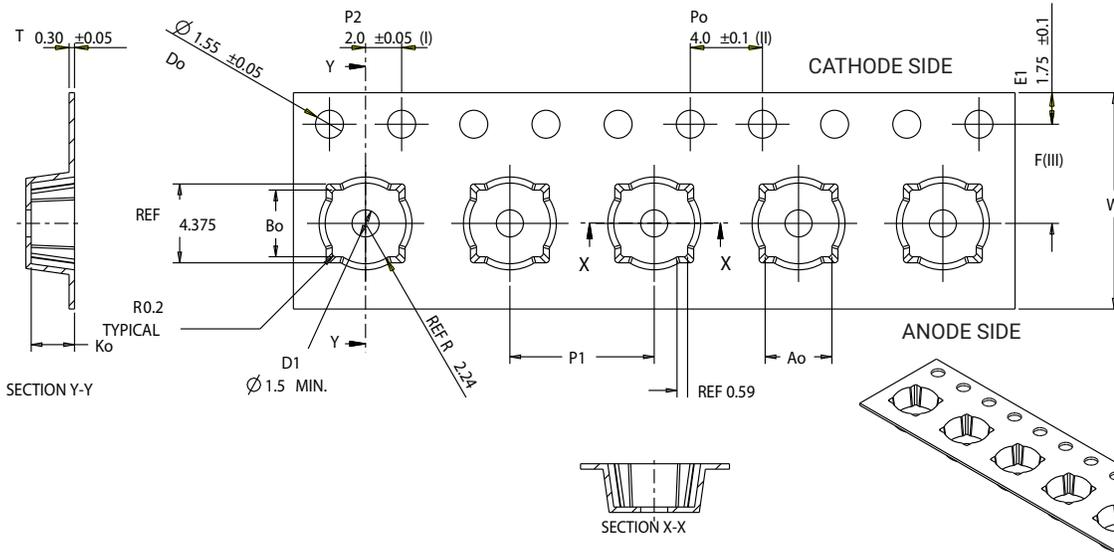

Ao	3.70	+/- 0.1
Bo	3.70	+/- 0.1
Ko	2.40	+0.0/-0.1
F	5.50	+/- 0.05
P 1	8.00	+/- 0.1
W	12.00	+0.3/-0.1

- (I) Measured from centerline of sprocket hole to centerline of pocket.
- (II) Cumulative tolerance of 10 sprocket holes is ±0.20.
- (III) Measured from centerline of sprocket hole to centerline of pocket.
- (IV) Other material available.

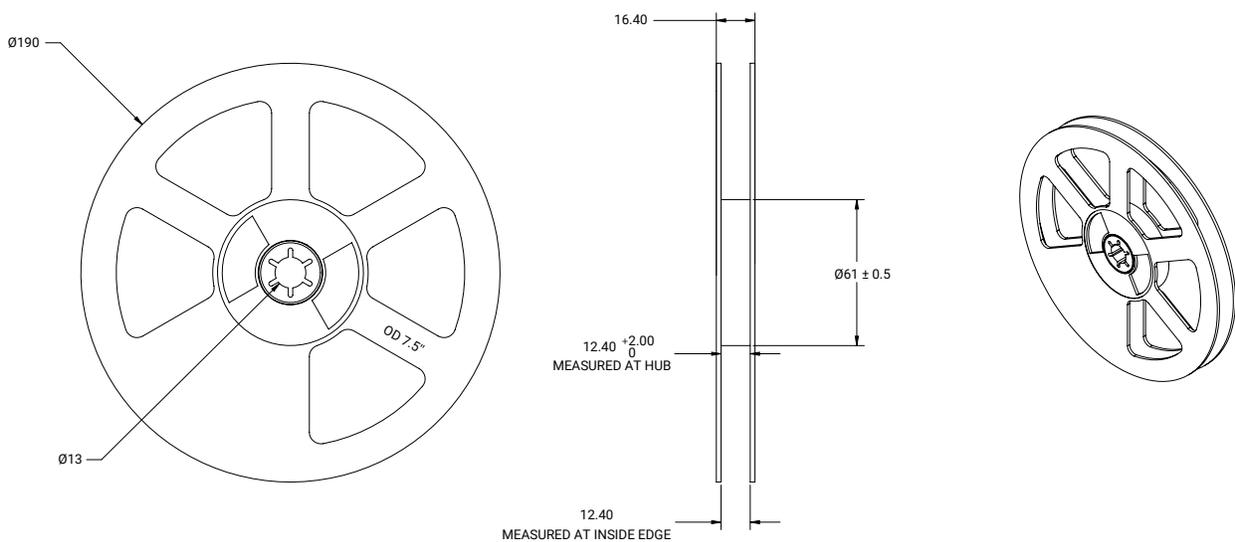
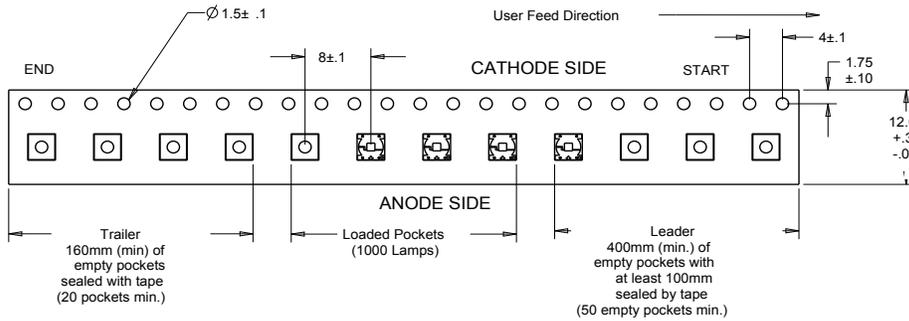

PACKAGING

Unpackaged Reel

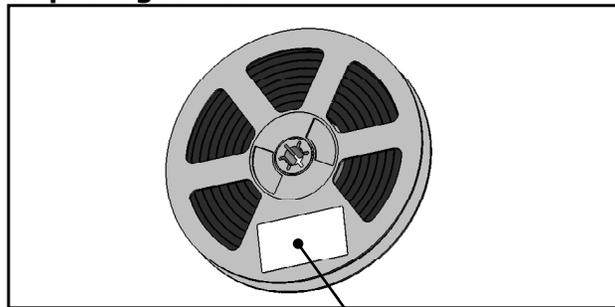

Label with Cree Bin Code,
Quantity, Reel ID

Packaged Reel

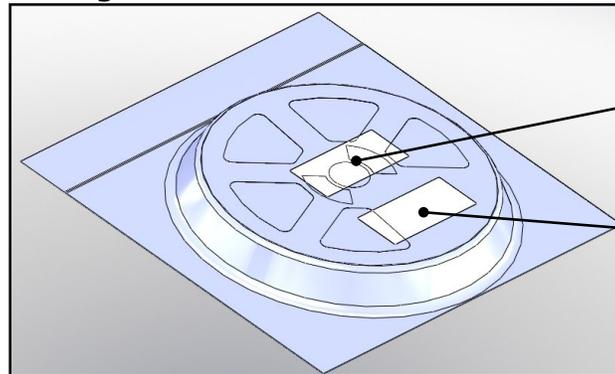

Label with Cree Order Code,
Quantity, Reel ID, PO #

Label with Cree Bin Code,
Quantity, Reel ID

Boxed Reel

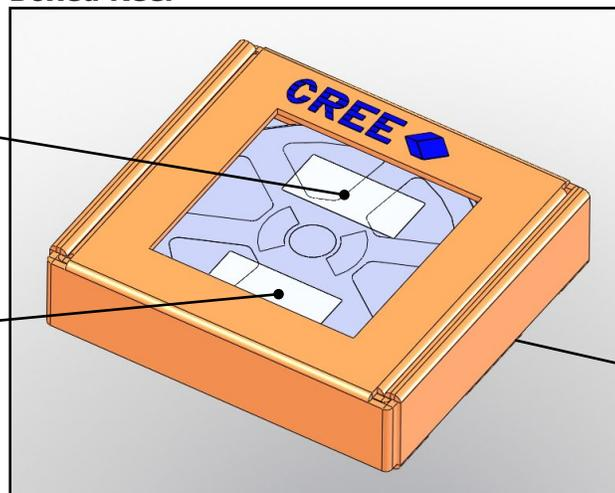

Label with Cree Order Code,
Quantity, Reel ID, PO #

Label with Cree Bin Code,
Quantity, Reel ID

Patent Label
(on bottom of box)



Компания «ЭлектроПласт» предлагает заключение долгосрочных отношений при поставках импортных электронных компонентов на взаимовыгодных условиях!

Наши преимущества:

- Оперативные поставки широкого спектра электронных компонентов отечественного и импортного производства напрямую от производителей и с крупнейших мировых складов;
- Поставка более 17-ти миллионов наименований электронных компонентов;
- Поставка сложных, дефицитных, либо снятых с производства позиций;
- Оперативные сроки поставки под заказ (от 5 рабочих дней);
- Экспресс доставка в любую точку России;
- Техническая поддержка проекта, помощь в подборе аналогов, поставка прототипов;
- Система менеджмента качества сертифицирована по Международному стандарту ISO 9001;
- Лицензия ФСБ на осуществление работ с использованием сведений, составляющих государственную тайну;
- Поставка специализированных компонентов (Xilinx, Altera, Analog Devices, Intersil, Interpoint, Microsemi, Aeroflex, Peregrine, Syfer, Eurofarad, Texas Instrument, Miteq, Cobham, E2V, MA-COM, Hittite, Mini-Circuits, General Dynamics и др.);

Помимо этого, одним из направлений компании «ЭлектроПласт» является направление «Источники питания». Мы предлагаем Вам помощь Конструкторского отдела:

- Подбор оптимального решения, техническое обоснование при выборе компонента;
- Подбор аналогов;
- Консультации по применению компонента;
- Поставка образцов и прототипов;
- Техническая поддержка проекта;
- Защита от снятия компонента с производства.



Как с нами связаться

Телефон: 8 (812) 309 58 32 (многоканальный)

Факс: 8 (812) 320-02-42

Электронная почта: org@eplast1.ru

Адрес: 198099, г. Санкт-Петербург, ул. Калинина, дом 2, корпус 4, литера А.