

## Cree® XLamp® XP-G2 LEDs



**XP-G2 Standard LED**



**XP-G2 High Efficacy LED**

### PRODUCT DESCRIPTION

The original XLamp® XP-G2 LED pioneered a broad set of LED applications for the industry, including outdoor and area lighting, and has since served as a preferred choice by manufacturers that require advanced output, efficacy and optical control. The compact and proven 3.45-mm XP platform has an excellent ecosystem of optics and system solutions available, enabling lighting manufacturers to simplify their design process and shorten time to market.

XP-G2 LEDs are now available in two different White versions: Standard and High Efficacy (HE). XP-G2 Standard is the same breakthrough product that enabled a broad set of new LED applications for ceramic high-power LEDs.

The new High Efficacy version extends this legacy with a drop-in upgrade for existing designs optimized around XP-G2 LEDs. XP-G2 HE LEDs leverage Cree's latest high-power chip technology to deliver 25 percent more light output via a higher maximum current of 2000 mA and higher efficacy and lower thermal resistance.

### FEATURES

- Available in white, outdoor white and 80-, 85- and 90-CRI white
- ANSI-compatible chromaticity bins
- Binned at 85 °C
- Maximum drive current: Standard: 1500 mA, HE: 2000 mA
- Low thermal resistance: Standard: 4 °C/W, HE: 3 °C/W
- Wide viewing angle: Standard: 120°, HE: 125°
- Unlimited floor life at ≤ 30 °C/85% RH
- Reflow solderable - JEDEC J-STD-020C
- Electrically neutral thermal path
- RoHS and REACH compliant
- UL® recognized component (E349212)



**TABLE OF CONTENTS**

---

|                                                                                                |    |
|------------------------------------------------------------------------------------------------|----|
| Characteristics .....                                                                          | 3  |
| Flux Characteristics - High Efficacy .....                                                     | 4  |
| Flux Characteristics - Standard .....                                                          | 9  |
| Relative Spectral Power Distribution .....                                                     | 15 |
| Relative Flux vs. Junction Temperature.....                                                    | 15 |
| Electrical Characteristics - High Efficacy.....                                                | 16 |
| Electrical Characteristics - Standard .....                                                    | 16 |
| Relative Flux vs. Current - High Efficacy.....                                                 | 17 |
| Relative Flux vs. Current - Standard .....                                                     | 17 |
| Relative Chromaticity vs Current and Temperature - High Efficacy.....                          | 18 |
| Relative Chromaticity vs Current and Temperature - Standard.....                               | 19 |
| Typical Spatial Distribution - High Efficacy.....                                              | 20 |
| Typical Spatial Distribution - Standard .....                                                  | 20 |
| Thermal Design - High Efficacy.....                                                            | 21 |
| Thermal Design - Standard.....                                                                 | 21 |
| Performance Groups – Luminous Flux.....                                                        | 22 |
| Performance Groups – Chromaticity.....                                                         | 23 |
| Cree’s Standard Cool White Kits Plotted on ANSI Standard Chromaticity Regions.....             | 26 |
| Cree’s Standard Warm and Neutral White Kits Plotted on ANSI Standard Chromaticity Regions..... | 28 |
| Cree’s Standard Chromaticity Kits .....                                                        | 30 |
| Bin and Order Code Formats.....                                                                | 31 |
| Reflow Soldering Characteristics.....                                                          | 32 |
| Notes .....                                                                                    | 33 |
| Mechanical Dimensions .....                                                                    | 35 |
| Tape and Reel.....                                                                             | 37 |
| Packaging.....                                                                                 | 38 |

**CHARACTERISTICS**

| Characteristics                                              | Unit    | Minimum | Typical | Maximum |
|--------------------------------------------------------------|---------|---------|---------|---------|
| Thermal resistance, junction to solder point - High Efficacy | °C/W    |         | 3       |         |
| Thermal resistance, junction to solder point - Standard      | °C/W    |         | 4       |         |
| Viewing angle (FWHM) - High Efficacy                         | degrees |         | 125     |         |
| Viewing angle (FWHM) - Standard                              | degrees |         | 120     |         |
| Temperature coefficient of voltage - High Efficacy           | mV/°C   |         | -1.3    |         |
| Temperature coefficient of voltage - Standard                | mV/°C   |         | -1.4    |         |
| ESD withstand voltage (HBM per Mil-Std-883D)                 | V       |         |         | 8000    |
| DC forward current - High Efficacy                           | mA      |         |         | 2000    |
| DC forward current - Standard                                | mA      |         |         | 1500    |
| Reverse voltage                                              | V       |         |         | 5       |
| Forward voltage (@ 350 mA, 85 °C) - High Efficacy            | V       |         | 2.70    | 2.90    |
| Forward voltage (@ 350 mA, 85 °C) - Standard                 | V       |         | 2.74    | 3.1     |
| Forward voltage (@ 700 mA, 85 °C) - High Efficacy            | V       |         | 2.80    |         |
| Forward voltage (@ 700 mA, 85 °C) - Standard                 | V       |         | 2.85    |         |
| Forward voltage (@ 1000 mA, 85 °C) - High Efficacy           | V       |         | 2.87    |         |
| Forward voltage (@ 1000 mA, 85 °C) - Standard                | V       |         | 2.93    |         |
| Forward voltage (@ 1500 mA, 85 °C) - High Efficacy           | V       |         | 2.97    |         |
| Forward voltage (@ 1500 mA, 85 °C) - Standard                | V       |         | 3.1     |         |
| LED junction temperature                                     | °C      |         |         | 150     |

## FLUX CHARACTERISTICS - HIGH EFFICACY ( $T_j = 85\text{ }^\circ\text{C}$ )

The following table provides order codes for XLamp High-Efficacy XP-G2 LEDs. For a complete description of the order code nomenclature, please see the Bin and Order Code Formats section (page 31). For definitions of the chromaticity kits, please see the Cree's Standard Chromaticity Kits section (page 30).

| Chromaticity |        | Minimum Luminous Flux (lm)<br>@ 350 mA |                      |                       | Order Codes          |                      |                      |
|--------------|--------|----------------------------------------|----------------------|-----------------------|----------------------|----------------------|----------------------|
| Kit          | CCT    | Code                                   | Flux (lm) @<br>85 °C | Flux (lm) @<br>25 °C* | 70 CRI Minimum       | 80 CRI Minimum       | 90 CRI Minimum       |
| DT           | 7000 K | S4                                     | 164                  | 180                   | XPGBWT-BE-0000-00LDT |                      |                      |
|              |        | S3                                     | 156                  | 171                   | XPGBWT-BE-0000-00KDT | XPGBWT-HE-0000-00KDT |                      |
|              |        | S2                                     | 148                  | 163                   | XPGBWT-BE-0000-00JDT | XPGBWT-HE-0000-00JDT |                      |
|              |        | R5                                     | 139                  | 153                   |                      | XPGBWT-HE-0000-00HDT |                      |
| E1           | 6500 K | S4                                     | 164                  | 180                   | XPGBWT-BE-0000-00LE1 |                      |                      |
|              |        | S3                                     | 156                  | 171                   | XPGBWT-BE-0000-00KE1 | XPGBWT-HE-0000-00KE1 |                      |
|              |        | S2                                     | 148                  | 163                   | XPGBWT-BE-0000-00JE1 | XPGBWT-HE-0000-00JE1 |                      |
|              |        | R5                                     | 139                  | 153                   |                      | XPGBWT-HE-0000-00HE1 |                      |
| 51           | 6200 K | S4                                     | 164                  | 180                   | XPGBWT-BE-0000-00L51 |                      |                      |
|              |        | S3                                     | 156                  | 171                   | XPGBWT-BE-0000-00K51 | XPGBWT-HE-0000-00K51 |                      |
|              |        | S2                                     | 148                  | 163                   | XPGBWT-BE-0000-00J51 | XPGBWT-HE-0000-00J51 |                      |
|              |        | R5                                     | 139                  | 153                   |                      | XPGBWT-HE-0000-00H51 |                      |
|              |        | R4                                     | 130                  | 143                   |                      |                      |                      |
|              |        | R3                                     | 122                  | 134                   |                      |                      | XPGBWT-UE-0000-00F51 |
|              |        | R2                                     | 114                  | 125                   |                      |                      | XPGBWT-UE-0000-00E51 |
| DV           | 6000 K | S4                                     | 164                  | 180                   | XPGBWT-BE-0000-00LDV |                      |                      |
|              |        | S3                                     | 156                  | 171                   | XPGBWT-BE-0000-00KDV | XPGBWT-HE-0000-00KDV |                      |
|              |        | S2                                     | 148                  | 163                   | XPGBWT-BE-0000-00JDV | XPGBWT-HE-0000-00JDV |                      |
|              |        | R5                                     | 139                  | 153                   |                      | XPGBWT-HE-0000-00HDV |                      |
|              |        | R4                                     | 130                  | 143                   |                      |                      |                      |
|              |        | R3                                     | 122                  | 134                   |                      |                      | XPGBWT-UE-0000-00FDV |
|              |        | R2                                     | 114                  | 125                   |                      |                      | XPGBWT-UE-0000-00EDV |

### Notes

- Cree maintains a tolerance of  $\pm 7\%$  on flux and power measurements,  $\pm 0.005$  on chromaticity (CCx, CCy) measurements and a tolerance of  $\pm 2$  on CRI measurements. See the Measurements section (page 33).
- Cree XLamp XP-G2 LED order codes specify only a minimum flux bin and not a maximum. Cree may ship reels in flux bins higher than the minimum specified by the order code without advance notice. Shipments will always adhere to the chromaticity bin restrictions specified by the order code.
- \* Flux values @ 25 °C are calculated and for reference only.

**FLUX CHARACTERISTICS - HIGH EFFICACY ( $T_j = 85\text{ }^\circ\text{C}$ ) - CONTINUED**

| Chromaticity |        | Minimum Luminous Flux (lm)<br>@ 350 mA |                      |                       | Order Codes          |                      |                      |
|--------------|--------|----------------------------------------|----------------------|-----------------------|----------------------|----------------------|----------------------|
| Kit          | CCT    | Code                                   | Flux (lm) @<br>85 °C | Flux (lm) @<br>25 °C* | 70 CRI Minimum       | 80 CRI Minimum       | 90 CRI Minimum       |
| 50           | 6000 K | S4                                     | 164                  | 180                   | XPGBWT-BE-0000-00L50 |                      |                      |
|              |        | S3                                     | 156                  | 171                   | XPGBWT-BE-0000-00K50 | XPGBWT-HE-0000-00K50 |                      |
|              |        | S2                                     | 148                  | 163                   | XPGBWT-BE-0000-00J50 | XPGBWT-HE-0000-00J50 |                      |
|              |        | R5                                     | 139                  | 153                   |                      | XPGBWT-HE-0000-00H50 |                      |
|              |        | R4                                     | 130                  | 143                   |                      |                      |                      |
|              |        | R3                                     | 122                  | 134                   |                      |                      | XPGBWT-UE-0000-00F50 |
|              |        | R2                                     | 114                  | 125                   |                      |                      | XPGBWT-UE-0000-00E50 |
| E2           | 5700 K | S4                                     | 164                  | 180                   | XPGBWT-BE-0000-00LE2 |                      |                      |
|              |        | S3                                     | 156                  | 171                   | XPGBWT-BE-0000-00KE2 | XPGBWT-HE-0000-00KE2 |                      |
|              |        | S2                                     | 148                  | 163                   | XPGBWT-BE-0000-00JE2 | XPGBWT-HE-0000-00JE2 |                      |
|              |        | R5                                     | 139                  | 153                   |                      | XPGBWT-HE-0000-00HE2 |                      |
|              |        | R4                                     | 130                  | 143                   |                      |                      | XPGBWT-UE-0000-00GE2 |
|              |        | R3                                     | 122                  | 134                   |                      |                      | XPGBWT-UE-0000-00FE2 |
|              |        | R2                                     | 114                  | 125                   |                      |                      | XPGBWT-UE-0000-00EE2 |
| E3           | 5000 K | S4                                     | 164                  | 180                   | XPGBWT-BE-0000-00LE3 |                      |                      |
|              |        | S3                                     | 156                  | 171                   | XPGBWT-BE-0000-00KE3 | XPGBWT-HE-0000-00KE3 |                      |
|              |        | S2                                     | 148                  | 163                   | XPGBWT-BE-0000-00JE3 | XPGBWT-HE-0000-00JE3 |                      |
|              |        | R5                                     | 139                  | 153                   |                      | XPGBWT-HE-0000-00HE3 |                      |
|              |        | R4                                     | 130                  | 143                   |                      |                      |                      |
|              |        | R3                                     | 122                  | 134                   |                      |                      | XPGBWT-UE-0000-00FE3 |
|              |        | R2                                     | 114                  | 125                   |                      |                      | XPGBWT-UE-0000-00EE3 |
| F4           | 4750 K | S4                                     | 164                  | 180                   | XPGBWT-BE-0000-00LF4 |                      |                      |
|              |        | S3                                     | 156                  | 171                   | XPGBWT-BE-0000-00KF4 | XPGBWT-HE-0000-00KF4 |                      |
|              |        | S2                                     | 148                  | 163                   | XPGBWT-BE-0000-00JF4 | XPGBWT-HE-0000-00JF4 |                      |
|              |        | R5                                     | 139                  | 153                   |                      | XPGBWT-HE-0000-00HF4 |                      |
|              |        | R4                                     | 130                  | 143                   |                      |                      |                      |
|              |        | R3                                     | 122                  | 134                   |                      |                      | XPGBWT-UE-0000-00FF4 |
|              |        | R2                                     | 114                  | 125                   |                      |                      | XPGBWT-UE-0000-00EF4 |
|              |        | Q5                                     | 107                  | 118                   |                      |                      | XPGBWT-UE-0000-00DF4 |

**Notes**

- Cree maintains a tolerance of  $\pm 7\%$  on flux and power measurements,  $\pm 0.005$  on chromaticity (CCx, CCy) measurements and a tolerance of  $\pm 2$  on CRI measurements. See the Measurements section (page 33).
- Cree XLamp XP-G2 LED order codes specify only a minimum flux bin and not a maximum. Cree may ship reels in flux bins higher than the minimum specified by the order code without advance notice. Shipments will always adhere to the chromaticity bin restrictions specified by the order code.
- \* Flux values @ 25 °C are calculated and for reference only.

**FLUX CHARACTERISTICS - HIGH EFFICACY (T<sub>j</sub> = 85 °C) - CONTINUED**

| Chromaticity |        | Minimum Luminous Flux (lm)<br>@ 350 mA |                      |                       | Order Codes          |                      |                      |
|--------------|--------|----------------------------------------|----------------------|-----------------------|----------------------|----------------------|----------------------|
| Kit          | CCT    | Code                                   | Flux (lm) @<br>85 °C | Flux (lm) @<br>25 °C* | 70 CRI Minimum       | 80 CRI Minimum       | 90 CRI Minimum       |
| E4           | 4500 K | S4                                     | 164                  | 180                   | XPGBWT-BE-0000-00LE4 |                      |                      |
|              |        | S3                                     | 156                  | 171                   | XPGBWT-BE-0000-00KE4 | XPGBWT-HE-0000-00KE4 |                      |
|              |        | S2                                     | 148                  | 163                   | XPGBWT-BE-0000-00JE4 | XPGBWT-HE-0000-00JE4 |                      |
|              |        | R5                                     | 139                  | 153                   |                      | XPGBWT-HE-0000-00HE4 |                      |
|              |        | R4                                     | 130                  | 143                   |                      |                      |                      |
|              |        | R3                                     | 122                  | 134                   |                      |                      | XPGBWT-UE-0000-00FE4 |
|              |        | R2                                     | 114                  | 125                   |                      |                      | XPGBWT-UE-0000-00EE4 |
|              |        | Q5                                     | 107                  | 118                   |                      |                      | XPGBWT-UE-0000-00DE4 |
| F5           | 4250 K | S4                                     | 164                  | 180                   | XPGBWT-BE-0000-00LF5 |                      |                      |
|              |        | S3                                     | 156                  | 171                   | XPGBWT-BE-0000-00KF5 | XPGBWT-HE-0000-00KF5 |                      |
|              |        | S2                                     | 148                  | 163                   | XPGBWT-BE-0000-00JF5 | XPGBWT-HE-0000-00JF5 |                      |
|              |        | R5                                     | 139                  | 153                   |                      | XPGBWT-HE-0000-00HF5 |                      |
|              |        | R4                                     | 130                  | 143                   |                      |                      |                      |
|              |        | R3                                     | 122                  | 134                   |                      |                      | XPGBWT-UE-0000-00FF5 |
|              |        | R2                                     | 114                  | 125                   |                      |                      | XPGBWT-UE-0000-00EF5 |
|              |        | Q5                                     | 107                  | 118                   |                      |                      | XPGBWT-UE-0000-00DF5 |
| E5           | 4000 K | S4                                     | 164                  | 180                   | XPGBWT-BE-0000-00LE5 |                      |                      |
|              |        | S3                                     | 156                  | 171                   | XPGBWT-BE-0000-00KE5 | XPGBWT-HE-0000-00KE5 |                      |
|              |        | S2                                     | 148                  | 163                   | XPGBWT-BE-0000-00JE5 | XPGBWT-HE-0000-00JE5 |                      |
|              |        | R5                                     | 139                  | 153                   |                      | XPGBWT-HE-0000-00HE5 |                      |
|              |        | R4                                     | 130                  | 143                   |                      |                      |                      |
|              |        | R3                                     | 122                  | 134                   |                      |                      | XPGBWT-UE-0000-00FE5 |
|              |        | R2                                     | 114                  | 125                   |                      |                      | XPGBWT-UE-0000-00EE5 |
|              |        | Q5                                     | 107                  | 118                   |                      |                      | XPGBWT-UE-0000-00DE5 |

**Notes**

- Cree maintains a tolerance of ±7% on flux and power measurements, ±0.005 on chromaticity (CCx, CCy) measurements and a tolerance of ±2 on CRI measurements. See the Measurements section (page 33).
- Cree XLamp XP-G2 LED order codes specify only a minimum flux bin and not a maximum. Cree may ship reels in flux bins higher than the minimum specified by the order code without advance notice. Shipments will always adhere to the chromaticity bin restrictions specified by the order code.
- \* Flux values @ 25 °C are calculated and for reference only.

**FLUX CHARACTERISTICS - HIGH EFFICACY ( $T_j = 85\text{ }^\circ\text{C}$ ) - CONTINUED**

| Chromaticity |        | Minimum Luminous Flux (lm)<br>@ 350 mA |                      |                       | Order Codes          |                      |                      |
|--------------|--------|----------------------------------------|----------------------|-----------------------|----------------------|----------------------|----------------------|
| Kit          | CCT    | Code                                   | Flux (lm) @<br>85 °C | Flux (lm) @<br>25 °C* | 70 CRI Minimum       | 80 CRI Minimum       | 90 CRI Minimum       |
| F6           | 3750 K | S4                                     | 164                  | 180                   | XPGBWT-BE-0000-00LF6 |                      |                      |
|              |        | S3                                     | 156                  | 171                   | XPGBWT-BE-0000-00KF6 |                      |                      |
|              |        | S2                                     | 148                  | 163                   | XPGBWT-BE-0000-00JF6 | XPGBWT-HE-0000-00JF6 |                      |
|              |        | R5                                     | 139                  | 153                   |                      | XPGBWT-HE-0000-00HF6 |                      |
|              |        | R4                                     | 130                  | 143                   |                      |                      |                      |
|              |        | R3                                     | 122                  | 134                   |                      |                      | XPGBWT-UE-0000-00FF6 |
|              |        | R2                                     | 114                  | 125                   |                      |                      | XPGBWT-UE-0000-00EF6 |
|              |        | Q5                                     | 107                  | 118                   |                      |                      | XPGBWT-UE-0000-00DF6 |
|              |        | Q4                                     | 100                  | 110                   |                      |                      | XPGBWT-UE-0000-00CF6 |
| E6           | 3500 K | S4                                     | 164                  | 180                   | XPGBWT-BE-0000-00LE6 |                      |                      |
|              |        | S3                                     | 156                  | 171                   | XPGBWT-BE-0000-00KE6 |                      |                      |
|              |        | S2                                     | 148                  | 163                   | XPGBWT-BE-0000-00JE6 | XPGBWT-HE-0000-00JE6 |                      |
|              |        | R5                                     | 139                  | 153                   |                      | XPGBWT-HE-0000-00HE6 |                      |
|              |        | R4                                     | 130                  | 143                   |                      |                      |                      |
|              |        | R3                                     | 122                  | 134                   |                      |                      | XPGBWT-UE-0000-00FE6 |
|              |        | R2                                     | 114                  | 125                   |                      |                      | XPGBWT-UE-0000-00EE6 |
|              |        | Q5                                     | 107                  | 118                   |                      |                      | XPGBWT-UE-0000-00DE6 |
|              |        | Q4                                     | 100                  | 110                   |                      |                      | XPGBWT-UE-0000-00CE6 |
| F7           | 3250 K | S3                                     | 156                  | 171                   | XPGBWT-BE-0000-00KF7 |                      |                      |
|              |        | S2                                     | 148                  | 163                   | XPGBWT-BE-0000-00JF7 |                      |                      |
|              |        | R5                                     | 139                  | 153                   | XPGBWT-BE-0000-00HF7 | XPGBWT-HE-0000-00HF7 |                      |
|              |        | R4                                     | 130                  | 143                   |                      | XPGBWT-HE-0000-00GF7 |                      |
|              |        | R3                                     | 122                  | 134                   |                      |                      | XPGBWT-UE-0000-00FF7 |
|              |        | R2                                     | 114                  | 125                   |                      |                      | XPGBWT-UE-0000-00EF7 |
|              |        | Q5                                     | 107                  | 118                   |                      |                      | XPGBWT-UE-0000-00DF7 |
|              |        | Q4                                     | 100                  | 110                   |                      |                      | XPGBWT-UE-0000-00CF7 |

**Notes**

- Cree maintains a tolerance of  $\pm 7\%$  on flux and power measurements,  $\pm 0.005$  on chromaticity (CCx, CCy) measurements and a tolerance of  $\pm 2$  on CRI measurements. See the Measurements section (page 33).
- Cree XLamp XP-G2 LED order codes specify only a minimum flux bin and not a maximum. Cree may ship reels in flux bins higher than the minimum specified by the order code without advance notice. Shipments will always adhere to the chromaticity bin restrictions specified by the order code.
- \* Flux values @ 25 °C are calculated and for reference only.

**FLUX CHARACTERISTICS - HIGH EFFICACY ( $T_j = 85\text{ }^\circ\text{C}$ ) - CONTINUED**

| Chromaticity |        | Minimum Luminous Flux (lm)<br>@ 350 mA |                      |                       | Order Codes          |                      |                      |
|--------------|--------|----------------------------------------|----------------------|-----------------------|----------------------|----------------------|----------------------|
| Kit          | CCT    | Code                                   | Flux (lm) @<br>85 °C | Flux (lm) @<br>25 °C* | 70 CRI Minimum       | 80 CRI Minimum       | 90 CRI Minimum       |
| E7           | 3000 K | S3                                     | 156                  | 171                   | XPGBWT-BE-0000-00KE7 |                      |                      |
|              |        | S2                                     | 148                  | 163                   | XPGBWT-BE-0000-00JE7 |                      |                      |
|              |        | R5                                     | 139                  | 153                   | XPGBWT-BE-0000-00HE7 | XPGBWT-HE-0000-00HE7 |                      |
|              |        | R4                                     | 130                  | 143                   |                      | XPGBWT-HE-0000-00GE7 |                      |
|              |        | R3                                     | 122                  | 134                   |                      |                      | XPGBWT-UE-0000-00FE7 |
|              |        | R2                                     | 114                  | 125                   |                      |                      | XPGBWT-UE-0000-00EE7 |
|              |        | Q5                                     | 107                  | 118                   |                      |                      | XPGBWT-UE-0000-00DE7 |
|              |        | Q4                                     | 100                  | 110                   |                      |                      | XPGBWT-UE-0000-00CE7 |
| F8           | 2850 K | S3                                     | 156                  | 171                   | XPGBWT-BE-0000-00KF8 |                      |                      |
|              |        | S2                                     | 148                  | 163                   | XPGBWT-BE-0000-00JF8 |                      |                      |
|              |        | R5                                     | 139                  | 153                   | XPGBWT-BE-0000-00HF8 | XPGBWT-HE-0000-00HF8 |                      |
|              |        | R4                                     | 130                  | 143                   |                      | XPGBWT-HE-0000-00GF8 |                      |
|              |        | R3                                     | 122                  | 134                   |                      |                      |                      |
|              |        | R2                                     | 114                  | 125                   |                      |                      | XPGBWT-UE-0000-00EF8 |
|              |        | Q5                                     | 107                  | 118                   |                      |                      | XPGBWT-UE-0000-00DF8 |
|              |        | Q4                                     | 100                  | 110                   |                      |                      | XPGBWT-UE-0000-00CF8 |
| E8           | 2700 K | S3                                     | 156                  | 171                   | XPGBWT-BE-0000-00KE8 |                      |                      |
|              |        | S2                                     | 148                  | 163                   | XPGBWT-BE-0000-00JE8 |                      |                      |
|              |        | R5                                     | 139                  | 153                   | XPGBWT-BE-0000-00HE8 | XPGBWT-HE-0000-00HE8 |                      |
|              |        | R4                                     | 130                  | 143                   |                      | XPGBWT-HE-0000-00GE8 |                      |
|              |        | R3                                     | 122                  | 134                   |                      |                      |                      |
|              |        | R2                                     | 114                  | 125                   |                      |                      | XPGBWT-UE-0000-00EE8 |
|              |        | Q5                                     | 107                  | 118                   |                      |                      | XPGBWT-UE-0000-00DE8 |
|              |        | Q4                                     | 100                  | 110                   |                      |                      | XPGBWT-UE-0000-00CE8 |

**Notes**

- Cree maintains a tolerance of  $\pm 7\%$  on flux and power measurements,  $\pm 0.005$  on chromaticity (CCx, CCy) measurements and a tolerance of  $\pm 2$  on CRI measurements. See the Measurements section (page 33).
- Cree XLamp XP-G2 LED order codes specify only a minimum flux bin and not a maximum. Cree may ship reels in flux bins higher than the minimum specified by the order code without advance notice. Shipments will always adhere to the chromaticity bin restrictions specified by the order code.
- \* Flux values @ 25 °C are calculated and for reference only.

## FLUX CHARACTERISTICS - STANDARD ( $T_j = 85\text{ °C}$ )

The following table provides order codes for XLamp Standard XP-G2 LEDs. For a complete description of the order code nomenclature, please see the Bin and Order Code Formats section (page 31). For definitions of the chromaticity kits, please see the Cree's Standard Chromaticity Kits section (page 30).

| Chromaticity |        | Minimum Luminous Flux (lm)<br>@ 350 mA |                      |                       | Order Codes          |
|--------------|--------|----------------------------------------|----------------------|-----------------------|----------------------|
| Kit          | CCT    | Code                                   | Flux (lm)<br>@ 85 °C | Flux (lm)<br>@ 25 °C* | 70 CRI Typical       |
| 51           | 6200 K | S4                                     | 164                  | 180                   | XPGBWT-L1-0000-00L51 |
|              |        | S3                                     | 156                  | 171                   | XPGBWT-L1-0000-00K51 |
|              |        | S2                                     | 148                  | 163                   | XPGBWT-L1-0000-00J51 |
|              |        | R5                                     | 139                  | 153                   | XPGBWT-L1-0000-00H51 |
|              |        | R4                                     | 130                  | 143                   | XPGBWT-L1-0000-00G51 |
|              |        | R3                                     | 122                  | 134                   | XPGBWT-L1-0000-00F51 |
| 53           | 6000 K | S4                                     | 164                  | 180                   | XPGBWT-L1-0000-00L53 |
|              |        | S3                                     | 156                  | 171                   | XPGBWT-L1-0000-00K53 |
|              |        | S2                                     | 148                  | 163                   | XPGBWT-L1-0000-00J53 |
|              |        | R5                                     | 139                  | 153                   | XPGBWT-L1-0000-00H53 |
|              |        | R4                                     | 130                  | 143                   | XPGBWT-L1-0000-00G53 |
|              |        | R3                                     | 122                  | 134                   | XPGBWT-L1-0000-00F53 |
| 50           | 6200 K | S4                                     | 164                  | 180                   | XPGBWT-L1-0000-00L50 |
|              |        | S3                                     | 156                  | 171                   | XPGBWT-L1-0000-00K50 |
|              |        | S2                                     | 148                  | 163                   | XPGBWT-L1-0000-00J50 |
|              |        | R5                                     | 139                  | 153                   | XPGBWT-L1-0000-00H50 |
|              |        | R4                                     | 130                  | 143                   | XPGBWT-L1-0000-00G50 |
|              |        | R3                                     | 122                  | 134                   | XPGBWT-L1-0000-00F50 |
| E1           | 6500 K | S4                                     | 164                  | 180                   | XPGBWT-L1-0000-00LE1 |
|              |        | S3                                     | 156                  | 171                   | XPGBWT-L1-0000-00KE1 |
|              |        | S2                                     | 148                  | 163                   | XPGBWT-L1-0000-00JE1 |
|              |        | R5                                     | 139                  | 153                   | XPGBWT-L1-0000-00HE1 |
|              |        | R4                                     | 130                  | 143                   | XPGBWT-L1-0000-00GE1 |
|              |        | R3                                     | 122                  | 134                   | XPGBWT-L1-0000-00FE1 |

### Notes

- Cree maintains a tolerance of  $\pm 7\%$  on flux and power measurements,  $\pm 0.005$  on chromaticity (CCx, CCy) measurements and a tolerance of  $\pm 2$  on CRI measurements. See the Measurements section (page 33).
- Cree XLamp XP-G2 LED order codes specify only a minimum flux bin and not a maximum. Cree may ship reels in flux bins higher than the minimum specified by the order code without advance notice. Shipments will always adhere to the chromaticity bin restrictions specified by the order code.
- \* Flux values @ 25 °C are calculated and for reference only.

**FLUX CHARACTERISTICS - STANDARD (T<sub>j</sub> = 85 °C) - CONTINUED**

| Chromaticity |        | Minimum Luminous Flux (lm)<br>@ 350 mA |                      |                       | Order Codes          |
|--------------|--------|----------------------------------------|----------------------|-----------------------|----------------------|
| Kit          | CCT    | Code                                   | Flux (lm)<br>@ 85 °C | Flux (lm)<br>@ 25 °C* | 70 CRI Typical       |
| E2           | 5700 K | S4                                     | 164                  | 180                   | XPGBWT-L1-0000-00LE2 |
|              |        | S3                                     | 156                  | 171                   | XPGBWT-L1-0000-00KE2 |
|              |        | S2                                     | 148                  | 163                   | XPGBWT-L1-0000-00JE2 |
|              |        | R5                                     | 139                  | 153                   | XPGBWT-L1-0000-00HE2 |
|              |        | R4                                     | 130                  | 143                   | XPGBWT-L1-0000-00GE2 |
|              |        | R3                                     | 122                  | 134                   | XPGBWT-L1-0000-00FE2 |

| Chromaticity |        | Minimum Luminous Flux (lm)<br>@ 350 mA |                      |                       | Order Codes          |                |
|--------------|--------|----------------------------------------|----------------------|-----------------------|----------------------|----------------|
| Kit          | CCT    | Code                                   | Flux (lm)<br>@ 85 °C | Flux (lm)<br>@ 25 °C* | 70 CRI Typical       | 80 CRI Minimum |
| E3           | 5000 K | S4                                     | 164                  | 180                   | XPGBWT-01-0000-00LE3 |                |
|              |        | S3                                     | 156                  | 171                   | XPGBWT-01-0000-00KE3 |                |
|              |        | S2                                     | 148                  | 163                   | XPGBWT-01-0000-00JE3 |                |
|              |        | R5                                     | 139                  | 153                   | XPGBWT-01-0000-00HE3 |                |
|              |        | R4                                     | 130                  | 143                   | XPGBWT-01-0000-00GE3 |                |
|              |        | R3                                     | 122                  | 134                   | XPGBWT-01-0000-00FE3 |                |
|              |        | R2                                     | 114                  | 125                   | XPGBWT-01-0000-00EE3 |                |
| F4           | 4750 K | S4                                     | 164                  | 180                   | XPGBWT-01-0000-00LF4 |                |
|              |        | S3                                     | 156                  | 171                   | XPGBWT-01-0000-00KF4 |                |
|              |        | S2                                     | 148                  | 163                   | XPGBWT-01-0000-00JF4 |                |
|              |        | R5                                     | 139                  | 153                   | XPGBWT-01-0000-00HF4 |                |
|              |        | R4                                     | 130                  | 143                   | XPGBWT-01-0000-00GF4 |                |
|              |        | R3                                     | 122                  | 134                   | XPGBWT-01-0000-00FF4 |                |
|              |        | R2                                     | 114                  | 125                   | XPGBWT-01-0000-00EF4 |                |

**Notes**

- Cree maintains a tolerance of ±7% on flux and power measurements, ±0.005 on chromaticity (CCx, CCy) measurements and a tolerance of ±2 on CRI measurements. See the Measurements section (page 33).
- Cree XLamp XP-G2 LED order codes specify only a minimum flux bin and not a maximum. Cree may ship reels in flux bins higher than the minimum specified by the order code without advance notice. Shipments will always adhere to the chromaticity bin restrictions specified by the order code.
- \* Flux values @ 25 °C are calculated and for reference only.

**FLUX CHARACTERISTICS - STANDARD (T<sub>j</sub> = 85 °C) - CONTINUED**

| Chromaticity |        | Minimum Luminous Flux (lm)<br>@ 350 mA |                      |                       | Order Codes          |                      |
|--------------|--------|----------------------------------------|----------------------|-----------------------|----------------------|----------------------|
| Kit          | CCT    | Code                                   | Flux (lm)<br>@ 85 °C | Flux (lm)<br>@ 25 °C* | 70 CRI Typical       | 80 CRI Minimum       |
| E4           | 4500 K | S4                                     | 164                  | 180                   | XPGBWT-01-0000-00LE4 |                      |
|              |        | S3                                     | 156                  | 171                   | XPGBWT-01-0000-00KE4 |                      |
|              |        | S2                                     | 148                  | 163                   | XPGBWT-01-0000-00JE4 |                      |
|              |        | R5                                     | 139                  | 153                   | XPGBWT-01-0000-00HE4 |                      |
|              |        | R4                                     | 130                  | 143                   | XPGBWT-01-0000-00GE4 |                      |
|              |        | R3                                     | 122                  | 134                   | XPGBWT-01-0000-00FE4 |                      |
|              |        | R2                                     | 114                  | 125                   | XPGBWT-01-0000-00EE4 |                      |
| F5           | 4250 K | S4                                     | 164                  | 180                   | XPGBWT-01-0000-00LF5 |                      |
|              |        | S3                                     | 156                  | 171                   | XPGBWT-01-0000-00KF5 |                      |
|              |        | S2                                     | 148                  | 163                   | XPGBWT-01-0000-00JF5 |                      |
|              |        | R5                                     | 139                  | 153                   | XPGBWT-01-0000-00HF5 |                      |
|              |        | R4                                     | 130                  | 143                   | XPGBWT-01-0000-00GF5 |                      |
|              |        | R3                                     | 122                  | 134                   | XPGBWT-01-0000-00FF5 |                      |
|              |        | R2                                     | 114                  | 125                   | XPGBWT-01-0000-00EF5 |                      |
| E5           | 4000 K | S4                                     | 164                  | 180                   | XPGBWT-01-0000-00LE5 |                      |
|              |        | S3                                     | 156                  | 171                   | XPGBWT-01-0000-00KE5 |                      |
|              |        | S2                                     | 148                  | 163                   | XPGBWT-01-0000-00JE5 |                      |
|              |        | R5                                     | 139                  | 153                   | XPGBWT-01-0000-00HE5 | XPGBWT-H1-0000-00HE5 |
|              |        | R4                                     | 130                  | 143                   | XPGBWT-01-0000-00GE5 | XPGBWT-H1-0000-00GE5 |
|              |        | R3                                     | 122                  | 134                   | XPGBWT-01-0000-00FE5 | XPGBWT-H1-0000-00FE5 |
|              |        | R2                                     | 114                  | 125                   | XPGBWT-01-0000-00EE5 | XPGBWT-H1-0000-00EE5 |
|              |        | Q5                                     | 107                  | 118                   |                      | XPGBWT-H1-0000-00DE5 |
| Z5           | 4000 K | R5                                     | 139                  | 153                   |                      | XPGBWT-H1-0000-00HZ5 |
|              |        | R4                                     | 130                  | 143                   |                      | XPGBWT-H1-0000-00GZ5 |
|              |        | R3                                     | 122                  | 134                   |                      | XPGBWT-H1-0000-00FZ5 |
|              |        | R2                                     | 114                  | 125                   |                      | XPGBWT-H1-0000-00EZ5 |
|              |        | Q5                                     | 107                  | 118                   |                      | XPGBWT-H1-0000-00DZ5 |

**Notes**

- Cree maintains a tolerance of ±7% on flux and power measurements, ±0.005 on chromaticity (CCx, CCy) measurements and a tolerance of ±2 on CRI measurements. See the Measurements section (page 33).
- Cree XLamp XP-G2 LED order codes specify only a minimum flux bin and not a maximum. Cree may ship reels in flux bins higher than the minimum specified by the order code without advance notice. Shipments will always adhere to the chromaticity bin restrictions specified by the order code.
- \* Flux values @ 25 °C are calculated and for reference only.

**FLUX CHARACTERISTICS - STANDARD (T<sub>j</sub> = 85 °C) - CONTINUED**

| Chromaticity |        | Minimum Luminous Flux (lm)<br>@ 350 mA |                      |                       | Order Codes          |                      |                      |                |
|--------------|--------|----------------------------------------|----------------------|-----------------------|----------------------|----------------------|----------------------|----------------|
| Kit          | CCT    | Code                                   | Flux (lm)<br>@ 85 °C | Flux (lm)<br>@ 25 °C* | 70 CRI Typical       | 80 CRI Typical       | 80 CRI Minimum       | 90 CRI Minimum |
| F6           | 3750 K | S2                                     | 148                  | 163                   | XPGBWT-01-0000-00JF6 |                      |                      |                |
|              |        | R5                                     | 139                  | 153                   | XPGBWT-01-0000-00HF6 | XPGBWT-L1-0000-00HF6 | XPGBWT-H1-0000-00HF6 |                |
|              |        | R4                                     | 130                  | 143                   | XPGBWT-01-0000-00GF6 | XPGBWT-L1-0000-00GF6 | XPGBWT-H1-0000-00GF6 |                |
|              |        | R3                                     | 122                  | 134                   | XPGBWT-01-0000-00FF6 | XPGBWT-L1-0000-00FF6 | XPGBWT-H1-0000-00FF6 |                |
|              |        | R2                                     | 114                  | 125                   | XPGBWT-01-0000-00EF6 | XPGBWT-L1-0000-00EF6 | XPGBWT-H1-0000-00EF6 |                |
|              |        | Q5                                     | 107                  | 118                   | XPGBWT-01-0000-00DF6 | XPGBWT-L1-0000-00DF6 | XPGBWT-H1-0000-00DF6 |                |
| E6           | 3500 K | S2                                     | 148                  | 163                   | XPGBWT-01-0000-00JE6 |                      |                      |                |
|              |        | R5                                     | 139                  | 153                   | XPGBWT-01-0000-00HE6 | XPGBWT-L1-0000-00HE6 | XPGBWT-H1-0000-00HE6 |                |
|              |        | R4                                     | 130                  | 143                   | XPGBWT-01-0000-00GE6 | XPGBWT-L1-0000-00GE6 | XPGBWT-H1-0000-00GE6 |                |
|              |        | R3                                     | 122                  | 134                   | XPGBWT-01-0000-00FE6 | XPGBWT-L1-0000-00FE6 | XPGBWT-H1-0000-00FE6 |                |
|              |        | R2                                     | 114                  | 125                   | XPGBWT-01-0000-00EE6 | XPGBWT-L1-0000-00EE6 | XPGBWT-H1-0000-00EE6 |                |
|              |        | Q5                                     | 107                  | 118                   | XPGBWT-01-0000-00DE6 | XPGBWT-L1-0000-00DE6 | XPGBWT-H1-0000-00DE6 |                |
| Z6           | 3500 K | R4                                     | 130                  | 143                   |                      | XPGBWT-L1-0000-00GZ6 | XPGBWT-H1-0000-00GZ6 |                |
|              |        | R3                                     | 122                  | 134                   |                      | XPGBWT-L1-0000-00FZ6 | XPGBWT-H1-0000-00FZ6 |                |
|              |        | R2                                     | 114                  | 125                   |                      | XPGBWT-L1-0000-00EZ6 | XPGBWT-H1-0000-00EZ6 |                |
|              |        | Q5                                     | 107                  | 118                   |                      | XPGBWT-L1-0000-00DZ6 | XPGBWT-H1-0000-00DZ6 |                |
| F7           | 3250 K | S2                                     | 148                  | 163                   | XPGBWT-01-0000-00JF7 |                      |                      |                |
|              |        | R5                                     | 139                  | 153                   | XPGBWT-01-0000-00HF7 | XPGBWT-L1-0000-00HF7 | XPGBWT-H1-0000-00HF7 |                |
|              |        | R4                                     | 130                  | 143                   | XPGBWT-01-0000-00GF7 | XPGBWT-L1-0000-00GF7 | XPGBWT-H1-0000-00GF7 |                |
|              |        | R3                                     | 122                  | 134                   | XPGBWT-01-0000-00FF7 | XPGBWT-L1-0000-00FF7 | XPGBWT-H1-0000-00FF7 |                |
|              |        | R2                                     | 114                  | 125                   | XPGBWT-01-0000-00EF7 | XPGBWT-L1-0000-00EF7 | XPGBWT-H1-0000-00EF7 |                |
|              |        | Q5                                     | 107                  | 118                   |                      | XPGBWT-L1-0000-00DF7 | XPGBWT-H1-0000-00DF7 |                |

**Notes**

- Cree maintains a tolerance of ±7% on flux and power measurements, ±0.005 on chromaticity (CCx, CCy) measurements and a tolerance of ±2 on CRI measurements. See the Measurements section (page 33).
- Cree XLamp XP-G2 LED order codes specify only a minimum flux bin and not a maximum. Cree may ship reels in flux bins higher than the minimum specified by the order code without advance notice. Shipments will always adhere to the chromaticity bin restrictions specified by the order code.
- \* Flux values @ 25 °C are calculated and for reference only.

**FLUX CHARACTERISTICS - STANDARD (T<sub>j</sub> = 85 °C) - CONTINUED**

| Chromaticity |        | Minimum Luminous Flux (lm)<br>@ 350 mA |                      |                       | Order Codes          |                      |                      |                      |  |
|--------------|--------|----------------------------------------|----------------------|-----------------------|----------------------|----------------------|----------------------|----------------------|--|
| Kit          | CCT    | Code                                   | Flux (lm)<br>@ 85 °C | Flux (lm)<br>@ 25 °C* | 70 CRI Typical       | 80 CRI Typical       | 80 CRI Minimum       | 90 CRI Minimum       |  |
| E7           | 3000 K | S2                                     | 148                  | 163                   | XPGBWT-01-0000-00JE7 |                      |                      |                      |  |
|              |        | R5                                     | 139                  | 153                   | XPGBWT-01-0000-00HE7 | XPGBWT-L1-0000-00HE7 | XPGBWT-H1-0000-00HE7 |                      |  |
|              |        | R4                                     | 130                  | 143                   | XPGBWT-01-0000-00GE7 | XPGBWT-L1-0000-00GE7 | XPGBWT-H1-0000-00GE7 |                      |  |
|              |        | R3                                     | 122                  | 134                   | XPGBWT-01-0000-00FE7 | XPGBWT-L1-0000-00FE7 | XPGBWT-H1-0000-00FE7 |                      |  |
|              |        | R2                                     | 114                  | 125                   | XPGBWT-01-0000-00EE7 | XPGBWT-L1-0000-00EE7 | XPGBWT-H1-0000-00EE7 | XPGBWT-U1-0000-00EE7 |  |
|              |        | Q5                                     | 107                  | 118                   |                      | XPGBWT-L1-0000-00DE7 | XPGBWT-H1-0000-00DE7 | XPGBWT-U1-0000-00DE7 |  |
|              |        | Q4                                     | 100                  | 110                   |                      | XPGBWT-L1-0000-00CE7 | XPGBWT-H1-0000-00CE7 | XPGBWT-U1-0000-00CE7 |  |
|              |        | Q3                                     | 93.9                 | 103                   |                      |                      |                      | XPGBWT-U1-0000-00BE7 |  |
|              |        | Q2                                     | 87.4                 | 96.1                  |                      |                      |                      | XPGBWT-U1-0000-00AE7 |  |
|              |        | P4                                     | 80.6                 | 88.6                  |                      |                      |                      | XPGBWT-U1-0000-009E7 |  |
|              |        | P3                                     | 73.9                 | 81.2                  |                      |                      |                      | XPGBWT-U1-0000-008E7 |  |
| Z7           | 3000 K | R4                                     | 130                  | 143                   |                      | XPGBWT-L1-0000-00GZ7 | XPGBWT-H1-0000-00GZ7 |                      |  |
|              |        | R3                                     | 122                  | 134                   |                      | XPGBWT-L1-0000-00FZ7 | XPGBWT-H1-0000-00FZ7 |                      |  |
|              |        | R2                                     | 114                  | 125                   |                      | XPGBWT-L1-0000-00EZ7 | XPGBWT-H1-0000-00EZ7 |                      |  |
|              |        | Q5                                     | 107                  | 118                   |                      | XPGBWT-L1-0000-00DZ7 | XPGBWT-H1-0000-00DZ7 | XPGBWT-U1-0000-00DZ7 |  |
|              |        | Q4                                     | 100                  | 110                   |                      | XPGBWT-L1-0000-00CZ7 | XPGBWT-H1-0000-00CZ7 | XPGBWT-U1-0000-00CZ7 |  |
|              |        | Q3                                     | 93.9                 | 103                   |                      |                      |                      | XPGBWT-U1-0000-00BZ7 |  |
|              |        | Q2                                     | 87.4                 | 96.1                  |                      |                      |                      | XPGBWT-U1-0000-00AZ7 |  |
|              |        | P4                                     | 80.6                 | 88.6                  |                      |                      |                      | XPGBWT-U1-0000-009Z7 |  |
|              |        | P3                                     | 73.9                 | 81.2                  |                      |                      |                      | XPGBWT-U1-0000-008Z7 |  |

**Notes**

- Cree maintains a tolerance of ±7% on flux and power measurements, ±0.005 on chromaticity (CCx, CCy) measurements and a tolerance of ±2 on CRI measurements. See the Measurements section (page 33).
- Cree XLamp XP-G2 LED order codes specify only a minimum flux bin and not a maximum. Cree may ship reels in flux bins higher than the minimum specified by the order code without advance notice. Shipments will always adhere to the chromaticity bin restrictions specified by the order code.
- \* Flux values @ 25 °C are calculated and for reference only.

**FLUX CHARACTERISTICS - STANDARD (T<sub>j</sub> = 85 °C) - CONTINUED**

| Chromaticity |        | Minimum Luminous Flux (lm)<br>@ 350 mA |                      |                       | Order Codes    |                      |                      |                      |
|--------------|--------|----------------------------------------|----------------------|-----------------------|----------------|----------------------|----------------------|----------------------|
| Kit          | CCT    | Code                                   | Flux (lm)<br>@ 85 °C | Flux (lm)<br>@ 25 °C* | 70 CRI Typical | 80 CRI Typical       | 80 CRI Minimum       | 90 CRI Minimum       |
| F8           | 2850 K | R4                                     | 130                  | 143                   |                | XPGBWT-L1-0000-00GF8 | XPGBWT-H1-0000-00GF8 |                      |
|              |        | R3                                     | 122                  | 134                   |                | XPGBWT-L1-0000-00FF8 | XPGBWT-H1-0000-00FF8 |                      |
|              |        | R2                                     | 114                  | 125                   |                | XPGBWT-L1-0000-00EF8 | XPGBWT-H1-0000-00EF8 |                      |
|              |        | Q5                                     | 107                  | 118                   |                | XPGBWT-L1-0000-00DF8 | XPGBWT-H1-0000-00DF8 | XPGBWT-U1-0000-00DF8 |
|              |        | Q4                                     | 100                  | 110                   |                | XPGBWT-L1-0000-00CF8 | XPGBWT-H1-0000-00CF8 | XPGBWT-U1-0000-00CF8 |
|              |        | Q3                                     | 93.9                 | 103                   |                | XPGBWT-L1-0000-00BF8 | XPGBWT-H1-0000-00BF8 | XPGBWT-U1-0000-00BF8 |
|              |        | Q2                                     | 87.4                 | 96.1                  |                |                      |                      | XPGBWT-U1-0000-00AF8 |
|              |        | P4                                     | 80.6                 | 88.6                  |                |                      |                      | XPGBWT-U1-0000-009F8 |
|              |        | P3                                     | 73.9                 | 81.2                  |                |                      |                      | XPGBWT-U1-0000-008F8 |
|              |        | P2                                     | 67.2                 | 73.9                  |                |                      |                      | XPGBWT-U1-0000-007F8 |
| E8           | 2700 K | R4                                     | 130                  | 143                   |                | XPGBWT-L1-0000-00GE8 | XPGBWT-H1-0000-00GE8 |                      |
|              |        | R3                                     | 122                  | 134                   |                | XPGBWT-L1-0000-00FE8 | XPGBWT-H1-0000-00FE8 |                      |
|              |        | R2                                     | 114                  | 125                   |                | XPGBWT-L1-0000-00EE8 | XPGBWT-H1-0000-00EE8 |                      |
|              |        | Q5                                     | 107                  | 118                   |                | XPGBWT-L1-0000-00DE8 | XPGBWT-H1-0000-00DE8 |                      |
|              |        | Q4                                     | 100                  | 110                   |                | XPGBWT-L1-0000-00CE8 | XPGBWT-H1-0000-00CE8 | XPGBWT-U1-0000-00CE8 |
|              |        | Q3                                     | 93.9                 | 103                   |                | XPGBWT-L1-0000-00BE8 | XPGBWT-H1-0000-00BE8 | XPGBWT-U1-0000-00BE8 |
|              |        | Q2                                     | 87.4                 | 96.1                  |                |                      |                      | XPGBWT-U1-0000-00AE8 |
|              |        | P4                                     | 80.6                 | 88.6                  |                |                      |                      | XPGBWT-U1-0000-009E8 |
|              |        | P3                                     | 73.9                 | 81.2                  |                |                      |                      | XPGBWT-U1-0000-008E8 |
|              |        | P2                                     | 67.2                 | 73.9                  |                |                      |                      | XPGBWT-U1-0000-007E8 |
| Z8           | 2700 K | R3                                     | 122                  | 134                   |                | XPGBWT-L1-0000-00FZ8 | XPGBWT-H1-0000-00FZ8 |                      |
|              |        | R2                                     | 114                  | 125                   |                | XPGBWT-L1-0000-00EZ8 | XPGBWT-H1-0000-00EZ8 |                      |
|              |        | Q5                                     | 107                  | 118                   |                | XPGBWT-L1-0000-00DZ8 | XPGBWT-H1-0000-00DZ8 |                      |
|              |        | Q4                                     | 100                  | 110                   |                | XPGBWT-L1-0000-00CZ8 | XPGBWT-H1-0000-00CZ8 |                      |
|              |        | Q3                                     | 93.9                 | 103                   |                | XPGBWT-L1-0000-00BZ8 | XPGBWT-H1-0000-00BZ8 | XPGBWT-U1-0000-00BZ8 |
|              |        | Q2                                     | 87.4                 | 96.1                  |                |                      |                      | XPGBWT-U1-0000-00AZ8 |
|              |        | P4                                     | 80.6                 | 88.6                  |                |                      |                      | XPGBWT-U1-0000-009Z8 |
|              |        | P3                                     | 73.9                 | 81.2                  |                |                      |                      | XPGBWT-U1-0000-008Z8 |
|              |        | P2                                     | 67.2                 | 73.9                  |                |                      |                      | XPGBWT-U1-0000-007Z8 |

**Notes**

- Cree maintains a tolerance of  $\pm 7\%$  on flux and power measurements,  $\pm 0.005$  on chromaticity (CCx, CCy) measurements and a tolerance of  $\pm 2$  on CRI measurements. See the Measurements section (page 33).
- Cree XLamp XP-G2 LED order codes specify only a minimum flux bin and not a maximum. Cree may ship reels in flux bins higher than the minimum specified by the order code without advance notice. Shipments will always adhere to the chromaticity bin restrictions specified by the order code.
- \* Flux values @ 25 °C are calculated and for reference only.

**RELATIVE SPECTRAL POWER DISTRIBUTION**

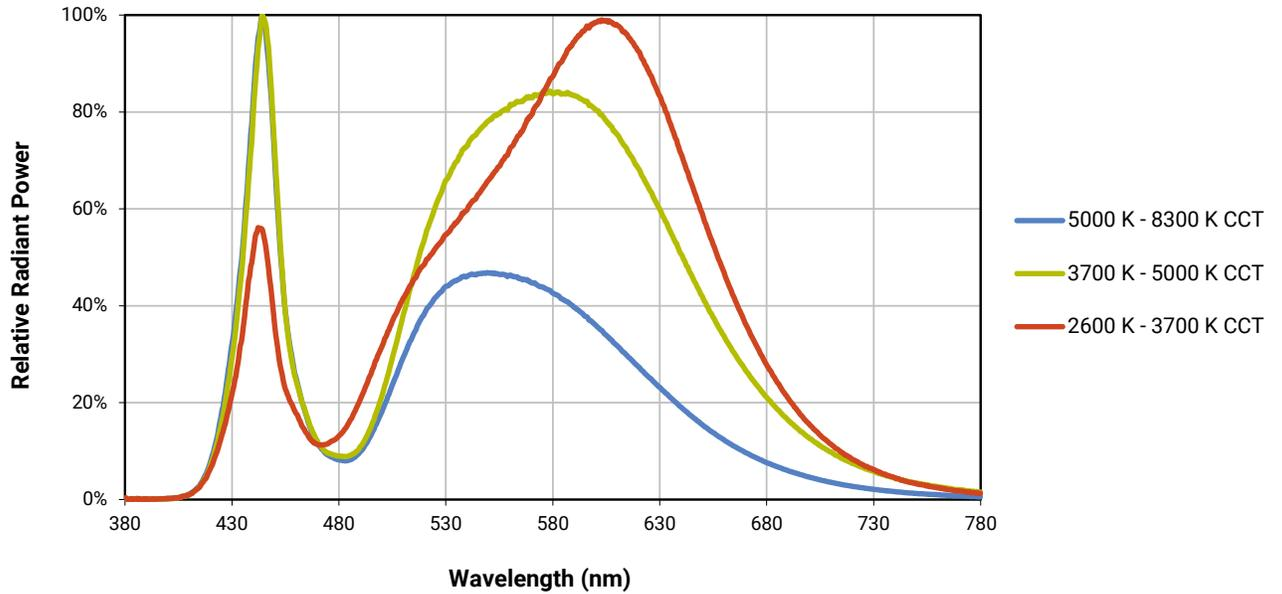

**RELATIVE FLUX VS. JUNCTION TEMPERATURE ( $I_F = 350$  mA)**

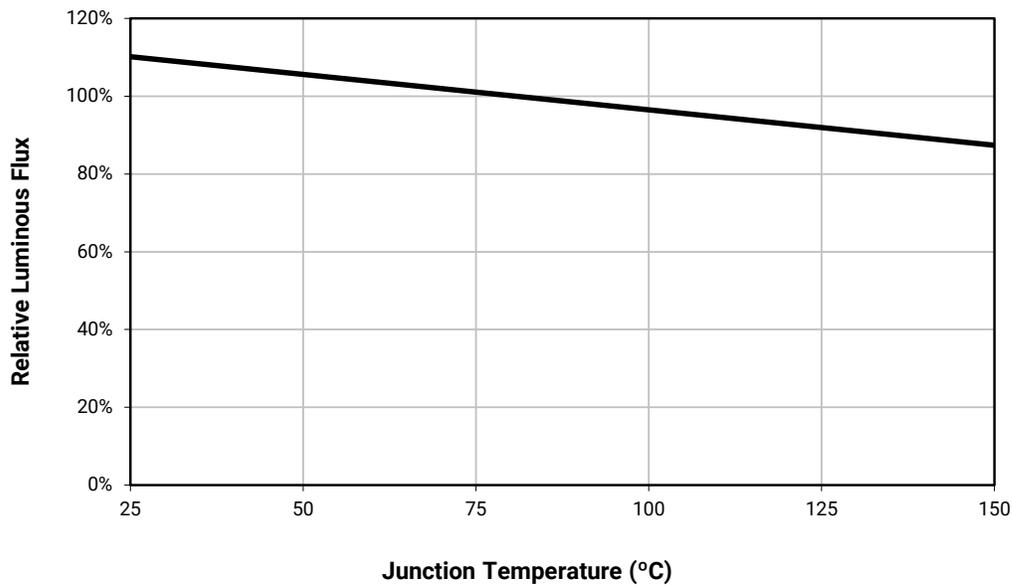

**ELECTRICAL CHARACTERISTICS - HIGH EFFICACY ( $T_j = 85\text{ }^\circ\text{C}$ )**

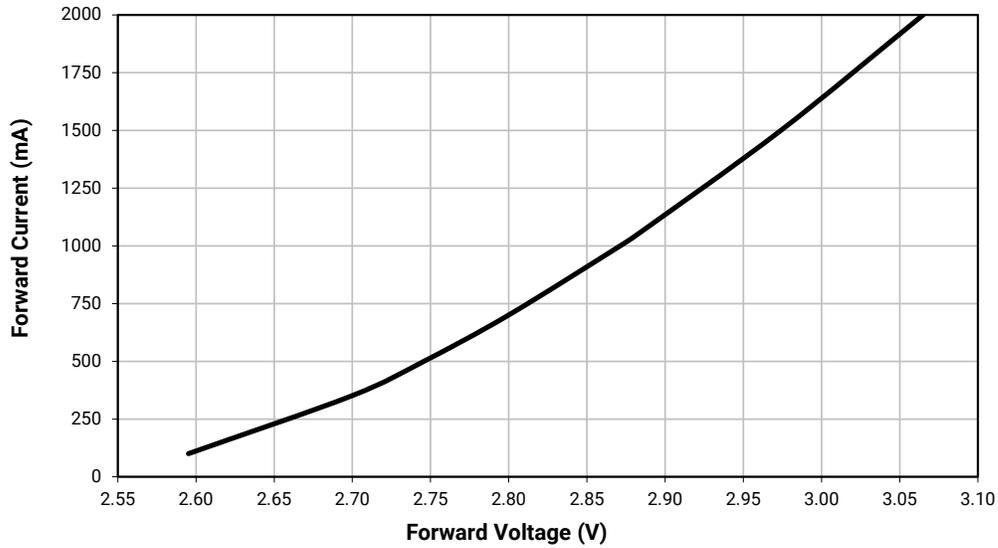

**ELECTRICAL CHARACTERISTICS - STANDARD ( $T_j = 85\text{ }^\circ\text{C}$ )**

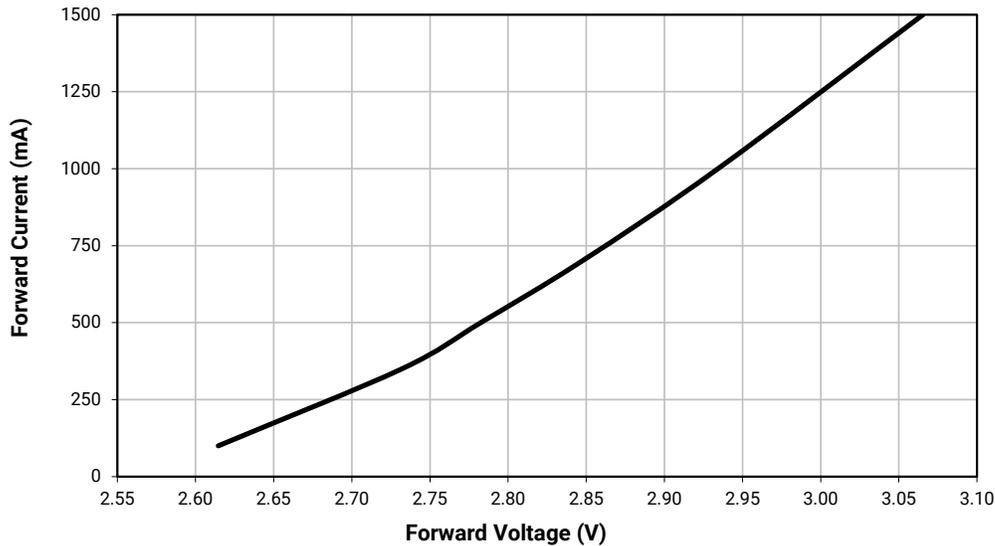

**RELATIVE FLUX VS. CURRENT - HIGH EFFICACY ( $T_j = 85\text{ }^\circ\text{C}$ )**

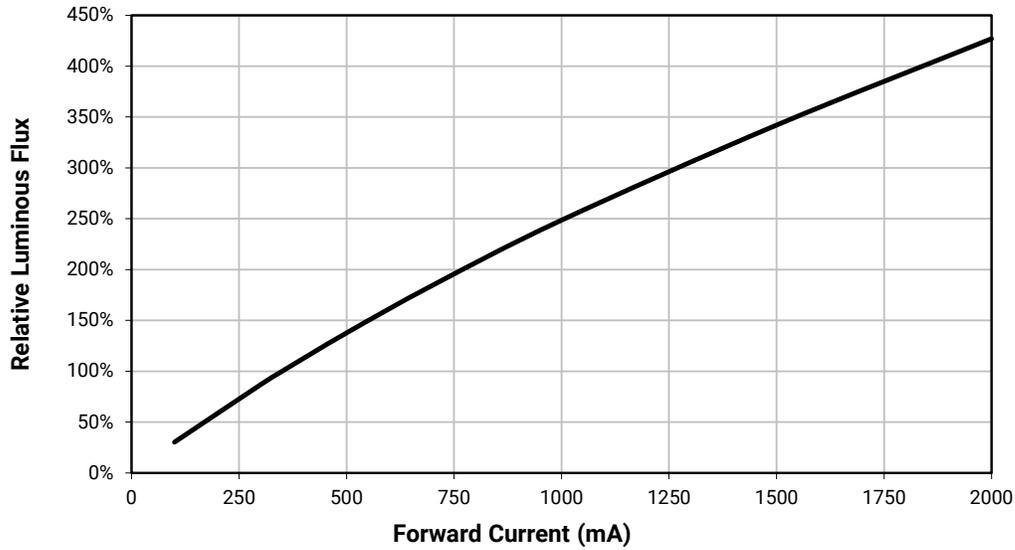

**RELATIVE FLUX VS. CURRENT - STANDARD ( $T_j = 85\text{ }^\circ\text{C}$ )**

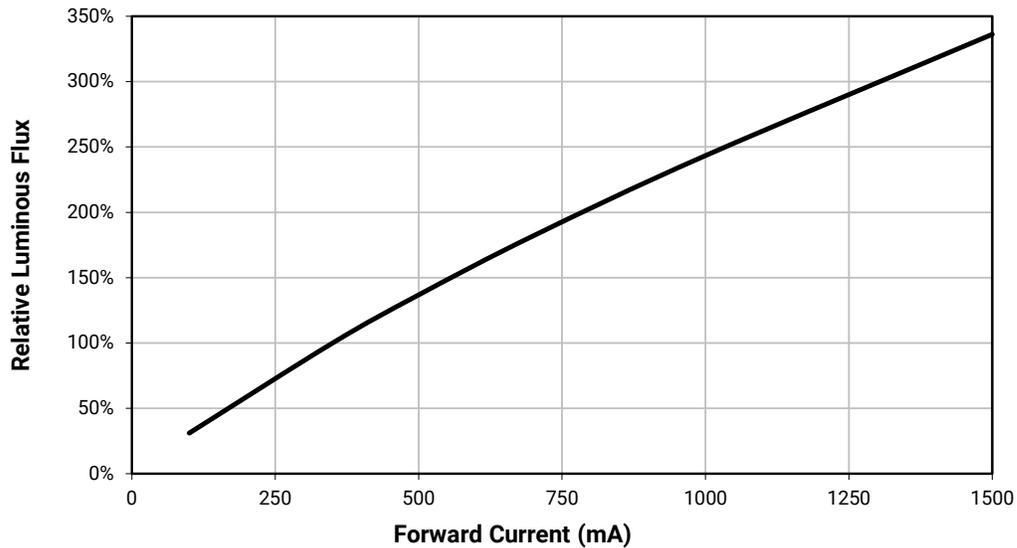

**RELATIVE CHROMATICITY VS CURRENT AND TEMPERATURE - HIGH EFFICACY (WARM WHITE)**

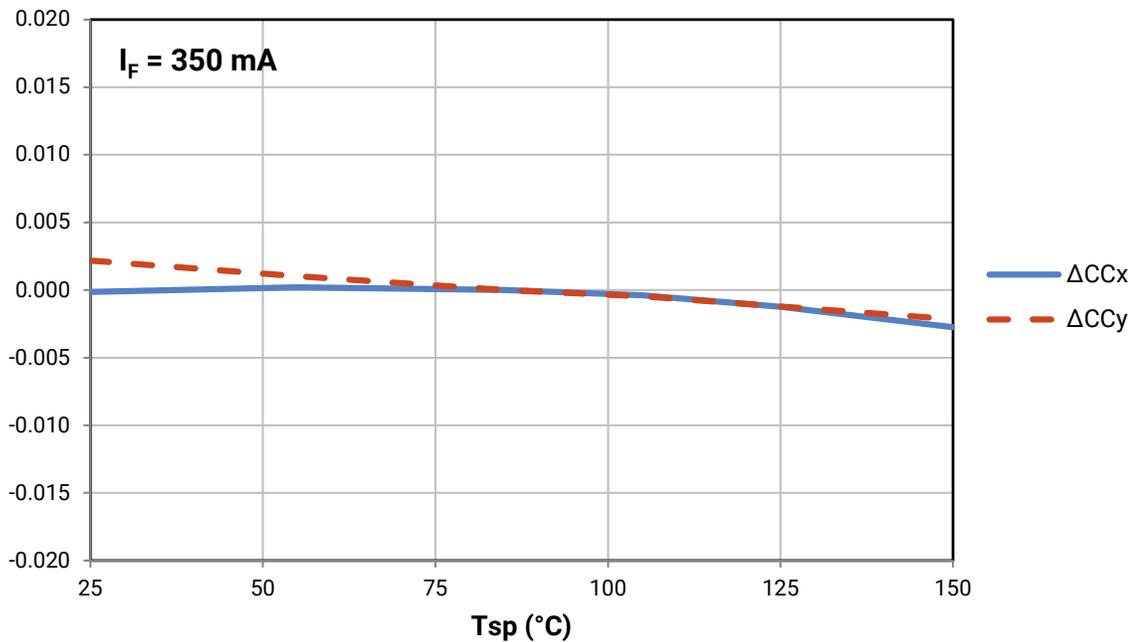
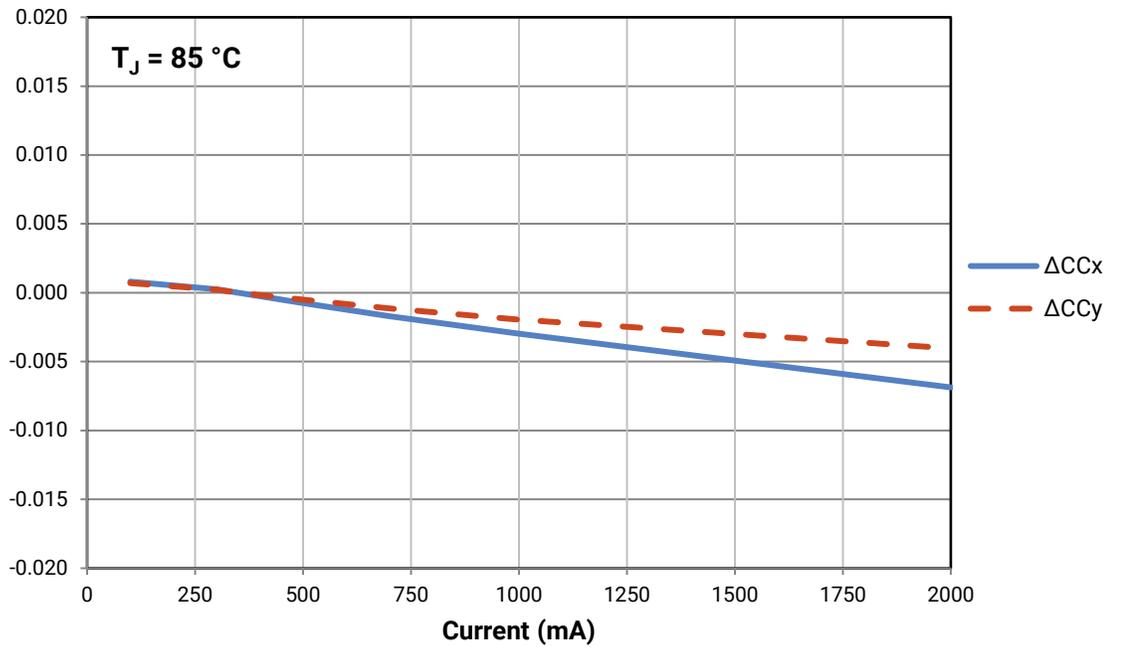

**RELATIVE CHROMATICITY VS CURRENT AND TEMPERATURE - STANDARD (WARM WHITE\*)**

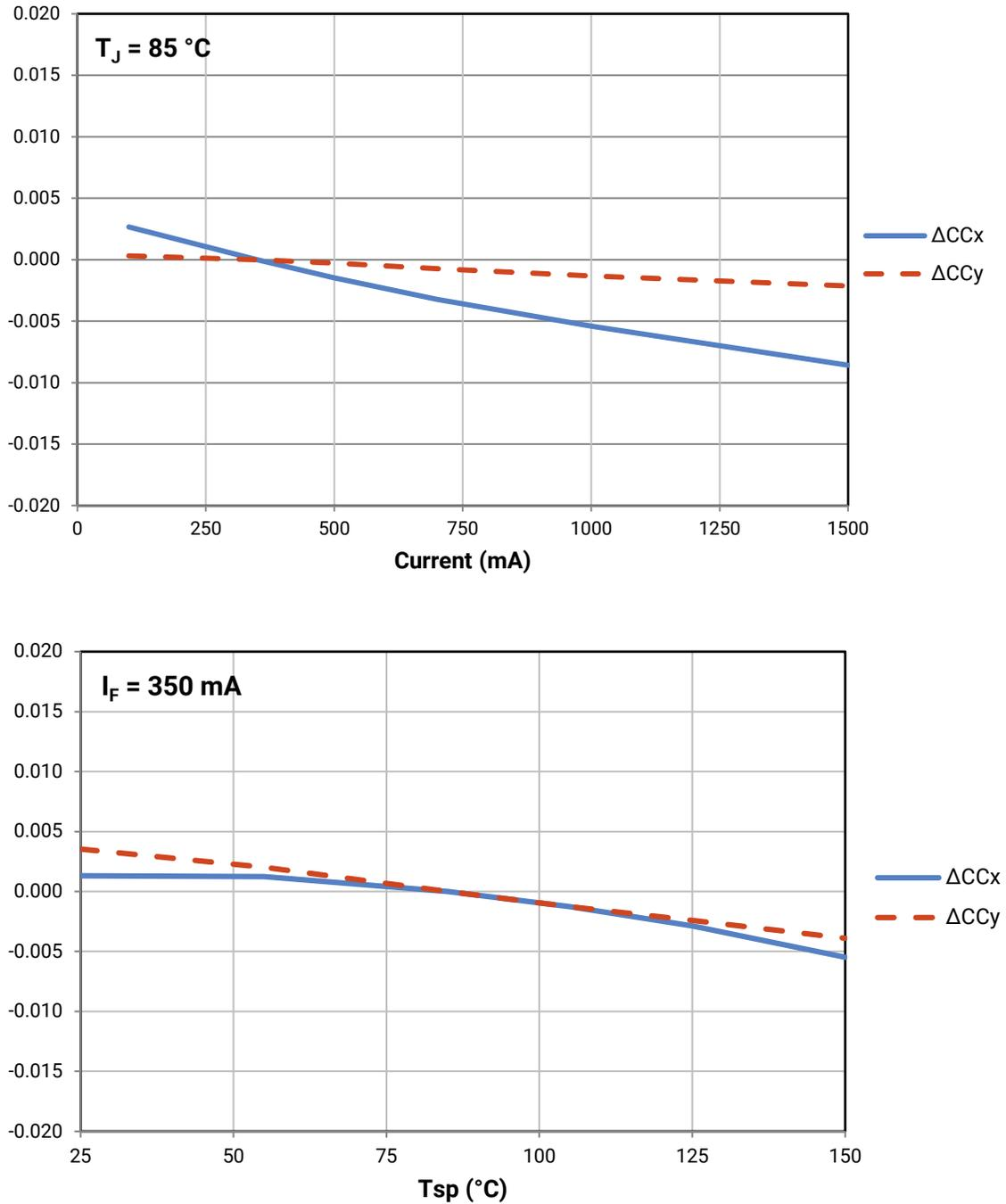

\* Warm White XLamp XP-G2 LEDs have a typical CRI of 80.

**TYPICAL SPATIAL DISTRIBUTION - HIGH EFFICACY**

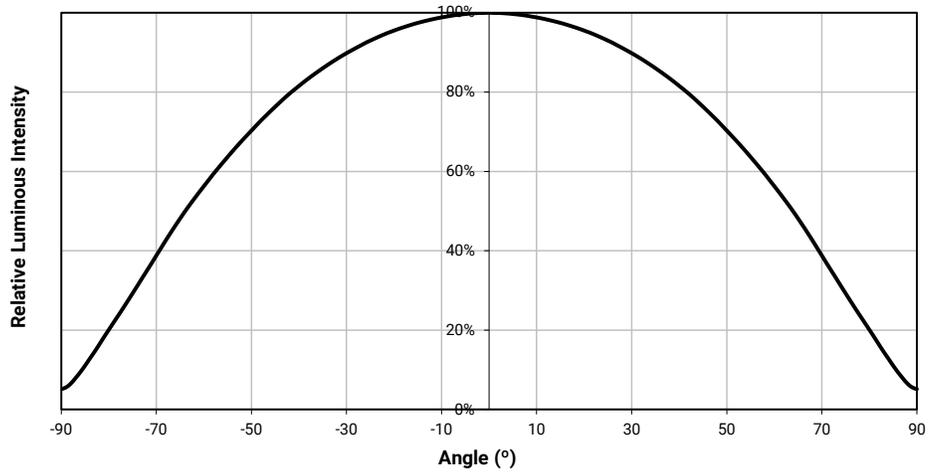

**TYPICAL SPATIAL DISTRIBUTION - STANDARD**

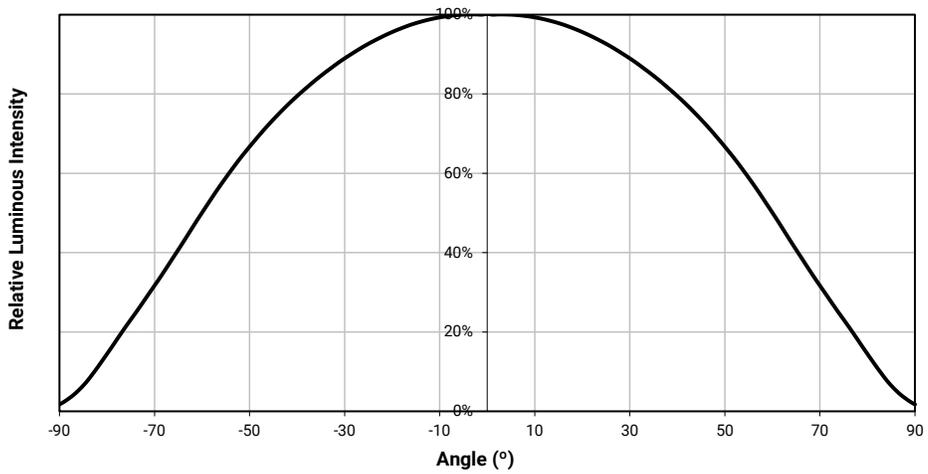

**THERMAL DESIGN - HIGH EFFICACY**

The maximum forward current is determined by the thermal resistance between the LED junction and ambient. It is crucial for the end product to be designed in a manner that minimizes the thermal resistance from the solder point to ambient in order to optimize lamp life and optical characteristics.

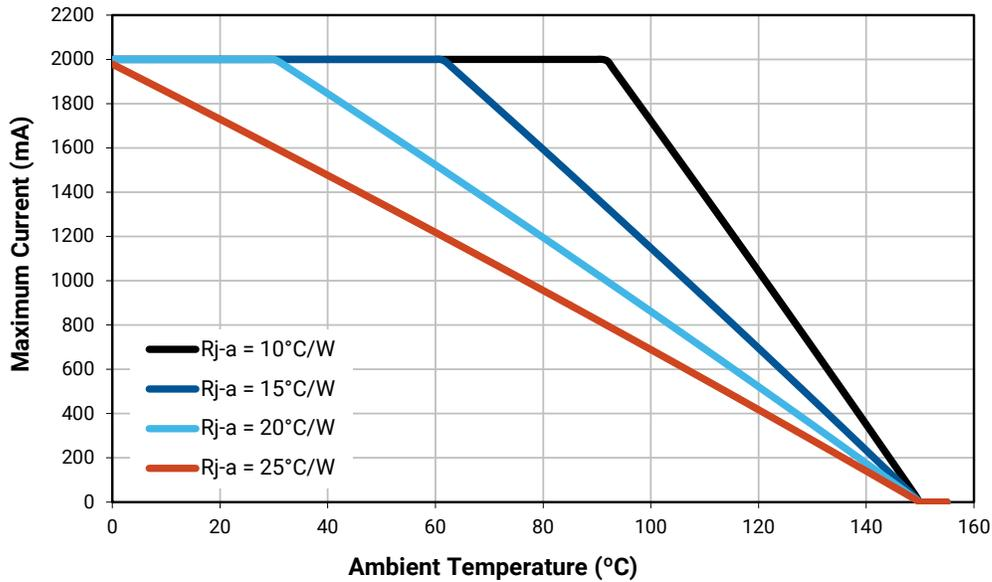

**THERMAL DESIGN - STANDARD**

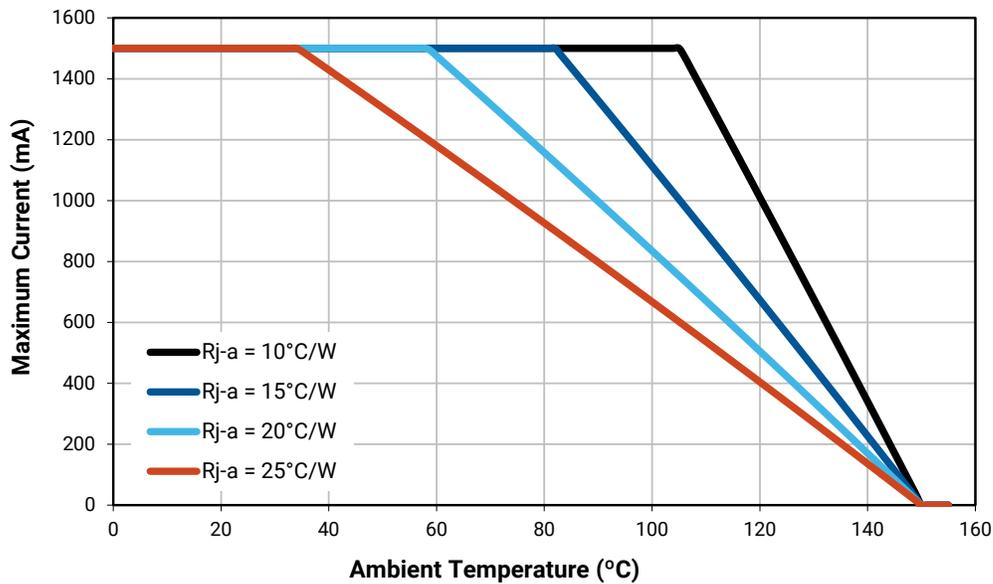

**PERFORMANCE GROUPS – LUMINOUS FLUX**

XLamp XP-G2 LEDs are tested for luminous flux and placed into one of the following luminous-flux groups:

| Group Code | Minimum Luminous Flux (lm) @ 350 mA | Maximum Luminous Flux (lm) @ 350 mA |
|------------|-------------------------------------|-------------------------------------|
| P2         | 67.2                                | 73.9                                |
| P3         | 73.9                                | 80.6                                |
| P4         | 80.6                                | 87.4                                |
| Q2         | 87.4                                | 93.9                                |
| Q3         | 93.9                                | 100                                 |
| Q4         | 100                                 | 107                                 |
| Q5         | 107                                 | 114                                 |
| R2         | 114                                 | 122                                 |
| R3         | 122                                 | 130                                 |
| R4         | 130                                 | 139                                 |
| R5         | 139                                 | 148                                 |
| S2         | 148                                 | 156                                 |
| S3         | 156                                 | 164                                 |
| S4         | 164                                 | 172                                 |
| S5         | 172                                 | 180                                 |

**PERFORMANCE GROUPS – CHROMATICITY**

| Region | x      | y      | Region | x      | y      | Region | x      | y      | Region | x      | y      |
|--------|--------|--------|--------|--------|--------|--------|--------|--------|--------|--------|--------|
| 0A     | 0.2950 | 0.2970 | 0B     | 0.2920 | 0.3060 | 0C     | 0.2984 | 0.3133 | 0D     | 0.2984 | 0.3133 |
|        | 0.2920 | 0.3060 |        | 0.2895 | 0.3135 |        | 0.2962 | 0.3220 |        | 0.3048 | 0.3207 |
|        | 0.2984 | 0.3133 |        | 0.2962 | 0.3220 |        | 0.3028 | 0.3304 |        | 0.3068 | 0.3113 |
|        | 0.3009 | 0.3042 |        | 0.2984 | 0.3133 |        | 0.3048 | 0.3207 |        | 0.3009 | 0.3042 |
| 0R     | 0.2980 | 0.2880 | 0S     | 0.2895 | 0.3135 | 0T     | 0.2962 | 0.3220 | 0U     | 0.3037 | 0.2937 |
|        | 0.2950 | 0.2970 |        | 0.2870 | 0.3210 |        | 0.2937 | 0.3312 |        | 0.3009 | 0.3042 |
|        | 0.3009 | 0.3042 |        | 0.2937 | 0.3312 |        | 0.3005 | 0.3415 |        | 0.3068 | 0.3113 |
|        | 0.3037 | 0.2937 |        | 0.2962 | 0.3220 |        | 0.3028 | 0.3304 |        | 0.3093 | 0.2993 |
| 1A     | 0.3048 | 0.3207 | 1B     | 0.3028 | 0.3304 | 1C     | 0.3115 | 0.3391 | 1D     | 0.3130 | 0.3290 |
|        | 0.3130 | 0.3290 |        | 0.3115 | 0.3391 |        | 0.3205 | 0.3481 |        | 0.3213 | 0.3373 |
|        | 0.3144 | 0.3186 |        | 0.3130 | 0.3290 |        | 0.3213 | 0.3373 |        | 0.3221 | 0.3261 |
|        | 0.3068 | 0.3113 |        | 0.3048 | 0.3207 |        | 0.3130 | 0.3290 |        | 0.3144 | 0.3186 |
| 1R     | 0.3068 | 0.3113 | 1S     | 0.3005 | 0.3415 | 1T     | 0.3099 | 0.3509 | 1U     | 0.3144 | 0.3186 |
|        | 0.3144 | 0.3186 |        | 0.3099 | 0.3509 |        | 0.3196 | 0.3602 |        | 0.3221 | 0.3261 |
|        | 0.3161 | 0.3059 |        | 0.3115 | 0.3391 |        | 0.3205 | 0.3481 |        | 0.3231 | 0.3120 |
|        | 0.3093 | 0.2993 |        | 0.3028 | 0.3304 |        | 0.3115 | 0.3391 |        | 0.3161 | 0.3059 |
| 2A     | 0.3215 | 0.3350 | 2B     | 0.3207 | 0.3462 | 2C     | 0.3290 | 0.3538 | 2D     | 0.3290 | 0.3417 |
|        | 0.3290 | 0.3417 |        | 0.3290 | 0.3538 |        | 0.3376 | 0.3616 |        | 0.3371 | 0.3490 |
|        | 0.3290 | 0.3300 |        | 0.3290 | 0.3417 |        | 0.3371 | 0.3490 |        | 0.3366 | 0.3369 |
|        | 0.3222 | 0.3243 |        | 0.3215 | 0.3350 |        | 0.3290 | 0.3417 |        | 0.3290 | 0.3300 |
| 2R     | 0.3222 | 0.3243 | 2S     | 0.3196 | 0.3602 | 2T     | 0.3290 | 0.3690 | 2U     | 0.3290 | 0.3300 |
|        | 0.3290 | 0.3300 |        | 0.3290 | 0.3690 |        | 0.3381 | 0.3762 |        | 0.3366 | 0.3369 |
|        | 0.3290 | 0.3180 |        | 0.3290 | 0.3538 |        | 0.3376 | 0.3616 |        | 0.3361 | 0.3245 |
|        | 0.3231 | 0.3120 |        | 0.3207 | 0.3462 |        | 0.3290 | 0.3538 |        | 0.3290 | 0.3180 |
| 3A     | 0.3371 | 0.3490 | 3B     | 0.3376 | 0.3616 | 3C     | 0.3463 | 0.3687 | 3D     | 0.3451 | 0.3554 |
|        | 0.3451 | 0.3554 |        | 0.3463 | 0.3687 |        | 0.3551 | 0.3760 |        | 0.3533 | 0.3620 |
|        | 0.3440 | 0.3427 |        | 0.3451 | 0.3554 |        | 0.3533 | 0.3620 |        | 0.3515 | 0.3487 |
|        | 0.3366 | 0.3369 |        | 0.3371 | 0.3490 |        | 0.3451 | 0.3554 |        | 0.3440 | 0.3427 |
| 3R     | 0.3366 | 0.3369 | 3S     | 0.3381 | 0.3762 |        |        |        |        |        |        |
|        | 0.3440 | 0.3428 |        | 0.3480 | 0.3840 |        |        |        |        |        |        |
|        | 0.3429 | 0.3307 |        | 0.3463 | 0.3687 |        |        |        |        |        |        |
|        | 0.3361 | 0.3245 |        | 0.3376 | 0.3616 |        |        |        |        |        |        |
| 4A     | 0.3530 | 0.3597 | 4B     | 0.3548 | 0.3736 | 4C     | 0.3641 | 0.3804 | 4D     | 0.3615 | 0.3659 |
|        | 0.3615 | 0.3659 |        | 0.3641 | 0.3804 |        | 0.3736 | 0.3874 |        | 0.3702 | 0.3722 |
|        | 0.3590 | 0.3521 |        | 0.3615 | 0.3659 |        | 0.3702 | 0.3722 |        | 0.3670 | 0.3578 |
|        | 0.3512 | 0.3465 |        | 0.3530 | 0.3597 |        | 0.3615 | 0.3659 |        | 0.3590 | 0.3521 |

**PERFORMANCE GROUPS – CHROMATICITY (CONTINUED)**

| Region | x      | y      | Region | x      | y      | Region | x      | y      | Region | x      | y      |
|--------|--------|--------|--------|--------|--------|--------|--------|--------|--------|--------|--------|
| 5A1    | 0.3670 | 0.3578 | 5A2    | 0.3686 | 0.3649 | 5A3    | 0.3744 | 0.3685 | 5A4    | 0.3726 | 0.3612 |
|        | 0.3686 | 0.3649 |        | 0.3702 | 0.3722 |        | 0.3763 | 0.3760 |        | 0.3744 | 0.3685 |
|        | 0.3744 | 0.3685 |        | 0.3763 | 0.3760 |        | 0.3825 | 0.3798 |        | 0.3804 | 0.3721 |
|        | 0.3726 | 0.3612 |        | 0.3744 | 0.3685 |        | 0.3804 | 0.3721 |        | 0.3783 | 0.3646 |
| 5B1    | 0.3702 | 0.3722 | 5B2    | 0.3719 | 0.3797 | 5B3    | 0.3782 | 0.3837 | 5B4    | 0.3763 | 0.3760 |
|        | 0.3719 | 0.3797 |        | 0.3736 | 0.3874 |        | 0.3802 | 0.3916 |        | 0.3782 | 0.3837 |
|        | 0.3782 | 0.3837 |        | 0.3802 | 0.3916 |        | 0.3869 | 0.3958 |        | 0.3847 | 0.3877 |
|        | 0.3763 | 0.3760 |        | 0.3782 | 0.3837 |        | 0.3847 | 0.3877 |        | 0.3825 | 0.3798 |
| 5C1    | 0.3825 | 0.3798 | 5C2    | 0.3847 | 0.3877 | 5C3    | 0.3912 | 0.3917 | 5C4    | 0.3887 | 0.3836 |
|        | 0.3847 | 0.3877 |        | 0.3869 | 0.3958 |        | 0.3937 | 0.4001 |        | 0.3912 | 0.3917 |
|        | 0.3912 | 0.3917 |        | 0.3937 | 0.4001 |        | 0.4006 | 0.4044 |        | 0.3978 | 0.3958 |
|        | 0.3887 | 0.3836 |        | 0.3912 | 0.3917 |        | 0.3978 | 0.3958 |        | 0.3950 | 0.3875 |
| 5D1    | 0.3783 | 0.3646 | 5D2    | 0.3804 | 0.3721 | 5D3    | 0.3863 | 0.3758 | 5D4    | 0.3840 | 0.3681 |
|        | 0.3804 | 0.3721 |        | 0.3825 | 0.3798 |        | 0.3887 | 0.3836 |        | 0.3863 | 0.3758 |
|        | 0.3863 | 0.3758 |        | 0.3887 | 0.3836 |        | 0.3950 | 0.3875 |        | 0.3924 | 0.3794 |
|        | 0.3840 | 0.3681 |        | 0.3863 | 0.3758 |        | 0.3924 | 0.3794 |        | 0.3898 | 0.3716 |
| 6A1    | 0.3889 | 0.3690 | 6A2    | 0.3915 | 0.3768 | 6A3    | 0.3981 | 0.3800 | 6A4    | 0.3953 | 0.3720 |
|        | 0.3915 | 0.3768 |        | 0.3941 | 0.3848 |        | 0.4010 | 0.3882 |        | 0.3981 | 0.3800 |
|        | 0.3981 | 0.3800 |        | 0.4010 | 0.3882 |        | 0.4080 | 0.3916 |        | 0.4048 | 0.3832 |
|        | 0.3953 | 0.3720 |        | 0.3981 | 0.3800 |        | 0.4048 | 0.3832 |        | 0.4017 | 0.3751 |
| 6B1    | 0.3941 | 0.3848 | 6B2    | 0.3968 | 0.3930 | 6B3    | 0.4040 | 0.3966 | 6B4    | 0.4010 | 0.3882 |
|        | 0.3968 | 0.3930 |        | 0.3996 | 0.4015 |        | 0.4071 | 0.4052 |        | 0.4040 | 0.3966 |
|        | 0.4040 | 0.3966 |        | 0.4071 | 0.4052 |        | 0.4146 | 0.4089 |        | 0.4113 | 0.4001 |
|        | 0.4010 | 0.3882 |        | 0.4040 | 0.3966 |        | 0.4113 | 0.4001 |        | 0.4080 | 0.3916 |
| 6C1    | 0.4080 | 0.3916 | 6C2    | 0.4113 | 0.4001 | 6C3    | 0.4186 | 0.4037 | 6C4    | 0.4150 | 0.3950 |
|        | 0.4113 | 0.4001 |        | 0.4146 | 0.4089 |        | 0.4222 | 0.4127 |        | 0.4186 | 0.4037 |
|        | 0.4186 | 0.4037 |        | 0.4222 | 0.4127 |        | 0.4299 | 0.4165 |        | 0.4259 | 0.4073 |
|        | 0.4150 | 0.3950 |        | 0.4186 | 0.4037 |        | 0.4259 | 0.4073 |        | 0.4221 | 0.3984 |
| 6D1    | 0.4017 | 0.3751 | 6D2    | 0.4048 | 0.3832 | 6D3    | 0.4116 | 0.3865 | 6D4    | 0.4082 | 0.3782 |
|        | 0.4048 | 0.3832 |        | 0.4080 | 0.3916 |        | 0.4150 | 0.3950 |        | 0.4116 | 0.3865 |
|        | 0.4116 | 0.3865 |        | 0.4150 | 0.3950 |        | 0.4221 | 0.3984 |        | 0.4183 | 0.3898 |
|        | 0.4082 | 0.3782 |        | 0.4116 | 0.3865 |        | 0.4183 | 0.3898 |        | 0.4147 | 0.3814 |
| 7A1    | 0.4147 | 0.3814 | 7A2    | 0.4183 | 0.3898 | 7A3    | 0.4242 | 0.3919 | 7A4    | 0.4203 | 0.3833 |
|        | 0.4183 | 0.3898 |        | 0.4221 | 0.3984 |        | 0.4281 | 0.4006 |        | 0.4242 | 0.3919 |
|        | 0.4242 | 0.3919 |        | 0.4281 | 0.4006 |        | 0.4342 | 0.4028 |        | 0.4300 | 0.3939 |
|        | 0.4203 | 0.3833 |        | 0.4242 | 0.3919 |        | 0.4300 | 0.3939 |        | 0.4259 | 0.3853 |

**PERFORMANCE GROUPS – CHROMATICITY (CONTINUED)**

| Region | x      | y      | Region | x      | y      | Region | x      | y      | Region | x      | y      |
|--------|--------|--------|--------|--------|--------|--------|--------|--------|--------|--------|--------|
| 7B1    | 0.4221 | 0.3984 | 7B2    | 0.4259 | 0.4073 | 7B3    | 0.4322 | 0.4096 | 7B4    | 0.4281 | 0.4006 |
|        | 0.4259 | 0.4073 |        | 0.4299 | 0.4165 |        | 0.4364 | 0.4188 |        | 0.4322 | 0.4096 |
|        | 0.4322 | 0.4096 |        | 0.4364 | 0.4188 |        | 0.4430 | 0.4212 |        | 0.4385 | 0.4119 |
|        | 0.4281 | 0.4006 |        | 0.4322 | 0.4096 |        | 0.4385 | 0.4119 |        | 0.4342 | 0.4028 |
| 7C1    | 0.4342 | 0.4028 | 7C2    | 0.4385 | 0.4119 | 7C3    | 0.4449 | 0.4141 | 7C4    | 0.4403 | 0.4049 |
|        | 0.4385 | 0.4119 |        | 0.4430 | 0.4212 |        | 0.4496 | 0.4236 |        | 0.4449 | 0.4141 |
|        | 0.4449 | 0.4141 |        | 0.4496 | 0.4236 |        | 0.4562 | 0.4260 |        | 0.4513 | 0.4164 |
|        | 0.4403 | 0.4049 |        | 0.4449 | 0.4141 |        | 0.4513 | 0.4164 |        | 0.4465 | 0.4071 |
| 7D1    | 0.4259 | 0.3853 | 7D2    | 0.4300 | 0.3939 | 7D3    | 0.4359 | 0.3960 | 7D4    | 0.4316 | 0.3873 |
|        | 0.4300 | 0.3939 |        | 0.4342 | 0.4028 |        | 0.4403 | 0.4049 |        | 0.4359 | 0.3960 |
|        | 0.4359 | 0.3960 |        | 0.4403 | 0.4049 |        | 0.4465 | 0.4071 |        | 0.4418 | 0.3981 |
|        | 0.4316 | 0.3873 |        | 0.4359 | 0.3960 |        | 0.4418 | 0.3981 |        | 0.4373 | 0.3893 |
| 8A1    | 0.4373 | 0.3893 | 8A2    | 0.4418 | 0.3981 | 8A3    | 0.4475 | 0.3994 | 8A4    | 0.4428 | 0.3906 |
|        | 0.4418 | 0.3981 |        | 0.4465 | 0.4071 |        | 0.4523 | 0.4085 |        | 0.4475 | 0.3994 |
|        | 0.4475 | 0.3994 |        | 0.4523 | 0.4085 |        | 0.4582 | 0.4099 |        | 0.4532 | 0.4008 |
|        | 0.4428 | 0.3906 |        | 0.4475 | 0.3994 |        | 0.4532 | 0.4008 |        | 0.4483 | 0.3919 |
| 8B1    | 0.4465 | 0.4071 | 8B2    | 0.4513 | 0.4164 | 8B3    | 0.4573 | 0.4178 | 8B4    | 0.4523 | 0.4085 |
|        | 0.4513 | 0.4164 |        | 0.4562 | 0.4260 |        | 0.4624 | 0.4274 |        | 0.4573 | 0.4178 |
|        | 0.4573 | 0.4178 |        | 0.4624 | 0.4274 |        | 0.4687 | 0.4289 |        | 0.4634 | 0.4193 |
|        | 0.4523 | 0.4085 |        | 0.4573 | 0.4178 |        | 0.4634 | 0.4193 |        | 0.4582 | 0.4099 |
| 8C1    | 0.4582 | 0.4099 | 8C2    | 0.4634 | 0.4193 | 8C3    | 0.4695 | 0.4207 | 8C4    | 0.4641 | 0.4112 |
|        | 0.4634 | 0.4193 |        | 0.4687 | 0.4289 |        | 0.4750 | 0.4304 |        | 0.4695 | 0.4207 |
|        | 0.4695 | 0.4207 |        | 0.4750 | 0.4304 |        | 0.4813 | 0.4319 |        | 0.4756 | 0.4221 |
|        | 0.4641 | 0.4112 |        | 0.4695 | 0.4207 |        | 0.4756 | 0.4221 |        | 0.4700 | 0.4126 |
| 8D1    | 0.4483 | 0.3919 | 8D2    | 0.4532 | 0.4008 | 8D3    | 0.4589 | 0.4021 | 8D4    | 0.4538 | 0.3931 |
|        | 0.4532 | 0.4008 |        | 0.4582 | 0.4099 |        | 0.4641 | 0.4112 |        | 0.4589 | 0.4021 |
|        | 0.4589 | 0.4021 |        | 0.4641 | 0.4112 |        | 0.4700 | 0.4126 |        | 0.4646 | 0.4034 |
|        | 0.4538 | 0.3931 |        | 0.4589 | 0.4021 |        | 0.4646 | 0.4034 |        | 0.4593 | 0.3944 |

**CREE'S STANDARD COOL WHITE KITS PLOTTED ON ANSI STANDARD CHROMATICITY REGIONS**

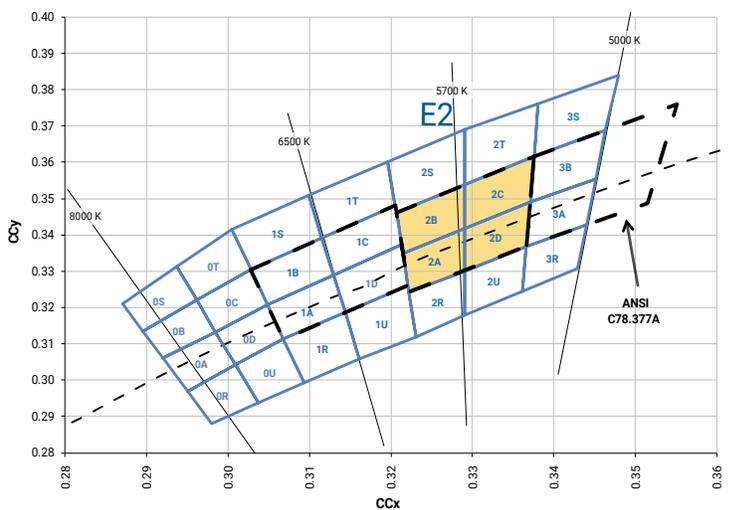
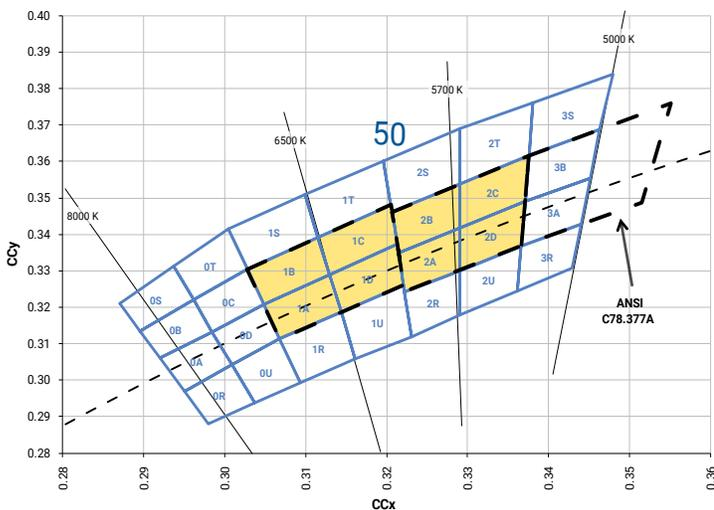
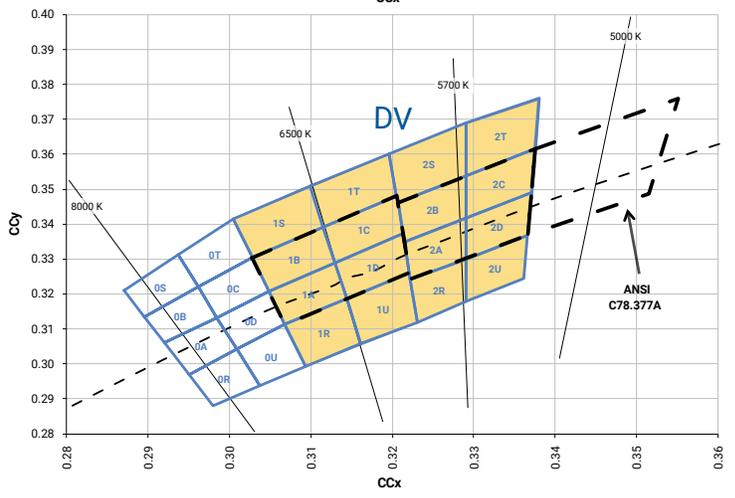
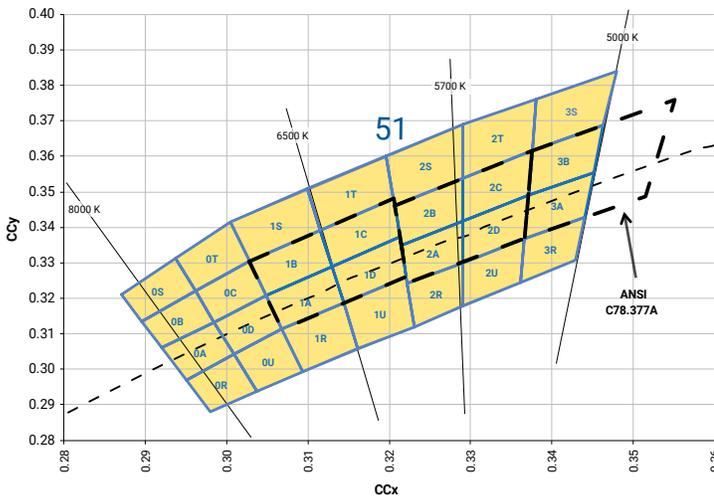
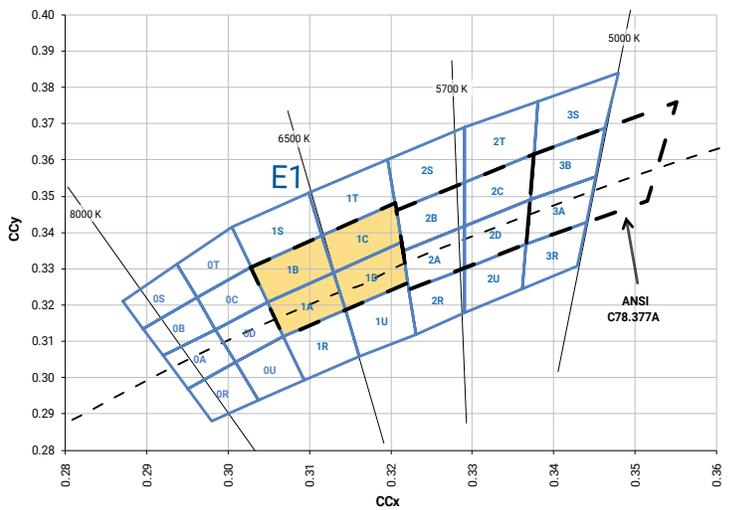
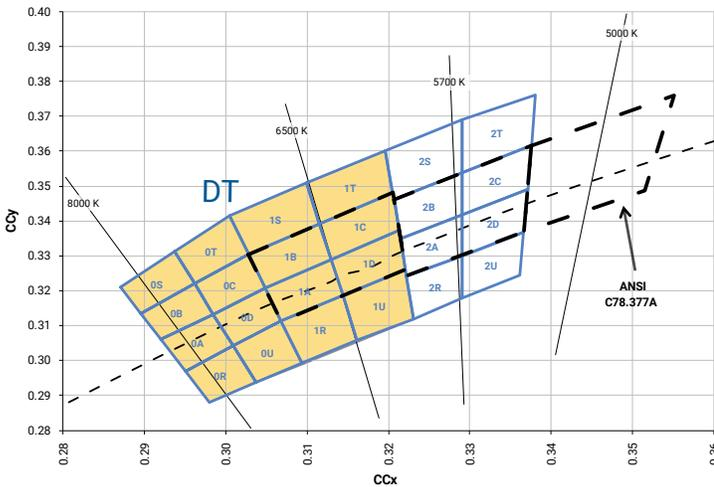

**CREE'S STANDARD COOL WHITE KITS PLOTTED ON ANSI STANDARD CHROMATICITY REGIONS - CONTINUED**

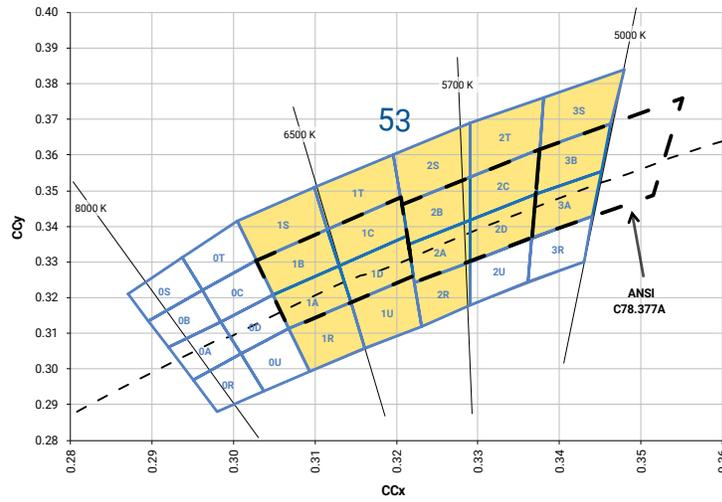

**CREE'S STANDARD WARM AND NEUTRAL WHITE KITS PLOTTED ON ANSI STANDARD CHROMATICITY REGIONS**

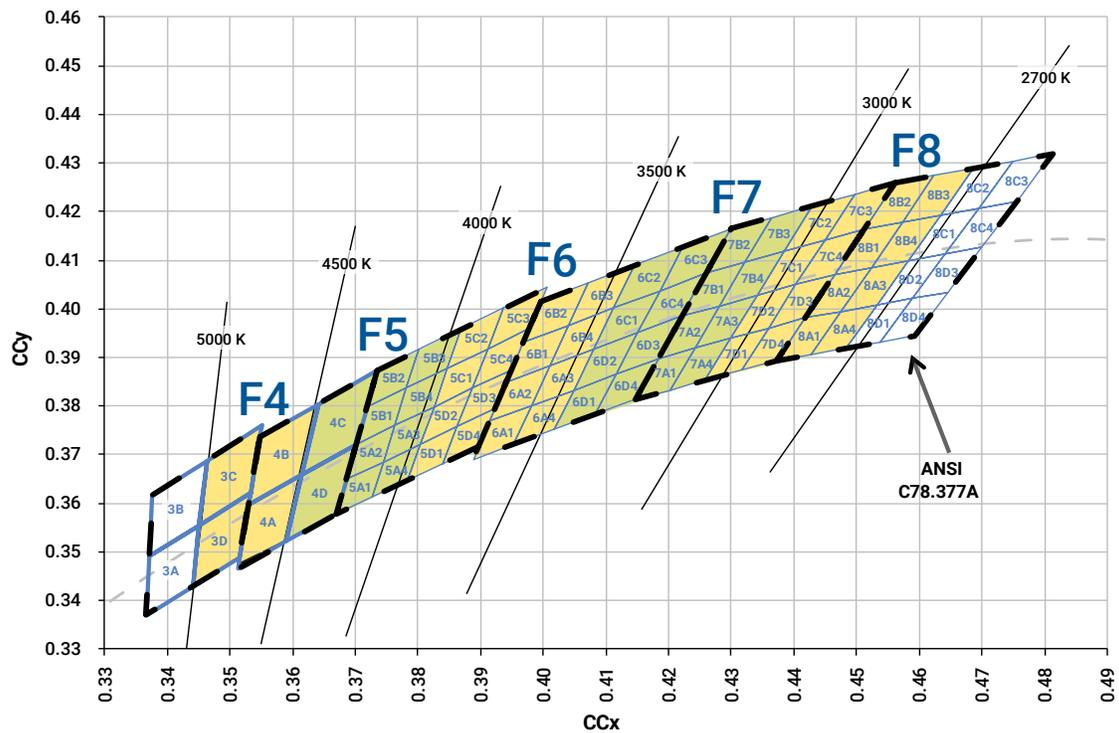
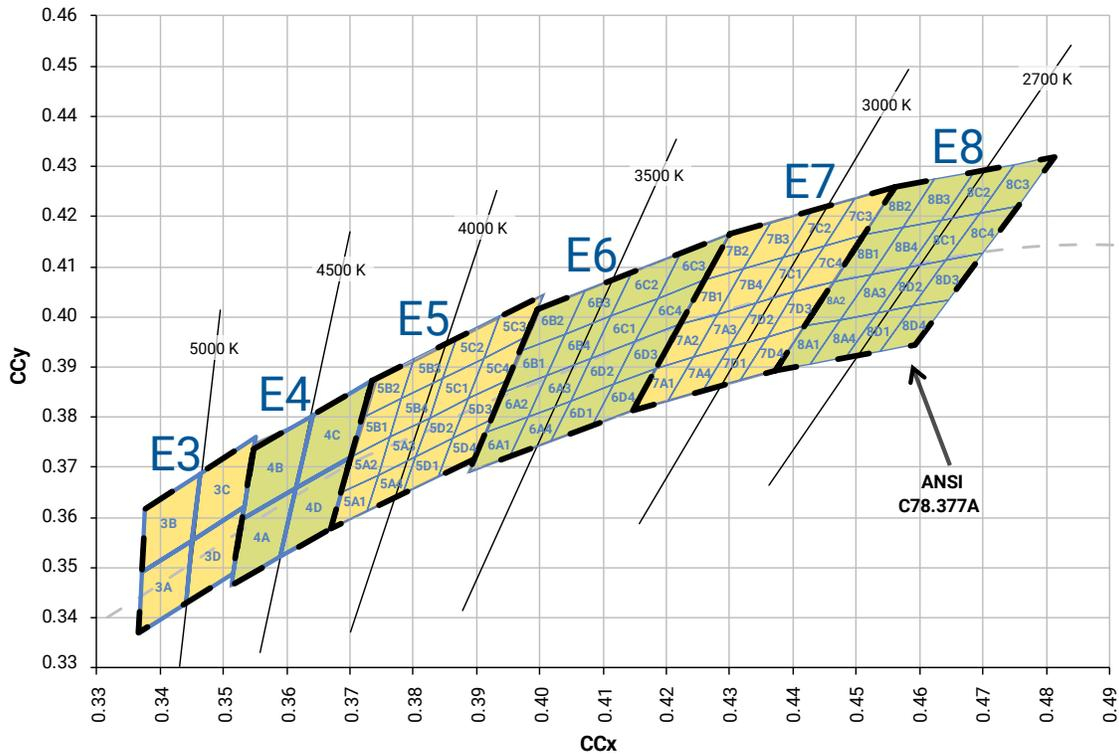

**CREE'S STANDARD WARM AND NEUTRAL WHITE KITS PLOTTED ON ANSI STANDARD CHROMATICITY REGIONS - CONTINUED**

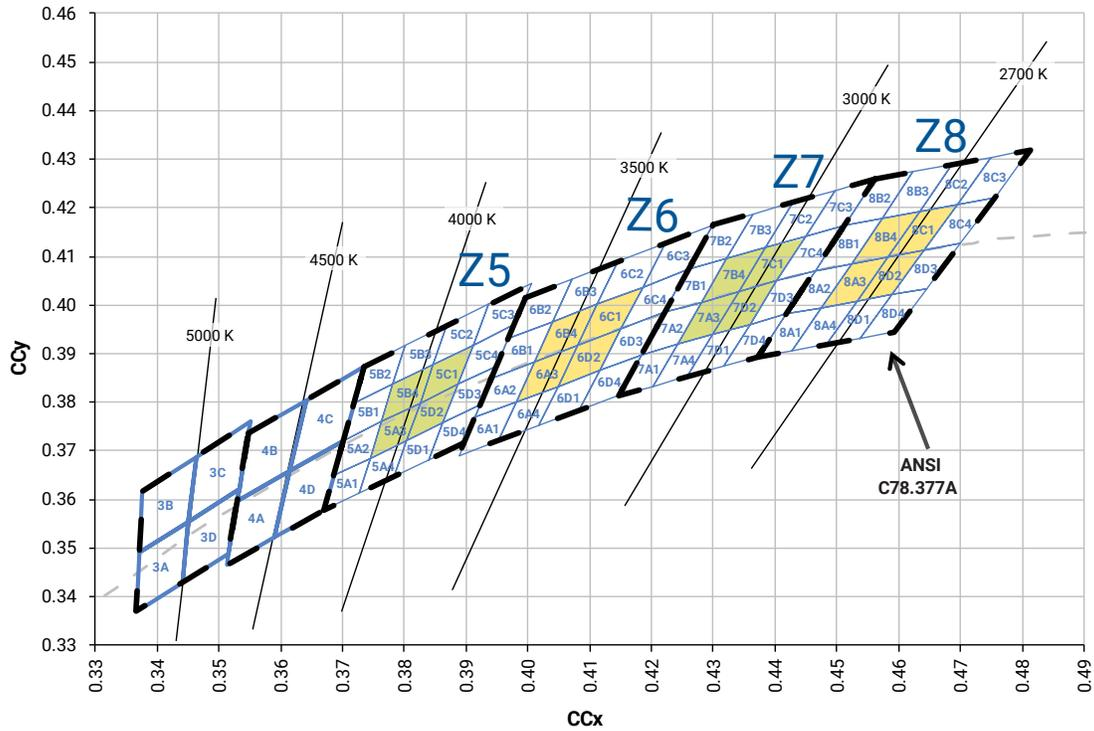

**CREE'S STANDARD CHROMATICITY KITS**

The following table provides the chromaticity bins associated with chromaticity kits.

| Color         | CCT    | Kit | Chromaticity Bins                                                                                              |
|---------------|--------|-----|----------------------------------------------------------------------------------------------------------------|
| Cool White    | 7000 K | DT  | 0A, 0B, 0C, 0D, 0R, 0S, 0T, 0U, 1A, 1B, 1C, 1D, 1R, 1S, 1T, 1U                                                 |
|               | 6200 K | 51  | 0A, 0B, 0C, 0D, 0R, 0S, 0T, 0U, 1A, 1B, 1C, 1D, 1R, 1S, 1T, 1U, 2A, 2B, 2C, 2D, 2R, 2S, 2T, 2U, 3A, 3B, 3R, 3S |
|               | 6000 K | 53  | 1A, 1B, 1C, 1D, 1R, 1S, 1T, 1U, 2A, 2B, 2C, 2D, 2R, 2S, 2T, 3A, 3B, 3S                                         |
|               | 6000 K | 50  | 1A, 1B, 1C, 1D, 2A, 2B, 2C, 2D                                                                                 |
|               | 6500 K | E1  | 1A, 1B, 1C, 1D                                                                                                 |
|               | 6000 K | DV  | 1A, 1B, 1C, 1D, 1R, 1S, 1T, 1U, 2A, 2B, 2C, 2D, 2R, 2S, 2T, 2U                                                 |
|               | 5700 K | E2  | 2A, 2B, 2C, 2D                                                                                                 |
| Neutral White | 5000 K | E3  | 3A, 3B, 3C, 3D                                                                                                 |
|               | 4750 K | F4  | 3C, 3D, 4A, 4B                                                                                                 |
|               | 4500 K | E4  | 4A, 4B, 4C, 4D                                                                                                 |
|               | 4250 K | F5  | 4C, 4D, 5A1, 5A2, 5A3, 5A4, 5B1, 5B2, 5B3, 5B4                                                                 |
|               | 4000 K | E5  | 5A1, 5A2, 5A3, 5A4, 5B1, 5B2, 5B3, 5B4, 5C1, 5C2, 5C3, 5C4, 5D1, 5D2, 5D3, 5D4                                 |
|               | 4000 K | Z5  | 5A3, 5B4, 5C1, 5D2                                                                                             |
| Warm White    | 3750 K | F6  | 5C1, 5C2, 5C3, 5C4, 5D1, 5D2, 5D3, 5D4, 6A1, 6A2, 6A3, 6A4, 6B1, 6B2, 6B3, 6B4                                 |
|               | 3500 K | E6  | 6A1, 6A2, 6A3, 6A4, 6B1, 6B2, 6B3, 6B4, 6C1, 6C2, 6C3, 6C4, 6D1, 6D2, 6D3, 6D4                                 |
|               | 3500 K | Z6  | 6A3, 6B4, 6C1, 6D2                                                                                             |
|               | 3250 K | F7  | 6C1, 6C2, 6C3, 6C4, 6D1, 6D2, 6D3, 6D4, 7A1, 7A2, 7A3, 7A4, 7B1, 7B2, 7B3, 7B4                                 |
|               | 3000 K | E7  | 7A1, 7A2, 7A3, 7A4, 7B1, 7B2, 7B3, 7B4, 7C1, 7C2, 7C3, 7C4, 7D1, 7D2, 7D3, 7D4                                 |
|               | 3000 K | Z7  | 7A3, 7B4, 7C1, 7D2                                                                                             |
|               | 2850 K | F8  | 7C1, 7C2, 7C3, 7C4, 7D1, 7D2, 7D3, 7D4, 8A1, 8A2, 8A3, 8A4, 8B1, 8B2, 8B3, 8B4                                 |
|               | 2700 K | E8  | 8A1, 8A2, 8A3, 8A4, 8B1, 8B2, 8B3, 8B4, 8C1, 8C2, 8C3, 8C4, 8D1, 8D2, 8D3, 8D4                                 |
|               | 2700 K | Z8  | 8A3, 8B4, 8C1, 8D2                                                                                             |

**BIN AND ORDER CODE FORMATS**

XP-G2 bin codes and order codes are configured in the following manner:

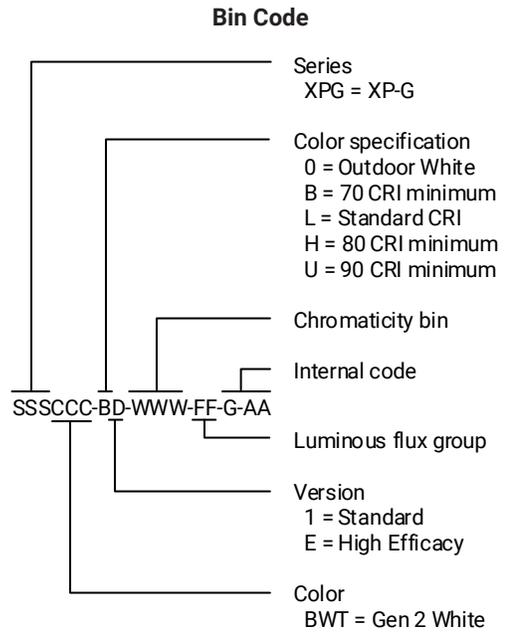
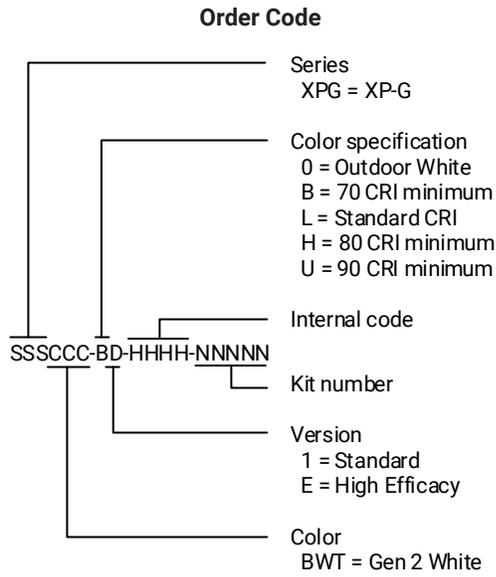

REFLOW SOLDERING CHARACTERISTICS

In testing, Cree has found XLamp XP-G2 LEDs to be compatible with JEDEC J-STD-020C, using the parameters listed below. As a general guideline, Cree recommends that users follow the recommended soldering profile provided by the manufacturer of the solder paste used, and therefore it is the lamp or luminaire manufacturer’s responsibility to determine applicable soldering requirements.

Note that this general guideline may not apply to all PCB designs and configurations of reflow soldering equipment.

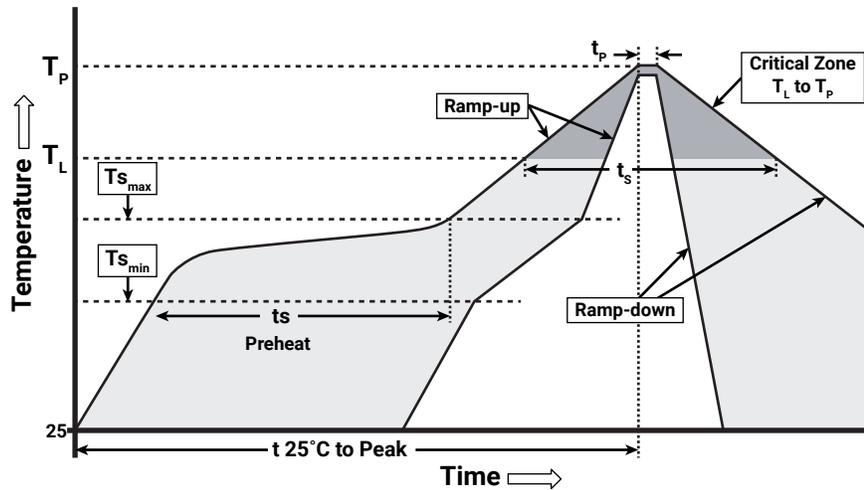

IPC/JEDEC J-STD-020C

| Profile Feature                                       | Lead-Free Solder |
|-------------------------------------------------------|------------------|
| Average Ramp-Up Rate ( $Ts_{max}$ to $T_P$ )          | 1.2 °C/second    |
| Preheat: Temperature Min ( $Ts_{min}$ )               | 120 °C           |
| Preheat: Temperature Max ( $Ts_{max}$ )               | 170 °C           |
| Preheat: Time ( $ts_{min}$ to $ts_{max}$ )            | 65-150 seconds   |
| Time Maintained Above: Temperature ( $T_L$ )          | 217 °C           |
| Time Maintained Above: Time ( $t_s$ )                 | 45-90 seconds    |
| Peak/Classification Temperature ( $T_P$ )             | 235 - 245 °C     |
| Time Within 5 °C of Actual Peak Temperature ( $t_p$ ) | 20-40 seconds    |
| Ramp-Down Rate                                        | 1 - 6 °C/second  |
| Time 25 °C to Peak Temperature                        | 4 minutes max.   |

Note: All temperatures refer to topside of the package, measured on the package body surface.

## NOTES

---

### Measurements

The luminous flux, radiant power, chromaticity, forward voltage and CRI measurements in this document are binning specifications only and solely represent product measurements as of the date of shipment. These measurements will change over time based on a number of factors that are not within Cree's control and are not intended or provided as operational specifications for the products. Calculated values are provided for informational purposes only and are not intended or provided as specifications.

### Pre-Release Qualification Testing

Please read the [LED Reliability Overview](#) for details of the qualification process Cree applies to ensure long-term reliability for XLamp LEDs and details of Cree's pre-release qualification testing for XLamp LEDs.

### Lumen Maintenance

Cree now uses standardized IES LM-80-08 and TM-21-11 methods for collecting long-term data and extrapolating LED lumen maintenance. For information on the specific LM-80 data sets available for this LED, refer to the public [LM-80 results document](#).

Please read the [Long-Term Lumen Maintenance application note](#) for more details on Cree's lumen maintenance testing and forecasting. Please read the [Thermal Management application note](#) for details on how thermal design, ambient temperature, and drive current affect the LED junction temperature.

### Moisture Sensitivity

Cree recommends keeping XLamp LEDs in the provided, resealable moisture-barrier packaging (MBP) until immediately prior to soldering. Unopened MBPs that contain XLamp LEDs do not need special storage for moisture sensitivity.

Once the MBP is opened, XLamp XP-G2 LEDs may be stored as MSL 1 per JEDEC J-STD-033, meaning they have unlimited floor life in conditions of  $\leq 30$  °C/85% relative humidity (RH). Regardless of the storage condition, Cree recommends sealing any unsoldered LEDs in the original MBP.

### RoHS Compliance

The levels of RoHS restricted materials in this product are below the maximum concentration values (also referred to as the threshold limits) permitted for such substances, or are used in an exempted application, in accordance with EU Directive 2011/65/EC (RoHS2), as implemented January 2, 2013. RoHS Declarations for this product can be obtained from your Cree representative or from the [Product Ecology](#) section of the Cree website.

### REACH Compliance

REACH substances of very high concern (SVHCs) information is available for this product. Since the European Chemical Agency (ECHA) has published notice of their intent to frequently revise the SVHC listing for the foreseeable future, please contact a Cree representative to insure you get the most up-to-date REACH Declaration. REACH banned substance information (REACH Article 67) is also available upon request.

**NOTES - CONTINUED**

---

**UL® Recognized Component**

This product meets the requirements to be considered a UL Recognized Component with Level 4 enclosure consideration. The LED package or a portion thereof has been investigated as a fire and electrical enclosure per ANSI/UL 8750.

**Vision Advisory**

**WARNING:** Do not look at an exposed lamp in operation. Eye injury can result. For more information about LEDs and eye safety, please refer to the [LED Eye Safety application note](#).

**MECHANICAL DIMENSIONS ( $T_A = 25\text{ }^\circ\text{C}$ )**

Thermal vias, if present, are not shown on these drawings.

All measurements are  $\pm .13\text{ mm}$  unless otherwise indicated.

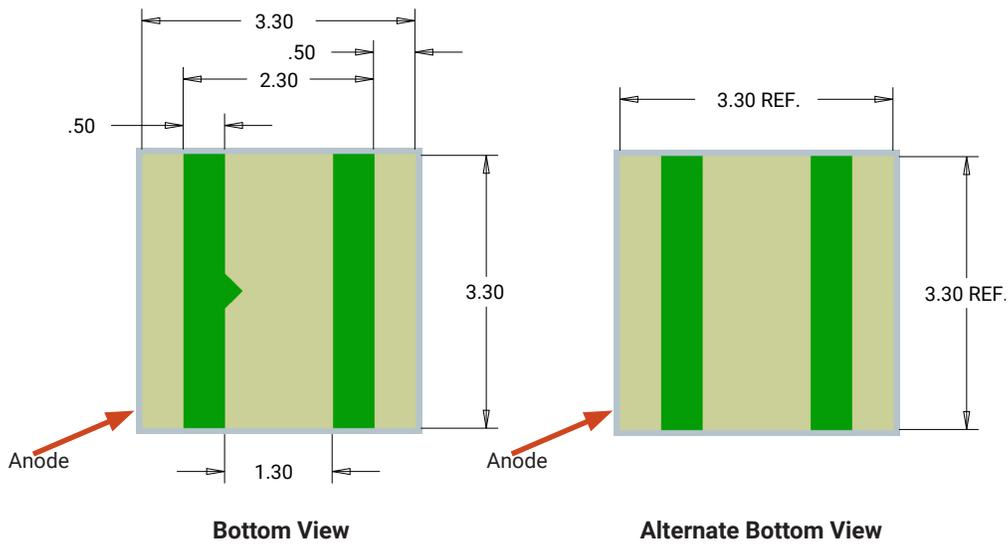
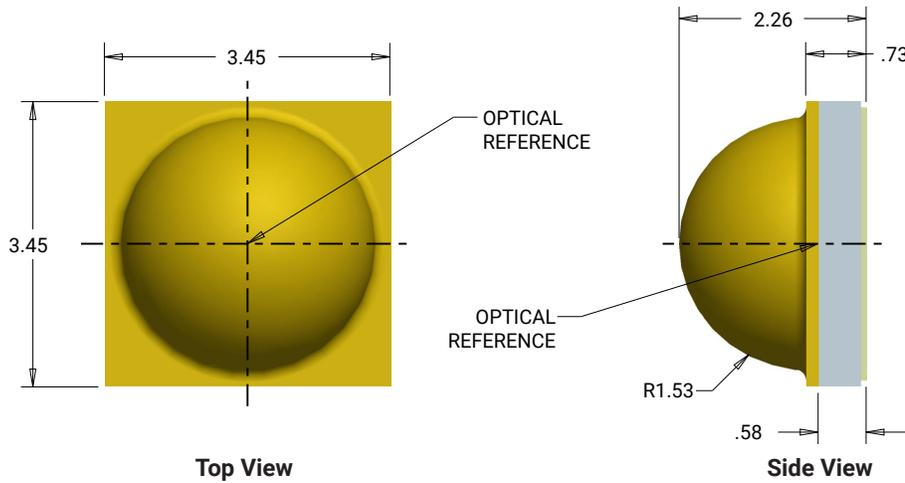

MECHANICAL DIMENSIONS (T<sub>A</sub> = 25 °C) - CONTINUED

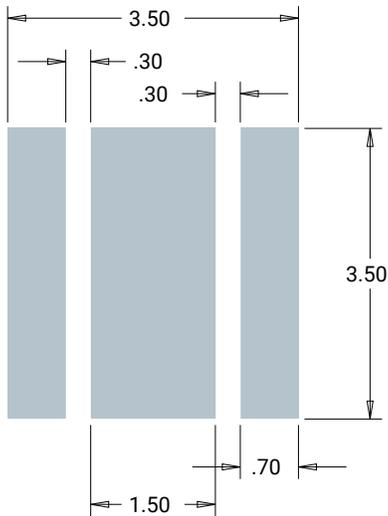

Recommended Copper Layout

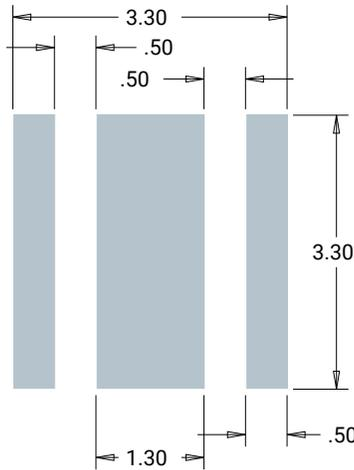

Recommended Solder Pad  
(Solder Mask Pattern)

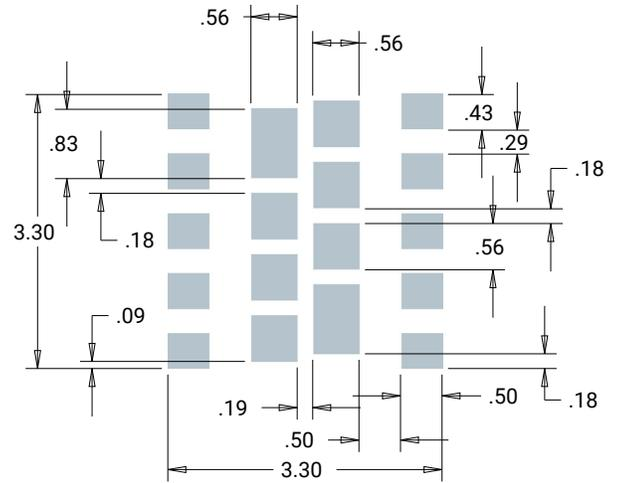

Recommended Stencil Openings\*

Notes:

- Cree recommends using thermal pad kickouts to maximize component thermal performance.
- Cree recommends using white solder mask material to minimize system optical loss.
- \* This stencil has been tested and optimized for the avoidance of voiding when using ALPHA® LUMET® P30 Maxrel solder paste. For other solder pastes, a “window pane” design for the thermal pad stencil may result in a lower voiding percentage. Contact your local Cree Field Applications Engineer for consultation regarding your specific application.

**TAPE AND REEL**

All Cree carrier tapes conform to EIA-481D, Automated Component Handling Systems Standard.

All dimensions in mm.

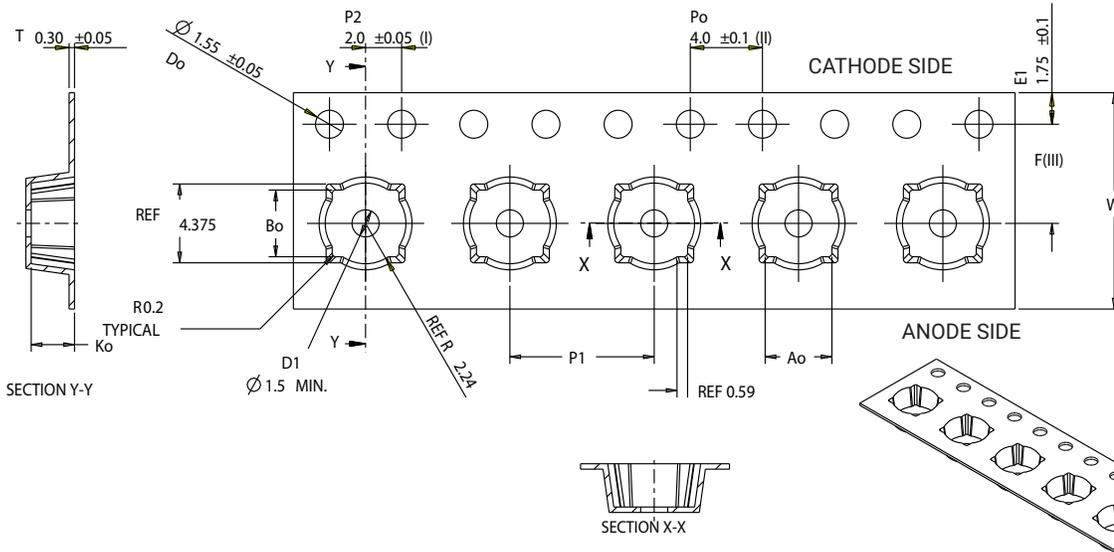

|     |       |           |
|-----|-------|-----------|
| Ao  | 3.70  | +/- 0.1   |
| Bo  | 3.70  | +/- 0.1   |
| Ko  | 2.40  | +0.0/-0.1 |
| F   | 5.50  | +/- 0.05  |
| P 1 | 8.00  | +/- 0.1   |
| W   | 12.00 | +0.3/-0.1 |

- (I) Measured from centerline of sprocket hole to centerline of pocket.
- (II) Cumulative tolerance of 10 sprocket holes is ±0.20.
- (III) Measured from centerline of sprocket hole to centerline of pocket.
- (IV) Other material available.

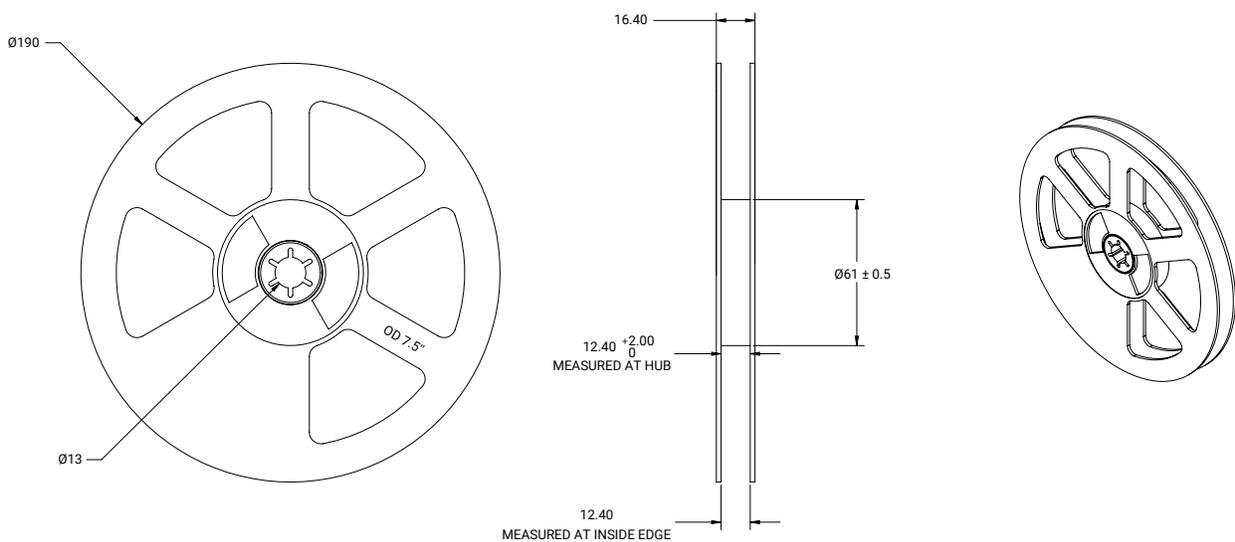
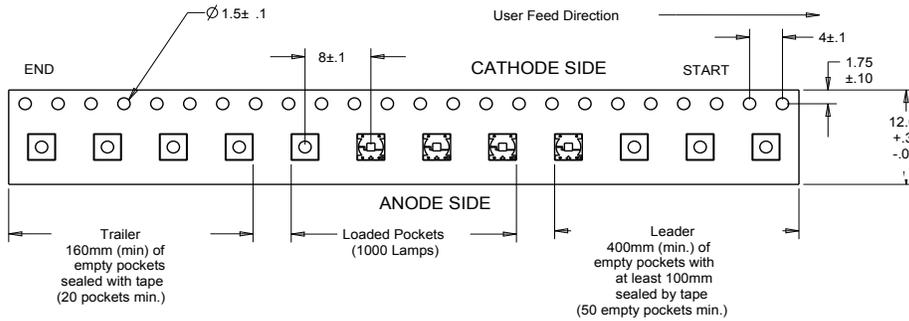

**PACKAGING**

**Unpackaged Reel**

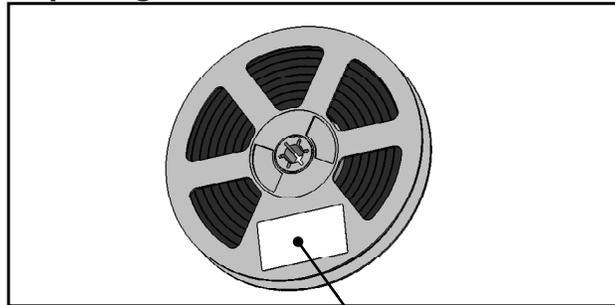

Label with Cree Bin Code,  
Quantity, Reel ID

**Packaged Reel**

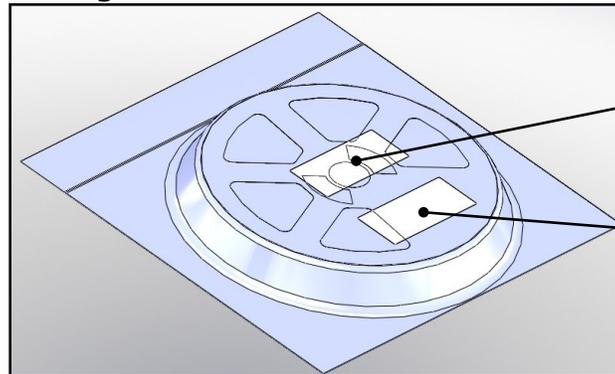

Label with Cree Order Code,  
Quantity, Reel ID, PO #

Label with Cree Bin Code,  
Quantity, Reel ID

**Boxed Reel**

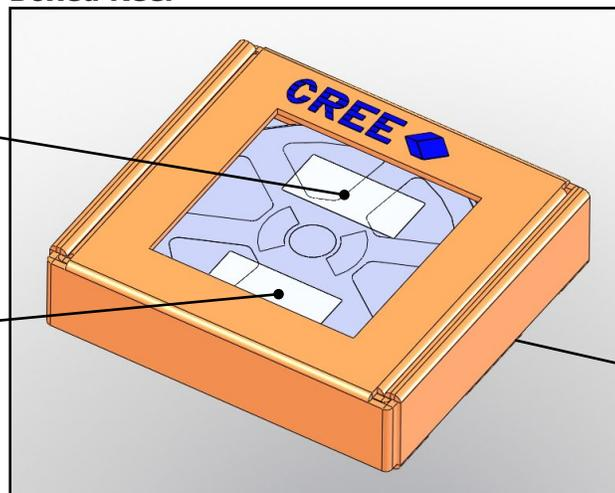

Label with Cree Order Code,  
Quantity, Reel ID, PO #

Label with Cree Bin Code,  
Quantity, Reel ID

Patent Label  
(on bottom of box)



Компания «ЭлектроПласт» предлагает заключение долгосрочных отношений при поставках импортных электронных компонентов на взаимовыгодных условиях!

Наши преимущества:

- Оперативные поставки широкого спектра электронных компонентов отечественного и импортного производства напрямую от производителей и с крупнейших мировых складов;
- Поставка более 17-ти миллионов наименований электронных компонентов;
- Поставка сложных, дефицитных, либо снятых с производства позиций;
- Оперативные сроки поставки под заказ (от 5 рабочих дней);
- Экспресс доставка в любую точку России;
- Техническая поддержка проекта, помощь в подборе аналогов, поставка прототипов;
- Система менеджмента качества сертифицирована по Международному стандарту ISO 9001;
- Лицензия ФСБ на осуществление работ с использованием сведений, составляющих государственную тайну;
- Поставка специализированных компонентов (Xilinx, Altera, Analog Devices, Intersil, Interpoint, Microsemi, Aeroflex, Peregrine, Syfer, Eurofarad, Texas Instrument, Miteq, Cobham, E2V, MA-COM, Hittite, Mini-Circuits, General Dynamics и др.);

Помимо этого, одним из направлений компании «ЭлектроПласт» является направление «Источники питания». Мы предлагаем Вам помощь Конструкторского отдела:

- Подбор оптимального решения, техническое обоснование при выборе компонента;
- Подбор аналогов;
- Консультации по применению компонента;
- Поставка образцов и прототипов;
- Техническая поддержка проекта;
- Защита от снятия компонента с производства.



#### Как с нами связаться

**Телефон:** 8 (812) 309 58 32 (многоканальный)

**Факс:** 8 (812) 320-02-42

**Электронная почта:** [org@eplast1.ru](mailto:org@eplast1.ru)

**Адрес:** 198099, г. Санкт-Петербург, ул. Калинина, дом 2, корпус 4, литера А.