



Features

- Frequency Range 3000MHz to 3800MHz
- Full Internal Matching and No External Bias Inductors
- 6-Bit Digital Step Attenuator
- SPI Serial Control Programming
- Max Gain = 38dB at 3500MHz
- Gain Control Range = 31.5dB (0.5dB Step Size)
- High OIP3/P1dB = +40.5/30dBm Type
- Single +5V Supply
- Small 28-Pin, 6.0mm x 6.0mm, MCM
- Power-up Programming

Applications

- Cellular, 3G Infrastructure
- WiBro, WiMax, LTE
- Microwave Radio
- High Linearity Power Control

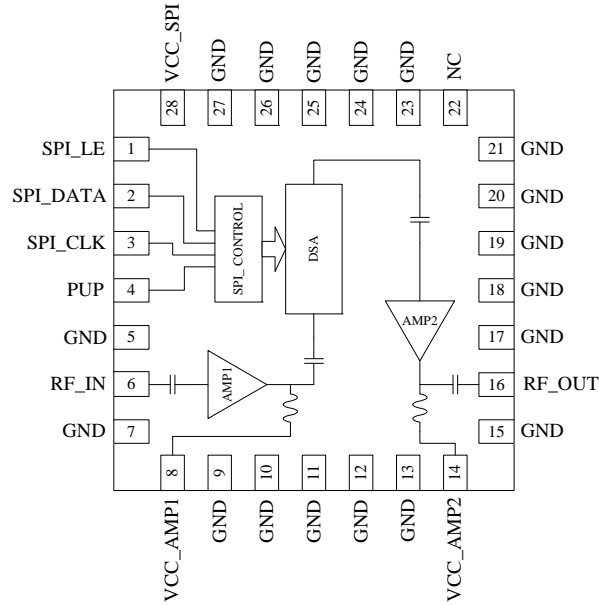

Functional Block Diagram

Product Description

RFMD's RFDA3016 is a digital controlled variable gain amplifier featuring high linearity over the entire gain control range with noise figure less than 5.0dB in its maximum gain state. The gain of the 6-bit digital step attenuator is programmed with a serial mode control interface (SPI). The RFDA3016 is packaged in a small 6.0mm x 6.0mm leadless laminate MCM, which contains plated through thermal vias for ultra-low thermal resistance. This module is easy to use with no external matching components required.

Ordering Information

| | |
|-----------------|---|
| RFDA3016SQ | Sample bag with 25 pieces |
| RFDA3016SR | 7" Reel with 100 pieces |
| RFDA3016TR13 | 13" Reel with 2500 pieces |
| RFDA3016PCK-410 | 3000MHz to 3800MHz PCBA with 5-piece sample bag |

Absolute Maximum Ratings

| Parameter | Rating | Unit |
|--|-----------------|-----------------|
| Supply Voltage | 5.5 | V _{DC} |
| DC Supply Current | 1000 | mA |
| Power Dissipation | 5.5 | W |
| Max RF Input Power for 50Ω Output Load | +24 | dBm |
| Operating Temperature (T _{CASE}) | -40 to +85 | °C |
| Storage Temperature | -40 to +150 | °C |
| Junction Temperature | +165* | °C |
| ESD Rating (HBM) | 1000 (Class 1C) | V |
| Moisture Sensitivity Level | MSL3 | |

*MTTF > 1E6 hours at 165 °C junction temperature

Note: Operation of this device beyond any one of these limits may cause permanent damage.



Caution! ESD sensitive device.

Exceeding any one or a combination of the Absolute Maximum Rating conditions may cause permanent damage to the device. Extended application of Absolute Maximum Rating conditions to the device may reduce device reliability. Specified typical performance or functional operation of the device under Absolute Maximum Rating conditions is not implied.

The information in this publication is believed to be accurate and reliable. However, no responsibility is assumed by RF Micro Devices, Inc. ("RFMD") for its use, nor for any infringement of patents, or other rights of third parties, resulting from its use. No license is granted by implication or otherwise under any patent or patent rights of RFMD. RFMD reserves the right to change component circuitry, recommended application circuitry and specifications at any time without prior notice.



RFMD Green: RoHS compliant per EU Directive 2002/95/EC, halogen free per IEC 61249-2-21, < 1000ppm each of antimony trioxide in polymeric materials and red phosphorus as a flame retardant, and <2% antimony in solder.

Nominal Operating Parameters

| Parameter | Specification | | | Unit | Condition |
|----------------------|---------------------------------|------|------|------|---|
| | Min. | Typ. | Max. | | |
| Overall | | | | | Temp = 25 °C, V _{CC} = V _{DD} = 5V, standard application circuit |
| Frequency Range | 3000 | | 3800 | MHz | |
| Max Gain | | 38 | | dB | Attenuation = 0dB, at 3500MHz |
| Gain Control Range | | 31.5 | | dB | |
| Step Accuracy | ±(0.2 +15% attenuation setting) | | | dB | Major state error up to 3800MHz |
| P1dB | | 30.4 | | dBm | Attenuation = 0dB, at 3500MHz |
| Output IP3 | 34.6 | 40.5 | | dBm | P _{OUT} = 10dBm/Tone, 1MHz spacing at 3500MHz, minimum value occurs at low temperature |
| Control Interface | | 6 | | bit | SPI Interface |
| Settling Time | | 250 | | ns | t _{ON} , t _{OFF} (10%/90% RF) |
| Noise Figure | | 4.8 | | dB | Attenuation = 0dB, 3500MHz |
| Impedance | | 50 | | Ω | |
| Input Return Loss | | 19 | | dB | At 3500MHz |
| Output Return Loss | | 11 | | dB | |
| Total Supply Voltage | 4.75 | 5.0 | 5.25 | V | |
| Supply Current | | 250 | | mA | From V _{CC} (SPI), V _{CC} (AMP1), and V _{CC} (AMP2) |
| Thermal Resistance | | 30 | | °C/W | Junction to backside of device |

Typical RF Performance at Key Operating Frequencies

| Parameter | Unit | 3000MHz | 3300MHz | 3400MHz | 3500MHz | 3600MHz | 3700MHz | 3800MHz |
|-----------------------|------|---------|---------|---------|---------|---------|---------|---------|
| Max Small Signal Gain | dB | 36.6 | 37.6 | 38.0 | 38.1 | 37.9 | 37.3 | 36.0 |
| Output P1dB | dBm | 31.5 | 31.4 | 31.0 | 30.4 | 30.0 | 29.4 | 28.6 |
| Output IP3* | dBm | 36.3 | 39.4 | 39.4 | 40.5 | 40.8 | 41.5 | 41.1 |
| Input Return Loss | dB | 15.8 | 19.8 | 19.7 | 19.8 | 21.1 | 23.0 | 22.2 |
| Output Return Loss | dB | 12.6 | 10.7 | 10.6 | 11.2 | 12.4 | 13.1 | 12.1 |
| Noise Figure | dB | 4.8 | 4.8 | 4.8 | 4.8 | 4.9 | 5.0 | 5.0 |

*Note: OIP3 is tested at P_{OUT} = 10dBm/Tone and 1MHz spacing

Typical Performance

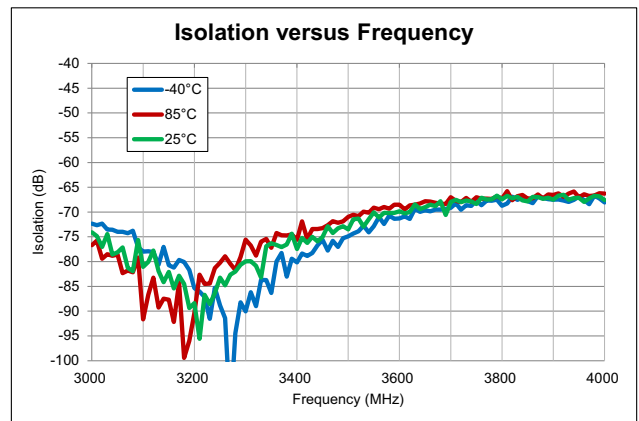
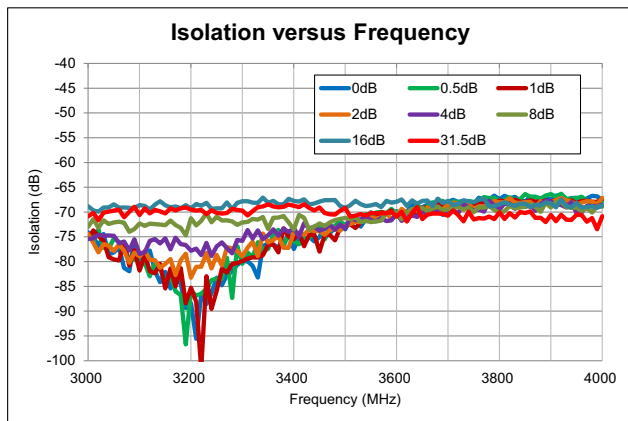
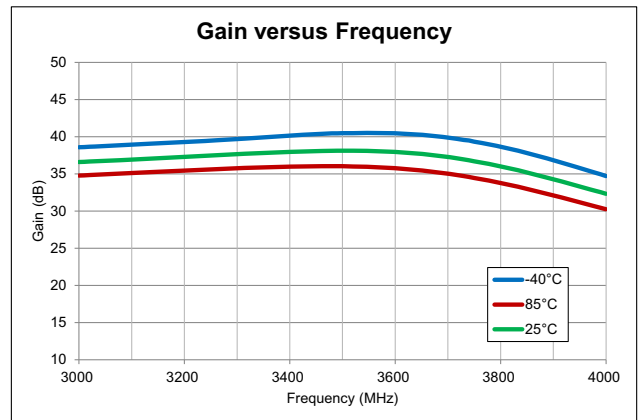
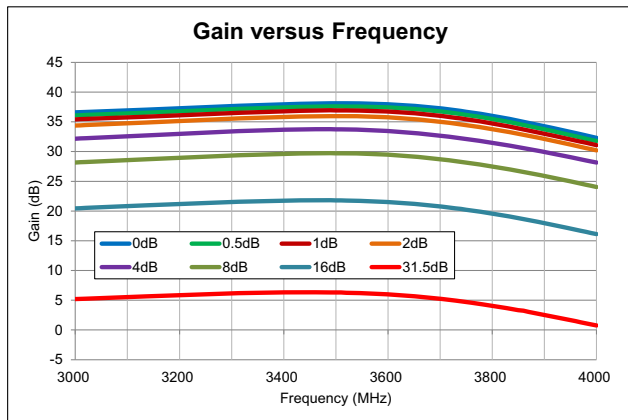
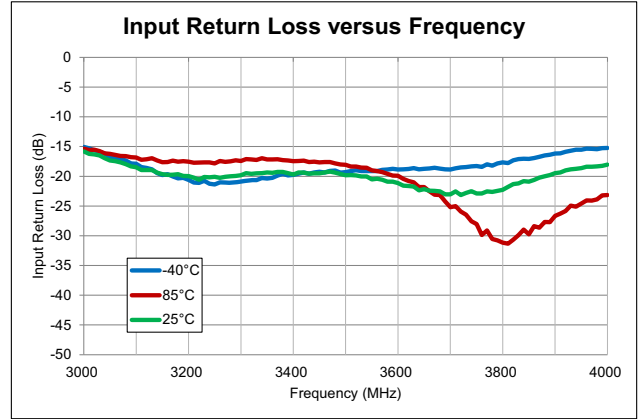
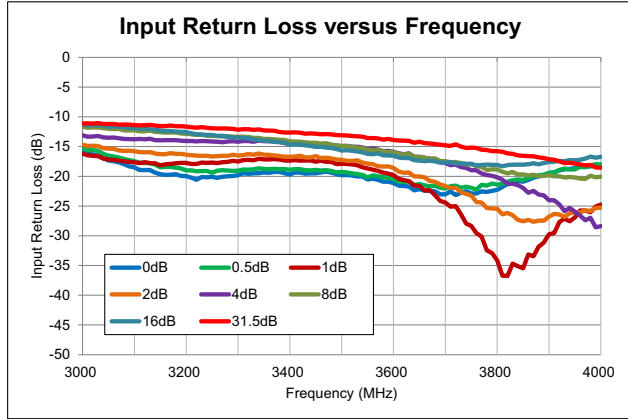

Typical Performance

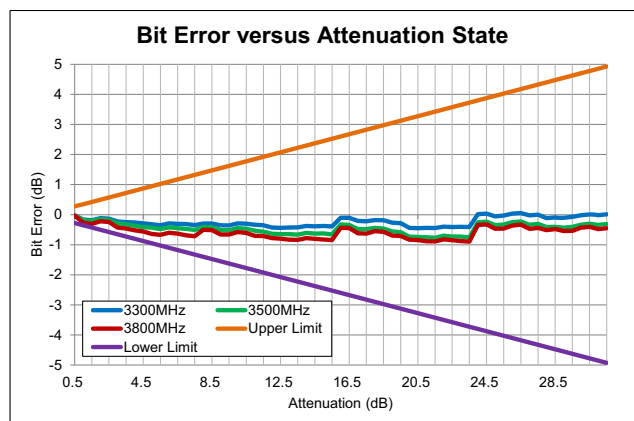
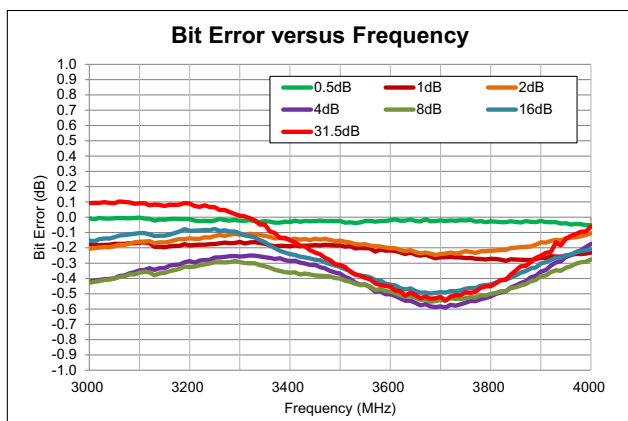
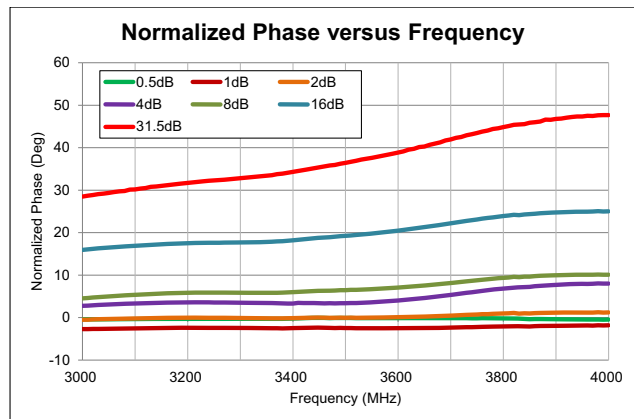
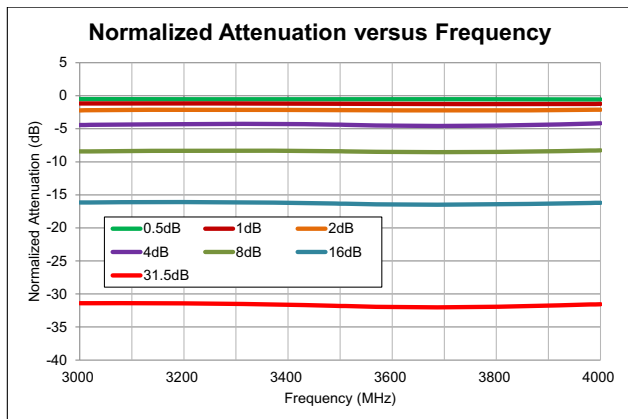
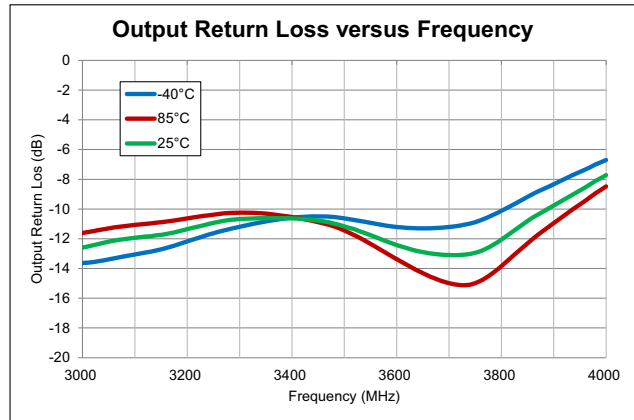
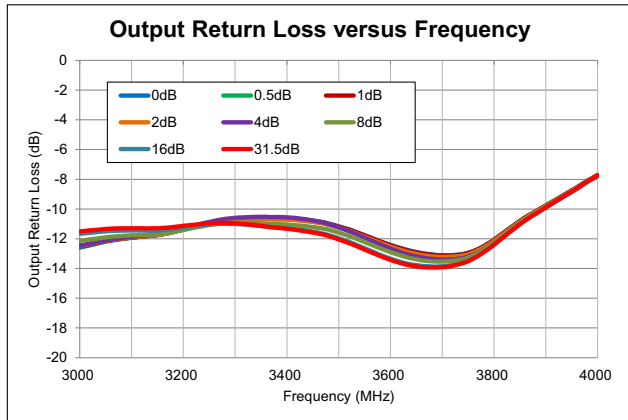

Typical Performance

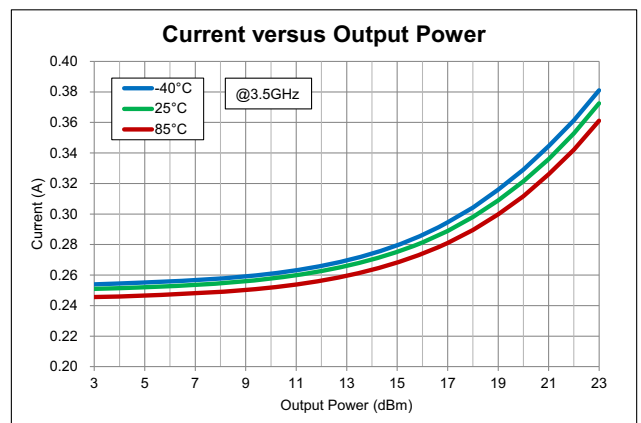
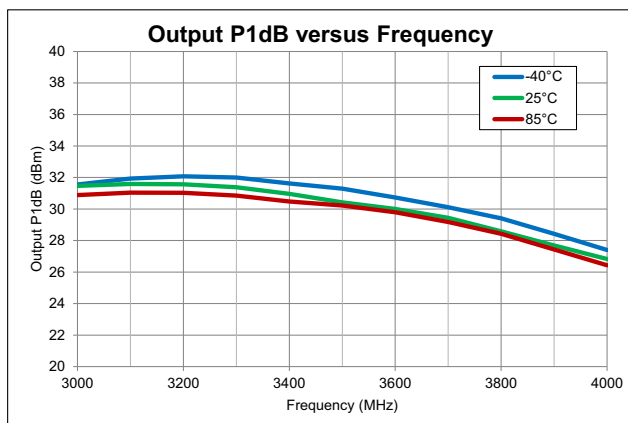
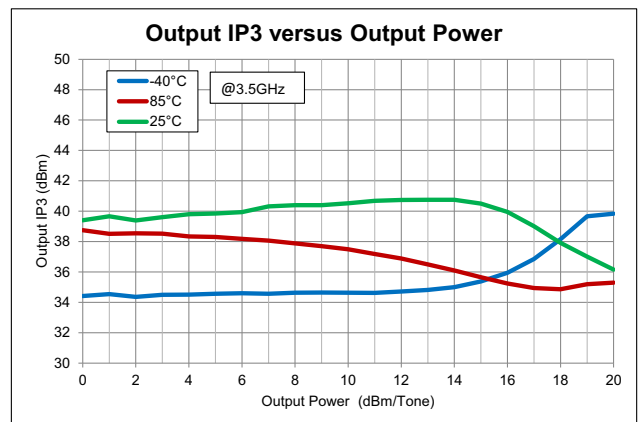
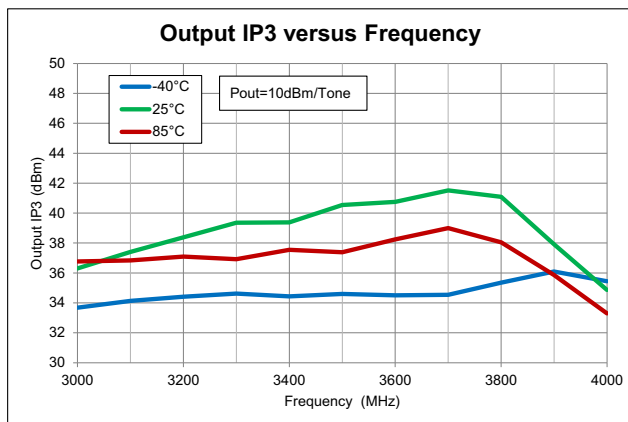
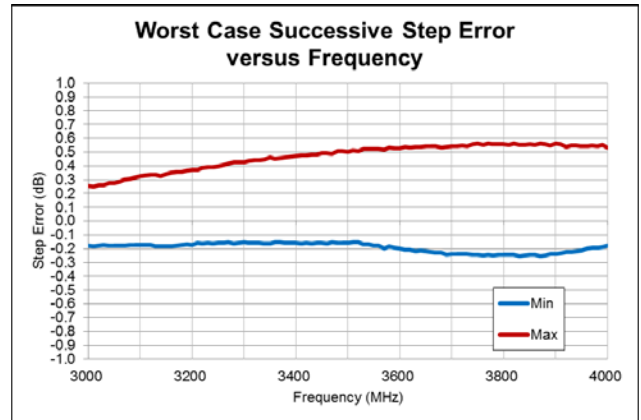
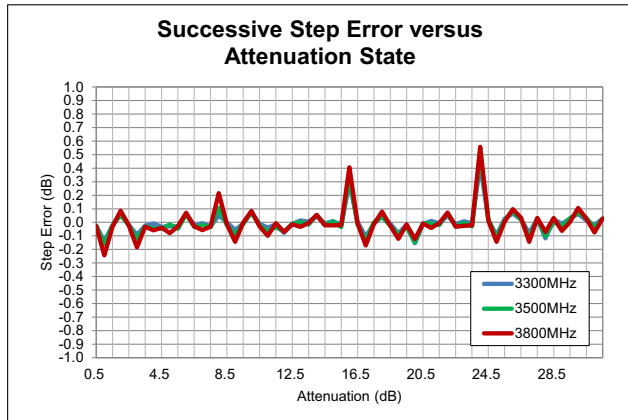

Truth Table

| Control Bit | | | | | | Gain Relative to Max Gain |
|-------------|----|----|----|----|----|---------------------------|
| D5 | D4 | D3 | D2 | D1 | D0 | |
| 1 | 1 | 1 | 1 | 1 | 1 | 0dB |
| 1 | 1 | 1 | 1 | 1 | 0 | -0.5dB |
| 1 | 1 | 1 | 1 | 0 | 1 | -1dB |
| 1 | 1 | 1 | 0 | 1 | 1 | -2dB |
| 1 | 1 | 0 | 1 | 1 | 1 | -4dB |
| 1 | 0 | 1 | 1 | 1 | 1 | -8dB |
| 0 | 1 | 1 | 1 | 1 | 1 | -16dB |
| 0 | 0 | 0 | 0 | 0 | 0 | -31.5dB |

Serial Port Interface: SPI Timing Diagram

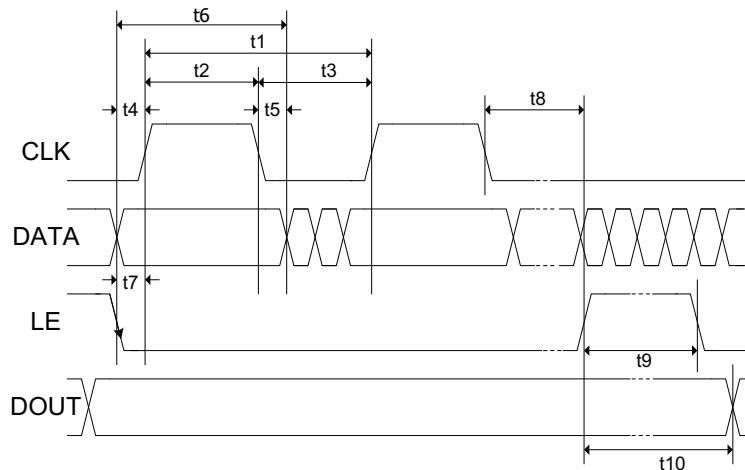

SPI Timing Diagram Specifications

| Parameter | Limit | Unit | Comment |
|-----------|-------|---------|------------------------|
| t1 | 25 | MHz max | CLK Frequency |
| t2 | 20 | ns min | CLK High |
| t3 | 20 | ns min | CLK Low |
| t4 | 5 | ns min | DATA to CLK Setup Time |
| t5 | 5 | ns min | DATA to CLK Hold Time |
| t6 | 30 | ns min | DATA Valid |
| t7 | 5 | ns min | LE to CLK Setup Time |
| t8 | 5 | ns min | CLK to LE Setup Time |
| t9 | 10 | ns min | LE Pulse Width |
| t10 | 20 | ns max | Output Set |

Programming Example - 6-Bit

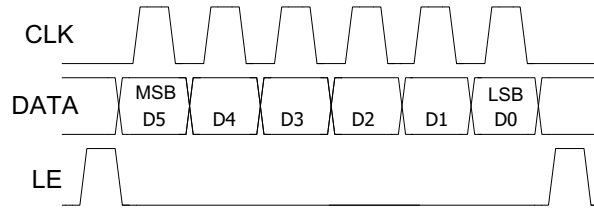

| Control Voltage Table | |
|-----------------------|--------------|
| State | Logic |
| Low | 0V to 0.8V |
| High | 2.0V to 5.0V |

| Power-up Programming Truth Table | |
|----------------------------------|----------------------------|
| PUP | Attenuator Setting |
| Low | Attenuation at Max, 31.5dB |
| High | Attenuation at Min, 0dB |

Evaluation Board Schematic

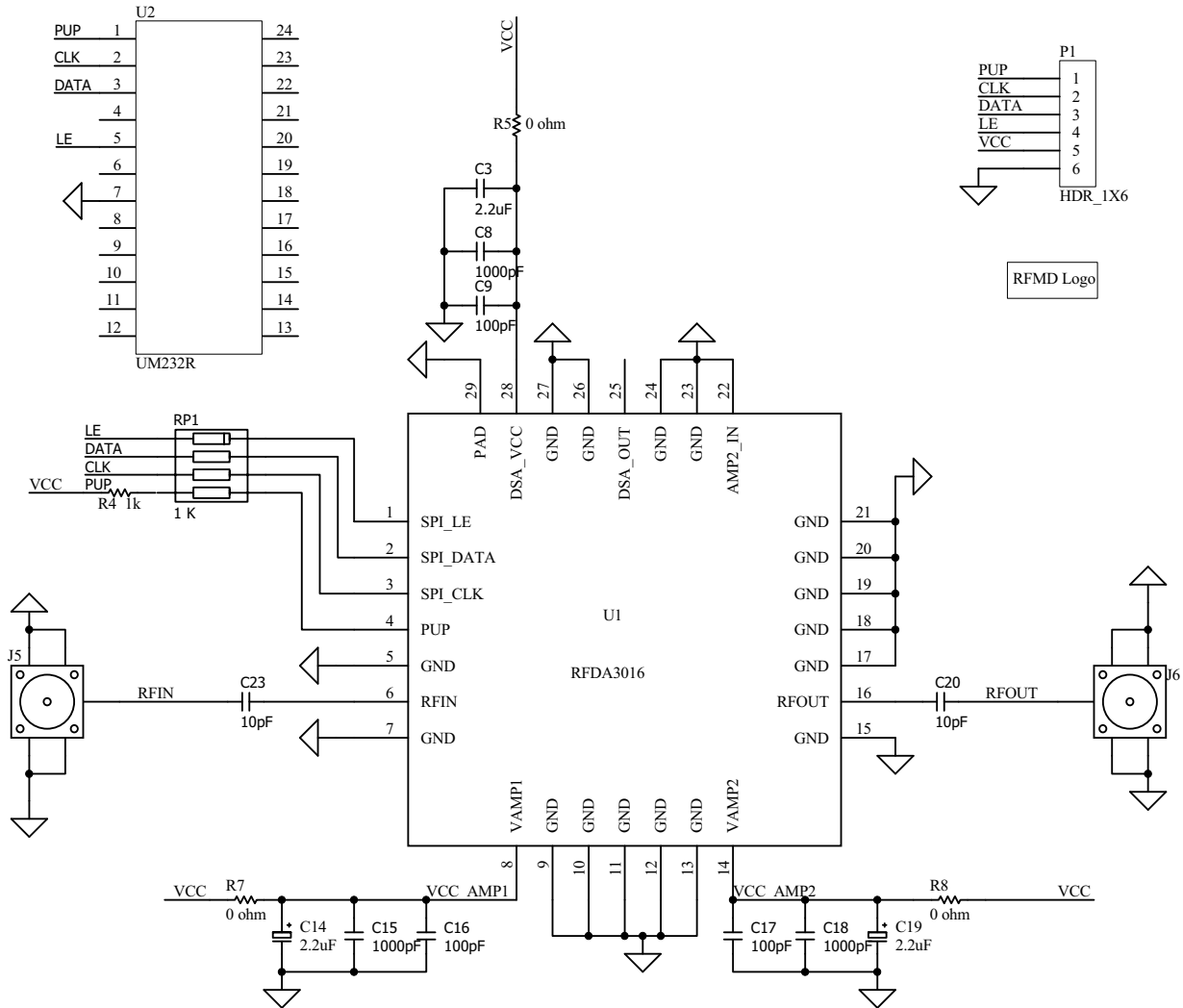

Evaluation Board Bill of Materials (BOM)

| Description | Reference Designator | Manufacturer | Manufacturer's P/N |
|--|----------------------|-----------------------------|--------------------|
| RFDA3016, 6mm x 6sq. mm, 28-Pin Laminate | U1 | RFMD | RFDA3016 |
| RFDA3016 Evaluation Board | | | RFDA3016EV(B) |
| RES ARRAY, 4-ELEM, 1K, 5%, SMD 4x0402 | RP1 | KOA Speer Electronics, Inc. | CN1E4KTTD102J |
| RES, 1K, 5%, 1/16W, 0603 | R4 | Panasonic Industrial Co. | ERJ-3GEYJ102 |
| CAP, 100pF, 5%, 50V, COG, 0402 | C9, C16-C17 | Murata Electronics | GRM1555C1H101JA01D |
| CAP, 1000pF, 10%, 50V, X7R, 0402 | C8, C15, C18 | Murata Electronics | GRM155R71H102KA01D |
| CAP, 2.2µF, 10%, 10V, X7R, 0603 | C3, C14, C19 | TDK Corporation | C1608X7R1A225K |
| CAP, 10pF, 5%, 50V, COG, 0402 | C20, C23 | Murata Electronics | GRM1555C1H100JA01D |
| RES, 0Ω, 0603 | R5, R7-R8 | KOA Speer Electronics, Inc. | RK73Z1JLTD |
| CONN, SMA, END LNCH, FLT, 0.062" | J5-J6 | Emerson Network Power | 142-0701-821 |
| CONN, HDR, ST, PLRZD, 6-PIN, 0.100" | P1 | AMP | 640454-6 |
| DNP | U2 | | |

Evaluation Board Assembly Drawing

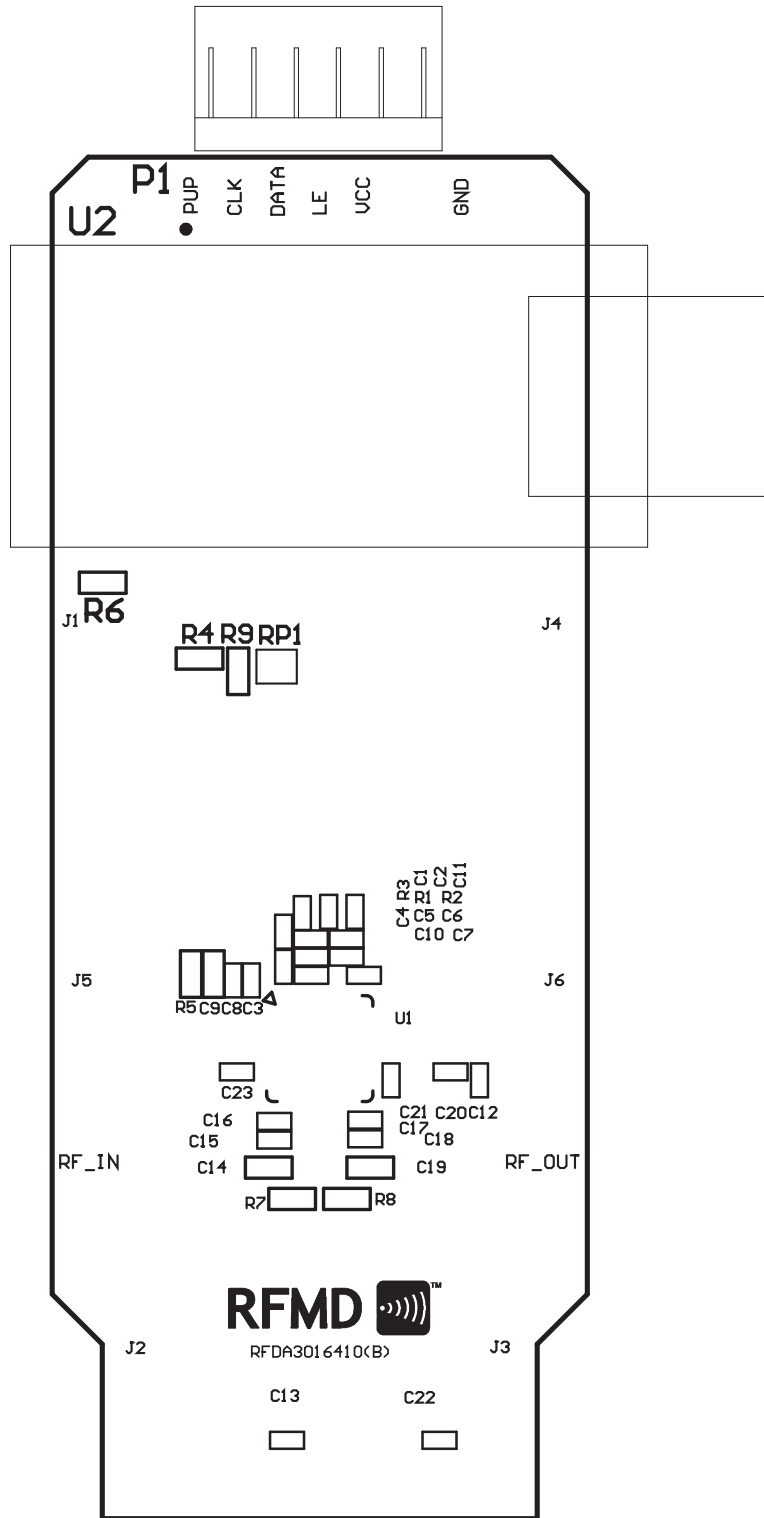

Pin Names and Description

| Pin | Function | Description |
|-----|----------|-------------------------------------|
| 1 | SPI_LE | Serial Latch Enable Input |
| 2 | SPI_DATA | Serial Data Input |
| 3 | SPI_CLK | Serial Clock Input |
| 4 | PUP | Power-up Programming Pin |
| 5 | GND | RF/DC Ground Connection |
| 6 | RF_IN | RF Input, AC Coupled |
| 7 | GND | RF/DC Ground Connection |
| 8 | VCC_AMP1 | Supply Voltage for Amplifier 1 |
| 9 | GND | RF/DC Ground Connection |
| 10 | GND | RF/DC Ground Connection |
| 11 | GND | RF/DC Ground Connection |
| 12 | GND | RF/DC Ground Connection |
| 13 | GND | RF/DC Ground Connection |
| 14 | VCC_AMP2 | Supply Voltage for Amplifier 2 |
| 15 | GND | RF/DC Ground Connection |
| 16 | RF_OUT | RF Output, AC Coupled |
| 17 | GND | RF/DC Ground Connection |
| 18 | GND | RF/DC Ground Connection |
| 19 | GND | RF/DC Ground Connection |
| 20 | GND | RF/DC Ground Connection |
| 21 | GND | RF/DC Ground Connection |
| 22 | NC | Do Not Connect, Leave Open Circuit |
| 23 | GND | RF/DC Ground Connection |
| 24 | GND | RF/DC Ground Connection |
| 25 | GND | RF/DC Ground Connection |
| 26 | GND | RF/DC Ground Connection |
| 27 | GND | RF/DC Ground Connection |
| 28 | VCC_SPI | Supply Voltage for SPI and DSA Chip |

Package Drawing:
6.0mm x 6.0mm Laminate Module

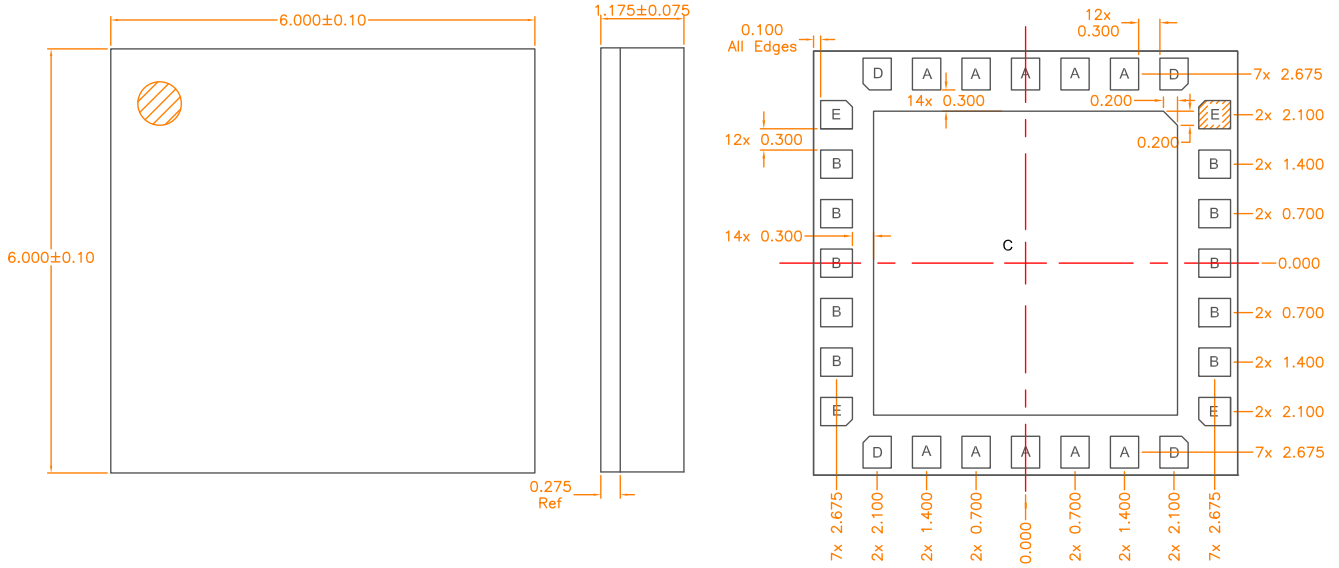

- A = 0.400 x 0.450 mm
- B = 0.450 x 0.400 mm
- C = 4.300 x 4.300 mm
- D = See Details
- E = See Details

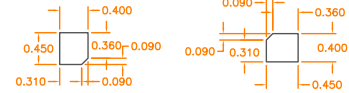

Detail D Pad
1x This rotation
1x Rotated 90°
1x Rotated 180°
1x Rotated 270°

Detail E Pad
1x This rotation
1x Rotated 90°
1x Rotated 180°
1x Rotated 270°

Notes:

1. Shaded area represents Pin 1 location.

Branding Diagram

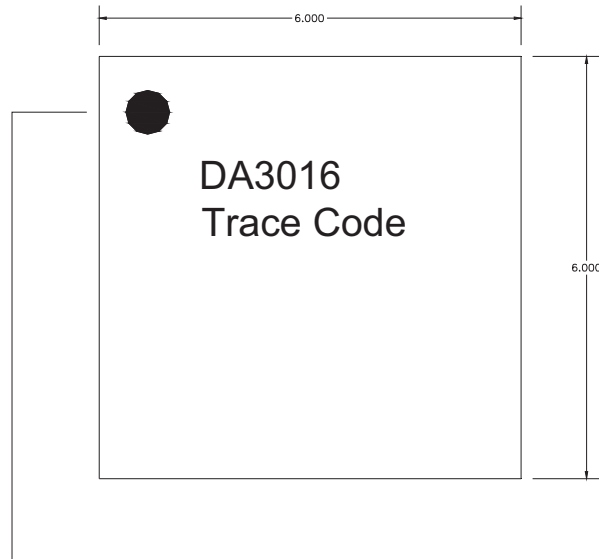

Pin 1 Indicator

Trace Code to be assigned by SubCon



Компания «ЭлектроПласт» предлагает заключение долгосрочных отношений при поставках импортных электронных компонентов на взаимовыгодных условиях!

Наши преимущества:

- Оперативные поставки широкого спектра электронных компонентов отечественного и импортного производства напрямую от производителей и с крупнейших мировых складов;
- Поставка более 17-ти миллионов наименований электронных компонентов;
- Поставка сложных, дефицитных, либо снятых с производства позиций;
- Оперативные сроки поставки под заказ (от 5 рабочих дней);
- Экспресс доставка в любую точку России;
- Техническая поддержка проекта, помощь в подборе аналогов, поставка прототипов;
- Система менеджмента качества сертифицирована по Международному стандарту ISO 9001;
- Лицензия ФСБ на осуществление работ с использованием сведений, составляющих государственную тайну;
- Поставка специализированных компонентов (Xilinx, Altera, Analog Devices, Intersil, Interpoint, Microsemi, Aeroflex, Peregrine, Syfer, Eurofarad, Texas Instrument, Miteq, Cobham, E2V, MA-COM, Hittite, Mini-Circuits, General Dynamics и др.);

Помимо этого, одним из направлений компании «ЭлектроПласт» является направление «Источники питания». Мы предлагаем Вам помощь Конструкторского отдела:

- Подбор оптимального решения, техническое обоснование при выборе компонента;
- Подбор аналогов;
- Консультации по применению компонента;
- Поставка образцов и прототипов;
- Техническая поддержка проекта;
- Защита от снятия компонента с производства.



Как с нами связаться

Телефон: 8 (812) 309 58 32 (многоканальный)

Факс: 8 (812) 320-02-42

Электронная почта: org@eplast1.ru

Адрес: 198099, г. Санкт-Петербург, ул. Калинина, дом 2, корпус 4, литера А.