

“ZNR” Surge Absorbers

Type: **SMD**

Series: **VF**



Features

- Large withstanding surge current capability, in compact size
- Designed for flow/reflow solderings
- Low clamping voltage
- RoHS compliant

Recommended Applications

- Protection of communication modules (Modem, xDSL, Terminal Adaptor)
- Protection of consumer, industrial equipment
- Absorption of switching surge from relays

Applicable Standards

- PCQC (GB/T10193, GB/T10194)
Registered in "Panasonic Part No."

As for Handling Precautions and Minimum Quantity / Packing Unit

Please see Related Information

Explanation of Part Numbers

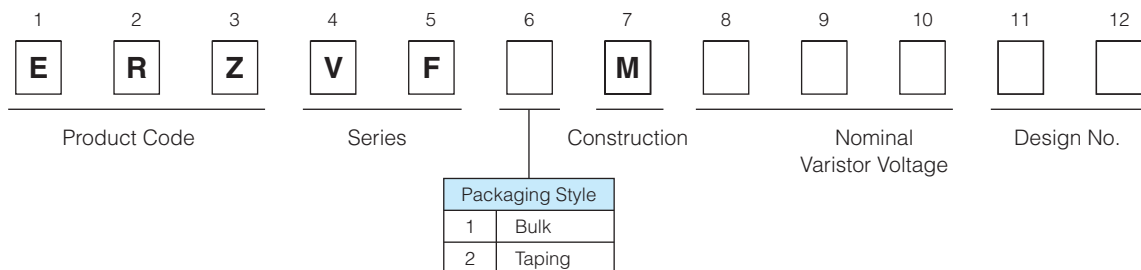

Construction

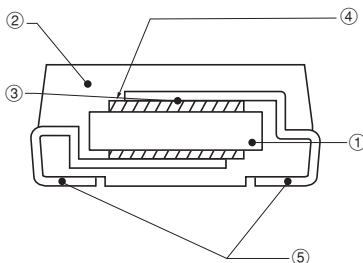

① ZNR element	ZnO etc.
② Resin mold	Epoxy Resin(UL94V-0 approved)
③ Conductive adhesive	Silver
④ Electrode	Silver
⑤ Lead terminals	Sn plated Ni-Fe Alloy

Dimensions in mm (not to scale)

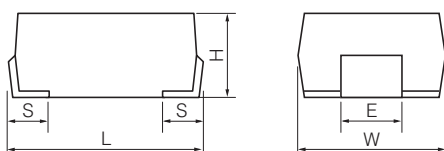

Unit : mm

Part No.	W	L	H	S	E
ERZVF□M□□□	6.0±0.4	8.0±0.5	3.2±0.3	1.3±0.3	2.5±0.2

Ratings and Characteristics

- Operating Temperature Range : -40 to 85 °C
- Storage Temperature Range : -40 to 125 °C

Part No.	Varistor Voltage	Maximum Allowable Voltage		Clamping Voltage at I _p (max.)		Rated Power (W)	Maximum Energy (2 ms) (J)	Maximum Peak Current (8/20 μs, 2 times) (A)
	V _{1mA} (V)	ACrms (V)	DC (V)	(V)	Measuring Current (A)			
ERZVF□M220	22(20 to 24)	14	18	43	2.5	0.02	0.9	125
ERZVF□M270	27(24 to 30)	17	22	53	2.5	0.02	1.0	125
ERZVF□M330	33(30 to 36)	20	26	65	2.5	0.02	1.2	125
ERZVF□M390	39(35 to 43)	25	31	77	2.5	0.02	1.5	125
ERZVF□M470	47(42 to 52)	30	38	93	2.5	0.02	1.8	125
ERZVF□M560	56(50 to 62)	35	45	110	2.5	0.02	2.2	125
ERZVF□M680	68(61 to 75)	40	56	135	2.5	0.02	2.5	125
ERZVF□M820	82(74 to 90)	50	65	135	10	0.25	3.5	600
ERZVF□M101	100(90 to 110)	60	85	165	10	0.25	4.0	600
ERZVF□M121	120(108 to 132)	75	100	200	10	0.25	5.0	600
ERZVF□M151	150(135 to 165)	95	125	250	10	0.25	6.0	600
ERZVF□M201	200(185 to 225)	130	170	340	10	0.25	8.0	600
ERZVF□M221	220(198 to 242)	140	180	360	10	0.25	9.0	600
ERZVF□M241	240(216 to 264)	150	200	395	10	0.25	10.0	600
ERZVF□M271	270(247 to 303)	175	225	455	10	0.25	12.0	600
ERZVF□M331	330(297 to 363)	210	270	545	10	0.1	8.0	300
ERZVF□M361	360(324 to 396)	230	300	595	10	0.1	9.0	300
ERZVF□M391	390(351 to 429)	250	320	650	10	0.1	9.0	300
ERZVF□M431	430(387 to 473)	275	350	710	10	0.1	10.0	300
ERZVF□M471	470(423 to 517)	300	385	775	10	0.1	10.0	300

Type VF□M

↑ Packaging Style Code: "1" for bulk, "2" for embossed taping

Typical Characteristics

Voltage vs. Current

ERZVF1(2)M220 to ERZVF1(2)M680

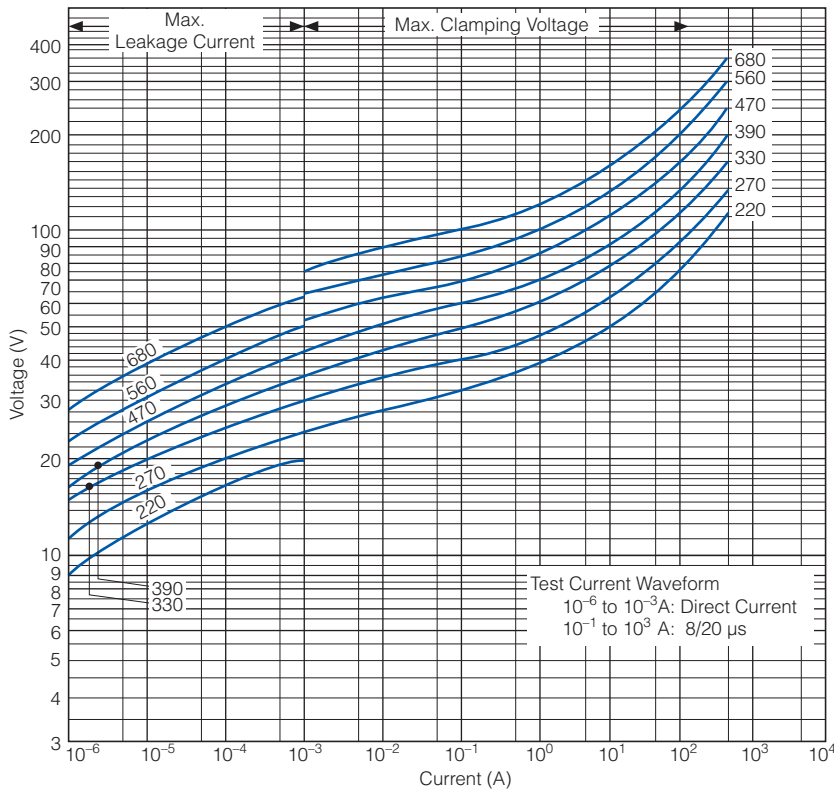

Impulse Derating (Relation between impulse width and impulse current multiple)

ERZVF1(2)M220 to ERZVF1(2)M680

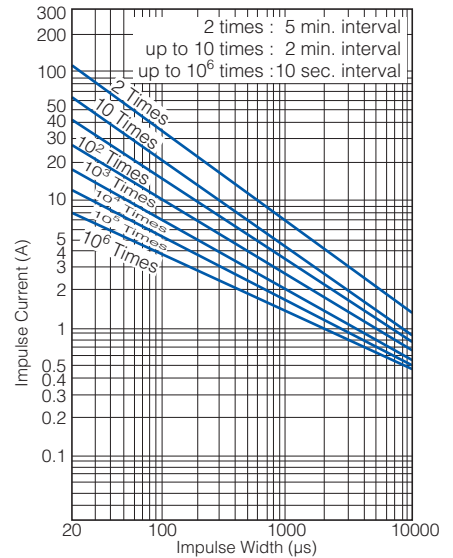

ERZVF1(2)M820 to ERZVF1(2)M471

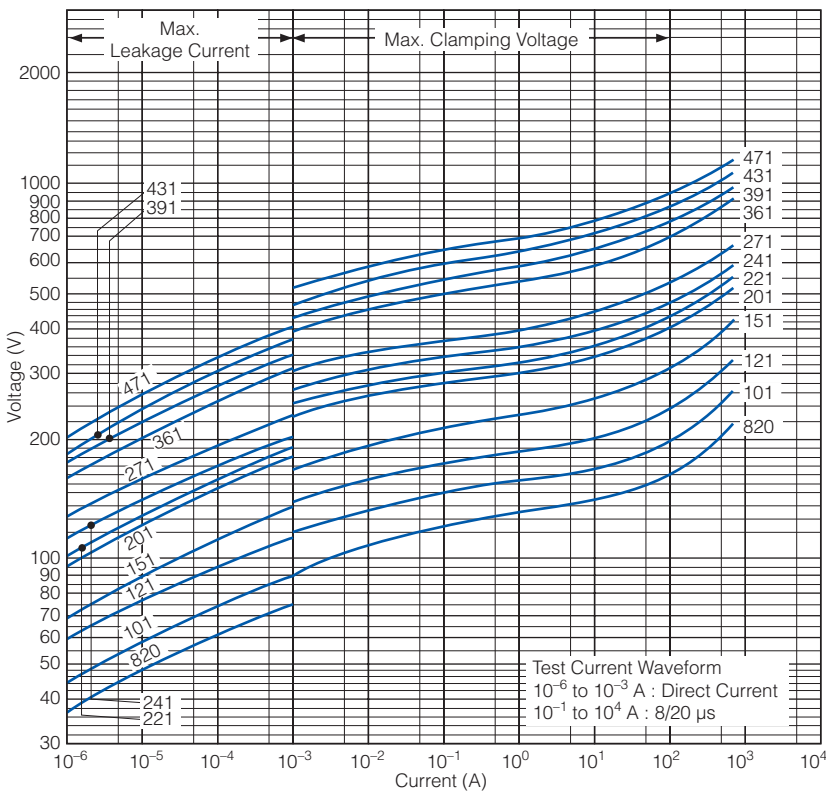

ERZVF1(2)M820 to ERZVF1(2)M271

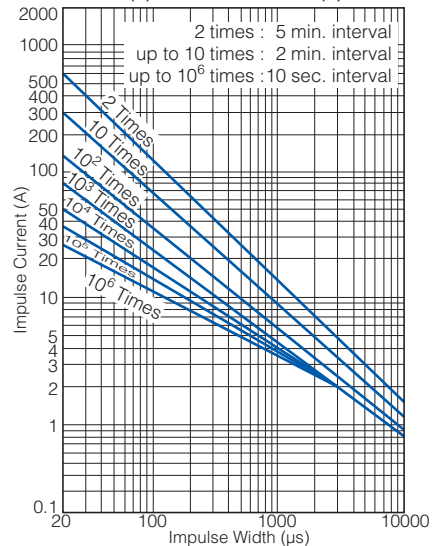

ERZVF1(2)M331 to ERZVF1(2)M471

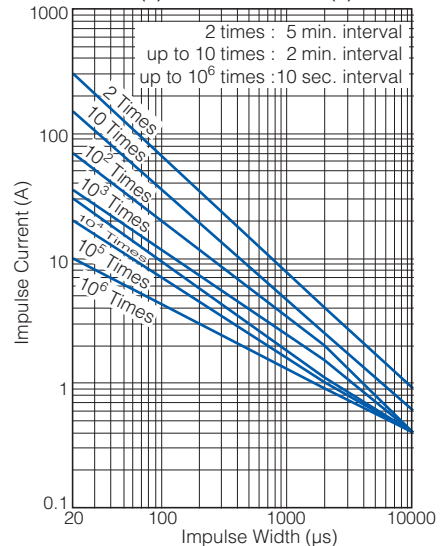

Marking Contents

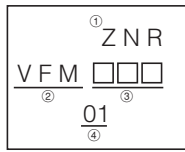

① Product Name	ZNR, ZNR Surge Absorbers
② Series	VF□M, VF Series
③ Abbreviation of Part No.	The first two digits are significant figures and the third one denotes the number of zeros following.
④ Date Code	Left*(Year) 2011:1, 2012:2, 2013:3, 2014:4, 2015:5, 2016:6 Right(Month) Jan. to Sep.:1 to 9, Oct.:O, Nov.:N, Dec.:D

* If the 10's digit of a Christian year is an even year, as an end abbreviation, an alphabetic character is used.
1 : A, 2 : B, 3 : C, 4 : D, 5 : E, 6 : F, 7 : G, 8 : H, 9 : J, 0 : K
If the 10's digit of a Christian year is an odd year, as an end abbreviation, a number is used.

Packaging Methods

● Packing Quantity

Style	Quantity
Embossed taping	2,000 pcs./reel
Bulk	200 pcs./bag

● Reel

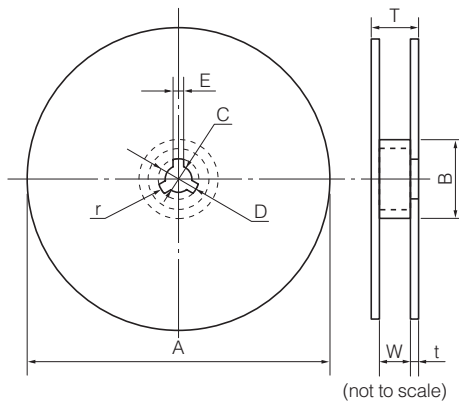

Part No.	A	B	C	D	E
ERZVF□M□□□□	382 max.	50 min.	13.0±0.5	21.0±0.8	2.0±0.5

Part No.	W	T	t	r
ERZVF□M□□□□	16.4 ^{+0.20}	22.4 max.	2.5±0.5	1.0

● Embossed Taping

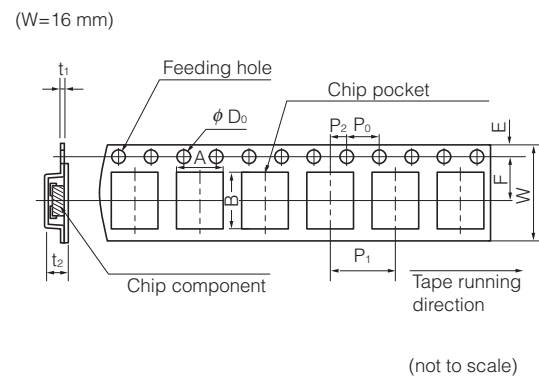

Part No.	A	B	W	F	E	P ₁
ERZVF□M□□□□	6.8±0.2	11.9 max.	16.0±0.3	7.5±0.10	1.75±0.10	8.0±0.1

Part No.	P ₂	P ₀	φD ₀	t ₁	t ₂
ERZVF□M□□□□	2.0±0.1	4.0±0.1	1.5 ^{+0.1}	0.6 max.	6.5 max.

Performance Characteristics

Characteristics	Test Methods	Specifications												
Standard Test Condition	Electrical measurements (initial/after tests) shall be conducted at temperature of 5 to 35 °C, relative humidity of maximum 85 %	—												
Varistor Voltage	The voltage between two terminals with the specified measuring current 1mA DC applied is called V_1 or V_{1mA} . The measurement should be made as fast as possible to avoid heat effects.	To meet the specified value.												
Maximum Allowable Voltage	The recommended maximum sinusoidal wave voltage (rms) or the maximum DC voltage that can be applied continuously.													
Clamping Voltage	The maximum voltage between two terminals with the specified impulse current (8/20 μ s).													
Rated Power	The maximum power that can be applied within the specified ambient temperature.													
Maximum Energy	Maximum energy of less than ± 10 % of the varistor voltage change when the standard impulse (2 ms) is applied one time.													
Maximum Peak Current	Maximum current of less than ± 10 % of the varistor voltage change when impulse current (8/20 μ s) is applied twice continuously with an interval of 5 minutes.													
Temperature Coefficient of Varistor Voltage	$\frac{V_{1mA} \text{ at } 85 \text{ }^\circ\text{C} - V_{1mA} \text{ at } 25 \text{ }^\circ\text{C}}{V_{1mA} \text{ at } 25 \text{ }^\circ\text{C}} \times \frac{1}{60} \times 100(\%/^\circ\text{C})$		0 to -0.05 %/°C											
Impulse Life (I)	<p>The change of V_c shall be measured after the specified impulse is applied 10000 times continuously with an interval of 10 seconds at room temperature.</p> <table border="1"> <thead> <tr> <th>Part No.</th> <th>Waveform</th> <th>Current</th> </tr> </thead> <tbody> <tr> <td>ERZVF□M220 to ERZVF□M680</td> <td>8/20 μs</td> <td>18 A</td> </tr> <tr> <td>ERZVF□M820 to ERZVF□M271</td> <td>8/20 μs</td> <td>50 A</td> </tr> <tr> <td>ERZVF□M331 to ERZVF□M471</td> <td>8/20 μs</td> <td>30 A</td> </tr> </tbody> </table>	Part No.	Waveform	Current	ERZVF□M220 to ERZVF□M680	8/20 μ s	18 A	ERZVF□M820 to ERZVF□M271	8/20 μ s	50 A	ERZVF□M331 to ERZVF□M471	8/20 μ s	30 A	$\Delta V_{1mA}/V_{1mA} \leq \pm 10$ %
Part No.	Waveform	Current												
ERZVF□M220 to ERZVF□M680	8/20 μ s	18 A												
ERZVF□M820 to ERZVF□M271	8/20 μ s	50 A												
ERZVF□M331 to ERZVF□M471	8/20 μ s	30 A												
Impulse Life (II)	<p>The change of V_c shall be measured after the specified impulse is applied 100000 times continuously with an interval of 10 seconds at room temperature.</p> <table border="1"> <thead> <tr> <th>Part No.</th> <th>Waveform</th> <th>Current</th> </tr> </thead> <tbody> <tr> <td>ERZVF□M220 to ERZVF□M680</td> <td>8/20 μs</td> <td>12 A</td> </tr> <tr> <td>ERZVF□M820 to ERZVF□M271</td> <td>8/20 μs</td> <td>35 A</td> </tr> <tr> <td>ERZVF□M331 to ERZVF□M471</td> <td>8/20 μs</td> <td>20 A</td> </tr> </tbody> </table>	Part No.	Waveform	Current	ERZVF□M220 to ERZVF□M680	8/20 μ s	12 A	ERZVF□M820 to ERZVF□M271	8/20 μ s	35 A	ERZVF□M331 to ERZVF□M471	8/20 μ s	20 A	$\Delta V_{1mA}/V_{1mA} \leq \pm 10$ %
Part No.	Waveform	Current												
ERZVF□M220 to ERZVF□M680	8/20 μ s	12 A												
ERZVF□M820 to ERZVF□M271	8/20 μ s	35 A												
ERZVF□M331 to ERZVF□M471	8/20 μ s	20 A												

Recommendation Land Size

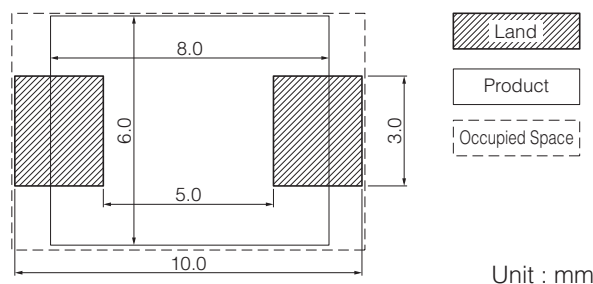

Guidelines and precautions regarding the technical information and use of our products described in this online catalog.

- If you want to use our products described in this online catalog for applications requiring special qualities or reliability, or for applications where the failure or malfunction of the products may directly jeopardize human life or potentially cause personal injury (e.g. aircraft and aerospace equipment, traffic and transportation equipment, combustion equipment, medical equipment, accident prevention, anti-crime equipment, and/or safety equipment), it is necessary to verify whether the specifications of our products fit to such applications. Please ensure that you will ask and check with our inquiry desk as to whether the specifications of our products fit to such applications use before you use our products.
- The quality and performance of our products as described in this online catalog only apply to our products when used in isolation. Therefore, please ensure you evaluate and verify our products under the specific circumstances in which our products are assembled in your own products and in which our products will actually be used.
- If you use our products in equipment that requires a high degree of reliability, regardless of the application, it is recommended that you set up protection circuits and redundancy circuits in order to ensure safety of your equipment.
- The products and product specifications described in this online catalog are subject to change for improvement without prior notice. Therefore, please be sure to request and confirm the latest product specifications which explain the specifications of our products in detail, before you finalize the design of your applications, purchase, or use our products.
- The technical information in this online catalog provides examples of our products' typical operations and application circuits. We do not guarantee the non-infringement of third party's intellectual property rights and we do not grant any license, right, or interest in our intellectual property.
- If any of our products, product specifications and/or technical information in this online catalog is to be exported or provided to non-residents, the laws and regulations of the exporting country, especially with regard to security and export control, shall be observed.

<Regarding the Certificate of Compliance with the EU RoHS Directive/REACH Regulations>

- The switchover date for compliance with the RoHS Directive/REACH Regulations varies depending on the part number or series of our products.
- When you use the inventory of our products for which it is unclear whether those products are compliant with the RoHS Directive/REACH Regulation, please select "Sales Inquiry" in the website inquiry form and contact us.

We do not take any responsibility for the use of our products outside the scope of the specifications, descriptions, guidelines and precautions described in this online catalog.

"ZNR" Transient/Surge Absorbers, Type D, Series V

"ZNR" Transient/Surge Absorbers, Type SMD, Series HF, VF

Handling Precautions

Safety Precautions

In case that a ZNR Surge Absorber (hereafter referred to as the ZNR, or product name) is used, if an abnormality takes place because of peripheral conditions of the ZNR(material, environments, power source conditions, circuit conditions, etc. in equipment design), fire, electric shock, burn, or product failure may be occur. The precautions for this product are described below, understand the content thoroughly before usage. For more questions, contact us.

If there's any uncertainty/doubt/products safety items, please contact us. When a dogma shall be occurred about safety for this products, be sure to inform us rapidly, operate your technical examination.

1. Precautions to be strictly observed

1.1 Confirmation of performance ratings

Use the ZNR within its rated range of performance such as the Max. allowable voltage, withstanding surge current, withstanding energy, impulse life(surge life), average pulse power, and operating temperature range. If used outside the range, the ZNR can be degrade and have element fracture, which may result in smoking and ignition.

1.2 To avoid accidents due to unexpected phenomena, take the following measures

- 1) In the event of fracture of the ZNR, its pieces may scatter ; hence, put the case or cover of the set product in place.
- 2) Do not install the ZNR near combustible substances(polyvinyl chloride wires, resin moldings, etc.).
If it is difficult to do, install a nonflammable cover.
- 3) Across-the-line use
When the ZNR is used across a line, put a current fuse in series with the ZNR(Refer to Item 2.1.1). (4) .
- 4) Use between line to ground
 - (1) If the case that the ZNR is used between a line to the ground, the short-circuit of the ZNR may not blow the current fuse because of grounding resistance, which may cause smoking and ignition of the ZNR's exterior resin.
As the measure against it, install an earth leakage breaker on the power supply side of the ZNR position. If no earth leakage breaker is installed, use a thermal fuse together with a current fuse in series. (Refer to Table 1.)
 - (2) If the case that the ZNR is used between a live part to metal case, an electric shock may develop at a shortcircuit of the ZNR ; hence, ground the metal case to the ground or keep it from the human body.

1.3 If ZNR is shorted out and happen smoke or ignition, please cut provided current to ZNR immediately.

2. Application notes

2.1 Pay attention to the following items to avoid the shortened life and failure of the ZNR

- 1) Circuit conditions
 - (1) Select a ZNR of which the maximum voltage including fluctuations in source voltage allows for the maximum permissible circuit voltage. (Refer to Table 1.)
 - (2) In cases that surges are intermittently applied at short intervals(for example, in case that the voltage of the noise simulator test is implemented etc.), do not let them exceed the ZNR's rated power.
 - (3) Select a ZNR recommended in Table 1.
 - <1> Across-the-line use
If possible, use a Part No. marked with * in case of voltage temporarily rises load unbalance of separately-wired loads, short between hot and neutral-line, open of neutral line in single-phase-three-wired system, and due to resonance at switching for a capacitive, inductive load.

<2> Used between line to ground

Use a different Part No. from "Across-the-line use" as table 1, because of raising voltage in case of "Line to Ground Fault".

Use a Part No. marked with ** in table 1, in case of the insulation resistance test(500 VDC) for equipment. When using a Part of the varistor voltage that the insulation efficiency examination can not be cleared, there is a case where the surge absorber can be done by removing it from the circuit depending on the circuit condition(Refer examination of Japan Domestic Safety Regulations).

Use a Part No. marked with *** in table 1, in case of the withstanding voltage test (1000 VAC or 1200 VAC) for equipment.

(4) Concerning current fuse

<1> We recommend selecting a ZNR and the rated current of a current fuse as follows.

Finally, please be sure that there is no danger if the ZNR mounted on the equipment breaks.

●Type D, Series V

Standard Part No.	ERZV05D□□□	ERZV07D□□□	ERZV09D□□□	ERZV10D□□□	ERZV14D□□□	ERZV20D□□□
Fuse rated current	3 A max.	5 A max.	7 A max.	7 A max.	10 A max.	10 A max.

◆ Fuses shall use rated voltages appropriate for circuits.

●Type SMD, Series VF

Standard Part No.	ERZVF□M□□□
Fuse rated current	5 A max.

◆ Fuses shall use rated voltages appropriate for circuits.

◆ Concerning HF series, please confirm adjusted to load dump surge and protection cooperation.

<2> The recommended fuse position is shown in table 1, "Example of ZNR application", however, if the load current of protected equipment is larger than that of the above recommended fuse rated current, install a current fuse at the position shown below.

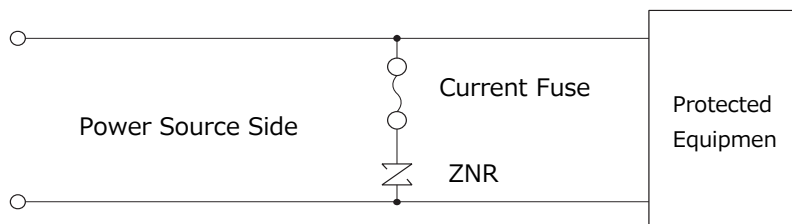

(5) Concerning thermal fuse

Set a thermal fuse to get high thermal

Table 1 Example of ZNR application

		Across-the-Line use	Use between Line to ground																																																						
Connections example	DC/AC Single-phase																																																								
	AC 3-phase																																																								
Example of varistor voltage	ZNR	<table border="1"> <thead> <tr> <th rowspan="2">Source voltage</th> <th colspan="2">Nominal varistor voltage</th> </tr> <tr> <th>Type D</th> <th>SMD Mold Type</th> </tr> </thead> <tbody> <tr> <td rowspan="2">AC 100 V</td> <td>201 to 361*</td> <td>201 to 361*</td> </tr> <tr> <td>241 to 431*</td> <td>241 to 431*</td> </tr> <tr> <td>AC 200 V</td> <td>471 to 621*</td> <td>471</td> </tr> <tr> <td rowspan="2">AC 220 V</td> <td>471 to 621*</td> <td>471</td> </tr> <tr> <td>511, 621*</td> <td>-</td> </tr> <tr> <td>AC 380 V</td> <td>821</td> <td>-</td> </tr> </tbody> </table>	Source voltage	Nominal varistor voltage		Type D	SMD Mold Type	AC 100 V	201 to 361*	201 to 361*	241 to 431*	241 to 431*	AC 200 V	471 to 621*	471	AC 220 V	471 to 621*	471	511, 621*	-	AC 380 V	821	-	<table border="1"> <thead> <tr> <th rowspan="2">Source voltage</th> <th colspan="2">Nominal varistor voltage</th> </tr> <tr> <th>Type D</th> <th>SMD Mold Type</th> </tr> </thead> <tbody> <tr> <td rowspan="2">AC 100 V</td> <td>471</td> <td>471</td> </tr> <tr> <td>511</td> <td>-</td> </tr> <tr> <td rowspan="2">AC 220 V</td> <td>621*</td> <td>-</td> </tr> <tr> <td>821 and more**</td> <td>-</td> </tr> <tr> <td rowspan="2">ZNR 2</td> <td>182***</td> <td>-</td> </tr> <tr> <td>511</td> <td>-</td> </tr> <tr> <td rowspan="2">ZNR 4</td> <td>621*</td> <td>-</td> </tr> <tr> <td>821 and more**</td> <td>-</td> </tr> <tr> <td rowspan="2">AC 240 V</td> <td>182***</td> <td>-</td> </tr> <tr> <td>112**</td> <td>-</td> </tr> <tr> <td>AC 380 V</td> <td>182***</td> <td>-</td> </tr> </tbody> </table>	Source voltage	Nominal varistor voltage		Type D	SMD Mold Type	AC 100 V	471	471	511	-	AC 220 V	621*	-	821 and more**	-	ZNR 2	182***	-	511	-	ZNR 4	621*	-	821 and more**	-	AC 240 V	182***	-	112**	-	AC 380 V	182***	-
	Source voltage	Nominal varistor voltage																																																							
Type D		SMD Mold Type																																																							
AC 100 V	201 to 361*	201 to 361*																																																							
	241 to 431*	241 to 431*																																																							
AC 200 V	471 to 621*	471																																																							
AC 220 V	471 to 621*	471																																																							
	511, 621*	-																																																							
AC 380 V	821	-																																																							
Source voltage	Nominal varistor voltage																																																								
	Type D	SMD Mold Type																																																							
AC 100 V	471	471																																																							
	511	-																																																							
AC 220 V	621*	-																																																							
	821 and more**	-																																																							
ZNR 2	182***	-																																																							
	511	-																																																							
ZNR 4	621*	-																																																							
	821 and more**	-																																																							
AC 240 V	182***	-																																																							
	112**	-																																																							
AC 380 V	182***	-																																																							
Note : Element size is selected by impulse Condition.																																																									

(6) On use for equipment

The catalog guarantees the quality as individual component.

Before you use the products, please make sure to check and evaluate the products in the circumstance where they are installed in your product.

2) Operating environments

- (1) The ZNR is designed to be used indoors. Do not use it exposed outdoors.
- (2) Do not use the ZNR in places exposed to temperatures beyond the operating temperature range, such as places exposed to sunlight and vicinities of heating equipment.
- (3) Do not use the ZNR in places exposed to high temperatures and high humidity, such as places exposed directly to rain, wind, dew condensation, and vapor.
- (4) Do not use the ZNR in dusty and salinity environment and atmospheres polluted by corrosive gases, in liquids such as water, oil, chemical, organic solvent.

3) Processing conditions

- (1) Do not wash the ZNR by such solvents(thinner, acetone, etc.) as its exterior resin deteriorates.
- (2) Do not apply a strong vibration or shock (by falling, etc.) to the ZNR, cracking to its exterior resin and element may occur.
- (3) When coating the ZNR with resin(including molding), do not use such resin.
- (4) Do not bend the ZNR type D lead wires at the position close to its ZNR type D exterior resin, or apply external force to the position.
- (5) When soldering the ZNR lead wires, follow the recommended conditions and do not melt the solder and insulating materials constituting the ZNR.

	Soldering Method	Recommended Condition	Attention Item
Type D	Flow soldering	260 °C, within 10 seconds.	Type D is not Reflow soldering object part.
SMD Type	Flow soldering	260 °C, within 10 seconds.	When the package density of the part is high pill out gas because the solderability sometimes becomes bad.
	Reflow soldering	Refer to Reflow soldering profile	When Land is too big compared with the size of the terminal surface of the part, be careful because the part sometimes upset when solder fuses.

- * 1 Soldering iron temperature should not exceed 400 °C and should not be applied for more than 5 seconds.
- * 2 Profile be careful because there is a margin of error in the way of measuring.
- * 3 The temperature depends on the size and the package density of the substrate. Therefore, confirm every kind of the substrate.

● Soldering temperature-time profile to recommend

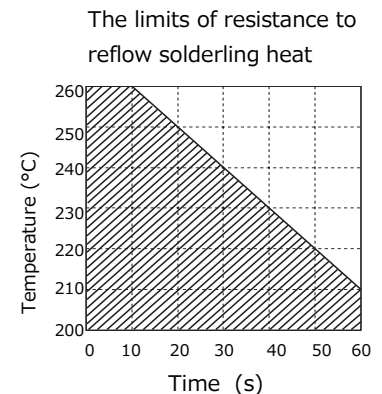
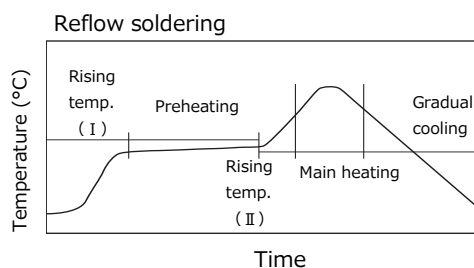
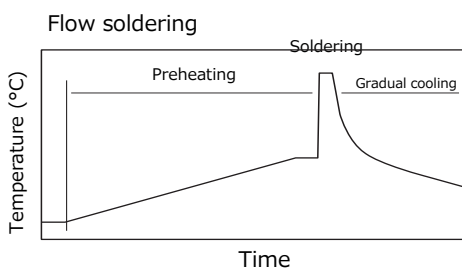

Preheating	The normal to 130 °C	max. 120 s
Soldering	max. 260 °C	max. 10 s
Gradual cooling	Gradual cooling	

Rising temperature I	The normal to preheating temperature	30 to 60 s
Preheating	150 °C to 180 °C	60 to 120 s
Rising temperature II	Preheating to 200 °C	2 to 6 °C / s
Main heating	(cf. The limit of resistance to reflow soldering heat)	
Gradual cooling	200 °C to 100 °C	1 to 4 °C / s

(Reflow soldering shall be within two times)

(6) Lead-wire terminal land-hole (only for Type D)

When designing lead-wire-terminal land-hole of circuit board, please check actual ZNR by reference specification about center value of lead-wire terminal pitch.

(7) Mounting (only for Type SMD)

In case of mounting ZNR on a Printed Circuit Board, be careful not to put excessive impact load, such as pressure from adsorption nozzle, and mechanical impact/stress of position-shifting or positioning. Also, we recommend you to fix a Printed Circuit Board to sheathing resin with an adhesive in case of position-shifting of ZNR when mounting.

4) Long-term storage

- (1) Do not store the ZNR under high temperature and high humidity. Store it indoor environment at a temperature up to 40 °C and at humidity below 75 %RH, and use it within two years. Before using the ZNR that has been stored for a long period (two years or longer), confirm the solderability.
- (2) Avoid atmospheres full of corrosive gases (hydrogen sulfide, sulfurous acid, chlorine, ammonia, etc.).
- (3) Avoid direct sunlight and dew condensation.

5) Rated Voltage for UL or other safety certifications

Our ZNR define "Max. Allowable Voltage" and "Rated Voltage" to keep leakage current specification and others. If you getting certificate of safety approval about your equipment with our ZNR, please follow our "Rated Voltage".

6) Dropped product

Do not drop this product on the floor. If this product is dropped, it can be damaged mechanically or electrically. Avoid using the dropped product.

3. Notices

- 3.1 Our ZNR was designed and manufactured for standard applications such as general electronics devices, office equipment, information and communications equipment, measuring instruments, household appliances and audio-video equipment. For applications in which special quality and reliability are required, or if the failure or malfunction of the products may directly jeopardize life or cause threat of personal injury (such as for aircraft and aerospace equipment, traffic and transport equipment, combustion equipment, medical equipment, accident prevention and anti-theft devices, and safety equipment), please be sure to consult with our sales representative in advance and to exchange product specifications which conform to such applications. applications in which special quality and reliability are required, or if the failure or malfunction of the products may.
- 3.2 Note that we do not take any responsibility for faults and abnormalities resulting from the use not in conformity with the contents of entries in the delivery specification.
- 3.3 There is a possibility that the ZNR will unexpectedly cause smoke or ignite because of an abnormal rise of the circuit voltage and invasion of excessive surge. To prevent that accident from spreading over the equipment and not to expand the damage, use multiplex protection such as the adoption of flame-retardant materials for housing parts and structural parts.

4. Applicable laws and regulations , others

- 4.1 This product not been manufactured with any ozone depleting chemical controlled under the Montreal Protocol.
- 4.2 This product comply with RoHS(Restriction of the use of certain Hazardous Substance in electrical and electronic equipment) (DIRECTIVE 2011/65/EU and (EU)2015/863).
- 4.3 All the materials used in this part are registered material under the Law Concerning the Examination and Regulation of Manufacture, etc. of Chemical Substance.
- 4.4 If you need the notice by letter of "A preliminary judgement on the Laws of Japan foreign exchange and Foreign Trade Control", be sure to let us know.
- 4.5 These products are not dangerous goods on the transportation as identified by UN(United nations) numbers or UN classification.

5. Others

- 5.1 As to the disposal of ZNR, check the method of disposal in each country or origin where the ZNR are incorporated in your products to be used.
- 5.2 The technical information in this specification provides example of our products' typical operations and application circuit. We do not guarantee the non-infringement of third party's intellectual property rights and we do not grant any license, right or interest in our intellectual property.

Mouser Electronics

Authorized Distributor

Click to View Pricing, Inventory, Delivery & Lifecycle Information:

Panasonic:

[ERZ-VF2M220](#) [ERZ-VF2M271](#) [ERZ-VF2M820](#) [ERZ-VF2M390](#) [ERZ-VF2M241](#) [ERZ-VF2M101](#) [ERZ-VF2M121](#)
[ERZ-VF2M151](#) [ERZ-VF2M201](#) [ERZ-VF2M221](#) [ERZ-VF2M270](#) [ERZ-VF2M330](#) [ERZ-VF2M331](#) [ERZ-VF2M361](#) [ERZ-](#)
[VF2M391](#) [ERZ-VF2M431](#) [ERZ-VF2M470](#) [ERZ-VF2M471](#) [ERZ-VF2M560](#) [ERZ-VF2M680](#)



Компания «ЭлектроПласт» предлагает заключение долгосрочных отношений при поставках импортных электронных компонентов на взаимовыгодных условиях!

Наши преимущества:

- Оперативные поставки широкого спектра электронных компонентов отечественного и импортного производства напрямую от производителей и с крупнейших мировых складов;
- Поставка более 17-ти миллионов наименований электронных компонентов;
- Поставка сложных, дефицитных, либо снятых с производства позиций;
- Оперативные сроки поставки под заказ (от 5 рабочих дней);
- Экспресс доставка в любую точку России;
- Техническая поддержка проекта, помощь в подборе аналогов, поставка прототипов;
- Система менеджмента качества сертифицирована по Международному стандарту ISO 9001;
- Лицензия ФСБ на осуществление работ с использованием сведений, составляющих государственную тайну;
- Поставка специализированных компонентов (Xilinx, Altera, Analog Devices, Intersil, Interpoint, Microsemi, Aeroflex, Peregrine, Syfer, Eurofarad, Texas Instrument, Miteq, Cobham, E2V, MA-COM, Hittite, Mini-Circuits, General Dynamics и др.);

Помимо этого, одним из направлений компании «ЭлектроПласт» является направление «Источники питания». Мы предлагаем Вам помощь Конструкторского отдела:

- Подбор оптимального решения, техническое обоснование при выборе компонента;
- Подбор аналогов;
- Консультации по применению компонента;
- Поставка образцов и прототипов;
- Техническая поддержка проекта;
- Защита от снятия компонента с производства.



Как с нами связаться

Телефон: 8 (812) 309 58 32 (многоканальный)

Факс: 8 (812) 320-02-42

Электронная почта: org@eplast1.ru

Адрес: 198099, г. Санкт-Петербург, ул. Калинина, дом 2, корпус 4, литера А.