

A3A

Lighted Pushbutton Switch

Compact High-capacity Push-button Switch

- Ideal for use as a high breaking capacity Power Switch.
- Switches from micro load (minimum applicable load: 5 VDC 1mA) to high capacity load.

RoHS Compliant

⚠ Refer to Safety Precautions for All Pushbutton Switches and Safety Precautions on page 8.



List of Models

● Non-lighted Push-button Switches

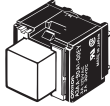
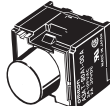
Appearance	Model
Square 	A3AA-9□ □1-00□
Round 	A3AT-9□ □1-00□

● Lighted Push-button Switches

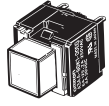
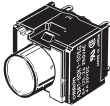
Illumination	Appearance	Model
LED surface illumination	Square 	A3AA-9□ □1-00E□
	Round 	A3AT-9□ □1-00E□

Model Number Structure

■ Model Number Legend (Ordering as a Set).....

The model numbers used to order sets of Units are illustrated below. One set comprises the Pushbutton (LED lamp built-in) and Switch. For information on combinations, refer to Ordering Information.

A 3 A **A** - **9** **0** **K** **1** - **00E** **R**

(1) Shape of Pushbutton

Symbol	Shape
A	Square
T	Round

(2) Terminal

Symbol	Type
0	Solder
1	PCB

(3) Switch Specifications

Symbol	Operation	Contact type	
A	Momentary	SPDT	(3 A at 125 VAC, 2 A at 30 VDC)
B	Alternate		
K	Momentary	SPST-NO	(6 A at 125 VAC, 2 A at 250 VAC, 4 A at 30 VDC)
L	Alternate		

(4) Illumination

Symbol	Operation
00	Non-lighted
00E	Surface illumination

(5) Color

1. Pushbutton (Non-lighted Models)

Symbol	Color
L	Light gray
R	Red*
Y	Yellow*
G	Green*
A	Blue
B	Black
D	Dark gray
H	Gray

2. LED (Surface Illumination Models)

Symbol	Color
R	Red
Y	Yellow
G	Green

* Common to both lighted and non-lighted models.

■ Specifications: Refer to page 3.

■ Accessories: Refer to page 2.

■ Dimensions: Refer to page 5.

List of Models

SPST-NO

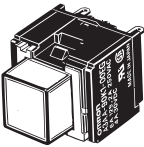
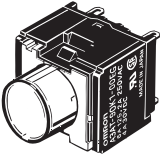
Appearance	Terminal	Operation	Illumination	Model	Color symbol for pushbutton	Minimum packing unit
Square/A3AA 	Solder	Momentary	Non-lighted	A3AA-90K1-00 □	(Non-lighted) R (red) Y (yellow) G (green) L (light gray) A (blue) B (black) D (dark gray) H (gray) (Surface illumination) R (red) Y (yellow) G (green)	100
			LED surface illumination	A3AA-90K1-00E □		
		Alternate	Non-lighted	A3AA-90L1-00 □		
			LED surface illumination	A3AA-90L1-00E □		
	PCB	Momentary	Non-lighted	A3AA-91K1-00 □		
			LED surface illumination	A3AA-91K1-00E □		
		Alternate	Non-lighted	A3AA-91L1-00 □		
			LED surface illumination	A3AA-91L1-00E □		
Round/A3AT 	Solder	Momentary	Non-lighted	A3AT-90K1-00 □		
			LED surface illumination	A3AT-90K1-00E □		
		Alternate	Non-lighted	A3AT-90L1-00 □		
			LED surface illumination	A3AT-90L1-00E □		
	PCB	Momentary	Non-lighted	A3AT-91K1-00 □		
			LED surface illumination	A3AT-91K1-00E □		
		Alternate	Non-lighted	A3AT-91L1-00 □		
			LED surface illumination	A3AT-91L1-00E □		



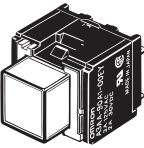
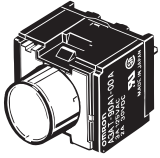

Note: The above models each have a SPST-NO contact that can switch 6 A at 125 VAC, 2 A at 250 VAC, and 4 A at 30 VDC. When ordering any of the above models, replace □ of the model number with a code to indicate the pushbutton color of the model (i.e., replace □ with R, Y, G, L, A, B, D, H, and L). The pushbutton of an A3A does not illuminate if the color of the pushbutton is dark gray, gray, light gray, blue, or black.

SPDT

Appearance	Terminal	Operation	Illumination	Model	Color symbol for pushbutton	Minimum packing unit
Square/A3AA 	Solder	Momentary	Non-lighted	A3AA-90A1-00 □	(Non-lighted) R (red) Y (yellow) G (green) L (light gray) A (blue) B (black) D (dark gray) H (gray) (Surface illumination) R (red) Y (yellow) G (green)	100
			LED surface illumination	A3AA-90A1-00E □		
		Alternate	Non-lighted	A3AA-90B1-00 □		
			LED surface illumination	A3AA-90B1-00E □		
	PCB	Momentary	Non-lighted	A3AA-91A1-00 □		
			LED surface illumination	A3AA-91A1-00E □		
		Alternate	Non-lighted	A3AA-91B1-00 □		
			LED surface illumination	A3AA-91B1-00E □		
Round/A3AT 	Solder	Momentary	Non-lighted	A3AT-90A1-00 □		
			LED surface illumination	A3AT-90A1-00E □		
		Alternate	Non-lighted	A3AT-90B1-00 □		
			LED surface illumination	A3AT-90B1-00E □		
	PCB	Momentary	Non-lighted	A3AT-91A1-00 □		
			LED surface illumination	A3AT-91A1-00E □		
		Alternate	Non-lighted	A3AT-91B1-00 □		
			LED surface illumination	A3AT-91B1-00E □		

Accessories

Flange (Select according to panel color.)

Name	Shape	Classification	Model	Minimum packing unit			
Flange	Square □12.7 	Flange alone	Black	A3A-241	100		
			Light gray	A3A-242			
			Black	A3A-251			
			Light gray	A3A-252			
	Round φ12.7 	Leaf spring		A3A-200			
			Square □12.7 	Flange and leaf spring (one each)		Black	A3A-211
						Light gray	A3A-212
						Black	A3A-221
Light gray	A3A-222						
Round φ12.7 							

Note: An A3A with solder terminals is provided with a round or square black flange and leaf spring. A round black flange is provided with each A3A having solder terminals and a round pushbutton. A square black flange is provided with each A3A having solder terminals and a square pushbutton.

Specifications

Approved Standards

UL CSA	}	• SPST-NO	• SPDT
		6 A at 125 VAC	3 A at 125 VAC
		2 A at 250 VAC	2 A at 30 VDC
		4 A at 30 VDC	

Ratings

Type	Item Contact form	AC resistive load	DC resistive load
General load	SPST-NO	6 A at 125 VAC 2 A at 250 VAC	4 A at 30 VDC

Note: Minimum allowable load: 5 VDC 1 mA (Resistive)
 The ratings given above are for testing under the following conditions:
 (1) Ambient temperature: 20 ±2°C
 (2) Ambient humidity: 65 ±5%
 (3) Operating frequency: 20 times/minute

LED

Item	Illumination	Surface illumination		
		Red	Yellow	Green
Forward voltage V_F	Standard value (V) * ($I_F = 10$ mA)	2.0	2.1	2.1
	Maximum value (V)	3.0		
Forward current I_F	Maximum value (mA)	20	20	25
Permissible loss PD	Maximum value (mW)	60	60	75
Reverse voltage V_R	Maximum value (V)	3		

Note: The above built-in LEDs do not have a resistor. Connect to each of the above built-in LEDs a resistor that satisfies the above conditions.
 * Refer to the $V_F - I_F$ characteristic graphs on page 8.

Operating Characteristics

Operating force	OF max.	2.45 N
Release force	RF min.	0.15 N
Total travel	TT	Approx. 2mm
Pretravel	PT max.	1.5 mm
Locktravel alternate *	LTA min.	0.5 mm

* Alternate operation models only.

Characteristics

Operating frequency	Mechanical	Momentary action: 120 operations/minute max. Alternate action: 60 operations/minute max. *1
	Electrical	20 operations/minute max.
Insulation resistance		100 MΩ min. (at 500 VDC)
Contact resistance		100 mΩ max. (initial value)
Dielectric strength	Between terminals of same polarity	600 VAC, 50/60 Hz for 1 min
	Between each terminal and ground	2,000 VAC, 50/60 Hz for 1 min
Vibration resistance	Malfunction	10 to 55 Hz, 1.5-mm double amplitude *2
Shock resistance	Destruction	500 m/s ²
	Malfunction	150 m/s ² *2
Durability	Mechanical	Momentary action: 1,000,000 operations min. Alternate action: 50,000 operations min. *1
	Electrical	50,000 operations min.
Weight		Approx. 3.2 g
Ambient operating temperature		-10°C to +55°C (with no icing)
Ambient operating humidity		35% to 85%
Ambient storage temperature		-25°C to +65°C (with no icing)
Degree of protection		IP00
Electric shock protection class		Class II
PTI (proof tracking index)		175
Pollution degree		3 (IEC947-5-1)

*1. With alternate operation models, one operation cycle consists of set and reset operations.
 *2. Indicates malfunctions of less than 1 ms.

Contact Form

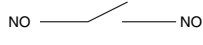
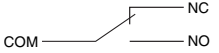
Contact name	Contact form	Contact type
Double-break	SPST-NO	NO 
Double-throw	SPDT	COM 

Nomenclature

Model Structure

<Pushbutton>

1. Shape
Square
(A3AA)



Round
(A3AT)



Diffusion sheet
(milky white)

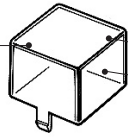

4. Color cap

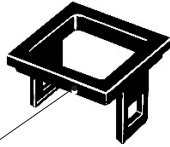

Flange

5. Color

• Non-lighted Model

Red, yellow, light gray,

gray, dark gray,

green, blue, black

• Surface Illumination Model

Red, yellow, green

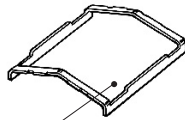

Leaf spring

<Switch>

3. Ratings

Standard load

6 A at 125 VAC

2 A at 250 VAC

4 A at 30 VDC

* Minimum applicable load:

1 mA at 5 VDC (resistive load)

2. Terminals

• Solder terminal

• PCB terminal

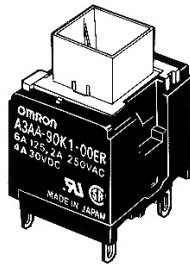

Note 1. The above is for the A3AA.

2. An A3A with solder terminals is provided with a black flange and leaf spring, however an A3A with PCB terminals is not provided with them. If a black flange and leaf spring are required for an A3A with PCB terminals, order them from your OMRON representative. (Refer to page 2.)

Dimensions

(Unit: mm)

Non-lighted Model Square Pushbutton

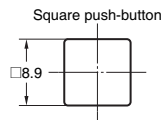
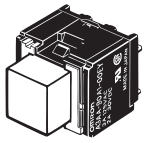

SPST-NO

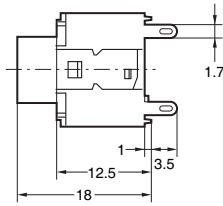

SPDT

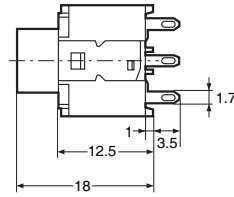

Round Pushbutton

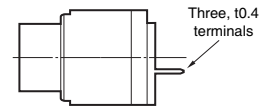
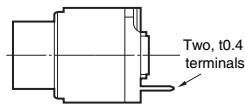
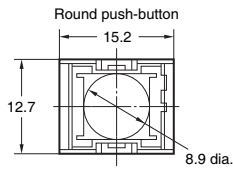
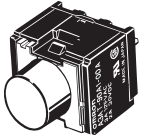

Surface Illumination Model Square Pushbutton

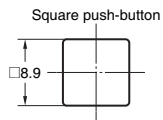
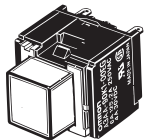

SPST-NO

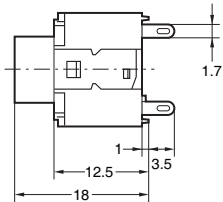

SPDT

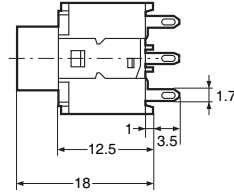

Round Pushbutton

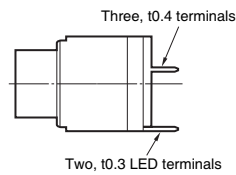
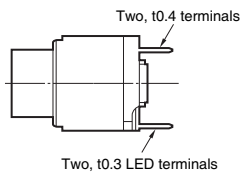
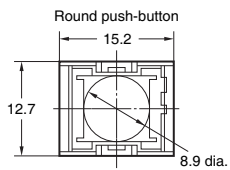
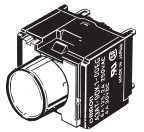

Note: All units are in millimeters unless otherwise indicated.

The illustrations below show switches with solder terminals, without a flange or leaf spring. Unless specified, there is a tolerance of ± 0.4 mm for dimensions.

■ Terminals

Contact	Solder terminal	PCB terminal
SPST-NO	<p>Terminal Hole Dimensions</p> <p>Non-lighted Models Switch terminal: t0.4</p> <p>Lighted Models Switch terminal: t0.4 Lamp terminal: t0.3</p> <p>Terminal Arrangement (BOTTOM VIEW)</p> <p>PCB Dimensions (BOTTOM VIEW)</p>	<p>Non-lighted Models</p> <p>Lighted Models</p> <p>Terminal Arrangement (BOTTOM VIEW)</p> <p>PCB Dimensions (BOTTOM VIEW)</p>
	<p>Terminal Hole Dimensions</p> <p>Non-lighted Models Switch terminal: t0.4</p> <p>Lighted Models Switch terminal: t0.4 Lamp terminal: t0.3</p> <p>Terminal Arrangement (BOTTOM VIEW)</p> <p>PCB Dimensions (BOTTOM VIEW)</p>	<p>Non-lighted Models</p> <p>Lighted Models</p> <p>Terminal Arrangement (BOTTOM VIEW)</p> <p>PCB Dimensions (BOTTOM VIEW)</p>
SPDT	<p>Terminal Hole Dimensions</p> <p>Non-lighted Models Switch terminal: t0.4</p> <p>Lighted Models Switch terminal: t0.4 Lamp terminal: t0.3</p> <p>Terminal Arrangement (BOTTOM VIEW)</p> <p>PCB Dimensions (BOTTOM VIEW)</p>	<p>Non-lighted Models</p> <p>Lighted Models</p> <p>Terminal Arrangement (BOTTOM VIEW)</p> <p>PCB Dimensions (BOTTOM VIEW)</p>

A3A

Accessories Dimensions

Leaf Spring A3A-200

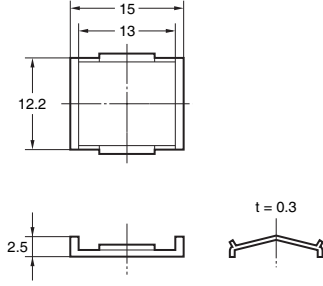

Flange (Square) A3A-24

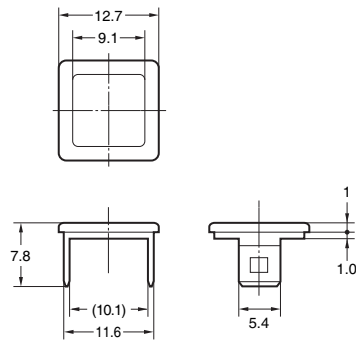

Flange (Round) A3A-25

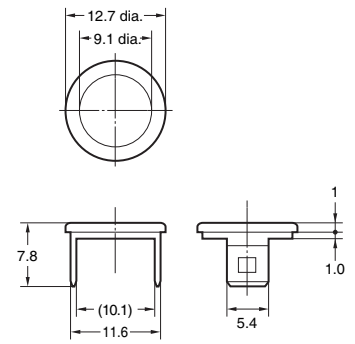

Note: Unless otherwise specified, a tolerance of ± 0.4 mm applies to all dimensions.

Panel Cutouts

Square Pushbutton

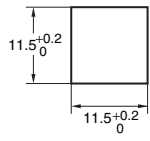

Round Pushbutton

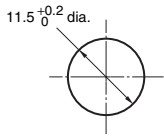

For Side-by-side Mounting

	Square pushbutton	Round pushbutton
Horizontal multiple mounting		
Vertical multiple mounting		

Panel Mounting Dimensions

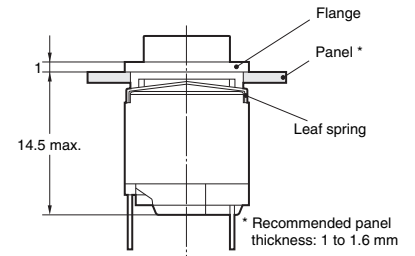

(The diagram shows the lighted SPST-NO model.)

Precautions

● Refer to the “Push-button Switches Common Precautions” for correct use.

Precautions for Correct Use

- Please do not perform wiring or touch the charged parts of terminals while power is supplied to the Switch. Doing so may result in electric shock.
- Make sure to keep a secure insulation distance after wiring to the Switch.

● Mounting

- When opening a hole on a panel to mount an A3A to the panel, make sure that the hole has no burr.
- When mounting a flange to the switching mechanism of an A3A, make sure that the flange and the casing of the switching mechanism are engaged securely.

● Wiring

- When soldering the terminals of an A3A, refer to the following.
 1. For manual soldering:
 - Use a soldering iron with the terminals at a temperature of 350°C maximum within three seconds.
 - 2. Do not impose any external force on the terminals for one minute after the terminals are soldered.
- Do not pull the terminals of any A3A with a force exceeding 5.34 N, otherwise the joint part of the A3A may be damaged.
- When soldering the terminals of an A3A, apply non-corrosive rosin flux to the terminals.
- After soldering the terminals of an A3A, do not wash the A3A with any solvent.
- When mounting an A3A to a PCB and soldering the terminals of the A3A to the PCB, make sure that the flux will not rise above the surface of the PCB.

● Operating Environment

- When using an A3A, make sure that dust, metal powder, or oil will not penetrate into the interior of the A3A.

● LED

- The polarity of the LED is indicated on the back of the Switch. Wire the LED correctly according to the polarity.
- An A3A with a built-in LED does not have a limiting resistor. Connect a limiting resistor.
- The resistance can be calculated by using the following expression.

$$R = \frac{E - V_F}{I_F} (\Omega)$$

E : Applied voltage (V)
 V_F : LED forward voltage (V)
 I_F : LED forward current (A)

Note: Make sure that the limiting resistor connected to the built-in LED of an A3A satisfies the characteristics of the built-in LED. The mean forward current of the built-in LED must be 8 mA minimum.

● Example

Conditions: Red LED with an I_F of 10 mA at 24 V and a T_a of 25°C.
 From the red LED characteristic below, V_F will be 2 V when I_F is 10 mA.
 Therefore, R = (24 V - 2 V)/0.01 A = 2,200 Ω.

Thus the recommended resistance is 2.2 kΩ at 0.5 W (2* x I_F²R).

Note: A factor of 2 (marked with an asterisk) is applied because the permissible wattage of the resistor must be twice as large as the required wattage.

LED Characteristics

(V_F – I_F Characteristics)

T_a: Ambient Temperature

(Red)

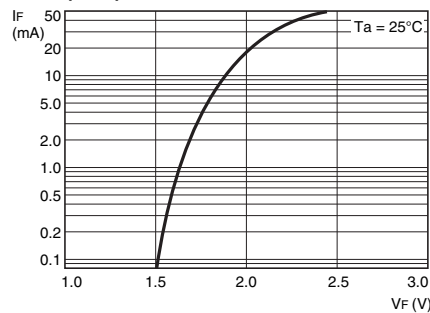

(Yellow)

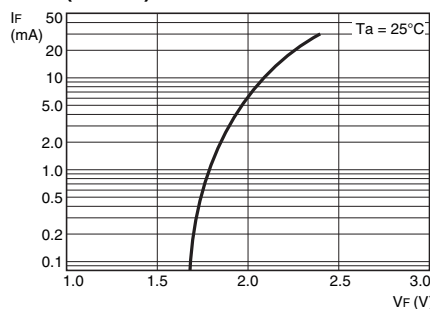

(Green)

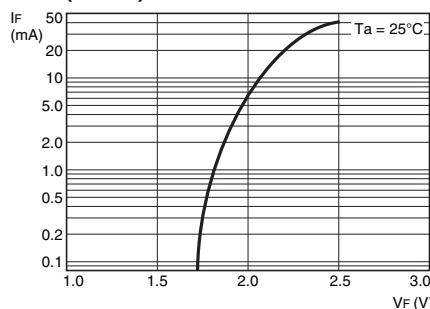

● Pushbutton

- When exchanging the Pushbutton (except the ones for the mechanical indicator models) with a new one, pull out the Pushbutton from the Switch, holding the Pushbutton in the longitudinal direction. Do not remove the Pushbutton of the mechanical indicator model.

● Engraving of Pushbutton

- Depth of engraving: 0.3 mm max. for illuminating pushbutton
- Since the Pushbutton is made of polycarbonate, use an alcohol-based paint when marking legend.

● Pressing of Pushbutton

- Apply firm pressure to the Pushbutton when operating it. In doing so, however, do not apply a pressure greater than 11.8 N.

■ Installation

● Mounting and Replacing the Pushbutton

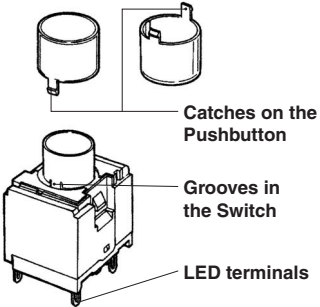
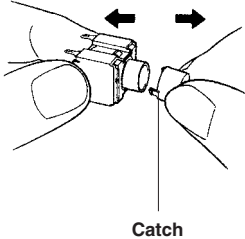
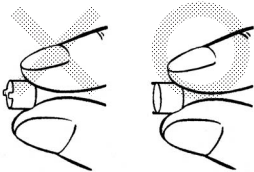
1. Mounting Direction for the Pushbutton and Switch	2. Removing the Pushbutton (Non-lighted Models Only)	
<ul style="list-style-type: none"> Insert the catches of the Pushbutton into the grooves of the Switch and push down on the Pushbutton until it is fixed securely to the Switch. With lighted models, the LED is built into the Switch and cannot be replaced. 	<ul style="list-style-type: none"> To remove the Pushbutton, hold both the Pushbutton and the Switch on the longer sides and pull the Pushbutton away from the Switch. (If the catches on the Pushbutton are bent outwards, it may result in malfunction.) 	<ul style="list-style-type: none"> When replacing the Pushbutton, if the cap is held on the sides with catches, internal components (e.g., plate) may come loose. Be sure to hold the Pushbutton by the sides without catches (i.e., the longer sides of the Switch) when removing. 

● Mounting Switch on a Panel

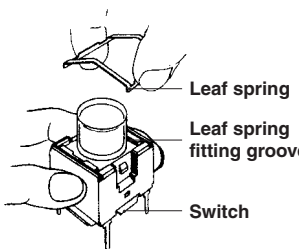
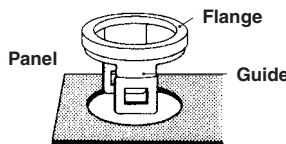
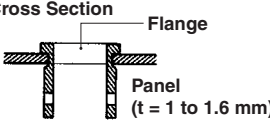
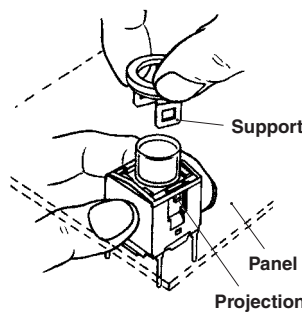
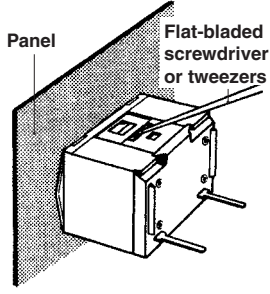
1. Mount Leaf Spring	2. Mount Flange on Panel	3. Fit Flange with Switch	4. Removing Switch
<ul style="list-style-type: none"> Press the leaf spring into the fitted groove on the upper surface of the Switch. For an easier fitting, first fit one side of the leaf spring, then press the other side into the fitting groove. (It will be easier mounting the leaf spring of one side first, then mount the other side.)  <p>Note: Be sure to fit the leaf spring exactly into the groove, and do not allow it to slip out of the groove.</p>	<ul style="list-style-type: none"> Insert the flange from the front surface of the panel.  <ul style="list-style-type: none"> The flange has two opposing guides to facilitate its insertion into the panel cutout hole. Be sure the flange does not remain tilted with respect to the panel surface after being installed.  <p>Note: The mounting direction of the flange determines the orientation of the Switch.</p>	<ul style="list-style-type: none"> While holding the flange, insert the opposing supports into the gaps between the leaf spring and Switch on the longer sides of the housing, and fit the rectangular hole of the flange with the projections of the switch housing.  <p>Note: Completely remove any burrs on the panel cutout surface; otherwise, the flange and Switch will not attach solidly.</p>	<ul style="list-style-type: none"> Insert a small flat-bladed screwdriver or tweezers into the flange support exposed on the rear of the panel. Pry up on each side to pull out the Switch.  <p>Note: Do not pry up the flange support more than necessary or the switch holding portions may be damaged.</p>

• Application examples provided in this document are for reference only. In actual applications, confirm equipment functions and safety before using the product.
• Consult your OMRON representative before using the product under conditions which are not described in the manual or applying the product to nuclear control systems, railroad systems, aviation systems, vehicles, combustion systems, medical equipment, amusement machines, safety equipment, and other systems or equipment that may have a serious influence on lives and property if used improperly. Make sure that the ratings and performance characteristics of the product provide a margin of safety for the system or equipment, and be sure to provide the system or equipment with double safety mechanisms.

Note: Do not use this document to operate the Unit.



Компания «ЭлектроПласт» предлагает заключение долгосрочных отношений при поставках импортных электронных компонентов на взаимовыгодных условиях!

Наши преимущества:

- Оперативные поставки широкого спектра электронных компонентов отечественного и импортного производства напрямую от производителей и с крупнейших мировых складов;
- Поставка более 17-ти миллионов наименований электронных компонентов;
- Поставка сложных, дефицитных, либо снятых с производства позиций;
- Оперативные сроки поставки под заказ (от 5 рабочих дней);
- Экспресс доставка в любую точку России;
- Техническая поддержка проекта, помощь в подборе аналогов, поставка прототипов;
- Система менеджмента качества сертифицирована по Международному стандарту ISO 9001;
- Лицензия ФСБ на осуществление работ с использованием сведений, составляющих государственную тайну;
- Поставка специализированных компонентов (Xilinx, Altera, Analog Devices, Intersil, Interpoint, Microsemi, Aeroflex, Peregrine, Syfer, Eurofarad, Texas Instrument, Miteq, Cobham, E2V, MA-COM, Hittite, Mini-Circuits, General Dynamics и др.);

Помимо этого, одним из направлений компании «ЭлектроПласт» является направление «Источники питания». Мы предлагаем Вам помощь Конструкторского отдела:

- Подбор оптимального решения, техническое обоснование при выборе компонента;
- Подбор аналогов;
- Консультации по применению компонента;
- Поставка образцов и прототипов;
- Техническая поддержка проекта;
- Защита от снятия компонента с производства.



Как с нами связаться

Телефон: 8 (812) 309 58 32 (многоканальный)

Факс: 8 (812) 320-02-42

Электронная почта: org@eplast1.ru

Адрес: 198099, г. Санкт-Петербург, ул. Калинина, дом 2, корпус 4, литера А.