

# EMRE12J2H-156.250M

 <p><b>Lead Free</b> COMPLIANT</p>	 <p><b>EU RoHS</b> 2011/65 + 2015/863 COMPLIANT</p>	 <p><b>China RoHS</b> COMPLIANT</p>	 <p><b>REACH</b> SVHC 163 Jun 15, 2015 COMPLIANT</p>
--	--	--	---



## ITEM DESCRIPTION

MEMS Clock Oscillators LVDS (DS) 2.5Vdc 6 Pad 5.0mm x 7.0mm Plastic Surface Mount (SMD) 156.250MHz  $\pm$ 25ppm over -40°C to +85°C

## ELECTRICAL SPECIFICATIONS

<b>Nominal Frequency</b>	156.250MHz
<b>Frequency Tolerance/Stability</b>	$\pm$ 25ppm Maximum over -40°C to +85°C (Inclusive of all conditions: Calibration Tolerance at 25°C, Frequency Stability over the Operating Temperature Range, Supply Voltage Change, Output Load Change, 1st Year Aging at 25°C, Reflow, Shock, and Vibration)
<b>Aging at 25°C</b>	$\pm$ 1ppm Maximum First Year
<b>Supply Voltage</b>	2.5Vdc $\pm$ 10%
<b>Input Current</b>	45mA Typical, 55mA Maximum (Excluding Load Termination Current)
<b>Differential Output Error (dVod)</b>	50mVdc Maximum
<b>Differential Output Voltage (Vod)</b>	200mVdc Minimum, 350mVdc Typical, 500mVdc Maximum
<b>Offset Voltage (Vos)</b>	1.125V Minimum, 1.20V Typical, 1.375V Maximum
<b>Rise/Fall Time</b>	500pSec Typical, 600pSec Maximum (Measured over 20% to 80% of waveform)
<b>Duty Cycle</b>	50 $\pm$ 5(%) (Measured at 50% of waveform)
<b>Offset Error (dVos)</b>	50mVdc Maximum
<b>Load Drive Capability</b>	100 Ohms Between Output and Complementary Output
<b>Output Logic Type</b>	LVDS
<b>Logic Control / Additional Output</b>	Output Enable (OE) and Complementary Output
<b>Output Control Input Voltage</b>	Vih of 70% of Vdd Minimum or No Connect to Enable Output and Complementary Output, Vil of 30% of Vdd Maximum to Disable Output and Complementary Output (High Impedance)
<b>Output Enable Current</b>	35mA Maximum (OE) Without Load
<b>RMS Phase Jitter</b>	0.5pSec Typical, 1pSec Maximum (Fj = 12kHz to 20MHz; Random)
<b>Period Jitter (Deterministic)</b>	0.2pSec Typical
<b>Period Jitter (Random)</b>	1.0pSec Typical
<b>Period Jitter (RMS)</b>	1.4pSec Typical, 1.7pSec Maximum
<b>Period Jitter (pk-pk)</b>	15pSec Typical, 20pSec Maximum
<b>Start Up Time</b>	10mSec Maximum
<b>Storage Temperature Range</b>	-55°C to +125°C

## ENVIRONMENTAL & MECHANICAL SPECIFICATIONS

<b>ESD Susceptibility</b>	MIL-STD-883, Method 3015, Class 2, HBM 2000V
<b>Flammability</b>	UL94-V0
<b>Mechanical Shock</b>	MIL-STD-883, Method 2002, Condition G, 30,000G
<b>Moisture Resistance</b>	MIL-STD-883, Method 1004
<b>Moisture Sensitivity Level</b>	J-STD-020, MSL 1
<b>Resistance to Soldering Heat</b>	MIL-STD-202, Method 210, Condition K
<b>Resistance to Solvents</b>	MIL-STD-202, Method 215
<b>Solderability</b>	MIL-STD-883, Method 2003 (Six I/O Pads on bottom of package only)
<b>Temperature Cycling</b>	MIL-STD-883, Method 1010, Condition B
<b>Thermal Shock</b>	MIL-STD-883, Method 1011, Condition B
<b>Vibration</b>	MIL-STD-883, Method 2007, Condition A, 20G

# EMRE12J2H-156.250M

## MECHANICAL DIMENSIONS (all dimensions in millimeters)

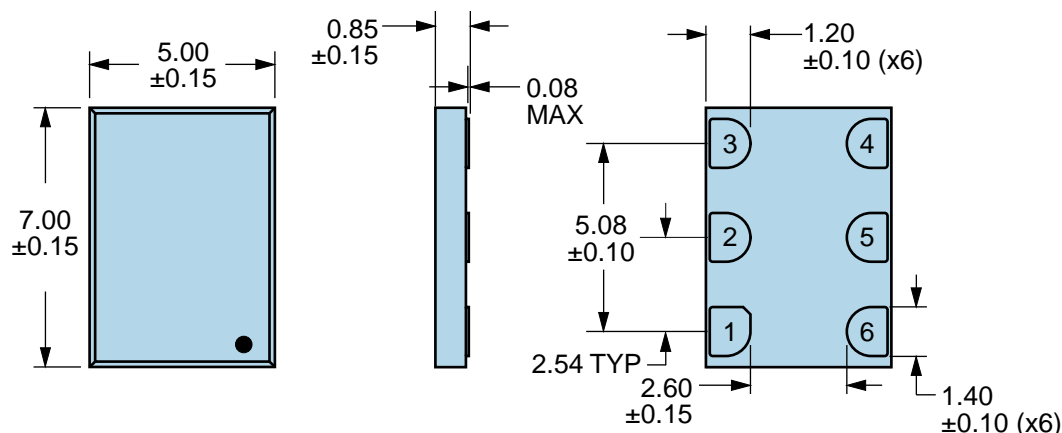

PIN	CONNECTION
1	Output Enable (OE)
2	No Connect
3	Case Ground
4	Output
5	Complementary Output
6	Supply Voltage

LINE	MARKING
1	XXXXXX XXXXXX=Ecliptek Manufacturing Lot Code

## Suggested Solder Pad Layout

All Dimensions in Millimeters

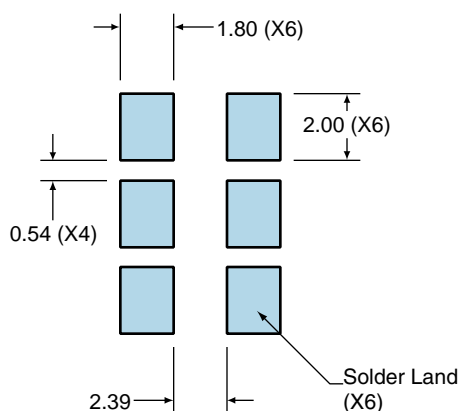

All Tolerances are ±0.1

# EMRE12J2H-156.250M

## OUTPUT WAVEFORM & TIMING DIAGRAM

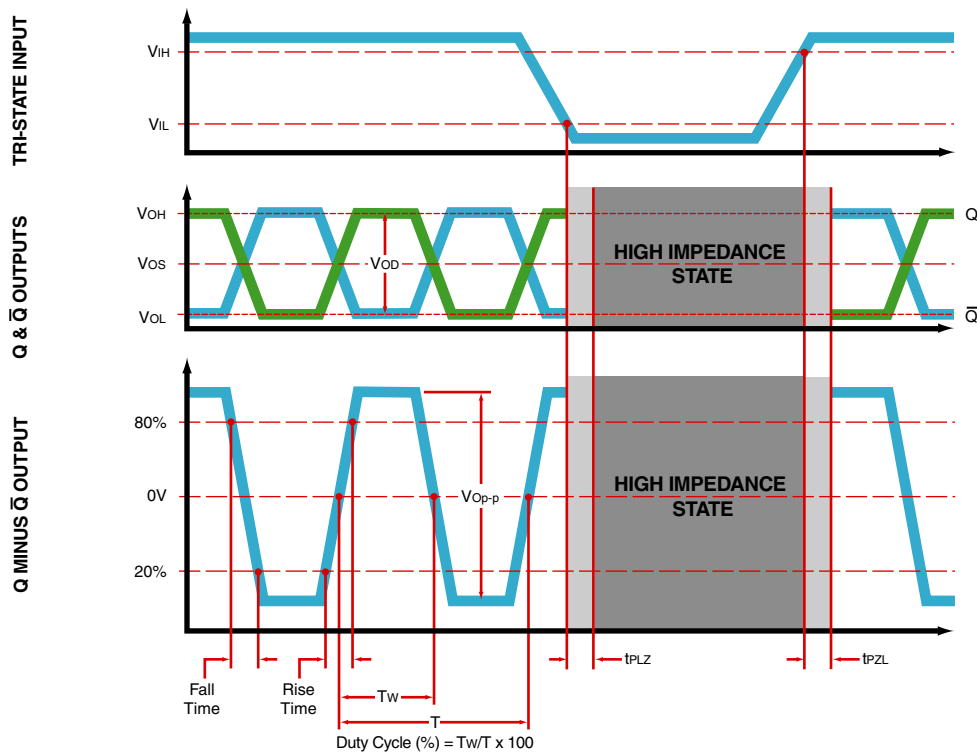

# EMRE12J2H-156.250M

## Test Circuit for Tri-State and Complementary Output

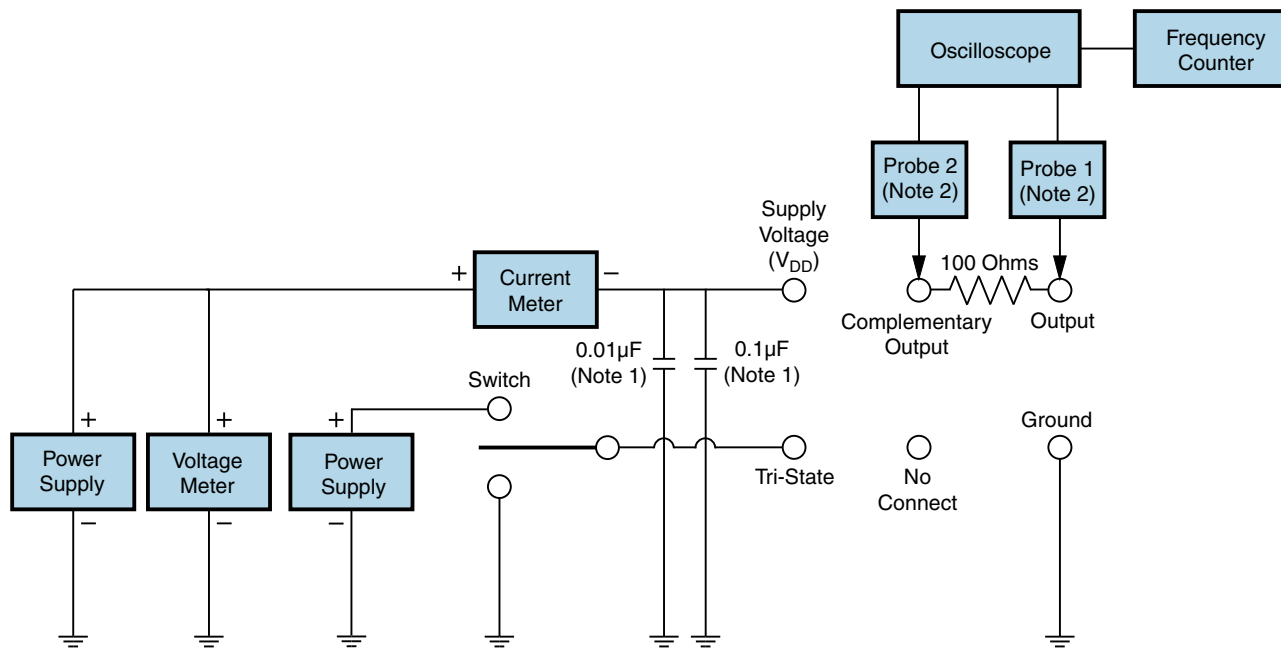

Note 1: An external  $0.01\mu\text{F}$  ceramic bypass capacitor in parallel with a  $0.1\mu\text{F}$  high frequency ceramic bypass capacitor close (less than 2mm) to the package ground and supply voltage pin is required.

Note 2: A low capacitance ( $<12\text{pF}$ ), 10X attenuation factor, high impedance ( $>10\text{Mohms}$ ), and high bandwidth ( $>500\text{MHz}$ ) passive probe is recommended.

Note 3: Test circuit PCB traces need to be designed for a characteristic line impedance of 50 ohms.

# EMRE12J2H-156.250M

## Recommended Solder Reflow Methods

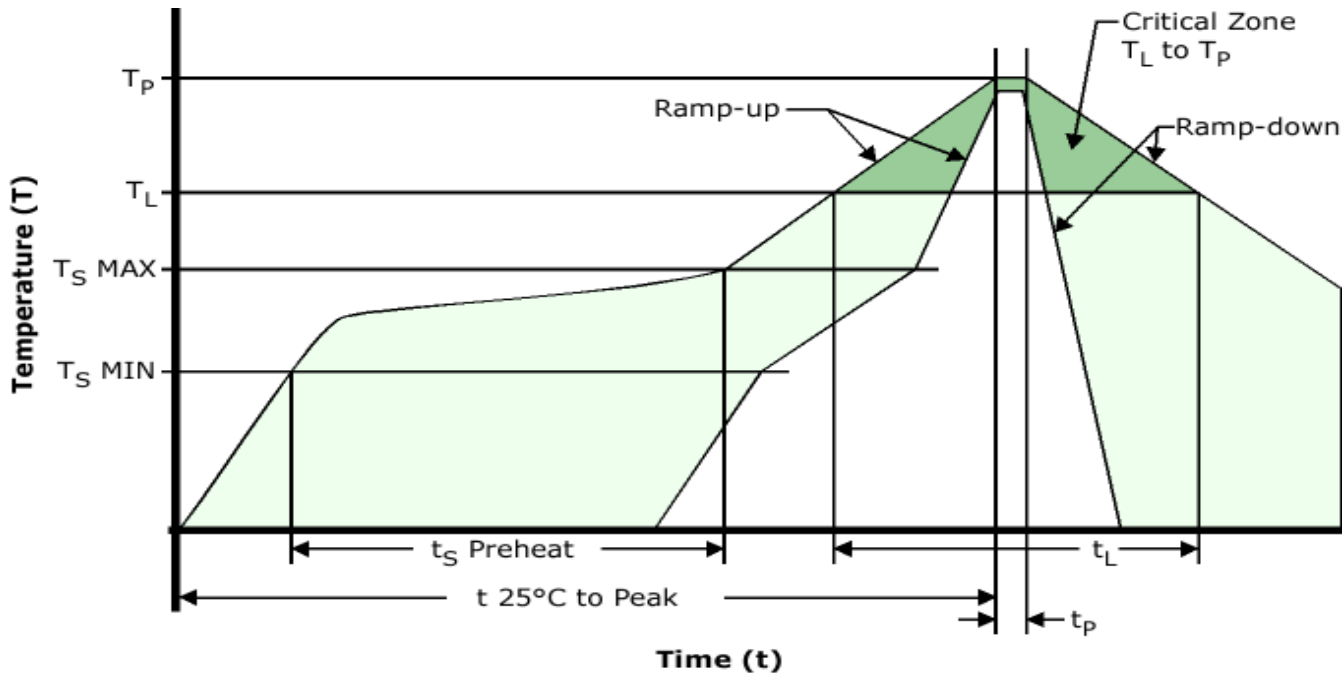

### High Temperature Infrared/Convection

$T_s$  MAX to  $T_L$  (Ramp-up Rate) 3°C/Second Maximum

#### Preheat

- Temperature Minimum ( $T_s$  MIN) 150°C
- Temperature Typical ( $T_s$  TYP) 175°C
- Temperature Maximum ( $T_s$  MAX) 200°C
- Time ( $t_s$  MIN) 60 - 180 Seconds

Ramp-up Rate ( $T_L$  to  $T_P$ ) 3°C/Second Maximum

#### Time Maintained Above:

- Temperature ( $T_L$ ) 217°C
- Time ( $t_L$ ) 60 - 150 Seconds

Peak Temperature ( $T_P$ ) 260°C Maximum for 10 Seconds Maximum

Target Peak Temperature ( $T_P$  Target) 250°C +0/-5°C

Time within 5°C of actual peak ( $t_p$ ) 20 - 40 Seconds

Ramp-down Rate 6°C/Second Maximum

Time 25°C to Peak Temperature (t) 8 Minutes Maximum

Moisture Sensitivity Level Level 1

# EMRE12J2H-156.250M

## Recommended Solder Reflow Methods

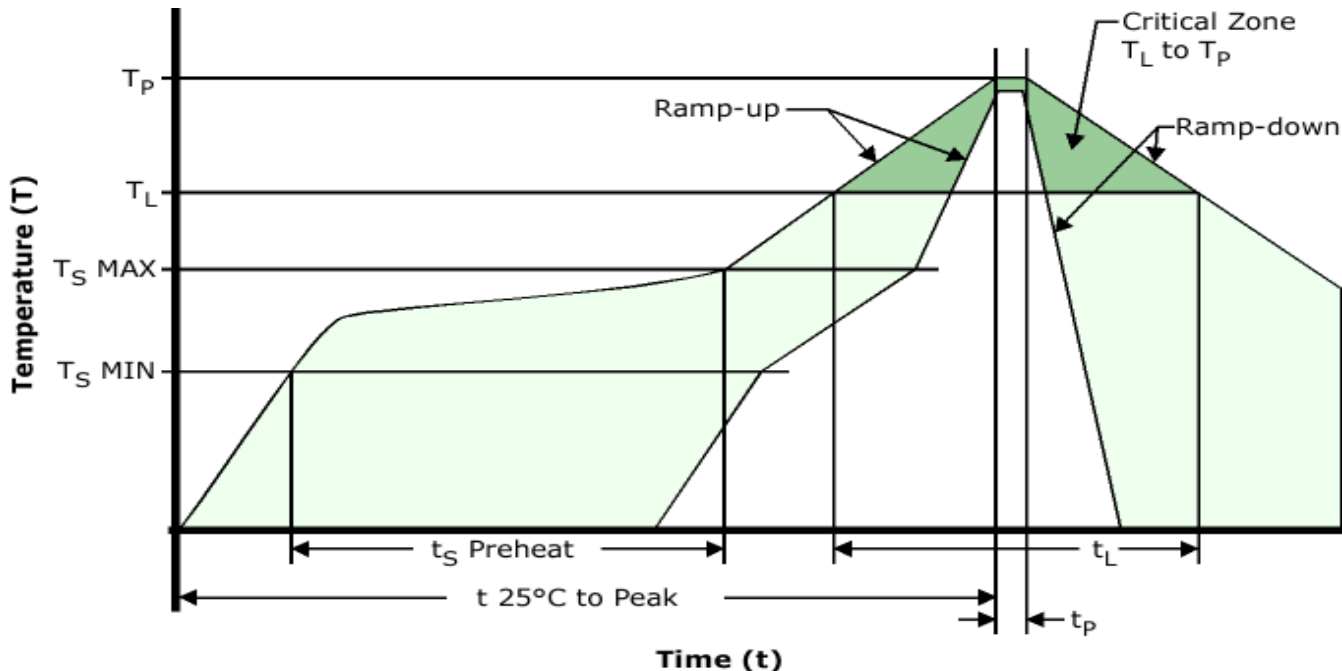

### Low Temperature Infrared/Convection 240°C

$T_S \text{ MAX}$  to  $T_L$  (Ramp-up Rate) 5°C/Second Maximum

#### Preheat

- Temperature Minimum ( $T_S \text{ MIN}$ ) N/A  
 - Temperature Typical ( $T_S \text{ TYP}$ ) 150°C  
 - Temperature Maximum ( $T_S \text{ MAX}$ ) N/A  
 - Time ( $t_s \text{ MIN}$ ) 60 - 120 Seconds

Ramp-up Rate ( $T_L$  to  $T_P$ ) 5°C/Second Maximum

#### Time Maintained Above:

- Temperature ( $T_L$ ) 150°C  
 - Time ( $t_L$ ) 200 Seconds Maximum

Peak Temperature ( $T_P$ ) 240°C Maximum

Target Peak Temperature ( $T_P \text{ Target}$ ) 240°C Maximum 2 Times / 230°C Maximum 1 Time

Time within 5°C of actual peak ( $t_p$ ) 10 Seconds Maximum 2 Times / 80 Seconds Maximum 1 Time

Ramp-down Rate 5°C/Second Maximum

Time 25°C to Peak Temperature (t) N/A

Moisture Sensitivity Level Level 1

### Low Temperature Manual Soldering

185°C Maximum for 10 Seconds Maximum, 2 times Maximum.

### High Temperature Manual Soldering

260°C Maximum for 5 Seconds Maximum, 2 times Maximum.

# Mouser Electronics

Authorized Distributor

Click to View Pricing, Inventory, Delivery & Lifecycle Information:

[Ecliptek:](#)

[EMRE12J2H-156.250M](#)



Компания «ЭлектроПласт» предлагает заключение долгосрочных отношений при поставках импортных электронных компонентов на взаимовыгодных условиях!

Наши преимущества:

- Оперативные поставки широкого спектра электронных компонентов отечественного и импортного производства напрямую от производителей и с крупнейших мировых складов;
- Поставка более 17-ти миллионов наименований электронных компонентов;
- Поставка сложных, дефицитных, либо снятых с производства позиций;
- Оперативные сроки поставки под заказ (от 5 рабочих дней);
- Экспресс доставка в любую точку России;
- Техническая поддержка проекта, помощь в подборе аналогов, поставка прототипов;
- Система менеджмента качества сертифицирована по Международному стандарту ISO 9001;
- Лицензия ФСБ на осуществление работ с использованием сведений, составляющих государственную тайну;
- Поставка специализированных компонентов (Xilinx, Altera, Analog Devices, Intersil, Interpoint, Microsemi, Aeroflex, Peregrine, Syfer, Eurofarad, Texas Instrument, Miteq, Cobham, E2V, MA-COM, Hittite, Mini-Circuits, General Dynamics и др.);

Помимо этого, одним из направлений компании «ЭлектроПласт» является направление «Источники питания». Мы предлагаем Вам помощь Конструкторского отдела:

- Подбор оптимального решения, техническое обоснование при выборе компонента;
- Подбор аналогов;
- Консультации по применению компонента;
- Поставка образцов и прототипов;
- Техническая поддержка проекта;
- Защита от снятия компонента с производства.



#### Как с нами связаться

**Телефон:** 8 (812) 309 58 32 (многоканальный)

**Факс:** 8 (812) 320-02-42

**Электронная почта:** [org@eplast1.ru](mailto:org@eplast1.ru)

**Адрес:** 198099, г. Санкт-Петербург, ул. Калинина, дом 2, корпус 4, литера А.