

### FEATURES

- Data rate: 460 kbps
- 2 Tx and 2 Rx
- Meets EIA-232E specifications
- 0.1  $\mu$ F charge pump capacitors
- ESD protection to IEC 1000-4-2 (801.2) on RS-232 I/Os
- Contact discharge:  $\pm 8$  kV
- Air gap discharge:  $\pm 15$  kV

### APPLICATIONS

- General-purpose RS-232 data link
- Portable instruments
- Handsets
- Industrial/telecom diagnostic ports

### GENERAL DESCRIPTION

The ADM3232E transceiver is a high speed, 2-channel RS-232/V.28 interface device that operates from a single 3.3 V power supply. Low power consumption makes it ideal for battery-powered portable instruments. The ADM3232E conforms to the EIA-232E and ITU-T V.28 specifications and operates at data rates up to 460 kbps.

All RS-232 (T<sub>XOUT</sub> and R<sub>XIN</sub>) inputs and outputs are protected against electrostatic discharges (up to  $\pm 15$  kV ESD protection). This ensures compliance with IEC 1000-4-2 requirements.

This device is ideally suited for operation in electrically harsh environments or where RS-232 cables are frequently plugged/unplugged, with the  $\pm 15$  kV ESD protection of the ADM3232E RS-232 input/output pins.

### FUNCTIONAL BLOCK DIAGRAM

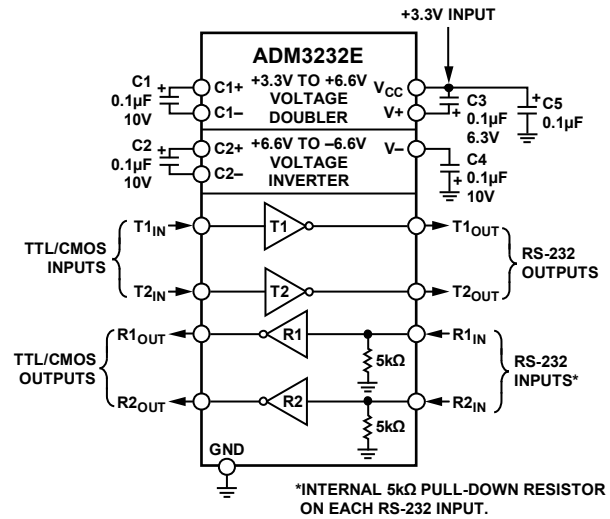

Figure 1.

Emissions are also controlled to within very strict limits. CMOS technology is used to keep the power dissipation to an absolute minimum, allowing maximum battery life in portable applications.

Four external 0.1  $\mu$ F charge pump capacitors are used for the voltage doubler/inverter, permitting operation from a single 3.3 V supply.

The ADM3232E is available in a 16-lead narrow and wide SOIC packages, as well as a space-saving 16-lead TSSOP.

### Rev. B

Information furnished by Analog Devices is believed to be accurate and reliable. However, no responsibility is assumed by Analog Devices for its use, nor for any infringements of patents or other rights of third parties that may result from its use. Specifications subject to change without notice. No license is granted by implication or otherwise under any patent or patent rights of Analog Devices. Trademarks and registered trademarks are the property of their respective owners.

## TABLE OF CONTENTS

Features .....	1	Pin Configuration and Function Descriptions.....	5
Applications.....	1	Typical Performance Characteristics .....	6
Functional Block Diagram .....	1	Theory of Operation .....	8
General Description .....	1	Circuit Description .....	8
Revision History .....	2	High Baud Rate.....	8
Specifications.....	3	Outline Dimensions .....	9
Absolute Maximum Ratings.....	4	Ordering Guide .....	10
ESD Caution.....	4		

## REVISION HISTORY

### 4/11—Rev. A to Rev. B

Changes to Features Section and General Description Section .....	1
Change to ESD Protection (RS-232 I/O Pins) Parameter, Table 1 .....	3
Change to ESD Protection on RS-232 Pins Section Heading.....	8

### 7/08—Rev. 0 to Rev. A

Added 16-Lead SOIC .....	Universal
Updated Outline Dimensions .....	9
Changes to Ordering Guide .....	10

### 12/06—Revision 0: Initial Version

## SPECIFICATIONS

$V_{CC} = 3.3 \text{ V} \pm 0.3 \text{ V}$ ,  $C1$  to  $C4 = 0.1 \mu\text{F}$ ; all specifications  $T_{MIN}$  to  $T_{MAX}$ , unless otherwise noted.

Table 1.

Parameter	Min	Typ	Max	Unit	Test Conditions/Comments
<b>DC CHARACTERISTICS</b>					
Operating Voltage Range	3.0	3.3	5.5	V	
$V_{CC}$ Power Supply Current		1.3	3	mA	No load
<b>LOGIC</b>					
Input Logic Threshold Low, $V_{INL}$			0.8	V	$T_{IN}$
Input Logic Threshold High, $V_{INH}$	2.0			V	$T_{IN}$
TTL/CMOS Output Voltage Low, $V_{OL}$			0.4	V	$I_{OUT} = 1.6 \text{ mA}$
TTL/CMOS Output Voltage High, $V_{OH}$	$V_{CC} - 0.6$			V	$I_{OUT} = -1 \text{ mA}$
Logic Pull-Up Current		5	10	$\mu\text{A}$	$T_{IN} = \text{GND to } V_{CC}$
Transmitter Input Hysteresis		0.5		V	
<b>RS-232 RECEIVER</b>					
Input Voltage Range	-30		+30	V	
Input Threshold Low	0.6	1.2		V	
Input Threshold High		1.6	2.4	V	
Input Hysteresis		0.4		V	
Input Resistance	3	5	7	$\text{k}\Omega$	
<b>RS-232 TRANSMITTER</b>					
Output Voltage Swing (RS-232)	$\pm 5.0$	$\pm 5.2$		V	$V_{CC} = 3.3 \text{ V}$ , all transmitter outputs loaded with $3 \text{ k}\Omega$ to ground
Output Voltage Swing (RS-562)	$\pm 3.7$			V	$V_{CC} = 3.0 \text{ V}$
Transmitter Output Resistance	300			$\Omega$	$V_{CC} = 0 \text{ V}$ , $V_{OUT} = \pm 2 \text{ V}$
Output Short-Circuit Current (RS-232)		$\pm 15$		mA	
<b>TIMING CHARACTERISTICS</b>					
Maximum Data Rate	460			kbps	$V_{CC} = 3.3 \text{ V}$ , $R_L = 3 \text{ k}\Omega$ to $7 \text{ k}\Omega$ , $C_L = 50 \text{ pF}$ to $1000 \text{ pF}$ , one Tx switching
Receiver Propagation Delay					
$t_{PHL}$		0.4	1	$\mu\text{s}$	
$t_{PLH}$		0.4	1	$\mu\text{s}$	
Transmitter Propagation Delay		300	1.2	$\mu\text{s}$	$R_L = 3 \text{ k}\Omega$ , $C_L = 1000 \text{ pF}$
Receiver Output Enable Time		200		ns	
Receiver Output Disable Time		200		ns	
Transmitter Skew		30		ns	
Receiver Skew		300		ns	
Transition Region Slew Rate	5.5	10	30	$\text{V}/\mu\text{s}$	Measured from $+3 \text{ V}$ to $-3 \text{ V}$ or $-3 \text{ V}$ to $+3 \text{ V}$ , $V_{CC} = 3.3 \text{ V}$ ; $R_L = 3 \text{ k}\Omega$ , $C_L = 1000 \text{ pF}$ , $T_A = 25^\circ\text{C}$
<b>ESD PROTECTION (RS-232 I/O PINS)</b>					
		$\pm 15$		kV	Human body model
		$\pm 15$		kV	IEC 1000-4-2 air discharge
		$\pm 8$		kV	IEC 1000-4-2 contact discharge

# ADM3232E

## ABSOLUTE MAXIMUM RATINGS

T<sub>A</sub> = 25°C, unless otherwise noted.

Table 2.

Parameter	Rating
V <sub>CC</sub>	−0.3 V to +6 V
V+	(V <sub>CC</sub> − 0.3 V) to 14 V
V−	+0.3 V to −14 V
Input Voltages	
T <sub>XIN</sub>	−0.3 V to (V <sub>CC</sub> + 0.3 V)
R <sub>XIN</sub>	±30 V
Output Voltages	
T <sub>XOUT</sub>	±15 V
R <sub>XOUT</sub>	−0.3 V to (V <sub>CC</sub> + 0.3 V)
Short-Circuit Duration	
T <sub>XOUT</sub>	Continuous
Power Dissipation R-16/RW-16 (Derate 6 mW/°C Above 50°C)	450 mW
θ <sub>JA</sub> , Thermal Impedance	158°C/W
Power Dissipation RU-16 (Derate 6 mW/°C Above 50°C)	500 mW
θ <sub>JA</sub> , Thermal Impedance	158°C/W
Operating Temperature Range	
Industrial (A Version)	−40°C to +85°C
Storage Temperature Range	−65°C to +150°C
Lead Temperature (Soldering, 10 sec)	JEDEC industry-standard J-STD-020

Stresses above those listed under Absolute Maximum Ratings may cause permanent damage to the device. This is a stress rating only; functional operation of the device at these or any other conditions above those indicated in the operational section of this specification is not implied. Exposure to absolute maximum rating conditions for extended periods may affect device reliability.

### ESD CAUTION



**ESD (electrostatic discharge) sensitive device.** Charged devices and circuit boards can discharge without detection. Although this product features patented or proprietary protection circuitry, damage may occur on devices subjected to high energy ESD. Therefore, proper ESD precautions should be taken to avoid performance degradation or loss of functionality.

## PIN CONFIGURATION AND FUNCTION DESCRIPTIONS

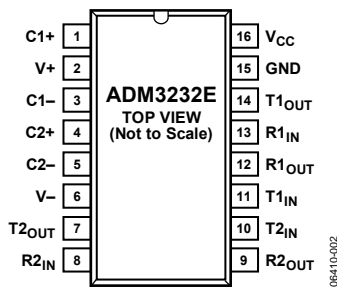

Figure 2. Pin Configuration

Table 3. Pin Function Descriptions

Pin No.	Mnemonic	Description
1, 3	C1+, C1-	External Capacitor 1 is connected between these pins. A 0.1 $\mu$ F capacitor is recommended, but larger capacitors of up to 47 $\mu$ F can be used.
2	V+	Internally Generated Positive Supply (6 V Nominal).
4, 5	C2+, C2-	External Capacitor 2 is connected between these pins. A 0.1 $\mu$ F capacitor is recommended, but larger capacitors of up to 47 $\mu$ F can be used.
6	V-	Internally Generated Negative Supply (-6 V Nominal).
7, 14	T2 <sub>OUT</sub> , T1 <sub>OUT</sub>	Transmitter (Driver) Outputs. These are RS-232 signal levels (typically $\pm 6$ V).
8, 13	R2 <sub>IN</sub> , R1 <sub>IN</sub>	Receiver Inputs. These inputs accept RS-232 signal levels. An internal 5 k $\Omega$ pull-down resistor to GND is connected on each input.
9, 12	R2 <sub>OUT</sub> , R1 <sub>OUT</sub>	Receiver Outputs. These are TTL/CMOS output logic levels.
10, 11	T2 <sub>IN</sub> , T1 <sub>IN</sub>	Transmitter (Driver) Inputs. These inputs accept TTL/CMOS levels.
15	GND	Ground Pin. Must be connected to 0 V.
16	V <sub>CC</sub>	Power Supply Input (3.3 V $\pm$ 0.3 V).

## TYPICAL PERFORMANCE CHARACTERISTICS

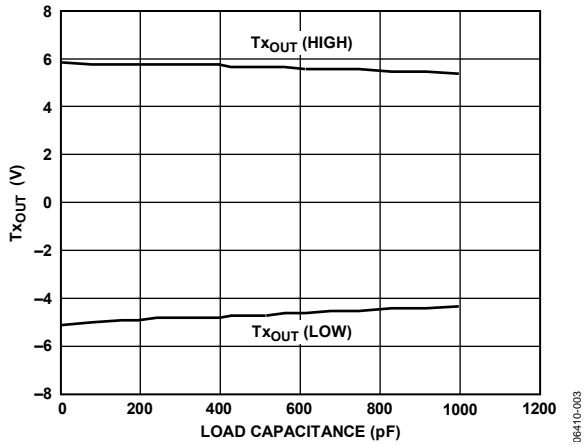

Figure 3. Transmitter Output Voltage High/Low vs. Load Capacitance @ 460 kbps

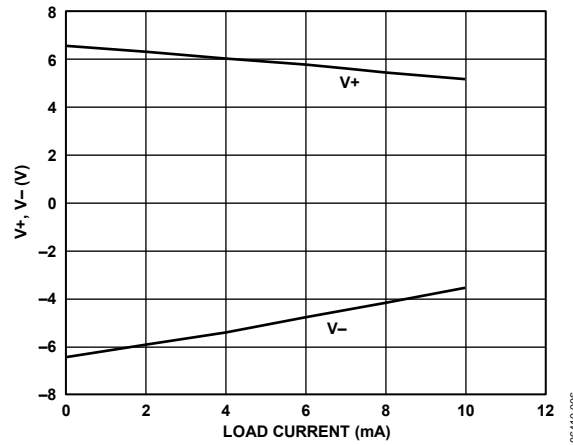

Figure 6. Charge Pump V+, V- vs. Load Current

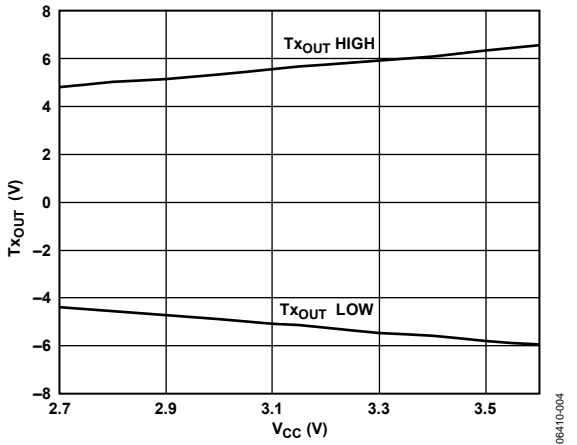

Figure 4. Transmitter Output Voltage vs. V<sub>CC</sub>

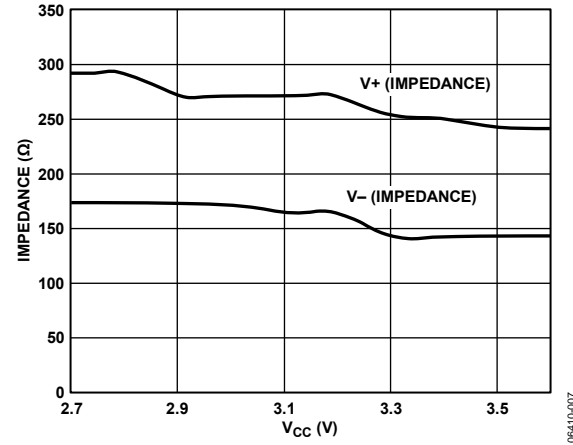

Figure 7. Charge Pump Impedance vs. V<sub>CC</sub>

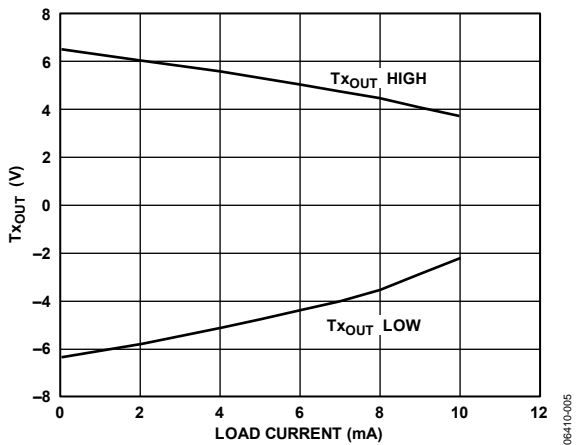

Figure 5. Transmitter Output Voltage High/Low vs. Load Current

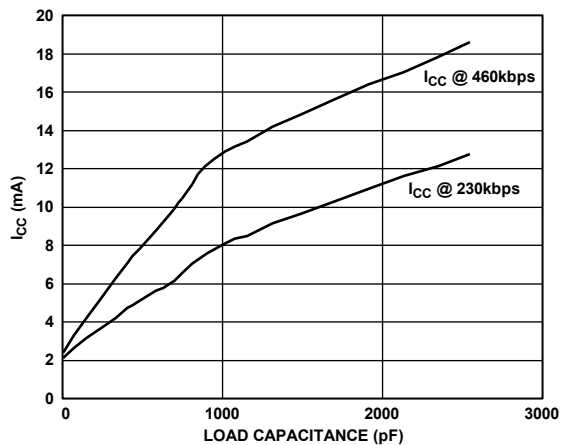

Figure 8. Power Supply Current vs. Load Capacitance

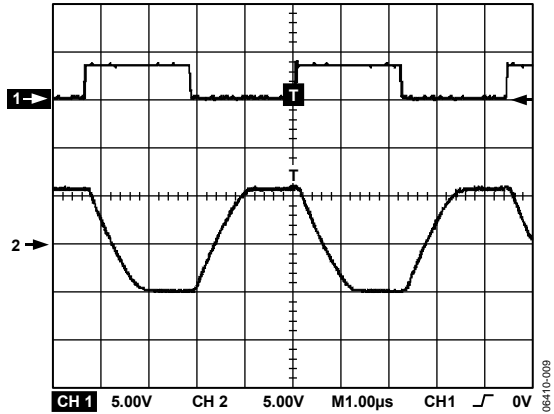

Figure 9. 460 kbps Data Transmission

# ADM3232E

## THEORY OF OPERATION

The ADM3232E is a single-channel RS-232 line driver/receiver. Step-up voltage converters, coupled with level-shifting transmitters and receivers, allow RS-232 levels to be developed while operating from a single 3.3 V supply.

CMOS technology is used to keep the power dissipation to an absolute minimum, allowing maximum battery life in portable applications.

## CIRCUIT DESCRIPTION

The internal circuitry consists of the following main sections:

- A charge pump voltage converter
- A 3.3 V logic to RS-232 transmitter
- An RS-232 to 3.3 V logic receiver

### Charge Pump Voltage Converter

The charge pump voltage converter consists of a 200 kHz oscillator and a switching matrix. The converter generates a  $\pm 6.6$  V supply from the input 3.3 V level. This is accomplished in two stages by using a switched capacitor technique as shown in Figure 10. First, the 3.3 V input supply is doubled to 6.6 V by using Capacitor C1 as the charge storage element. The +6.6 V level is then inverted to generate  $-6.6$  V, using C2 as the storage element.

Capacitor C3 and Capacitor C4 are used to reduce the output ripple. Their values are not critical and can be increased, if desired. Capacitor C3 is shown connected between  $V+$  and  $V_{CC}$ . It is also acceptable to connect this capacitor between  $V+$  and GND.

If desired, larger capacitors (up to 10  $\mu$ F) can be used for Capacitor C1 to Capacitor C4.

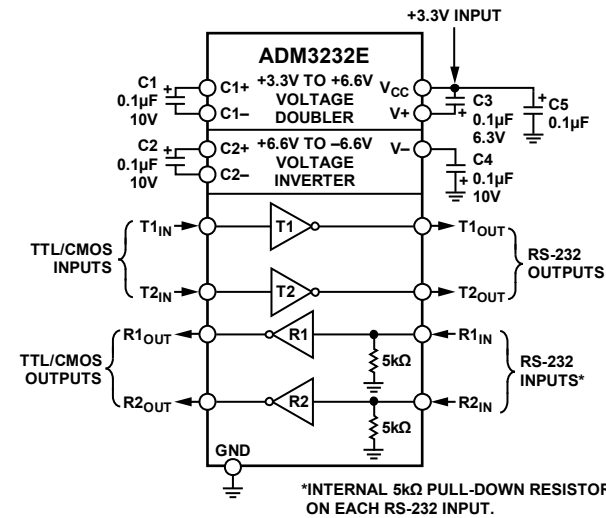

Figure 10. Typical Operating Circuit

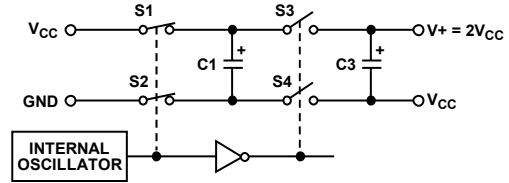

Figure 11. Charge Pump Voltage Doubler

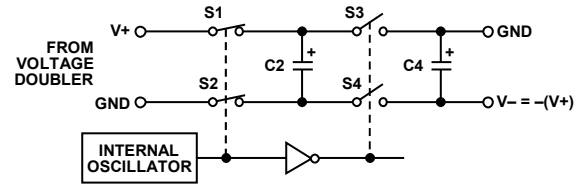

Figure 12. Charge Pump Voltage Inverter

### 3.3 V Logic to RS-232 Transmitter

The drivers convert 3.3 V logic input levels into RS-232 output levels. With  $V_{CC} = 3.3$  V and driving an RS-232 load, the output voltage swing is typically  $\pm 6$  V.

### RS-232 to 3.3 V Logic Receiver

The receivers are inverting level shifters that accept RS-232 input levels and translate them into 3 V logic output levels. The inputs have internal 5 k $\Omega$  pull-down resistors to ground and are protected against overvoltages up to  $\pm 30$  V. Unconnected inputs are pulled to 0 V by the internal 5 k $\Omega$  pull-down resistor. This results in a Logic 1 output level for unconnected inputs or for inputs connected to GND.

The receivers have Schmitt trigger inputs with a hysteresis level of 0.4 V. This ensures error-free reception for both noisy inputs and for inputs with slow transition times.

### ESD Protection on RS-232 Pins

All RS-232 ( $T_{XOUT}$  and  $R_{XIN}$ ) inputs and outputs are protected against electrostatic discharges (up to  $\pm 15$  kV). This ensures compliance with IEC 1000-4-2 requirements.

### HIGH BAUD RATE

The ADM3232E features high slew rates, permitting data transmission at rates well in excess of the EIA-232E specifications. RS-232 voltage levels are maintained at data rates up to 460 kbps, even under worst-case loading conditions. The slew rate is internally controlled to less than 30 V/ $\mu$ s to minimize EMI interference.



# OUTLINE DIMENSIONS

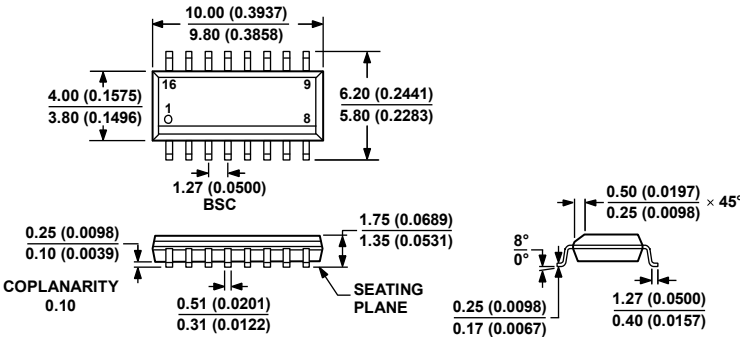

COMPLIANT TO JEDEC STANDARDS MS-012-AC  
CONTROLLING DIMENSIONS ARE IN MILLIMETERS; INCH DIMENSIONS (IN PARENTHESES) ARE ROUNDED-OFF MILLIMETER EQUIVALENTS FOR REFERENCE ONLY AND ARE NOT APPROPRIATE FOR USE IN DESIGN.

060606-A

Figure 13. 16-Lead Standard Small Outline Package [SOIC\_N] Narrow Body (R-16)  
Dimensions shown in millimeters (and inches)

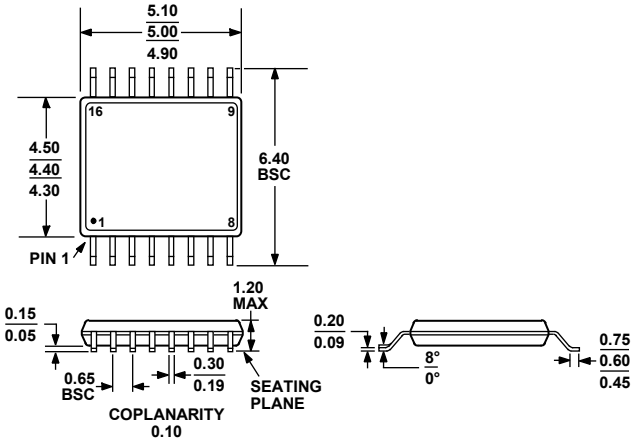

COMPLIANT TO JEDEC STANDARDS MO-153-AB  
Figure 14. 16-Lead Thin Shrink Small Outline Package [TSSOP] (RU-16)  
Dimensions shown in millimeters

# ADM3232E

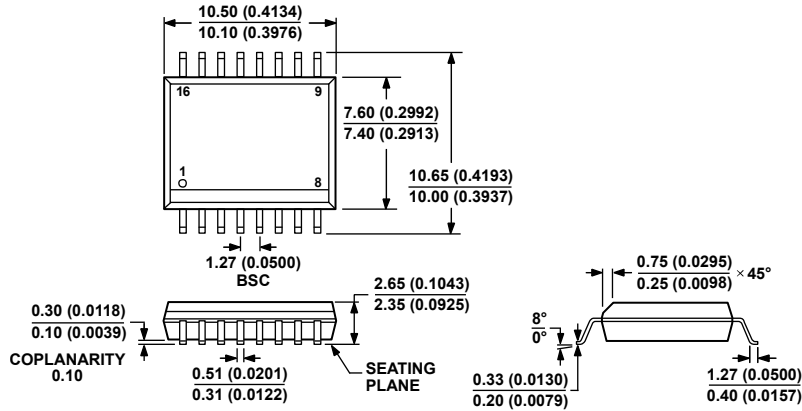

COMPLIANT TO JEDEC STANDARDS MS-013-AA  
 CONTROLLING DIMENSIONS ARE IN MILLIMETERS; INCH DIMENSIONS  
 (IN PARENTHESES) ARE ROUNDED-OFF MILLIMETER EQUIVALENTS FOR  
 REFERENCE ONLY AND ARE NOT APPROPRIATE FOR USE IN DESIGN.

03-27-2007-B

Figure 15. 16-Lead Standard Small Outline Package [SOIC\_W]  
 Wide Body  
 (RW-16)

Dimensions shown in millimeters (and inches)

## ORDERING GUIDE

Model <sup>1</sup>	Temperature Range	Package Description	Package Option
ADM3232EARNZ	-40°C to +85°C	16-Lead SOIC_N	R-16
ADM3232EARNZ-REEL7	-40°C to +85°C	16-Lead SOIC_N	R-16
ADM3232EARUZ	-40°C to +85°C	16-Lead TSSOP	RU-16
ADM3232EARUZ-REEL7	-40°C to +85°C	16-Lead TSSOP	RU-16
ADM3232EARWZ	-40°C to +85°C	16-Lead SOIC_W	RW-16
ADM3232EARWZ-REEL	-40°C to +85°C	16-Lead SOIC_W	RW-16

<sup>1</sup> Z = RoHS Compliant Part.

**NOTES**

**ADM3232E**

**NOTES**



Компания «ЭлектроПласт» предлагает заключение долгосрочных отношений при поставках импортных электронных компонентов на взаимовыгодных условиях!

Наши преимущества:

- Оперативные поставки широкого спектра электронных компонентов отечественного и импортного производства напрямую от производителей и с крупнейших мировых складов;
- Поставка более 17-ти миллионов наименований электронных компонентов;
- Поставка сложных, дефицитных, либо снятых с производства позиций;
- Оперативные сроки поставки под заказ (от 5 рабочих дней);
- Экспресс доставка в любую точку России;
- Техническая поддержка проекта, помощь в подборе аналогов, поставка прототипов;
- Система менеджмента качества сертифицирована по Международному стандарту ISO 9001;
- Лицензия ФСБ на осуществление работ с использованием сведений, составляющих государственную тайну;
- Поставка специализированных компонентов (Xilinx, Altera, Analog Devices, Intersil, Interpoint, Microsemi, Aeroflex, Peregrine, Syfer, Eurofarad, Texas Instrument, Miteq, Cobham, E2V, MA-COM, Hittite, Mini-Circuits, General Dynamics и др.);

Помимо этого, одним из направлений компании «ЭлектроПласт» является направление «Источники питания». Мы предлагаем Вам помощь Конструкторского отдела:

- Подбор оптимального решения, техническое обоснование при выборе компонента;
- Подбор аналогов;
- Консультации по применению компонента;
- Поставка образцов и прототипов;
- Техническая поддержка проекта;
- Защита от снятия компонента с производства.



#### Как с нами связаться

**Телефон:** 8 (812) 309 58 32 (многоканальный)

**Факс:** 8 (812) 320-02-42

**Электронная почта:** [org@eplast1.ru](mailto:org@eplast1.ru)

**Адрес:** 198099, г. Санкт-Петербург, ул. Калинина, дом 2, корпус 4, литера А.