

**SINGLE-PHASE GLASS PASSIVATED
SILICON BRIDGE RECTIFIER**
VOLTAGE RANGE 100 to 1000 Volts CURRENT 0.8 Ampere

FEATURES

- * Surge overload rating - 30 amperes peak
- * Ideal for printed circuit board
- * Reliable low cost construction utilizing molded
- * Glass passivated device
- * Polarity symbols molded on body
- * Mounting position: Any
- * P/N suffix V means AEC-Q101 qualified, e.g:MB1FV
- * P/N suffix V means Halogen-free

MECHANICAL DATA

- * Epoxy: Device has UL flammability classification 94V-O

MAXIMUM RATINGS AND ELECTRICAL CHARACTERISTICS

Ratings at 25 °C ambient temperature unless otherwise specified.
resistive or inductive load.

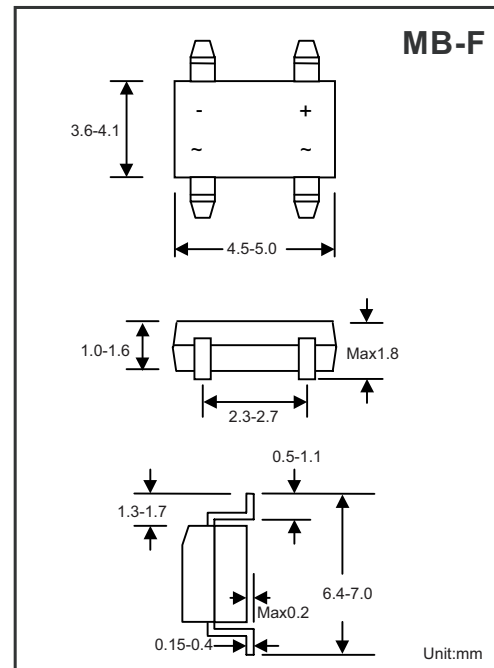

MAXIMUM RATINGS (At $T_A = 25^\circ\text{C}$ unless otherwise noted)

RATINGS		SYMBOL	MB1F	MB2F	MB4F	MB6F	MB8F	MB10F	UNITS
Maximum Recurrent Peak Reverse Voltage		V_{RRM}	100	200	400	600	800	1000	Volts
Maximum RMS Bridge Input Voltage		V_{RMS}	70	140	280	420	560	700	Volts
Maximum DC Blocking Voltage		V_{DC}	100	200	400	600	800	1000	Volts
Maximum Average Forward Rectified Current	$T_A = 125^\circ\text{C}$	I_o	0.5						Amps
	$T_A = 110^\circ\text{C}$		0.8						
Peak Forward Surge Current 8.3 ms single half sine-wave superimposed on rated load (JEDEC method)		I_{FSM}	30						Amps
Peak Forward Surge Current 10 ms single half sine-wave superimposed on rated load (JEDEC method)		I_{FSM}	27.3						Amps
Typical Current Squared Time		I^2t	3.74						A^2S
Typical Thermal Resistance(Note2)		$R_{\theta JA}$	64						$^\circ\text{C}/\text{W}$
		$R_{\theta JL}$	39						
Operating and Storage Temperature Range		T_J, T_{STG}	-55 to + 150						$^\circ\text{C}$

ELECTRICAL CHARACTERISTICS (At $T_A = 25^\circ\text{C}$ unless otherwise noted)

CHARACTERISTICS		SYMBOL	MB1F	MB2F	MB4F	MB6F	MB8F	MB10F	UNITS
Maximum Forward Voltage Drop per Bridge Element at 0.8 A DC		V_F	1.1						Volts
Maximum Reverse Current at Rated DC Blocking Voltage per element	@ $T_A = 25^\circ\text{C}$	I_R	1.0						μAmps
	@ $T_A = 150^\circ\text{C}$		2						mAmps

NOTES:1. Typical Thermal Resistance : At 9.5mm lead lengths, PCB mounted.

2019-03/18
REV:F

RATING AND CHARACTERISTICS CURVES (MB1F THRU MB10F)

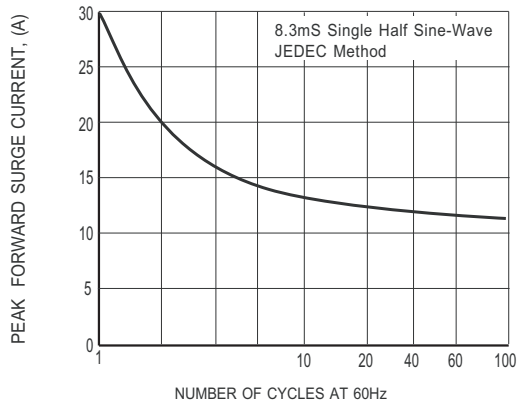

FIG. 1 MAXIMUM NON-REPETITIVE FORWARD SURGE CURRENT

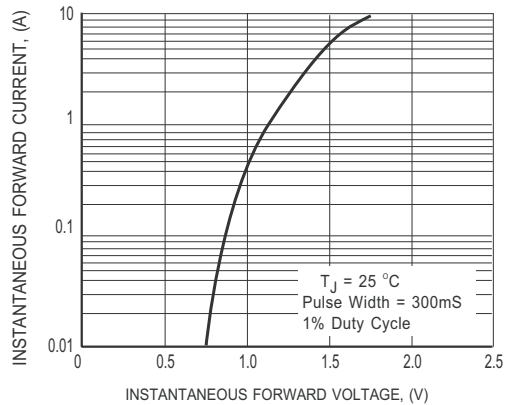

FIG. 2 MAXIMUM INSTANTANEOUS FORWARD CHARACTERISTICS

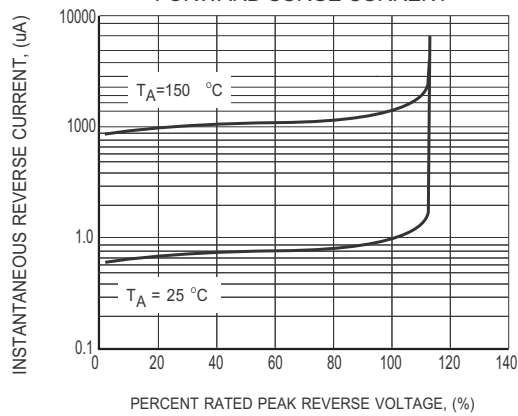

FIG. 3 MAXIMUM REVERSE CHARACTERISTICS

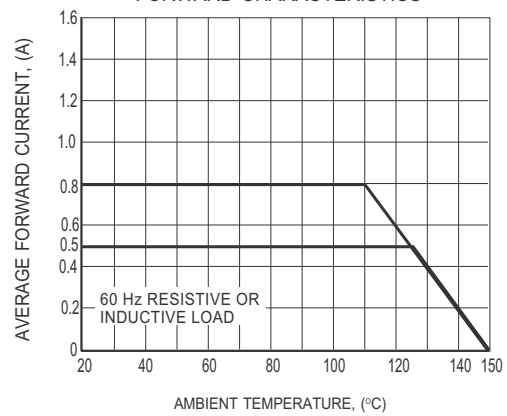
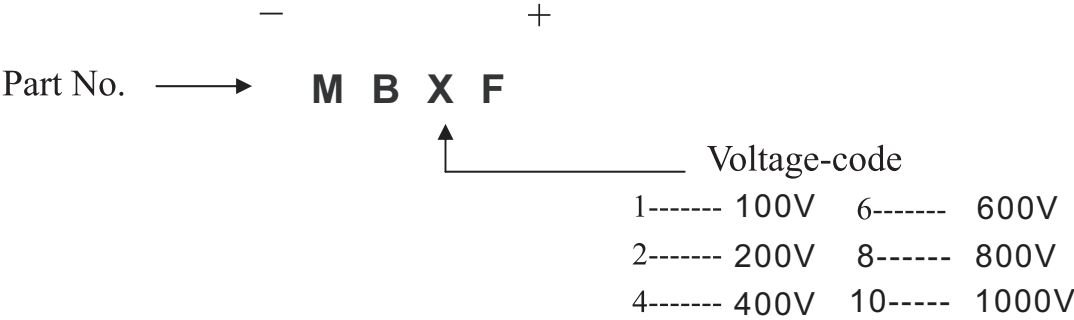
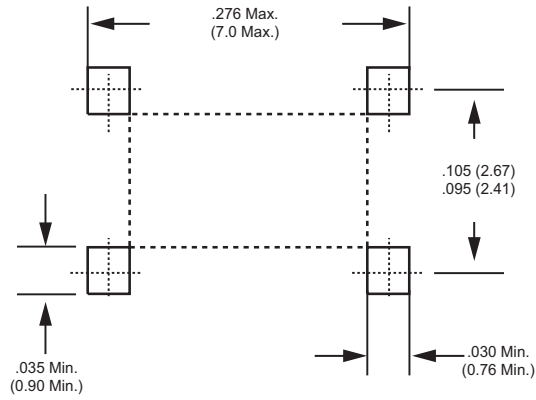

FIG. 4 TYPICAL FORWARD CURRENT DERATING CURVE

Marking Description



Mounting Pad Layout



Dimensions in inches and (millimeters)

PACKAGING OF DIODE AND BRIDGE RECTIFIERS

REEL PACK

PACKAGE	PACKING CODE	EA PER REEL	EA PER INNER BOX	COMPONENT SPACE (mm)	TAPE SPACE (mm)	REEL DIA (mm)	CARTON SIZE (mm)	EA PER CARTON	GROSS WEIGHT(Kg)
MB-F	-W	5,000	10,000			330	360*335*360	80,000	25.83

DISCLAIMER NOTICE

Rectron Inc reserves the right to make changes without notice to any product specification herein, to make corrections, modifications, enhancements or other changes. Rectron Inc or anyone on its behalf assumes no responsibility or liability for any errors or inaccuracies. Data sheet specifications and its information contained are intended to provide a product description only. "Typical" parameters which may be included on RECTRON data sheets and/ or specifications can and do vary in different applications and actual performance may vary over time. Rectron Inc does not assume any liability arising out of the application or use of any product or circuit.

Rectron products are not designed, intended or authorized for use in medical, life-saving implant or other applications intended for life-sustaining or other related applications where a failure or malfunction of component or circuitry may directly or indirectly cause injury or threaten a life without expressed written approval of Rectron Inc. Customers using or selling Rectron components for use in such applications do so at their own risk and shall agree to fully indemnify Rectron Inc and its subsidiaries harmless against all claims, damages and expenditures.



Компания «ЭлектроПласт» предлагает заключение долгосрочных отношений при поставках импортных электронных компонентов на взаимовыгодных условиях!

Наши преимущества:

- Оперативные поставки широкого спектра электронных компонентов отечественного и импортного производства напрямую от производителей и с крупнейших мировых складов;
- Поставка более 17-ти миллионов наименований электронных компонентов;
- Поставка сложных, дефицитных, либо снятых с производства позиций;
- Оперативные сроки поставки под заказ (от 5 рабочих дней);
- Экспресс доставка в любую точку России;
- Техническая поддержка проекта, помощь в подборе аналогов, поставка прототипов;
- Система менеджмента качества сертифицирована по Международному стандарту ISO 9001;
- Лицензия ФСБ на осуществление работ с использованием сведений, составляющих государственную тайну;
- Поставка специализированных компонентов (Xilinx, Altera, Analog Devices, Intersil, Interpoint, Microsemi, Aeroflex, Peregrine, Syfer, Eurofarad, Texas Instrument, Miteq, Cobham, E2V, MA-COM, Hittite, Mini-Circuits, General Dynamics и др.);

Помимо этого, одним из направлений компании «ЭлектроПласт» является направление «Источники питания». Мы предлагаем Вам помощь Конструкторского отдела:

- Подбор оптимального решения, техническое обоснование при выборе компонента;
- Подбор аналогов;
- Консультации по применению компонента;
- Поставка образцов и прототипов;
- Техническая поддержка проекта;
- Защита от снятия компонента с производства.



Как с нами связаться

Телефон: 8 (812) 309 58 32 (многоканальный)

Факс: 8 (812) 320-02-42

Электронная почта: org@eplast1.ru

Адрес: 198099, г. Санкт-Петербург, ул. Калинина, дом 2, корпус 4, литера А.