



Aluminum electrolytic capacitors

Axial-lead capacitors

Series/Type: B43698
Date: November 2008

Applications

- Electronic ballasts

Features

- Extremely long useful life
- Very high ripple current capability
- Very high voltage capability
550 V DC/85 °C/5000 h
500 V DC/105 °C/10000 h
- Outstanding performance

Construction

- Charge/discharge-proof, polar
- Aluminum case with insulating sleeve
- Negative pole connected to case
- Axial leads, welded to ensure perfect electrical contact

Taping and packing

- Bulk
- Pallet package
- Capacitors with $d \times l \leq 16 \times 30$ mm are also available taped on reel.



Specifications and characteristics in brief

Rated voltage V_R	450 V DC					
Surge voltage V_S	550 V DC at 105 °C					
Rated capacitance C_R	6.8 ... 33 μ F					
Capacitance tolerance	–10/+30% \triangle Q					
Leakage current I_{leak} (5 min, 20 °C)	$I_{leak} \leq 0.3 \mu A \cdot \left(\frac{C_R}{\mu F} \cdot \frac{V_R}{V} \right)^{0.7} + 4 \mu A$					
Self-inductance ESL ¹⁾	Diameter d (mm)	12	13.3	14	16	18
	Length l (mm)	Approx. ESL (nH)				
	30	21	–	24	29	34
	39	23	28	–	33	38
Useful life	Requirements: $\Delta C/C \leq \pm 30\%$ of initial value ESR ≤ 3 times initial specified limit $I_{leak} \leq$ initial specified limit					
105 °C; V_R ; $I_{AC,R}$						> 15000 h
105 °C; 500 V DC; $I_{AC,R}$						> 10000 h
90 °C; V_R ; $I_{AC,R}$						> 50000 h
85 °C; 500 V DC; $I_{AC,R}$						> 50000 h
40 °C; V_R ; 2.1 · $I_{AC,R}$						> 500000 h
40 °C; 500 V DC; 2.2 · $I_{AC,R}$	> 250000 h					
Voltage endurance test	7500 h					
105 °C; V_R						
Post test requirements: $\Delta C/C \leq \pm 10\%$ of initial value ESR ≤ 1.3 times initial specified limit $I_{leak} \leq$ initial specified limit						
Vibration resistance test	To IEC 60068-2-6, test Fc: Displacement amplitude 0.75 mm, frequency range 10 Hz ... 55 Hz, acceleration max. 10 g, duration 3 × 2 h. Capacitor mounted by its wire leads at a distance of (6 ± 1) mm from the case and additionally clamped by the case.					
IEC climatic category	To IEC 60068-1: 40/105/56 (–40 °C/+105 °C/56 days damp heat test)					
Detail specification	Similar to CECC 30301-801					
Sectional specification	IEC 60384-4					

1) If optimum circuit design is used, the values are lower by 30%.



B43698

High performance – 105 °C

Axial-lead capacitors

Dimensional drawing

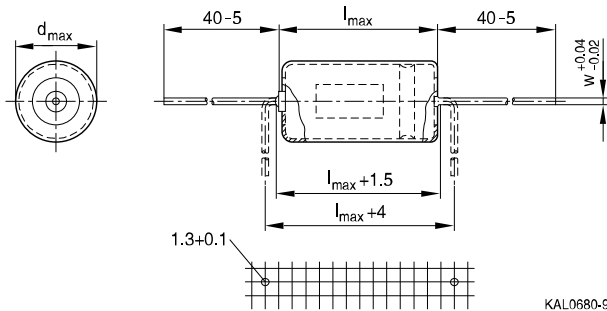

KAL0680-9

Dimensions, weights and packing units

d × l	d _{max} × l _{max}	Wire w	Approx. weight	Packing units (pcs.)		
				Bulk	Pallet	Reel
12 × 30	12.5 × 30.5	0.8	5.1	600	288	450
12 × 39	12.5 × 40	0.8	6.5	500	288	—
13.3 × 39	14.0 × 40	0.8	8.0	400	200	—
14 × 30	14.5 × 30.5	0.8	6.8	400	200	350
16 × 30	16.5 × 30.5	0.8	8.9	350	180	250
16 × 39	16.5 × 40	0.8	11.7	300	180	—
18 × 30	18.5 × 30.5	1.0	11.1	300	160	—
18 × 39	18.5 × 40	1.0	14.7	250	160	—

Case dimensions and ordering codes

V_R	C_R 100 Hz 20 °C μF	Case dimensions $d \times l$ mm	Ordering code	Ordering code	Ordering code
			Bulk	Pallet package	Reel
450	6.8	12 × 30	B43698A5685Q000	B43698A5685Q007	B43698A5685Q009
	10	12 × 39	B43698B5106Q000	B43698B5106Q007	
	10 ▽	14 × 30	B43698A5106Q000	B43698A5106Q007	B43698A5106Q009
	15	13.3 × 39	B43698B5156Q000	B43698B5156Q007	
	15 ▽	16 × 30	B43698A5156Q000	B43698A5156Q007	B43698A5156Q009
	22	16 × 39	B43698A5226Q000	B43698A5226Q007	
	22 ▽	18 × 30	B43698B5226Q000	B43698B5226Q007	
	33	18 × 39	B43698A5336Q000	B43698A5336Q007	

▽ Variant with different case dimensions

Technical data

C_R 100 Hz 20 °C μF	ESR_{typ} 100 Hz 20 °C Ω	ESR_{max} 100 Hz 20 °C Ω	ESR_{max} 100 Hz -25 °C Ω	ESR_{max} 10 kHz 20 °C Ω	Z_{max} 100 kHz 20 °C Ω	$I_{\text{AC,max}}$ 10 kHz 60 °C A	$I_{\text{AC,max}}$ 10 kHz 85 °C A	$I_{\text{AC,R}}$ 10 kHz 105 °C A
$V_R = 450 \text{ V DC}$								
6.8	7.2	12.0	180	5.5	5.4	1.26	1.03	0.54
10	4.9	8.1	120	3.8	3.7	1.74	1.42	0.75
10 ▽	4.9	8.1	120	3.8	3.7	1.65	1.34	0.71
15	3.2	5.4	80	2.5	2.4	2.24	1.82	0.96
15 ▽	3.2	5.4	80	2.5	2.4	2.13	1.74	0.92
22	2.2	3.7	50	1.7	1.6	2.94	2.40	1.26
22 ▽	2.2	3.7	50	1.7	1.6	2.68	2.19	1.15
33	1.5	2.5	40	1.2	1.1	3.73	3.04	1.60

▽ Variant with different case dimensions



B43698

High performance – 105 °C

Useful life

depending on ambient temperature T_A under ripple current operating conditions at $V_R^{1)}$

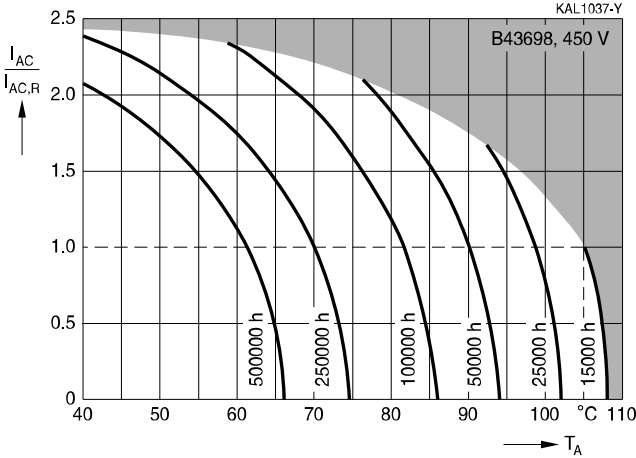

Useful life

depending on ambient temperature T_A under ripple current operating conditions at $V_{op}^{1)}$

$V_{op} = 500 V$

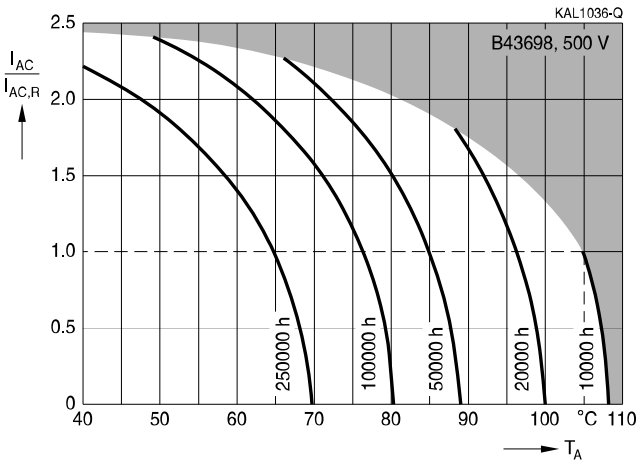

1) Refer to chapter "General technical information, 5.3 Calculation of useful life" for an explanation on how to interpret the useful life graphs.



Frequency factor of permissible ripple current I_{AC} versus frequency f

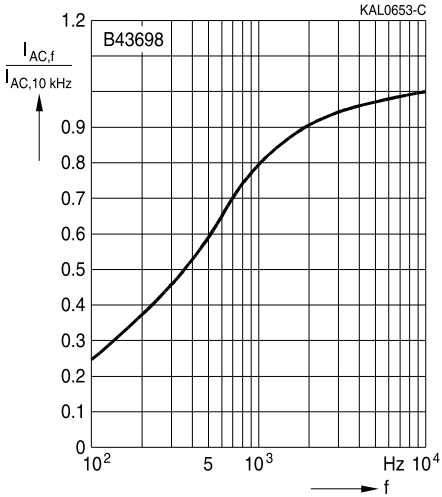

Frequency characteristics of ESR
Typical behavior

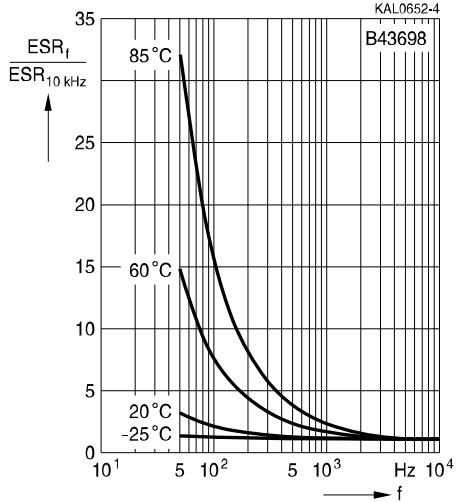

Equivalent series resistance ESR versus frequency f

Typical behavior for 22 μ F/450 V

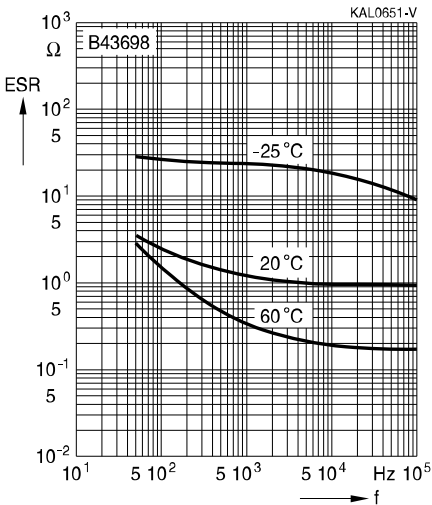

Impedance Z versus frequency f

Typical behavior for 22 μ F/450 V

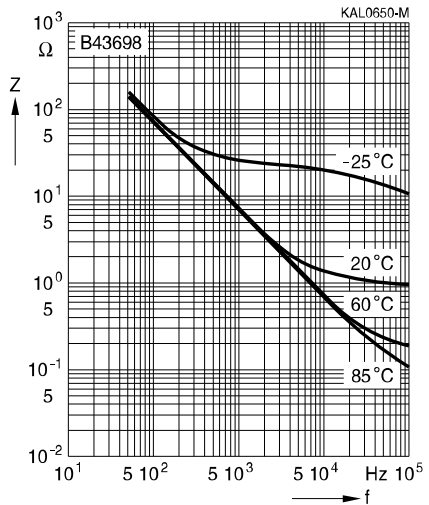



B43698

High performance – 105 °C

Cautions and warnings

Personal safety

The electrolytes used by EPCOS have not only been optimized with a view to the intended application, but also with regard to health and environmental compatibility. They do not contain any solvents that are detrimental to health, e.g. dimethyl formamide (DMF) or dimethyl acetamide (DMAC).

Furthermore, part of the high-voltage electrolytes used by EPCOS are self-extinguishing. They contain flame-retarding substances which will quickly extinguish any flame that may have been ignited.

As far as possible, EPCOS does not use any dangerous chemicals or compounds to produce operating electrolytes. However, in exceptional cases, such materials must be used in order to achieve specific physical and electrical properties because no safe substitute materials are currently known. However, the amount of dangerous materials used in our products has been limited to an absolute minimum. Nevertheless, the following rules should be observed when handling Al electrolytic capacitors:

- Any escaping electrolyte should not come into contact with eyes or skin.
- If electrolyte does come into contact with the skin, wash the affected parts immediately with running water. If the eyes are affected, rinse them for 10 minutes with plenty of water. If symptoms persist, seek medical treatment.
- Avoid breathing in electrolyte vapor or mists. Workplaces and other affected areas should be well ventilated. Clothing that has been contaminated by electrolyte must be changed and rinsed in water.



Product safety

The table below summarizes the safety instructions that must be observed without fail. A detailed description can be found in the relevant sections of chapter "General technical information".

Topic	Safety information	Reference Chapter "General technical information"
Polarity	Make sure that polar capacitors are connected with the right polarity.	1 "Basic construction of aluminum electrolytic capacitors"
Reverse voltage	Voltages polarity classes should be prevented by connecting a diode.	3.1.6 "Reverse voltage"
Upper category temperature	Do not exceed the upper category temperature.	7.2 "Maximum permissible operating temperature"
Maintenance	Make periodic inspections of the capacitors. Before the inspection, make sure that the power supply is turned off and carefully discharge the electricity of the capacitors. Do not apply any mechanical stress to the capacitor terminals.	10 "Maintenance"
Mounting position of screw terminal capacitors	Do not mount the capacitor with the terminals (safety vent) upside down.	11.1 "Mounting positions of capacitors with screw terminals"
Mounting of single-ended capacitors	The internal structure of single-ended capacitors might be damaged if excessive force is applied to the lead wires. Avoid any compressive, tensile or flexural stress. Do not move the capacitor after soldering to PC board. Do not pick up the PC board by the soldered capacitor. Do not insert the capacitor on the PC board with a hole space different to the lead space specified.	11.4 "Mounting considerations for single-ended capacitors"
Robustness of terminals	The following maximum tightening torques must not be exceeded when connecting screw terminals: M5: 2 Nm M6: 2.5 Nm	11.3 "Mounting torques"
Soldering	Do not exceed the specified time or temperature limits during soldering.	11.5 "Soldering"



B43698

High performance – 105 °C

Topic	Safety information	Reference Chapter "General technical information"
Soldering, cleaning agents	Do not allow halogenated hydrocarbons to come into contact with aluminum electrolytic capacitors.	11.6 "Cleaning agents"
Passive flammability	Avoid external energy, such as fire or electricity.	8.1 "Passive flammability"
Active flammability	Avoid overload of the capacitors.	8.2 "Active flammability"
		Reference Chapter "Capacitors with screw terminals"
Breakdown strength of insulating sleeves	Do not damage the insulating sleeve, especially when ring clips are used for mounting.	"Screw terminals - accessories"

Symbols and terms

Symbol	English	German
C	Capacitance	Kapazität
C_R	Rated capacitance	Nennkapazität
C_S	Series capacitance	Serienkapazität
$C_{S,T}$	Series capacitance at temperature T	Serienkapazität bei Temperatur T
C_f	Capacitance at frequency f	Kapazität bei Frequenz f
d	Case diameter, nominal dimension	Gehäusedurchmesser, Nennmaß
d_{max}	Maximum case diameter	Maximaler Gehäusedurchmesser
ESL	Self-inductance	Eigeninduktivität
ESR	Equivalent series resistance	Ersatzserienwiderstand
ESR_f	Equivalent series resistance at frequency f	Ersatzserienwiderstand bei Frequenz f
ESR_T	Equivalent series resistance at temperature T	Ersatzserienwiderstand bei Temperatur T
f	Frequency	Frequenz
I	Current	Strom
I_{AC}	Alternating current (ripple current)	Wechselstrom
$I_{AC,rms}$	Root-mean-square value of alternating current	Wechselstrom, Effektivwert
$I_{AC,f}$	Ripple current at frequency f	Wechselstrom bei Frequenz f
$I_{AC,max}$	Maximum permissible ripple current	Maximal zulässiger Wechselstrom
$I_{AC,R}$	Rated ripple current	Nennwechselstrom
$I_{AC,R} (B)$	Rated ripple current for base cooling	Nennwechselstromstrom für Bodenkühlung
I_{leak}	Leakage current	Ableitstrom
$I_{leak,op}$	Operating leakage current	Ableitstrom bei Betrieb
l	Case length, nominal dimension	Gehäuselänge, Nennmaß
l_{max}	Maximum case length (without terminals and mounting stud)	Maximale Gehäuselänge (ohne Anschlüsse und Gewindebolzen)
R	Resistance	Widerstand
R_{ins}	Insulation resistance	Isolationswiderstand
R_{symm}	Balancing resistance	Symmetrierwiderstand
T	Temperature	Temperatur
ΔT	Temperature difference	Temperaturdifferenz
T_A	Ambient temperature	Umgebungstemperatur
T_C	Case temperature	Gehäusetemperatur
T_B	Capacitor base temperature	Temperatur des Becherbodens
t	Time	Zeit
Δt	Period	Zeitraum
t_b	Service life (operating hours)	Brauchbarkeitsdauer (Betriebszeit)

B43698
High performance – 105 °C

Symbol	English	German
V	Voltage	Spannung
V _F	Forming voltage	Formierspannung
V _{op}	Operating voltage	Betriebsspannung
V _R	Rated voltage, DC voltage	Nennspannung, Gleichspannung
V _S	Surge voltage	Spitzenspannung
X _C	Capacitive reactance	Kapazitiver Blindwiderstand
X _L	Inductive reactance	Induktiver Blindwiderstand
Z	Impedance	Scheinwiderstand
Z _T	Impedance at temperature T	Scheinwiderstand bei Temperatur T
tan δ	Dissipation factor	Verlustfaktor
λ	Failure rate	Ausfallrate
ε ₀	Absolute permittivity	Elektrische Feldkonstante
ε _r	Relative permittivity	Dielektrizitätszahl
ω	Angular velocity; 2 · π · f	Kreisfrequenz; 2 · π · f

Notes

All dimensions are given in mm.

Important notes

The following applies to all products named in this publication:

1. Some parts of this publication contain **statements about the suitability of our products for certain areas of application**. These statements are based on our knowledge of typical requirements that are often placed on our products in the areas of application concerned. We nevertheless expressly point out **that such statements cannot be regarded as binding statements about the suitability of our products for a particular customer application**. As a rule, EPCOS is either unfamiliar with individual customer applications or less familiar with them than the customers themselves. For these reasons, it is always ultimately incumbent on the customer to check and decide whether an EPCOS product with the properties described in the product specification is suitable for use in a particular customer application.
2. We also point out that **in individual cases, a malfunction of electronic components or failure before the end of their usual service life cannot be completely ruled out in the current state of the art, even if they are operated as specified**. In customer applications requiring a very high level of operational safety and especially in customer applications in which the malfunction or failure of an electronic component could endanger human life or health (e.g. in accident prevention or lifesaving systems), it must therefore be ensured by means of suitable design of the customer application or other action taken by the customer (e.g. installation of protective circuitry or redundancy) that no injury or damage is sustained by third parties in the event of malfunction or failure of an electronic component.
3. **The warnings, cautions and product-specific notes must be observed.**
4. In order to satisfy certain technical requirements, **some of the products described in this publication may contain substances subject to restrictions in certain jurisdictions (e.g. because they are classed as hazardous)**. Useful information on this will be found in our Material Data Sheets on the Internet (www.epcos.com/material). Should you have any more detailed questions, please contact our sales offices.
5. We constantly strive to improve our products. Consequently, **the products described in this publication may change from time to time**. The same is true of the corresponding product specifications. Please check therefore to what extent product descriptions and specifications contained in this publication are still applicable before or when you place an order. We also **reserve the right to discontinue production and delivery of products**. Consequently, we cannot guarantee that all products named in this publication will always be available. The aforementioned does not apply in the case of individual agreements deviating from the foregoing for customer-specific products.
6. Unless otherwise agreed in individual contracts, **all orders are subject to the current version of the "General Terms of Delivery for Products and Services in the Electrical Industry" published by the German Electrical and Electronics Industry Association (ZVEI)**.
7. The trade names EPCOS, BAOKE, Alu-X, CeraDiode, CSSP, CTVS, DSSP, MiniBlue, MKK, MLSC, MotorCap, PCC, PhaseCap, PhaseMod, SIFERRIT, SIFI, SIKOREL, SilverCap, SIMDAD, SIMID, SineFormer, SIOV, SIP5D, SIP5K, ThermoFuse, WindCap are **trademarks registered or pending** in Europe and in other countries. Further information will be found on the Internet at www.epcos.com/trademarks.

Mouser Electronics

Authorized Distributor

Click to View Pricing, Inventory, Delivery & Lifecycle Information:

EPCOS:

[B43698A5685Q000](#) [B43698A5106Q000](#) [B43698A5156Q000](#) [B43698A5226Q000](#) [B43698A5336Q000](#)
[B43698A5685Q007](#) [B43698A5106Q007](#) [B43698A5156Q007](#) [B43698A5226Q007](#) [B43698A5336Q007](#)
[B43698A5685Q009](#) [B43698A5106Q009](#) [B43698A5156Q009](#)



Компания «ЭлектроПласт» предлагает заключение долгосрочных отношений при поставках импортных электронных компонентов на взаимовыгодных условиях!

Наши преимущества:

- Оперативные поставки широкого спектра электронных компонентов отечественного и импортного производства напрямую от производителей и с крупнейших мировых складов;
- Поставка более 17-ти миллионов наименований электронных компонентов;
- Поставка сложных, дефицитных, либо снятых с производства позиций;
- Оперативные сроки поставки под заказ (от 5 рабочих дней);
- Экспресс доставка в любую точку России;
- Техническая поддержка проекта, помощь в подборе аналогов, поставка прототипов;
- Система менеджмента качества сертифицирована по Международному стандарту ISO 9001;
- Лицензия ФСБ на осуществление работ с использованием сведений, составляющих государственную тайну;
- Поставка специализированных компонентов (Xilinx, Altera, Analog Devices, Intersil, Interpoint, Microsemi, Aeroflex, Peregrine, Syfer, Eurofarad, Texas Instrument, Miteq, Cobham, E2V, MA-COM, Hittite, Mini-Circuits, General Dynamics и др.);

Помимо этого, одним из направлений компании «ЭлектроПласт» является направление «Источники питания». Мы предлагаем Вам помощь Конструкторского отдела:

- Подбор оптимального решения, техническое обоснование при выборе компонента;
- Подбор аналогов;
- Консультации по применению компонента;
- Поставка образцов и прототипов;
- Техническая поддержка проекта;
- Защита от снятия компонента с производства.



Как с нами связаться

Телефон: 8 (812) 309 58 32 (многоканальный)

Факс: 8 (812) 320-02-42

Электронная почта: org@eplast1.ru

Адрес: 198099, г. Санкт-Петербург, ул. Калинина, дом 2, корпус 4, литера А.