

PLEASE CHECK WWW.MOLEX.COM FOR LATEST PART INFORMATION

Part Number: [1040460417](#)
Status: **Active**
Description: 2.00mm (.079") Pitch Wire-to-Board Header, Surface Mount, Single Row, Right Angle, 4 Circuits

Documents:

[3D Model](#) [Product Specification PS-104046-001 \(PDF\)](#)
[Drawing \(PDF\)](#) [RoHS Certificate of Compliance \(PDF\)](#)

Agency Certification

UL E29179

General

Product Family PCB Headers
 Series [104046](#)
 Application Wire-to-Board
 Comments for LED module
 Product Name N/A

Physical

Breakaway No
 Circuits (Loaded) 4
 Circuits (maximum) 4
 Color - Resin Natural
 Durability (mating cycles max) 30
 First Mate / Last Break No
 Flammability 94V-0
 Glow-Wire Compliant No
 Keying to Mating Part Yes
 Lock to Mating Part Yes
 Mated Height (in) 0.159 In
 Mated Height (mm) 4.05 mm
 Material - Metal Phosphor Bronze
 Material - Plating Mating Tin
 Material - Plating Termination Tin
 Number of Rows 1
 Orientation Right Angle
 PCB Locator No
 PCB Retention Yes
 Packaging Type Embossed Tape on Reel
 Pitch - Mating Interface (in) 0.079 In
 Pitch - Mating Interface (mm) 2.00 mm
 Polarized to Mating Part Yes
 Temperature Range - Operating -25°C to +135°C
 Termination Interface: Style Surface Mount

Electrical

Current - Maximum per Contact 1A
 Voltage - Maximum 250V AC (RMS)/DC

Material Info

Reference - Drawing Numbers

Packaging Specification PK-104046-001
 Product Specification PS-104046-001
 Sales Drawing SD-104046-001, SD-104046-002

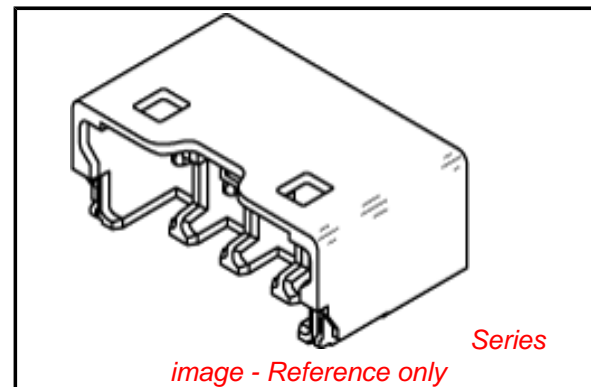

EU RoHS

ELV and RoHS Compliant
REACH SVHC Contains SVHC: No
Halogen-Free Status

China RoHS



Need more information on product environmental compliance?

Email productcompliance@molex.com
 For a multiple part number RoHS Certificate of Compliance, [click here](#)

Please visit the [Contact Us](#) section for any non-product compliance questions.

Search Parts in this Series

[104046Series](#)

Mates With

[104047 Crimp Housing](#) . [104466 Crimp Terminal](#)

This document was generated on 05/18/2010

PLEASE CHECK WWW.MOLEX.COM FOR LATEST PART INFORMATION

10 9 8 7 6 5 4 3 2 1

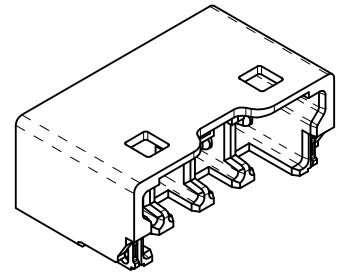
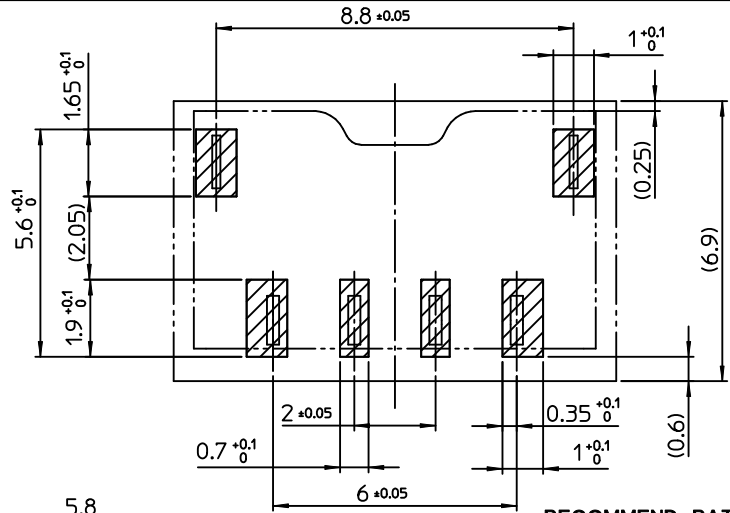
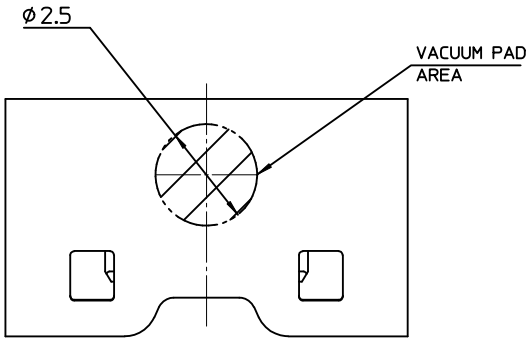

ISO METRIC VIEW

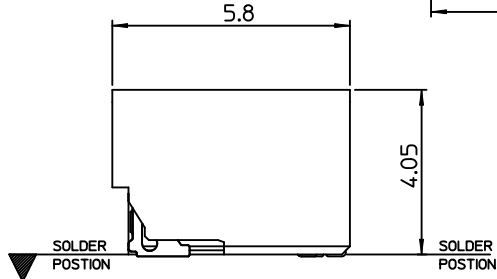
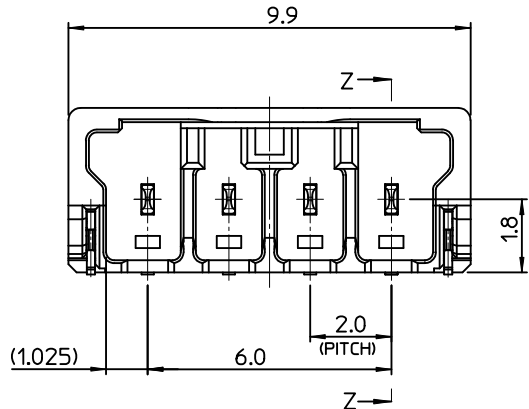

RECOMMEND PATTERN [REF.]

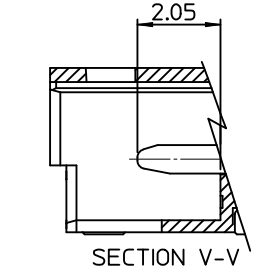
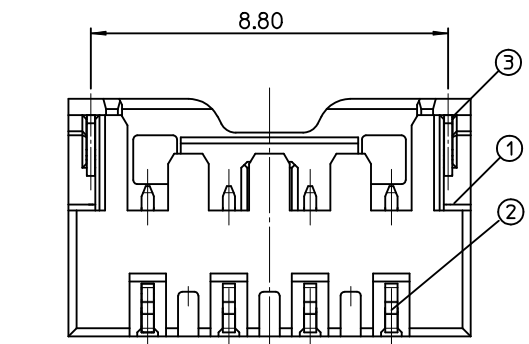
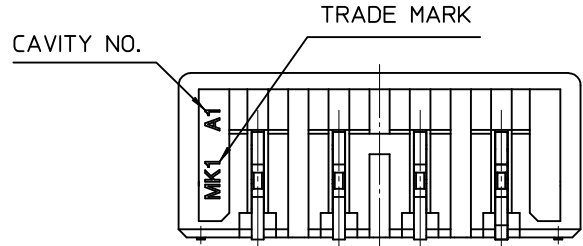

SECTION V-V

NOTES.

- MATED WITH : 104047-0490
- MATERIALS
 HEADER : LCP, GLASS FILLED, UL94V-0
 COLOR OF NATURAL
 CONTACT TERMINAL : POSPHOR BRONZE
 FITTING NAIL : PHOSPHOR BRONZE

3. FINISHES

- CONTACT TERMINAL : PURE-TIN PLATING ON OVERALL.
 THICKNESS 3.0µm~5.0µm
 UNDER PLATING Ni OVERALL.
 THICKNESS 1.25µm~3.75µm
- FITTING NAIL : PURE-TIN PLATING ON OVERALL.
 THICKNESS 3.0µm~5.0µm
 UNDER PLATING Ni OVERALL.
 THICKNESS 1.25µm~3.75µm

- PRODUCT SPECIFICATION No. : PS-104046-001
- PACKAGING SPECIFICATION No. : PK-104046-001

3	FITTING NAIL	104465-8002	4
2	CONTACT TERMINAL	104464-8002	
1	HEADER	104046-0490	
NO	PART NAME	MATERIAL NO.	CKT

REVISED	EC NO: KOR2010-0143	2010/03/23	DESCRIPTION
	DRWN: JHPARK01	2010/03/25	
	CHKD: W.YANG		
	APPR: YUNSIKKIM	2010/03/25	
REV	QUALITY SYMBOLS		
	▽=0		
	▽C=0		

GENERAL TOLERANCES (UNLESS SPECIFIED)	mm	INCH
	4 PLACES ± ---	± ---
	3 PLACES ± ---	± ---
	2 PLACES ± 0.20	± ---
	1 PLACE ± 0.25	± ---
	ANGULAR ± 3 °	
DRAFT WHERE APPLICABLE MUST REMAIN WITHIN DIMENSIONS		

DIMENSION STYLE		SCALE	DESIGN UNITS	THIRD ANGLE PROJECTION
MM ONLY		8:1	METRIC	
DRAWN BY	DATE	TITLE		
SK.HAN	2009/03/11	2.0 W-T-B CONN. HEADER ASS'Y-4P		
CHECKED BY	DATE			
WY.YANG	2009/03/11			
APPROVED BY	DATE			
WY.YANG	2009/03/11			
MATERIAL NO.		DOCUMENT NO.		
1040460417		SD-104046-001		
SIZE	THIS DRAWING CONTAINS INFORMATION THAT IS PROPRIETARY TO MOLEX INCORPORATED AND SHOULD NOT BE USED WITHOUT WRITTEN PERMISSION			
A3				

MOLEX INCORPORATED		SHEET NO.
		1 OF 01

9 8 7 6 5 4 3 2 1

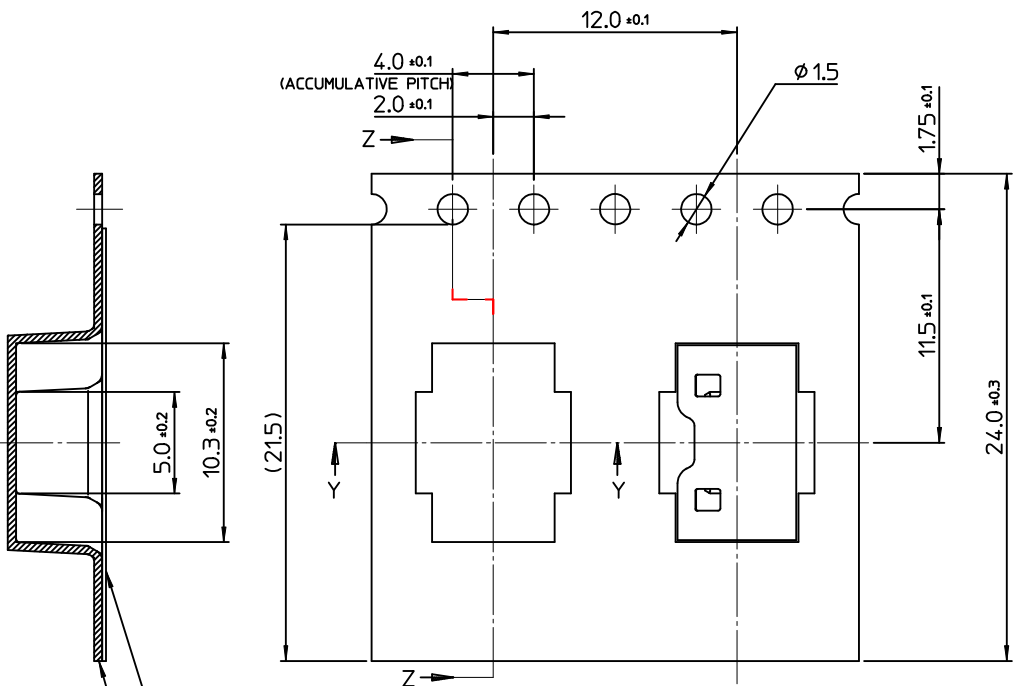

SECTION Z-Z

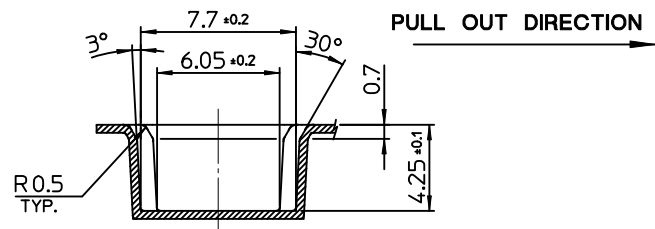
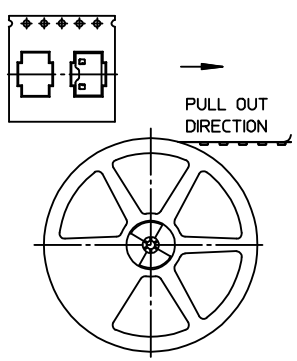

SECTION Y-Y

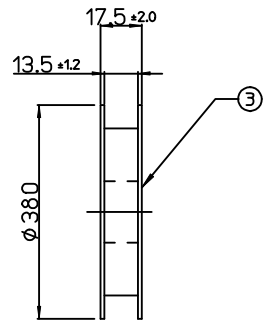

PLASTIC BOBBIN

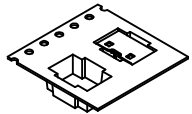

NOTES

1. QUANTITY OF CONNECTORS : 1500 PCS/REEL
2. LEAD LENGTH
3. PEELING OFF FORCE OF COVER TAPE : 0.1N~0.59N(10.2GF~60GF)
 (PEELING DIRECTION AS SHOW IN FOLLOW FIG.)
 PEELING OFF SPEED : 300mm/Min.(Ref.)
4. FLASH IN ANY PORTION SHOULD BE LESS THAN 0.20mm MAX.
5. UNLESS OTHERWISE SPECIFIED INNER R0.2 MAX
6. DRAFT ANGLE 3°MAX

[TABLE]

1040460417	104046-0417	24.0mm	104046-9004
MATERIAL NO.	CONNECTOR	TAPE WIDTH	EMBOSS TAPE

3	PLASTIC BOBBIN	HI P.S	WHITE
2	COVER TAPE	PET ANTISTATIC	21.3m
1	CARRIER (EMBOSS) TAPE	PET ANTISTATIC	
NO.	DESCRIPTION	MATERIAL	REMARK

NEW RELEASED EC NO: KOR2010-0066 DRWN:CBCHN 2009/10/15 CHKD:WYANG 2009/10/20 APPR:YUNSIKIM 2009/10/21	QUALITY SYMBOLS ▽=0 ▽=0	GENERAL TOLERANCES (UNLESS SPECIFIED)		DIMENSION STYLE MM ONLY		SCALE 4:1	DESIGN UNITS METRIC	THIRD ANGLE PROJECTION		
		4 PLACES ± --- ± ---	3 PLACES ± --- ± ---	2 PLACES ± 0.20 ± ---	1 PLACE ± 0.25 ± ---	DRAWN BY SK.HAN	DATE 2009/03/11	TITLE EMBOSSED PACKAGE 20 W-T-B CONN HEADER ASS'Y-4P		
		ANGULAR ± 3 °				CHECKED BY WY.YANG	DATE 2009/03/11	MOLEX INCORPORATED		
		DRAFT WHERE APPLICABLE MUST REMAIN WITHIN DIMENSIONS				APPROVED BY WY.YANG	DATE 2009/03/11	MATERIAL NO. SEE TABLE	DOCUMENT NO. SD-104046-002	SHEET NO. 1 OF 01



Компания «ЭлектроПласт» предлагает заключение долгосрочных отношений при поставках импортных электронных компонентов на взаимовыгодных условиях!

Наши преимущества:

- Оперативные поставки широкого спектра электронных компонентов отечественного и импортного производства напрямую от производителей и с крупнейших мировых складов;
- Поставка более 17-ти миллионов наименований электронных компонентов;
- Поставка сложных, дефицитных, либо снятых с производства позиций;
- Оперативные сроки поставки под заказ (от 5 рабочих дней);
- Экспресс доставка в любую точку России;
- Техническая поддержка проекта, помощь в подборе аналогов, поставка прототипов;
- Система менеджмента качества сертифицирована по Международному стандарту ISO 9001;
- Лицензия ФСБ на осуществление работ с использованием сведений, составляющих государственную тайну;
- Поставка специализированных компонентов (Xilinx, Altera, Analog Devices, Intersil, Interpoint, Microsemi, Aeroflex, Peregrine, Syfer, Eurofarad, Texas Instrument, Miteq, Cobham, E2V, MA-COM, Hittite, Mini-Circuits, General Dynamics и др.);

Помимо этого, одним из направлений компании «ЭлектроПласт» является направление «Источники питания». Мы предлагаем Вам помощь Конструкторского отдела:

- Подбор оптимального решения, техническое обоснование при выборе компонента;
- Подбор аналогов;
- Консультации по применению компонента;
- Поставка образцов и прототипов;
- Техническая поддержка проекта;
- Защита от снятия компонента с производства.



Как с нами связаться

Телефон: 8 (812) 309 58 32 (многоканальный)

Факс: 8 (812) 320-02-42

Электронная почта: org@eplast1.ru

Адрес: 198099, г. Санкт-Петербург, ул. Калинина, дом 2, корпус 4, литера А.