

Standard type:  (AQV256) / Reinforced type:  (AQV253H, AQV254H)   (AQV256H)

**DIP6-pin type with
low on-resistance and
reinforced insulation**

**PhotoMOS[®]
HE 1 Form A
(AQV250, AQV250H)**

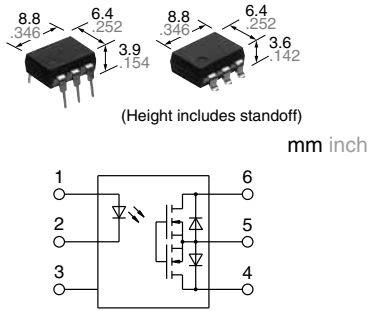

RoHS compliant

FEATURES

1. Wide variation of 40V, 60V, 100V, 200V, 250V, 400V, 600V, 1,000V and 1,500V load voltage
2. Low on-resistance of Typ. 0.6Ω (AQV251)
3. Reinforced insulation type of 5,000Vrms I/O isolation available

TYPICAL APPLICATIONS

- Measuring instruments
- Data communication equipment
- Telephone equipment
- Automatic meter reading device

TYPES

| | I/O isolation | Output rating* | | Package | Part No. | | | | Packing quantity | |
|----------------|----------------------|----------------|--------------|----------|-----------------------|--------------------------------|--------------------------------|-----------|--|-----------------------------|
| | | | | | Through hole terminal | Surface-mount terminal | | Tube | Tape and reel | |
| | | | | | | Tube packing style | | | | Tape and reel packing style |
| | | Load voltage | Load current | | | Picked from the 1/2/3-pin side | Picked from the 4/5/6-pin side | | | |
| AC/DC dual use | 1,500Vrms | 40 V | 500 mA | DIP6-pin | AQV251 | AQV251A | AQV251AX | AQV251AZ | 1 tube contains: 50 pcs. 1 batch contains: 500 pcs. | 1,000 pcs. |
| | | 60 V | 400 mA | | AQV252 | AQV252A | AQV252AX | AQV252AZ | | |
| | | 100 V | 350 mA | | AQV255 | AQV255A | AQV255AX | AQV255AZ | | |
| | | 200 V | 250 mA | | AQV257 | AQV257A | AQV257AX | AQV257AZ | | |
| | | 250 V | 200 mA | | AQV253 | AQV253A | AQV253AX | AQV253AZ | | |
| | | 400 V | 150 mA | | AQV254 | AQV254A | AQV254AX | AQV254AZ | | |
| | | 1,000 V | 30 mA | | AQV259 | AQV259A | AQV259AX | AQV259AZ | | |
| | | 1,500 V | 20 mA | | AQV258 | AQV258A | AQV258AX | AQV258AZ | | |
| | Reinforced 5,000Vrms | 250 V | 200 mA | | AQV253H | AQV253HA | AQV253HAX | AQV253HAZ | | |
| | | 400 V | 150 mA | | AQV254H | AQV254HA | AQV254HAX | AQV254HAZ | | |
| | | 600 V | 130 mA | | AQV256H | AQV256HA | AQV256HAX | AQV256HAZ | | |

*Indicate the peak AC and DC values.

Note: The surface mount terminal indicator "A" and the packing style indicator "X" or "Z" are not marked on the device.

RATING

1. Absolute maximum ratings (Ambient temperature: 25°C 77°F)

| Item | | Sym- bol | Type of connec- tion | AQV251(A) | AQV252(A) | AQV255(A) | AQV257(A) | AQV253(A) | AQV254(A) | AQV259(A) | AQV258(A) | AQV253H(A) | AQV254H(A) | AQV256H(A) | Remarks | |
|-------------------------|-------------------------|-------------|----------------------------|-----------------------------|-----------|-----------|-----------|-----------|-----------|------------|-----------|------------|------------|------------|---|----------------------------------|
| Input | LED forward current | I_F | | 50 mA | | | | | | | | | | | | |
| | LED reverse voltage | V_R | | 5 V | | | | | | | | | | | | |
| | Peak forward current | I_{FP} | | 1 A | | | | | | | | | | | | f = 100 Hz, Duty factor +0.1% |
| | Power dissipation | P_{in} | | 75 mW | | | | | | | | | | | | |
| Load voltage (peak AC) | | V_L | | 40V | 60V | 100V | 200V | 250V | 400V | 1,000V | 1,500V | 250V | 400V | 600V | | |
| Output | Continuous load current | I_L | A | 0.5A | 0.4A | 0.35A | 0.25A | 0.2A | 0.15A | 0.03A | 0.02A | 0.2A | 0.15A | 0.13A | A connection: Peak AC, DC B, C connection: DC | |
| | | | B | 0.7A | 0.6A | 0.45A | 0.35A | 0.3A | 0.18A | 0.04A | 0.025A | 0.3A | 0.18A | 0.14A | | |
| | | | C | 1.0A | 0.8A | 0.70A | 0.5A | 0.4A | 0.25A | 0.05A | 0.04A | 0.4A | 0.25A | 0.16A | | |
| | Peak load current | I_{peak} | | 1.8A | 1.5A | 1.0A | 0.75A | 0.6A | 0.5A | 0.09A | 0.06A | 0.6A | 0.5A | 0.4A | A connection: 100 ms (1 shot) $V_L = DC$ | |
| Power dissipation | | P_{out} | | 360 mW | | | | | | | | | | | | |
| Total power dissipation | | P_T | | 410 mW | | | | | | | | | | | | |
| I/O isolation voltage | | V_{iso} | | 1,500 Vrms | | | | | | 5,000 Vrms | | | | | | |
| Ambient temperature | Operating | T_{opr} | | -40 to +85°C -40 to +185°F | | | | | | | | | | | (Non-icing at low temperatures) | |
| | Storage | T_{stg} | | -40 to +100°C -40 to +212°F | | | | | | | | | | | | |

2. Electrical characteristics (Ambient temperature: 25°C 77°F)

| Item | | Sym- bol | Type of connec- tion | AQV251(A) | AQV252(A) | AQV255(A) | AQV257(A) | AQV253(A) | AQV254(A) | AQV259(A) | AQV258(A) | AQV253H(A) | AQV254H(A) | AQV256H(A) | Condition | | |
|----------------------------------|----------------------|-------------|----------------------------|--|-----------|-----------|-----------|-----------|-----------|-----------|-----------|------------|------------|---|---|---|----------------------------------|
| Input | LED operate current | Typical | — | 0.9 mA | | | | | | | | 1.4 mA | | | | $I_L = \text{Max.}$ | |
| | | Maximum | | 3 mA | | | | | | | | | | | | | |
| | LED turn off current | Minimum | — | 0.4 mA | | | | | | | | | | | | $I_L = \text{Max.}$ | |
| | | Typical | | 0.8 mA | | | | | | 1.3 mA | | | | | | | |
| LED dropout voltage | Typical | V_F | — | 1.25 V (1.14 V at $I_F = 5 \text{ mA}$) | | | | | | | | | | | | $I_F = 50 \text{ mA}$ | |
| | Maximum | | | 1.5 V | | | | | | | | | | | | | |
| Output | On resistance | Typical | R_{on} | A | 0.6 Ω | 0.74 Ω | 1.8 Ω | 2.6 Ω | 5.5 Ω | 12.4 Ω | 85 Ω | 345 Ω | 5.5 Ω | 12.4 Ω | 20 Ω | $I_F = 5 \text{ mA}$ $I_L = \text{Max.}$ Within 1 s | |
| | | | | | Maximum | 1 Ω | 1.4 Ω | 2.5 Ω | 4 Ω | 8 Ω | 16 Ω | 200 Ω | 500 Ω | 8 Ω | 16 Ω | | 30 Ω |
| | | Typical | R_{on} | B | 0.3 Ω | 0.37 Ω | 0.9 Ω | 1.4 Ω | 2.7 Ω | 6.2 Ω | 60 Ω | 345 Ω | 2.7 Ω | 6.2 Ω | 15 Ω | $I_F = 5 \text{ mA}$ $I_L = \text{Max.}$ Within 1 s | |
| | | | | | Maximum | 0.5 Ω | 0.7 Ω | 1.25 Ω | 2 Ω | 4 Ω | 8 Ω | 100 Ω | 500 Ω | 4 Ω | 8 Ω | | 20 Ω |
| | Typical | R_{on} | C | 0.15 Ω | 0.18 Ω | 0.45 Ω | 0.7 Ω | 1.4 Ω | 3.1 Ω | 30 Ω | 160 Ω | 1.4 Ω | 3.1 Ω | 7.5 Ω | $I_F = 5 \text{ mA}$ $I_L = \text{Max.}$ Within 1 s | | |
| | | | | Maximum | 0.25 Ω | 0.35 Ω | 0.63 Ω | 1 Ω | 2 Ω | 4 Ω | 50 Ω | 250 Ω | 2 Ω | 4 Ω | | 10 Ω | |
| Off state leakage current | Maximum | I_{Leak} | — | 1 μA | | | | | | 10 μA | | 1 μA | | | $I_F = 0 \text{ mA}$ $V_L = \text{Max.}$ | | |
| Transfer characteristics | Turn on time* | Typical | T_{on} | — | 1.7 ms | 1.4 ms | 0.9 ms | 1.5 ms | 0.8 ms | 0.6 ms | 0.35 ms | 2.4 ms | 1.8 ms | 1.2 ms | $I_F = 5 \text{ mA}$ $I_L = \text{Max.}$ | | |
| | | Maximum | | | 3 ms | 2 ms | 3 ms | 2 ms | 1 ms | 4 ms | 3ms | | | | | | |
| | Turn off time* | Typical | T_{off} | — | 0.07 ms | 0.09 ms | 0.1 ms | 0.06 ms | 0.05 ms | 0.04 ms | 0.06 ms | 0.05 ms | 0.06 ms | $I_F = 5 \text{ mA}$ $I_L = \text{Max.}$ | | | |
| | | Maximum | | | 0.2 ms | | | | | | | | | | | | |
| | I/O capacitance | Typical | C_{iso} | — | 1.3 pF | | | | | | | | | | | | f = 1 MHz $V_B = 0 \text{ V}$ |
| | | Maximum | | | 3 pF | | | | | | | | | | | | |
| Initial I/O isolation resistance | Minimum | R_{iso} | — | 1,000 MΩ | | | | | | | | | | | | 500 V DC | |

*Turn on/Turn off time



3. Recommended operating conditions (Ambient temperature: 25°C 77°F)

Please use under recommended operating conditions to obtain expected characteristics.

| | Item | Symbol | Min. | Max. | Unit |
|------------|--|----------------|------|------|------|
| | LED current | I _F | 5 | 30 | mA |
| AQV251(A) | Load voltage (Peak AC) | V _L | — | 32 | V |
| | Continuous load current (A connection) | I _L | — | 0.5 | A |
| AQV252(A) | Load voltage (Peak AC) | V _L | — | 48 | V |
| | Continuous load current (A connection) | I _L | — | 0.4 | A |
| AQV255(A) | Load voltage (Peak AC) | V _L | — | 80 | V |
| | Continuous load current (A connection) | I _L | — | 0.35 | A |
| AQV257(A) | Load voltage (Peak AC) | V _L | — | 160 | V |
| | Continuous load current (A connection) | I _L | — | 0.25 | A |
| AQV253(A) | Load voltage (Peak AC) | V _L | — | 200 | V |
| | Continuous load current (A connection) | I _L | — | 0.2 | A |
| AQV254(A) | Load voltage (Peak AC) | V _L | — | 320 | V |
| | Continuous load current (A connection) | I _L | — | 0.15 | A |
| AQV259(A) | Load voltage (Peak AC) | V _L | — | 800 | V |
| | Continuous load current (A connection) | I _L | — | 0.03 | A |
| AQV258(A) | Load voltage (Peak AC) | V _L | — | 1200 | V |
| | Continuous load current (A connection) | I _L | — | 0.02 | A |
| AQV253H(A) | Load voltage (Peak AC) | V _L | — | 200 | V |
| | Continuous load current (A connection) | I _L | — | 0.2 | A |
| AQV254H(A) | Load voltage (Peak AC) | V _L | — | 320 | V |
| | Continuous load current (A connection) | I _L | — | 0.15 | A |
| AQV256H(A) | Load voltage (Peak AC) | V _L | — | 480 | V |
| | Continuous load current (A connection) | I _L | — | 0.13 | A |

■ **These products are not designed for automotive use.**

If you are considering to use these products for automotive applications, please contact your local Panasonic Corporation technical representative.

■ **Continual DC bias (for AQV258**, AQV259**)**

In cases in which a continual DC bias is applied between the input and output, the output-side MOS-FET may deteriorate due to the voltage. Therefore, please verify operation of the actual design before using. An example of a circuit that might undergo MOS-FET deterioration due to voltage is given below.

REFERENCE DATA

1.-(1) Load current vs. ambient temperature characteristics

Allowable ambient temperature: -40 to +85°C
-40 to +185°F ;

Type of connection: A



1.-(2) Load current vs. ambient temperature characteristics

Allowable ambient temperature: -40 to +85°C
-40 to +185°F ;

Type of connection: A



2.-(1) On resistance vs. ambient temperature characteristics

Measured portion: between terminals 4 and 6;
LED current: 5 mA;
Continuous load current: Max. (DC)



2.-(2) On resistance vs. ambient temperature characteristics

Measured portion: between terminals 4 and 6;
LED current: 5 mA;
Continuous load current: Max. (DC)



2.-(3) On resistance vs. ambient temperature characteristics

Measured portion: between terminals 4 and 6;
LED current: 5 mA;
Continuous load current: 30 mA (DC)



3.-(1) Turn on time vs. ambient temperature characteristics

LED current: 5 mA;
Load voltage: Max. (DC);
Continuous load current: Max. (DC)



HE 1 Form A (AQV25○, AQV25○H)

3.-(2) Turn on time vs. ambient temperature characteristics

LED current: 5 mA; Load voltage: Max. (DC);
Continuous load current: Max. (DC)



4.-(1) Turn off time vs. ambient temperature characteristics

LED current: 5 mA; Load voltage: Max. (DC);
Continuous load current: Max. (DC)



4.-(2) Turn off time vs. ambient temperature characteristics

Sample: AQV253H, AQV254H, AQV256H
LED current: 5 mA; Load voltage: Max. (DC);
Continuous load current: Max. (DC)



5.-(1) LED operate current vs. ambient temperature characteristics

Sample: AQV251, AQV252, AQV253, AQV254, AQV255, AQV257, AQV258, AQV259; Load voltage: Max. (DC); Continuous load current: Max. (DC)

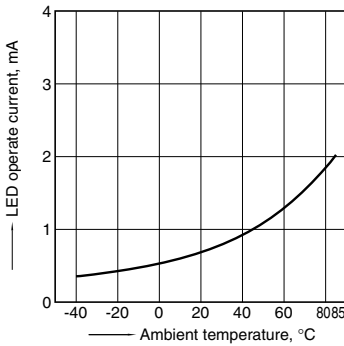

5.-(2) LED operate current vs. ambient temperature characteristics

Sample: AQV253H, AQV254H, AQV256H; Load voltage: Max. (DC); Continuous load current: Max. (DC)



6.-(1) LED turn off current vs. ambient temperature characteristics

Sample: AQV251, AQV252, AQV253, AQV254, AQV255, AQV257, AQV258, AQV259; Load voltage: Max. (DC); Continuous load current: Max. (DC)



6.-(2) LED turn off current vs. ambient temperature characteristics

Sample: AQV253H, AQV254H, AQV256H; Load voltage: Max. (DC); Continuous load current: Max. (DC)

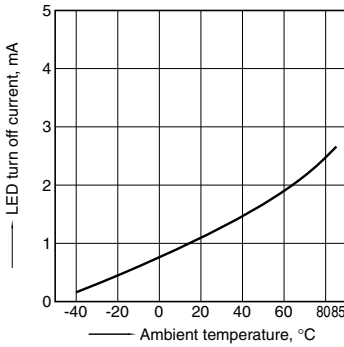

7. LED dropout voltage vs. ambient temperature characteristics

LED current: 5 to 50 mA

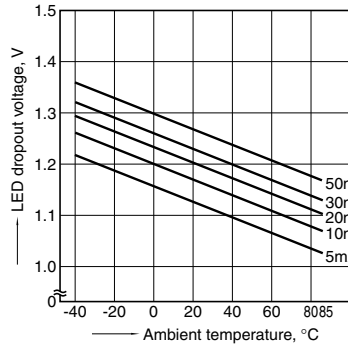

8.-(1) Current vs. voltage characteristics of output at MOS portion

Measured portion: between terminals 4 and 6;
Ambient temperature: 25°C 77°F

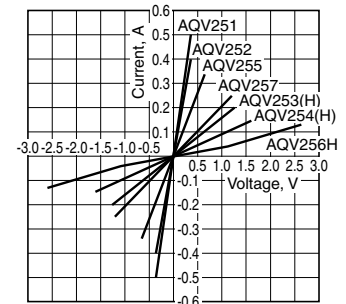

8.-(2) Current vs. voltage characteristics of output at MOS portion

Measured portion: between terminals 4 and 6;
Ambient temperature: 25°C 77°F

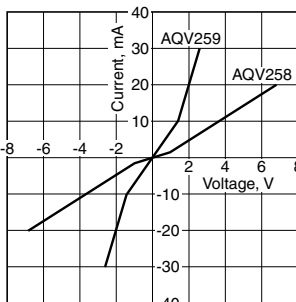

9.-(1) Off state leakage current vs. load voltage characteristics

Sample: AQV259; Measured portion: between terminals 4 and 6;
Ambient temperature: 25°C 77°F

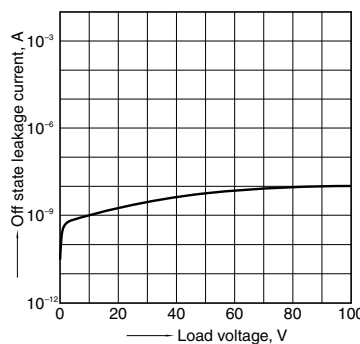

9.-(2) Off state leakage current vs. load voltage characteristics

Measured portion: between terminals 4 and 6;
Ambient temperature: 25°C 77°F

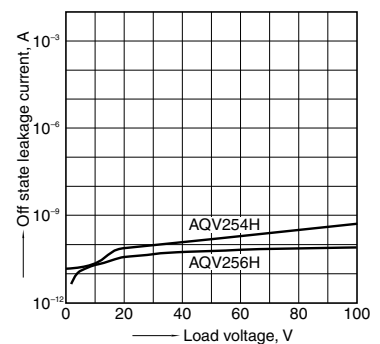

10-(1). Turn on time vs. LED forward current characteristics

Measured portion: between terminals 4 and 6;
Load voltage: Max. (DC); Continuous load current: Max. (DC); Ambient temperature: 25°C 77°F



10-(2). Turn on time vs. LED forward current characteristics

Measured portion: between terminals 4 and 6;
Load voltage: Max. (DC); Continuous load current: Max. (DC); Ambient temperature: 25°C 77°F



11-(1). Turn off time vs. LED forward current characteristics

Measured portion: between terminals 4 and 6;
Load voltage: Max. (DC); Continuous load current: Max. (DC); Ambient temperature: 25°C 77°F



11-(2). Turn off time vs. LED forward current characteristics

Measured portion: between terminals 4 and 6;
Load voltage: Max. (DC); Continuous load current: Max. (DC); Ambient temperature: 25°C 77°F



12-(1) Output capacitance vs. applied voltage characteristics

Measured portion: between terminals 4 and 6;
Frequency: 1 MHz;
Ambient temperature: 25°C 77°F



12-(2) Output capacitance vs. applied voltage characteristics

Sample: AQV259;
Measured portion: between terminals 4 and 6;
Frequency: 1 MHz; Ambient temperature: 25°C 77°F

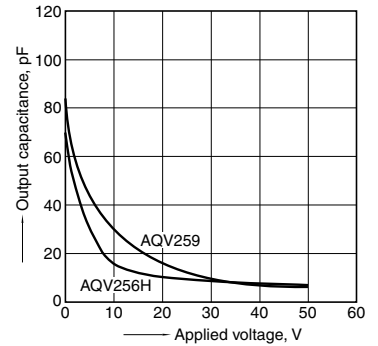

"PhotoMOS®", "PhotoMOS" and "PHOTOMOS" are registered trademarks of Panasonic Corporation.

*Recognized in Japan, the United States, all member states of European Union and other countries.

Please contact

Panasonic Corporation

Electromechanical Control Business Division

■ 1006, Oaza Kadoma, Kadoma-shi, Osaka 571-8506, Japan
industrial.panasonic.com/ac/e/

Panasonic®

©Panasonic Corporation 2017

Mouser Electronics

Authorized Distributor

Click to View Pricing, Inventory, Delivery & Lifecycle Information:

Panasonic:

[AQV252](#) [AQV252A](#) [AQV253](#) [AQV254A](#) [AQV254H](#) [AQV257](#) [AQV257A](#) [AQV258A](#) [AQV259A](#) [AQV258AX](#)
[AQV259](#) [AQV253H](#) [AQV258](#) [AQV254](#)



Компания «ЭлектроПласт» предлагает заключение долгосрочных отношений при поставках импортных электронных компонентов на взаимовыгодных условиях!

Наши преимущества:

- Оперативные поставки широкого спектра электронных компонентов отечественного и импортного производства напрямую от производителей и с крупнейших мировых складов;
- Поставка более 17-ти миллионов наименований электронных компонентов;
- Поставка сложных, дефицитных, либо снятых с производства позиций;
- Оперативные сроки поставки под заказ (от 5 рабочих дней);
- Экспресс доставка в любую точку России;
- Техническая поддержка проекта, помощь в подборе аналогов, поставка прототипов;
- Система менеджмента качества сертифицирована по Международному стандарту ISO 9001;
- Лицензия ФСБ на осуществление работ с использованием сведений, составляющих государственную тайну;
- Поставка специализированных компонентов (Xilinx, Altera, Analog Devices, Intersil, Interpoint, Microsemi, Aeroflex, Peregrine, Syfer, Eurofarad, Texas Instrument, Miteq, Cobham, E2V, MA-COM, Hittite, Mini-Circuits, General Dynamics и др.);

Помимо этого, одним из направлений компании «ЭлектроПласт» является направление «Источники питания». Мы предлагаем Вам помощь Конструкторского отдела:

- Подбор оптимального решения, техническое обоснование при выборе компонента;
- Подбор аналогов;
- Консультации по применению компонента;
- Поставка образцов и прототипов;
- Техническая поддержка проекта;
- Защита от снятия компонента с производства.



Как с нами связаться

Телефон: 8 (812) 309 58 32 (многоканальный)

Факс: 8 (812) 320-02-42

Электронная почта: org@eplast1.ru

Адрес: 198099, г. Санкт-Петербург, ул. Калинина, дом 2, корпус 4, литера А.